

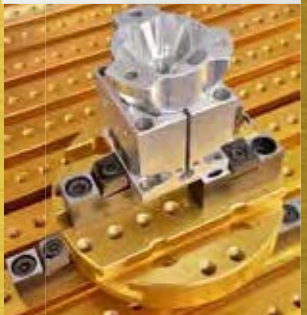

*Lion head machined by
TITANS OF CNC
using Machinable
Pitbull[®] Clamps*

See inside front cover
for more information

**NEW
ITEMS**



And more to come!
SEE PAGE 48



Mission Statement

Our goal is to serve our customers by providing a complete range of workholding solutions, of the highest quality at competitive prices and delivered on time. This promise is backed and supported by our knowledgeable sales and engineering staff who are available to assist our distributors and customers.

Company Profile

Mitee-Bite Products, LLC began in 1986 in an oversized 2 car garage with the original Mitee-Bite hex clamp created to save time on a reoccurring production job and grew to become the innovator of compact, low-profile edge clamps for CNC machining.

Fast forward more than 30 years later and we continue to develop new products providing customers with a wide assortment of high-density low profile clamping solutions and assistance with clamping recommendations. We have expanded to also provide top level CAD designs and complete turn-key projects.

We place our focus on what matters most on your shop floor... MAKING CHIPS! Keeping the spindle running, cutter engagement, reducing idle spindle time, saving on material cost, reducing set-up times and standardization, all contribute to our belief "let the machines work harder while you lower your labor cost and increase capacity."

Mitee-Bite Products are available through many qualified distributors around the world. For contact and product information visit our website at MiteeBite.com.

Our goal is to help you reach your goals.

Our CAD FILES can now be downloaded in all formats from our website:
MiteeBite.com



Cover image is a CAD rendering machined out of 6AL-4V titanium using 10 of our Machinable Pitbull® Clamps, providing over 100,000 lbs. of holding force. Machined by our friends at ***Titans of CNC***



Visit
academy.titanofcnc.com
for the most comprehensive
free online CNC tutorials.



Scan the QR codes located throughout the catalog to see videos and learn more about our products!

Table of Contents

4TH & 5TH AXIS

Loc-Jaw® System	36
Modular In-Line Clamping System NEW	16
Tall Vise Jaws/Towers NEW	37

ACCESSORIES

Chip Hook	45
Collet Stop	44
Collet Wrench	44

CAM ACTION

Compact Toe Clamp	6
Fixture Clamp	4
Knife Edge Clamp	4
Machinable Fixture Clamp	5
Series-9 Clamp	5

HEAT ACTIVATED

Mitee-Grip™	21
-----------------------	----

INTERNAL

ID Xpansion™ Clamp	22-23
Manual Actuators for Mills and Lathes	25
Modular XYZ Xpansion™ Pins NEW	26-27
Side-Loc Xpansion® Clamp	24

INTERNAL PULL-DOWN

Loc-Down® System	28
----------------------------	----

LOW PROFILE

Kopal® Mini Clamp	20
Machinable Pitbull® Clamp	13
Pitbull® Clamp	14-15
Spring Loc™ and Sliding Stop™ NEW	43
Strap Clamp	44
TalonGrip™ Vise Jaw	34
VersaGrip™ Vise Jaw	35

MODULAR

Modular In-Line Clamping System NEW	16
Modular Pitbull® Clamp	13
Multi-Fixture Clamps and Stops	17
OK-VISE® Multi-Rail System NEW	12
T-Slot Toe Clamp	6
T-Slot and Advant-Edge Clamp	7

PALLET CHANGER

Quick Change Receiver and Blank Pallet NEW	29
Vacmagic® VM100	30
Vacmagic® VM300	31
Vise Pallet	41

PRECISE LOCATORS

Locating Pins and Liners	43
Locating Rails for Jigs and Fixtures	40

RAMP

Dyna-Force® Clamp	18-19
-----------------------------	-------

ROCKING LEVER

Mounting Clamp	43
--------------------------	----

VACUUM

Multi-Power Vac	32
Rotary Vacuum Chuck NEW	33
Vacmagic® VM100	30
Vacmagic® VM300	31
Vacuum Pump NEW	45

WEDGE

Long Length Machinable Uniforce® Clamp	9
Long Length Uniforce® Channel & Steel	8
Machinable Uniforce® Clamp	9
OK-VISE® Clamp	10-12
Uniforce® Clamp	8

WORKSTATION PLATFORM

Aluminum T-Slot Plate	42
T-Nut Rail	42

WORM-AND-GEAR

Kopal® Clamps	38-39
Mono-Bloc Chain Clamp	39

Replacement Parts	46-47
-----------------------------	-------

NEW ITEMS Available Soon! 48

Index	49
-----------------	----

Customer Applications	50-51
---------------------------------	-------

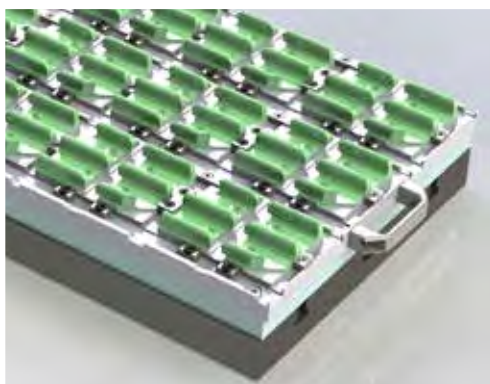

Original Fixture Clamps



The cam action MITEE-BITE Fixture Clamp is made up of two simple components: a hardened steel socket cap screw with an offset head and a brass hexagonal washer.

- ▶ Low-profile for quick and easy installation of linear motion guide rails
- ▶ Cam action provides fast, strong clamping
- ▶ Small size allows more parts per load
- ▶ Simple design keeps cost low



- ▶ 50218 our most popular LMGR size available in bulk

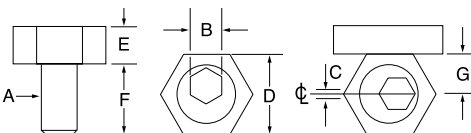

G* - Location to drill and tap from edge of workpiece.

NOTE: Clockwise rotation is recommended. Locating pin should be on the right of workpiece.



Part Number	A	B	C	D	E	F	G*	Torque (Ft/Lbs)	Holding Force	Clamps Per Pack*	—Replacement—		
											Cam Screw	Hex Washer	
Torque (N.m.)													
INCH	10202	8 - 32	5/64	.030	.312	.110	.350	.150	1.5	205 lbs	10	10363	10580
	10207	10 - 32	3/32	.040	.500	.160	.340	.250	2.5	350 lbs	10	10366	10587
	10204	1/4 - 20	1/8	.040	.625	.190	.470	.308	6.2	800 lbs	10	10365	10582
	10205	5/16 - 24	3/16	.040	.812	.180	.460	.400	8.3	800 lbs	12	10369	10584
	10201	5/16 - 18	3/16	.040	.812	.180	.460	.400	8.3	800 lbs	12	10367	10584
	10206	3/8 - 16	3/16	.050	.812	.250	.710	.400	20.8	2,000 lbs	10	10371	10586
	10208	1/2 - 13	5/16	.100	1.000	.375	.900	.500	65.0	4,000 lbs	8	10373	10588
	10210	5/8 - 11	3/8	.100	1.187	.500	1.125	.590	100.0	6,000 lbs	4	10375	10592
METRIC	50204	M4	3	.76	7.93	2.80	9.6	3.80	2.0	910 N	10	50363	10580
	50206	M6	4	1.01	15.86	4.75	11.2	7.80	8.5	3,558 N	10	50365	10582
	50208	M8	5	1.01	20.61	4.55	15.0	10.15	11.3	3,558 N	12	50367	10584
	50210	M10	7	1.27	20.61	6.35	19.0	10.15	28.0	8,895 N	10	50369	10586
	50212	M12	8	2.03	25.38	9.52	22.8	12.70	88.0	17,790 N	8	50371	10590
	50216	M16	12	2.54	30.13	12.70	28.5	15.00	125.0	26,680 N	4	50373	10592
	50218	M8	5	1.01	20.61	4.55	15.0	10.15	11.3	3,558 N	bulk	502181	10584
STAINLESS STEEL (300 Series)													
	10214	8 - 32	5/64	.030	.312	.110	.350	.150	1.5 Ft. Lbs	205 lbs	4	10362	10581
	10203	1/4 - 20	1/8	.040	.625	.190	.470	.308	6.2 Ft. Lbs	800 lbs	4	10364	10583
	10213	5/16 - 18	3/16	.040	.812	.250	.460	.400	8.3 Ft. Lbs	800 lbs	4	10368	10585
	50214	M4	3mm	.76mm	7.93mm	2.80mm	9.6mm	3.80mm	2.0(N.m.)	910 N	4	50361	10581
	50205	M6	4mm	1.01mm	15.86mm	4.75mm	11.2mm	7.80mm	8.50(N.m.)	3,558 N	4	50364	10583
	50207	M8	5mm	1.01mm	20.60mm	6.35mm	15.0mm	10.15mm	11.30(N.m.)	3,558 N	4	50366	10585

* - All clamps may be purchased in bulk packages of 50 pcs. or more.

Knife Edge Clamps



Our Knife Edge Clamps can be used instead of the original brass hex clamps for clamping rough cut stock, castings and any material that requires a hardened clamping element. Same "G" dimension as Original Fixture Clamps above. Clamps produced in 12L14 steel with a nickel coating.

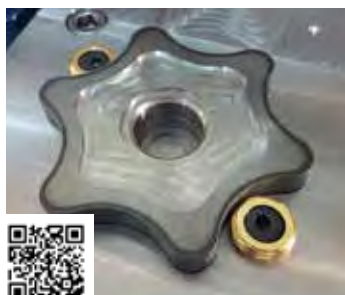
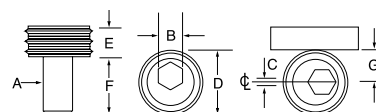

Part Number	A	B	C	D	E	F	G	Max. Torque (Ft/Lbs)	Holding Force (Lbs)	Number of Clamps Per Pack	— Replacement —		
											Cam Screw	Washer	
(N.m.) (N.)													
INCH	22584	3/8 - 16	3/16	.050	.812	.250	.710	.400	16.6	2,000	8	10371	12584
	22588B	1/2 - 13	5/16	.080	1.000	.375	.900	.500	52.0	4,000	8	10374	12588B
	22592	5/8 - 11	3/8	.100	1.187	.500	1.125	.590	80.0	6,000	4	10375	12592
METRIC	82584	M10	7M	1.27	20.60	6.35	19.0	10.15	28.00	8900	8	50369	12584
	82588	M12	8M	2.03	25.40	9.52	22.70	12.70	88.00	17800	8	50371	12588B
	82592	M16	12M	2.54	30.15	12.70	28.5	15.00	135.00	26700	4	50373	12592

Not designed for clamping hardened material at maximum torque.

Series-9 Clamps



This adjustable low profile, cam action clamp provides clamping of different size workpieces merely by rotating the clamp to one of its other edges. The clamps are .394 (10mm) high and use a 1/2-13 (M12) cam screw. Each of the six clamping surfaces is a different distance from the centerline by .0394 (1mm) as shown in the chart. Therefore, one Series-9 Clamp can hold parts that vary up to .240 (9.4mm) simply by rotating the clamp to a different clamping surface.

- ▶ Serrated or smooth edges
- ▶ Heat treated and plated
- ▶ 4,000 lbs. (17800 N.m.) holding force

TORQUE VALUES AND HOLDING FORCE

	Part Numbers	Use Screw Size	Max. Torque/ Holding Force	Replacement Cam Screw
INCH	90110 - 90145	1/2 - 13	65 Ft Lbs / 4000 Lbs	10374
METRIC	95110 - 95145	M12	88 N.m. / 17,800 N.	50371

—Part Number—		Description	Face Number	Distance from ϕ (metric)
Inch	Metric			
90110	95110	1-6 Smooth	1	.4724 (12mm)
90115	95115	1-6 Serrated	2	.5118 (13mm)
			3	.5512 (14mm)
			4	.5906 (15mm)
			5	.6299 (16mm)
			6	.6693 (17mm)
90120	95120	7-12 Smooth	7	.7086 (18mm)
90125	95125	7-12 Serrated	8	.7480 (19mm)
			9	.7874 (20mm)
			10	.8268 (21mm)
			11	.8661 (22mm)
			12	.9055 (23mm)

—Part Number—		Description	Face Number	Distance from ϕ (metric)
Inch	Metric			
90130	95130	13-18 Smooth	13	.9449 (24mm)
90135	95135	13-18 Serrated	14	.9842 (25mm)
			15	1.0236 (26mm)
			16	1.0630 (27mm)
			17	1.1024 (28mm)
			18	1.1417 (29mm)
90140	95140	19-24 Smooth	19	1.1811 (30mm)
90145	95145	19-24 Serrated	20	1.2205 (31mm)
			21	1.2598 (32mm)
			22	1.2992 (33mm)
			23	1.3386 (34mm)
			24	1.3780 (35mm)

Machinable Fixture Clamps



These clamps, with the machinable steel washers, provide more flexibility for holding round or unusual shaped parts. Parts can be held directly to the fixture plate surface or elevated for through drilling. A special screw is provided with each package to hold the washer in the proper place during machining.

The flat edge is the same location as our original fixture clamps. It can be used where a stronger clamping surface is required.

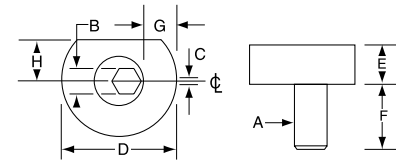

- ▶ Low profile
- ▶ Made of mild steel for machinability



Part Number	A	B	C	D	E	F	G*	H†	Max. Torque (Ft/Lbs)	Holding Force (Lbs)	Number of Clamps Per Pack	—Replacement— Cam Screw	Washer
INCH													
10504	1/4 - 20	1/8	.040	.980	.250	.470	.250	.312	6.2	800	4	10365	10604
10506	3/8 - 16	3/16	.050	1.230	.350	.710	.275	.406	20.8	2,000	4	10371	10606
10508	1/2 - 13	5/16	.100	1.480	.450	.900	.300	.500	65.0	4,000	4	10373	10608
10510	5/8 - 11	3/8	.100	1.730	.550	1.125	.350	.593	100.0	6,000	4	10375	10610
									(N.m.)	(N.)			
METRIC													
50506	M6	4M	1.01	24.9	6.4	11.9	6.4	7.8	8.5	3358	4	50365	10604
50510	M10	7M	1.52	31.2	8.9	18.0	7.0	10.2	28.0	8900	4	50369	10606
50512	M12	8M	2.03	37.6	11.4	22.9	7.6	12.7	88.0	17800	4	50371	10612
50516	M16	12M	2.54	43.9	14.0	28.6	8.9	15.0	135.0	26700	4	50373	10610

G* - Amount of machinable stock H† - The distance to drill & tap hole from edge of workpiece to use flat face.
Every package includes one machining screw

Compact Toe Clamps



This cam action fixture clamp provides positive down force while using very little space on a fixture. Workpieces can be clamped in series by using the back surface of a clamp to locate the next workpiece. The hardened steel clamping element has both a smooth surface for machined workpieces and a serrated clamping surface for rougher work. The height of the clamp can be adjusted by milling the slot deeper in the fixture plate.

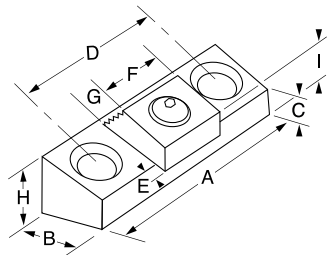

Part Number	A	B	C	D	E†	F	G	H	I*	Total Distance of Movement	Mounting Screws (Included)	Max. Torque (Ft/Lbs)	Holding Force (Lbs)	Replacement - Cam Screw	Replacement - Square Washer
INCH															
24106	1.70	.75	.50	1.00	.090	.75	.25	.62	.845	.050	5/16-18x3/4 LHCS	20.8	2,000	10370	21006
24108	2.12	1.00	.45	1.32	.110	1.00	.38	.62	.960	.100	3/8-16x3/4 LHCS	65.0	4,000	10372	21016
24110	2.95	1.50	.99	2.00	.130	1.50	.50	1.25	1.70	.100	1/2-13x1 1/4 SHCS	100.0	6,000	10376	21026
													(N.m.)	(N.)	
METRIC															
54110	43.2	19.0	12.7	25.4	2.3	19.0	6.4	15.75	21.5	1.6	M8x16 LHCS	28.20	8900	50368	21006
54112	54.0	25.4	11.4	33.5	2.8	25.4	9.7	15.75	24.4	2.0	M10x20 LHCS	88.13	17800	50372	51016
54116	75.0	38.1	25.2	50.8	3.3	38.1	12.7	31.75	43.2	2.5	M12x30 SHCS	135.58	26700	50374	21026

E† - The distance needed between the front of the clamp base and the workpiece. I* - The distance from the top of the washer to the bottom of the clamp body. Drill and tap the centerline of "B" for mounting holes.

T-Slot Toe Clamps



This clamp is like the Compact Toe Clamp, only it is designed to be used in the T-slots of machine tables. It provides 4,000 lbs. (17800 N) positive down force while maintaining a low profile. The hardened steel clamping element has both a smooth surface for machined workpieces and a serrated clamping surface for rougher work.

	A	B	C	D	E	F1	F2	G (Neutral Position)	Max. Torque/Holding Force
INCH	1.94	1.12	.62	1.00	.38	1.00	.875	1.48	65/4,000 (Ft Lbs/Lbs)
METRIC	50	28.5	15.7	25.4	9.6	25.4	22.2	37.59	88.00/17800 (N.m./N.)

F1 - The distance from the top of the back of the washer to the bottom of the clamp body. F2 - The distance from the top of the front of the washer to the bottom of the clamp body. Torque mounting bolt to 110 Ft/Lbs (150N.m.).

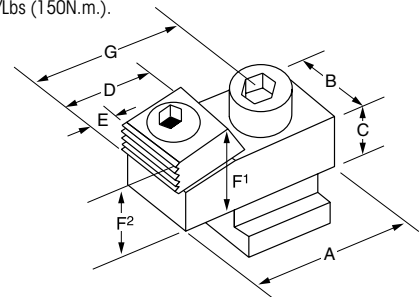

Part Number	T-slot Size
INCH 24000	No T-nut or Mtg. Screw
24128	9/16
24148	5/8
24168	1 1/16
24188	3/4
METRIC 54000	No T-nut or Mtg. Screw
54014	14
54016	16
54018	18

	Replacement	
	Cam Screw	Square Washer
INCH	10372	21016
METRIC	50372	51016



T-Slot and Advant-Edge Clamps



The original MITEE-BITE T-Slot Clamp combines our unique cam action clamping element with a T-nut.



- ▶ Locks in machine T-slot for low profile clamping
- ▶ Makes fast set-ups possible right on the machine table
- ▶ Brass hex follows contour of unusual shaped parts
- ▶ Packaged in pairs or complete kits

MITEE-BITE T-SLOT KITS (Contents: 4 Mitee-Bite T-Nuts, 6 Mitee-Bite Fixture Clamps, 2 Hex Keys)

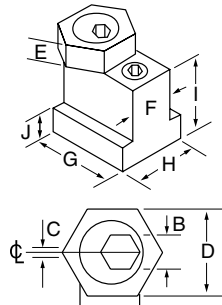

Part Number	Cam Screw	T-Slot Size	B	C	D	E	F	G	H	I	J	Max. Torque (Ft/Lbs)	Holding Force (Lbs)	Replacement		
														Cam Screw	Hex Washer	T-Nut
INCH																
10640	1/4-20	3/8	1/8	.040	.625	.190	.365	.89	.500	.375	.150	6.2	800	10365	10582	10714
10641	5/16-18	7/16	3/16	.040	.812	.190	.425	1.10	.625	.625	.220	8.3	800	10367	10584	10715
10642	3/8-16	1/2	3/16	.050	.812	.250	.490	1.20	.750	.625	.235	20.8	2,000	10371	10586	10716
10643	3/8-16	9/16	3/16	.050	.812	.250	.550	1.20	.875	.750	.300	20.8	2,000	10371	10586	10717
10644	1/2-13	5/8	5/16	.100	1.000	.375	.620	1.27	1.000	.875	.425	45.0	3,000	10373	10588	10718
10646	1/2-13	11/16	5/16	.100	1.000	.375	.675	1.37	1.000	1.000	.350	45.0	3,000	10373	10588	10719

Part Number	Cam Screw	T-Slot Size	B	C	D	E	F	G	H	I	J	Max. Holding Torque (N.m)	Holding Force (N)	Replacement		
														Cam Screw	Hex Washer	T-Nut
METRIC																
50642	M6 x 1.00	8mm	5mm	1.01	15.86	4.75	8	23.2	12.7	9.5	4.6	8.55	3,558	50365	10582	50708
50644	M6 x 1.00	10mm	5mm	1.01	15.86	4.75	10	23.2	14.2	14.2	4.3	8.55	3,558	50365	10582	50710
50646	M8 x 1.25	12mm	5mm	1.01	20.62	4.75	12	27.9	15.9	15.9	6.4	11.30	3,355	50367	10584	50712
50648	M10 x 1.50	14mm	7mm	1.52	20.62	6.35	14	30.5	22.4	22.2	8.5	28.00	8,895	50369	10586	50714
50650	M12 x 1.75	16mm	8mm	2.03	25.40	9.53	16	30.9	25.4	22.2	9.2	61.00	13,340	50371	10590	50716
50652	M12 x 1.75	18mm	8mm	2.03	25.40	9.53	18	34.7	28.6	28.6	10.5	61.00	13,340	50371	10590	50718
50654	M16 x 2.00	20mm	12mm	2.54	30.15	12.70	20	39.2	31.8	31.8	12.6	135.00	26,680	50373	10592	50720
50656	M16 x 2.00	22mm	12mm	2.54	30.15	12.70	22	44.3	34.9	41.3	12.5	135.00	26,680	50373	10592	50722

T-SLOT CLAMPS



	Part Number	T-Slot Size	Number of Clamps Per Pack	Holding Force (Lbs)		Part Number	T-Slot Size	Number of Clamps Per Pack	Holding Force (N)
INCH	10420	3/8	2	800	METRIC	50422	8mm	2	3,558
	10421	7/16	2	800		50424	10mm	2	3,558
	10422	1/2	2	2,000		50426	12mm	2	3,355
	10423	9/16	2	2,000		50428	14mm	2	8,895
	10424	5/8	2	3,000		50430	16mm	2	13,340
	10426	11/16	2	3,000		50432	18mm	2	13,340
						50434	20mm	2	26,680
						50436	22mm	2	26,680

Hex key not included.

ADVANT-EDGE CLAMPS

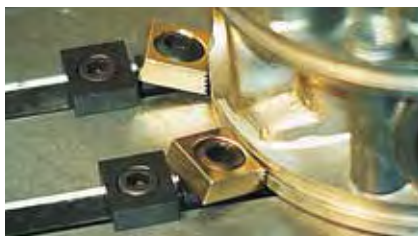

The MITEE-BITE Advant-Edge Clamp provides additional clamping force and improved table grip.

- ▶ Tilted clamping element creates a positive downward force and 4,000 lbs. holding force
- ▶ Hardened clamping element has both a smooth surface for machined workpieces and a serrated clamping surface for rougher work
- ▶ Improved locking mechanism secures clamp to machine table
- ▶ Packaged individually (52224) or as kit of two (52424)

Part Number	Cam Screw	T-Slot Size	B	C	D	E	F	G	H	I	Max. Torque/Holding Force (Ft Lb/Lbs)	Replacement Square Washer
INCH												
52224	50372	5/8	5/16	.100	1.00	.375	.610	1.12	1.89	1.1	65/4,000	51016
METRIC DIMENSIONS												
		16	8	2	25.4	9.5	16	28.5	48	28	88.00/17800	

Torque mounting bolt to 70 Ft/Lbs (150N.m.).

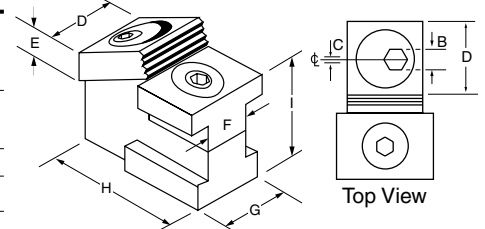

Uniforce® Clamps

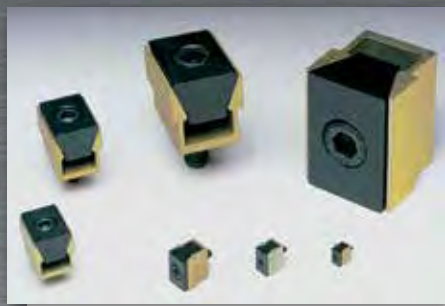

The compact, economical MITEE-BITE Uniforce® Clamp enables you to fixture more parts on the machine table. The specially designed steel wedge spreads the clamping force uniformly on both sides of the 7075-T6 aluminum channel and is one of the best solutions for high density applications.

- ▶ Increases production
- ▶ Minimizes tool changes
- ▶ Holds two parts with equilateral clamping action
- ▶ Ideal for clamping flat or round workpieces
- ▶ Reduces wasted space
- ▶ See Locating Rails on page 40
- ▶ Easily mated to hydraulic pull cylinders
- ▶ Ideal for pallet changers

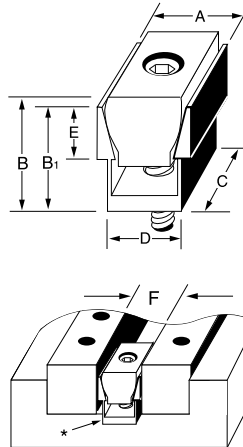

Part Number	Model	A	B	B1	C	D*	E	F†	Thread Size	Maximum Spread	Max. Torque (Ft/Lbs)	Holding Force (Lbs)	Number of Clamps Per Pack	Key Size	-Replacement- Channel	Steel Wedge
INCH																
60250	250	.240	.27	.250	.320	.210	.140	.250	2 - 56	.260	.5	200	6	5/64	60205	60305
60375	375	.360	.38	.375	.470	.310	.185	.375	4 - 40	.390	1.1	310	6	3/32	60207	60307
60500	500	.485	.58	.500	.625	.410	.220	.500	8 - 32	.530	2.5	500	8	9/64	60210	60310
60750	750	.735	.77	.750	.940	.635	.375	.750	1/4 - 20	.785	10.0	1,500	6	3/16	60220	60320
61000	1000	.980	1.02	1.000	1.250	.820	.500	1.000	5/16-18	1.050	19.0	2,500	4	1/4	60230	60330
61500	1500	1.470	1.52	1.500	1.875	1.215	.750	1.500	1/2 - 13	1.560	28.3	3,500	2	3/8	60240	60340
62000	2000	1.960	2.03	2.000	2.500	1.625	1.000	2.000	5/8 - 11	2.080	55.0	6,000	2	1/2	60245	60350
											(N.m.)	(N.)				
METRIC																
80250	250	6.1	6.9	6.40	8.1	5.3	3.6	6.4	M2	6.7	0.70	880	6	1.5	60205	60305
80375	375	9.1	9.7	9.50	11.9	7.9	4.7	9.5	M2.5	10.0	1.50	1,350	6	2	60207	60307
80500	500	12.3	14.5	12.70	15.9	10.4	5.6	12.7	M4	13.2	3.40	2,225	8	3	60210	60310
80750	750	18.6	19.0	19.05	23.8	16.1	9.5	19.0	M6	20.3	13.50	6,675	6	5	60220	60320
81000	1000	24.8	25.9	25.40	31.7	20.8	12.7	25.4	M8	26.9	25.00	11,125	4	6	60230	60330
81500	1500	37.3	38.6	38.10	47.6	30.8	19.0	38.1	M12	39.9	38.40	15,575	2	10	60240	60340
82000	2000	49.7	51.5	50.80	63.5	41.2	25.4	50.8	M16	53.0	74.60	26,700	2	14	60245	60350

D* - A milled slot wider than D dimension will insure clamp remains in line with workpiece. Clamp sides should not come in contact with slot walls during expansion.
 F† - The distance needed between workpieces for clamp clearance. Drill and tap mounting hole on the center of F dimension.

Long Length Uniforce® Channel & Steel Wedge



This material is available in 20" (508mm) lengths so clamps can be fabricated in different lengths to suit any requirement. Channel and steel wedge are not drilled or plated.

Part Number	Model
62010	250 Channel
63010	250 Steel Wedge
62020	375 Channel
63020	375 Steel Wedge
62120	500 Channel
63120	500 Steel Wedge
62220	750 Channel
63220	750 Steel Wedge

Part Number	Model
62320	1000 Channel
63320	1000 Steel Wedge
62420	1500 Channel
63420	1500 Steel Wedge
62520	2000 Channel
63520	2000 Steel Wedge

Machinable Uniforce® Clamps



The compact Mitee-Bite Uniforce® clamp is available with extra material on the clamping jaws so it can be machined to conform to the shape of your workpiece - enabling you to fixture unusual applications easily. The specially designed steel wedge spreads the clamping force uniformly on both sides of the 7075-T6 aluminum channel.

The locking plate properly expands the clamp, while making it rigid for machining. Machine to a slip fit of workpiece. Remove locking plate before clamping workpiece.

NOTE: When clamp is used to hold flat stock, use locking plate to machine faces parallel.

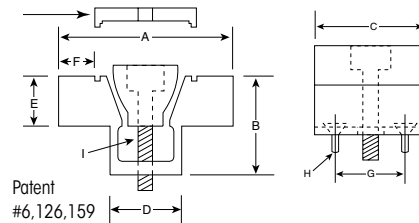

Patent #6,126,159

--Replacement-- Locking Plates	
Model	Part No.
500	60143
750	60145
1000	60155
1500	60165
2000	60185

Model	Part No. with Locking Plate	Part No. Without Locking Plate	A*	B	C	D	E	F†	G	H**	I	Max. Torque (Ft/Lbs)	Holding Force (Lbs)	--Replacement-- Channel	Steel Wedge
INCH															
500	60050	60055	1.125	.50	.62	.420	.25	.18	.400	2-56	8-32	2.5	500	60140	60310
750	60075	60080	1.500	.75	.94	.632	.37	.26	.625	6-32	1/4-20	10.0	1,500	60125	60320
1000	60100	60105	2.000	1.00	1.25	.820	.50	.39	.812	6-32	5/16-18	19.0	2,500	60135	60330
1500	60150	60153	3.000	1.50	1.87	1.215	.75	.62	1.200	10-32	1/2-13	28.3	3,500	60160	60340
2000	60200	60203	4.000	2.00	2.50	1.625	1.00	.80	1.625	1/4-20	5/8-11	55.0	6,000	60180	60350
METRIC															
500	80050	80055	28.6	12.7	15.7	10.67	6.3	4.6	10.16	M2	M4	3.40	2,225	60140	60310
750	80075	80080	38.1	19.1	23.9	16.05	9.4	6.6	15.87	M4	M6	13.50	6,675	60125	60320
1000	80100	80105	50.8	25.4	31.8	20.83	12.7	9.9	20.62	M4	M8	25.00	11,125	60135	60330
1500	80150	80155	76.2	38.1	47.5	30.86	19.1	15.7	30.48	M5	M12	38.40	15,575	60160	60340
2000	80200	80205	101.6	50.8	63.5	41.28	25.4	20.3	41.28	M6	M16	74.60	26,700	60180	60350

A* - The distance needed between workpieces for clamp clearance, drill and tap mounting holes on the center of "A" dimension.

F† - The amount of machinable stock on jaws.

H** - Mounting screws included.

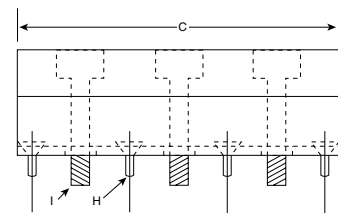

LONG LENGTH MACHINABLE UNIFORCE® CLAMPS

Locking plate is required to machine channel without vibration. (See chart above)



This material is available in 7 1/2" (190mm) lengths. Custom clamps can be fabricated in different lengths to fit specific requirements. Channel and steel wedge are not drilled or plated.

Part Number	Model	A*	B	C	D	E	F†	H	I	Max. Torque (Ft/Lbs)	Holding Force (Lbs)
INCH											
60051	500 Channel	1.125	.50	7.50	.420	.25	.18	2-56	8-32	2.5	500
60052	500 Steel Wedge			7.50							
60071	750 Channel	1.500	.75	7.50	.632	.37	.26	6-32	1/4-20	10.8	1,500
60072	750 Steel Wedge			7.50							
60101	1000 Channel	2.000	1.00	7.50	.820	.50	.39	6-32	5/16-18	10.4	2,000
60102	1000 Steel Wedge			7.50							
60151	1500 Channel	3.000	1.50	7.50	1.215	.75	.62	10-32	1/2-13	28.3	3,500
60152	1500 Steel Wedge			7.50							
METRIC											
80051	500 Channel	28.6	12.7	190mm	10.67	6.3	4.6	M2	M4	3.40	2225
80071	750 Channel	38.1	19.1	190mm	16.05	9.4	6.6	M4	M6	14.30	6675
80101	1000 Channel	50.8	25.4	190mm	20.83	12.7	9.9	M4	M8	14.50	8900
80151	1500 Channel	76.2	38.1	190mm	30.86	19.1	15.7	M5	M12	38.40	15575

A* - The distance needed between workpieces for clamp clearance, drill and tap mounting holes on the center of "A" dimension.

F† - The amount of machinable stock on jaws.

(3) Drive Screws and (4) Mounting Screws included.

OK-VISE® Clamps

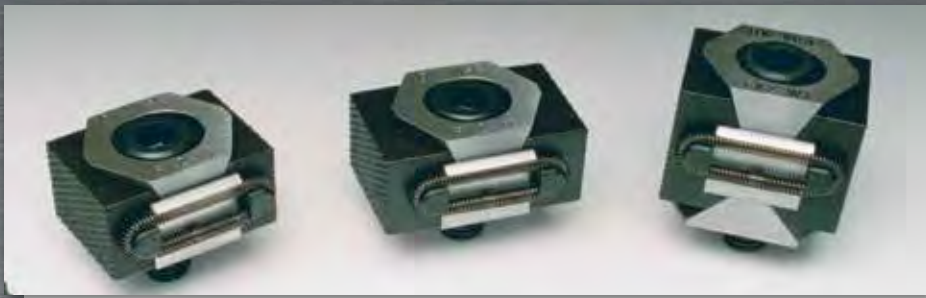

THREE-DIMENSIONAL MACHINING

Due to a low-profile design of OK-VISE® Clamps, it is possible to execute flexible three-directional machining of workpieces with one fastening. This ability to machine a workpiece in three planes means improved accuracy.

PULL DOWN ACTION

The single wedge clamps keep the workpieces steadily in place, not allowing upward or downward movement. The double-wedge clamps generate a pull-down action pressing the workpieces towards the fixture base.

MACHINABLE JAWS

Single-wedge clamps are also available with extended jaws that can be machined to suit the geometry of the workpiece.

SPECIAL MODELS

"B": (Ball on 1 Jaw)

"E": (Balls on each Jaw)

A self adjusting serrated steel ball is helpful when clamping castings and workpieces of irregular shape.

"T": Jaws tapped with M5 threads for socket head screws allowing for quick and easy use of various different additional pieces.

"SS": BK2 is available in high quality stainless steel to meet the demands of EDM applications.

ECONOMY MODEL

"O": Not ground as precise as standard models. Same raw material is being used and the bottom of the jaws are ground for precise locating on the fixture base.

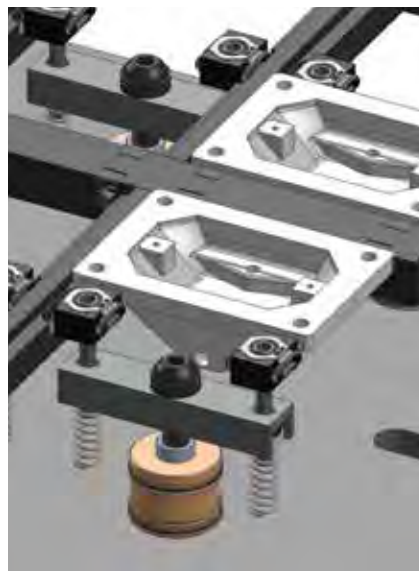

SINGLE-WEDGE OK-VISE® CLAMPS

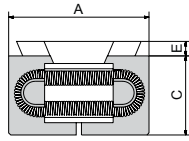
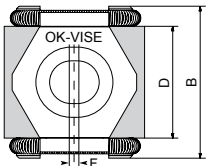

Strong lateral clamping with a single wedge design.

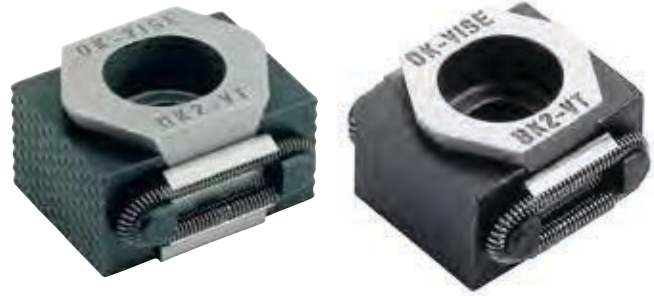

Part Number	Model	Description	A			B	C	D	E	F	Mounting Screw (included)	Max. Torque (Ft/Lbs)	Holding Force of Jaws (Lbs)	Hardness of Jaws HRC
			Min.	Optimum	Max.									
47100	AK2-VT-SO	Smooth Jaw	.79	.90	.98	.86	.43	.59	.16	.060	10-32 x 3/4	7	2,000	48-52
47110	BK2-VT-S	Smooth Jaw	1.06	1.14	1.22	1.14	.59	.83	.10	.060	5/16-18 x 3/4	30	5,500	48-52
47105	BK2-VT-O	Serrated Jaw	1.06	1.14	1.22	1.14	.59	.83	.10	.060	5/16-18 x 3/4	30	3,000	48-52
47103	BK2-VT-SO	Smooth Jaw	1.06	1.14	1.22	1.14	.59	.83	.10	.060	5/16-18 x 3/4	30	3,000	48-52
47115	BK2-VT	Serrated Jaw	1.06	1.14	1.22	1.14	.59	.83	.10	.060	5/16-18 x 3/4	30	5,500	48-52
47113	BK2-VT-SS	Stainless Smooth Jaw	1.06	1.14	1.22	1.14	.59	.83	.10	.060	5/16-18 x 3/4	30	5,500	48-52
47130	DK2-VTI	Serrated Jaw	1.65	1.77	1.93	1.61	.87	1.18	.16	.080	1/2-13 x 1 1/4	110	14,500	48-52
47160	FK2-VT	Serrated Jaw	2.24	2.40	2.57	2.20	1.14	1.65	.20	.145	5/8-11 x 1 1/2	250	24,900	48-52

DOUBLE-WEDGE OK-VISE® CLAMPS

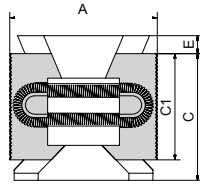
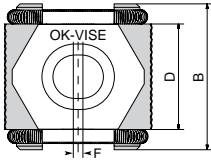

Increased clamping force and the double wedge design pulls the workpiece down.



Part Number	Model	Description	A			B	C	C1	D	E	F	Mounting Screw (included)	Max. Torque (Ft/Lbs)	Holding Force of Jaws (Lbs)	Hardness of Jaws HRC
			Min.	Optimum	Max.										
47150	DK2-WTI	Serrated Jaw	1.65	1.81	1.93	1.61	1.42	1.18	1.18	.20	.080	1/2-13 x 1 1/2	110	20,000	48-52
47180	FK2-WT	Serrated Jaw	2.28	2.40	2.64	2.20	1.97	1.65	1.65	.20	.145	5/8-11 x 2 1/4	250	33,000	48-52

MACHINABLE SINGLE-WEDGE OK-VISE® CLAMPS

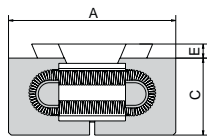
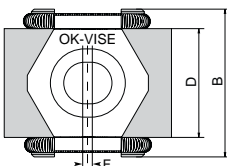

Additional material is added to these machinable jaws.



Part Number	Model	Description	A			B	C	D	E	F	Mounting Screw (included)	Max. Torque (Ft/Lbs)	Holding Force of Jaws (Lbs)	Hardness of Jaws HRC
			Min.	Optimum	Max.									
47120	BK2-VT-S+5	Smooth Jaw	1.30	1.38	1.46	1.14	.59	.83	.10	.060	5/16-18 x 3/4	30	5,000	30-34
47140	DK2-VTI+5	Serrated Jaw	2.05	2.17	2.32	1.61	.87	1.18	.16	.080	1/2-13 x 1 1/4	110	12,000	30-34
47170	FK2-VT+5	Serrated Jaw	2.64	2.76	2.99	2.20	1.14	1.65	.20	.145	5/8-11 x 1 1/2	250	22,000	30-34

All clamps available with smooth jaws. Lead time may apply.

OK-VISE® Clamps

SPECIAL MODEL OK-VISE® CLAMPS

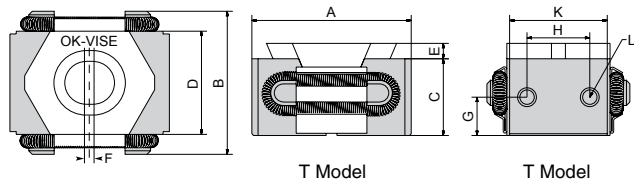

Part Number	Model	Description	A			B	C	D	E	G	H	K	L	Mounting Screw (Included)	Max. Torque (Ft/Lbs)	Holding Force of Jaws (Lbs)	Hardness of Jaws HRC
			Min.	Opt.	Max.												
47112	BK2-VT-T	Tapped Jaws	1.30	1.38	1.46	1.14	0.59	0.83	0.10	0.30	0.47	.83	M5	5/16-18 X 3/4 SHCS	30	5,000	30-34
47145	DK2-VT-T	Tapped Jaws	1.81	1.93	2.09	1.61	0.87	1.18	0.16	0.43	0.71	1.10	M5	1/2-13 X 1 1/4 SHCS	110	12,000	30-34
47175	FK2-VT-T	Tapped Jaws	2.40	2.56	2.76	2.20	1.14	1.65	0.19	0.57	1.02	1.57	M5	5/8-11 X 1 1/2 SHCS	250	22,000	30-34

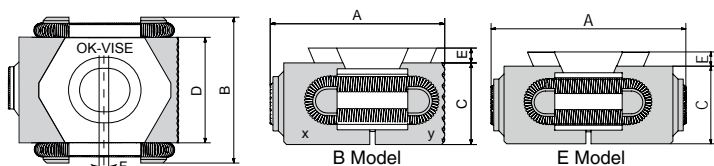

Part Number	Model	Description	A			B	C	D	E	G	H	K	L	Mounting Screw (Included)	Max. Torque (Ft/Lbs)	Holding Force of Jaws (Lbs)	Hardness of Jaws HRC
			Min.	Opt.	Max.												
47185	BK2-VT-B	Serrated Ball on Jaw	1.30	1.38	1.46	1.14	.59	.83	.10	-	-	-	-	5/16-18 x 3/4	30	5,500	48-52
47190	DK2-VT-B	Serrated Ball on Jaw	2.04	2.16	2.32	1.61	.87	1.18	.16	-	-	-	-	1/2-13 x 1 1/4	110	12,000	48-52
47187	BK2-VT-E	Serrated Ball on each Jaw	1.54	1.61	1.69	1.14	0.59	0.83	0.10	-	-	-	-	5/16-18 X 3/4 SHCS	30	5,000	N/A
47186	DK2-VT-E	Serrated Ball on each Jaw	2.44	2.56	2.72	1.61	0.86	1.18	0.15	-	-	-	-	1/2-13 X 1 1/4 SHCS	110	12,000	N/A

OK-VISE® REPLACEMENT PARTS

Model	Spring	Side Plate
AK Series	47095*	47123
BK Series	47125	47127
DK Series	47135	47137
FK Series	47161	47162

*Supplied with O-ring

NEW



OK-VISE® MULTI-RAIL SYSTEM

The Multi-Rail System is a versatile fixturing system perfect for all machining centers. The addition of the new Speed Stop eliminates

the need for the standard Stop (Part No. 47200) to be placed behind clamp. The user can quickly adjust the location of the clamp allowing for different sized parts to be loaded and unloaded faster and more efficiently.

- ▶ All sides of a work piece can be machined with two setups
- ▶ Multiple work pieces can be clamped on the same area
- ▶ The work piece is always safely fixtured
- ▶ Oversized work pieces can also be fastened
- ▶ Over 14,000 lbs. of pressure. Perfect for high speed machining

Speed Stop
Part No.
47205



DK2-VT
Clamp
Part No.
47131



Multi-Rail
Part No.
47220/47260

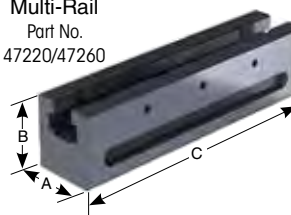

Stop
Part No.
47200

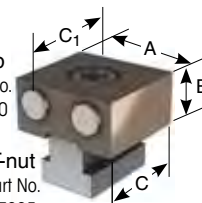

T-nut
Part No.
47225

Part No.	Description	A	B	C	C ₁
47220	Multi-Rail RM200	44mm	50mm	200mm	
47260	Multi-Rail RM600	44mm	50mm	600mm	
47200	Stop Combo Smooth/Serrated	44mm	22mm	40mm	42mm
47225	Multi-Rail Custom M12 T-nut				
47131	DK2-VT Clamp includes M12x25mm Screw				
47205	Speed Stop				

Machinable Pitbull® Clamps

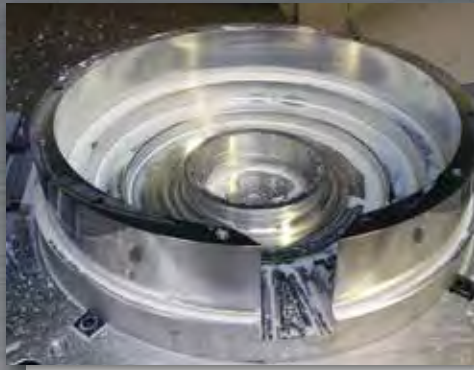

The popular Pitbull® Fixture Clamp is now available in a machinable version. The clamp has positive down force and a very low gripping profile, reducing material cost and number of operations.

The Machinable Pitbull® Clamp is made of A2 tool steel and heat treated to about 43RC for long life, yet still machinable. There is additional material on the clamping face to allow for machining a radius. It is available in two sizes with 6,000 and 12,000 lbs. (26000 and 50000 N) of holding force. A dowel pin is included in each package to locate clamp while machining radius.

Tighten clamp on dowel pin for proper location for machining clamp. Remove pin and install o-ring to clamp workpiece.

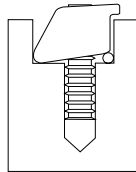

Maximum recommended stock removal from centerline of clamp:
 26077 = .060 26088 = .180
 (56077 = 1.5mm) (56088 = 4.5mm)

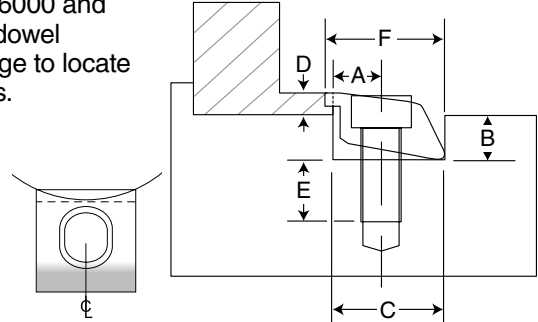

Part Number	Description	A	B	C	D*	E	F	Slot Width	Screw Size	Max. Torque	Total Holding Force	Total Throw	Dowel Pin	Clamps Per Package
INCH 26077	Tool Steel, Machinable	.400	.450	1.00	.250	.710	1.075	1.00	3/8-16	30.0 (Ft/Lbs)	6,000 (Lbs)	.050	1/8	4
26088	Tool Steel, Machinable	.600	.640	1.50	.375	.770	1.70	1.50	1/2-13	108.3 (Ft/Lbs)	12,000 (Lbs)	.075	1/4	2
METRIC 56077	Tool Steel, Machinable	10.16	11.43	25.4	6.35	18.0	26.9	25.4	M10	40.6 (N.m.)	26,000 (N.)	1.27	3.18	4
56088	Tool Steel, Machinable	15.24	16.26	38.1	9.52	19.6	42.6	38.1	M12	145.0 (N.m.)	50,000 (N.)	1.90	6.35	2

D* - Minimum clamping height

Modular Pitbull® Clamps



The Pitbull® Fixture Clamp is very well known for its low profile and positive down force. It is now available as a modular clamp in two styles.

The slotted Modular Pitbull® Clamp with a step offers increased versatility through its unique riser design. This clamp supports the workpiece off the machine table for through milling and drilling. The hardened and ground clamps are designed for use on work cubes, as well as machined tables with tapped holes or T-slot configurations.

The compact Modular Pitbull® Clamp is ideal for clamping workpieces in series by using the back surface of a clamp to locate the next workpiece. The back of the clamp is ground square to the bottom for precise location of parts. The height of the clamp can be adjusted by the depth of the milled slot used to locate the clamp.

Both versions are produced in two sizes with holding forces of 3,600 and 6,000 lbs (16000 and 26000 N).

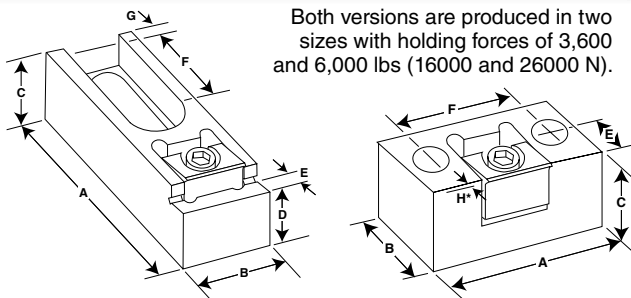

Part Number	Blunt Edge	Description	A	B	C	D		E	F	G	H*	Max. Torque (Ft/Lbs)	Holding Force (Lbs)	Mounting Screw	Slot
						+.0000	-.0005								
INCH 26220	26225	Medium/Compact	2.25	1.23	.98	NA	.62	1.50	-	.024	14.5	3,600	5/16	-	
26230	26235	Large/Compact	2.70	1.48	1.24	NA	.74	1.86	-	.050	30.0	6,000	3/8	-	
26240	26245	Medium/Slotted	4.08	1.25	.99	.7300	.36	1.70	.50	.024	14.5	3,600	1/2	Closed	
26250	26255	Large/Slotted	4.20	1.50	1.61	1.3780	.36	1.52	.43	.050	30.0	6,000	5/8	Closed	
												(N.m.)	(N.)		
METRIC 56220	56225	Medium/Compact	57.1	31.242	25.1	NA	15.7	38.1	-	.61	22.5	16000	M8	-	
56230	56235	Large/Compact	68.6	37.592	31.5	NA	18.8	47.0	-	1.27	40.6	26000	M10	-	
56240	56245	Medium/Slotted	103.6	31.700	25.1	18.542	9.1	43.2	12.7	.61	22.5	16000	M12	Closed	
56250	56255	Large/Slotted	107.0	38.100	40.9	35.000	9.1	38.6	10.9	1.27	40.6	26000	M16	Closed	

H* - Clamp travel

PATENT NO. 6435496

Pitbull® Clamps

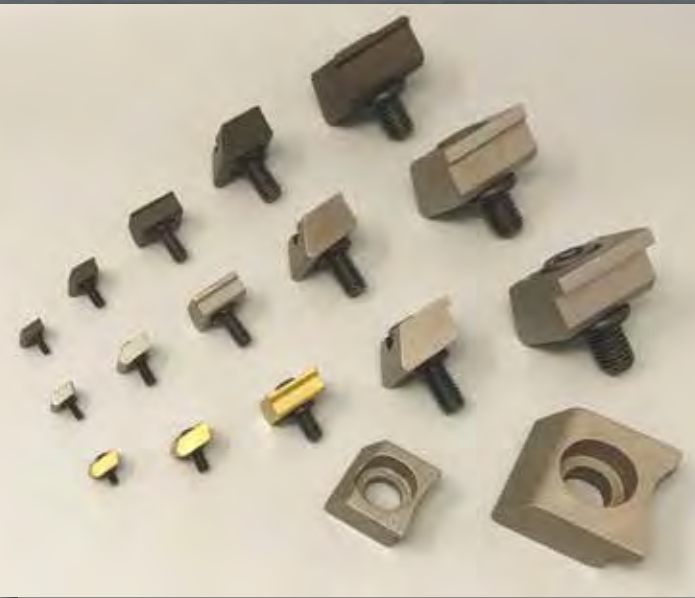

The revolutionary Pitbull® Clamp remains the lowest profile, highest holding force clamp in the industry today. High vertical and horizontal clamping forces are generated, considering the size of the Pitbull® Clamps. It uses a standard cap screw and an oil resistant O-ring. The Pitbull® Clamp is available in 5 sizes and several styles, a tool steel knife edge for aggressive stock removal, a tool steel blunt edge for general purpose, a brass version to help prevent marring the workpiece and a machinable version on page 13.

See Locating Rails, page 40 and TalonGrip™, page 34.

UNIQUE FEATURES:

- ▶ Extremely low bite
- ▶ Positive down force
- ▶ High strength A2 Tool Steel virtually eliminates rip-out
- ▶ Simple, sturdy, high quality design and components
- ▶ Gain maximum tool access to your work
- ▶ Virtually eliminate lost work
- ▶ Great option with hydraulic cylinders



PATENT NO. 6435496

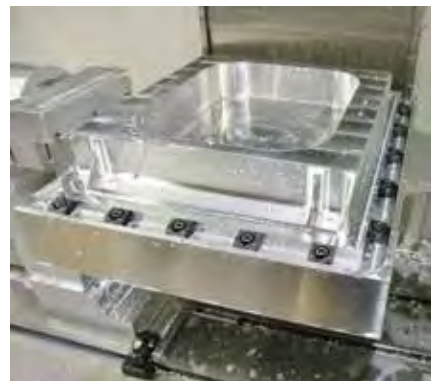
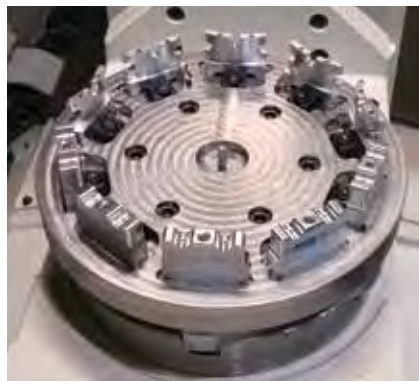
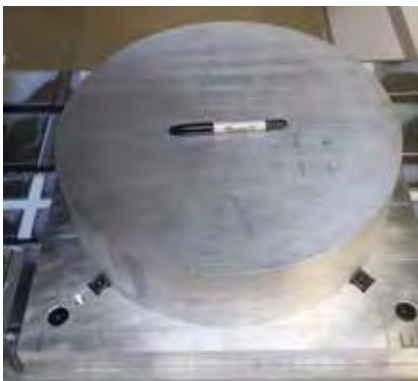
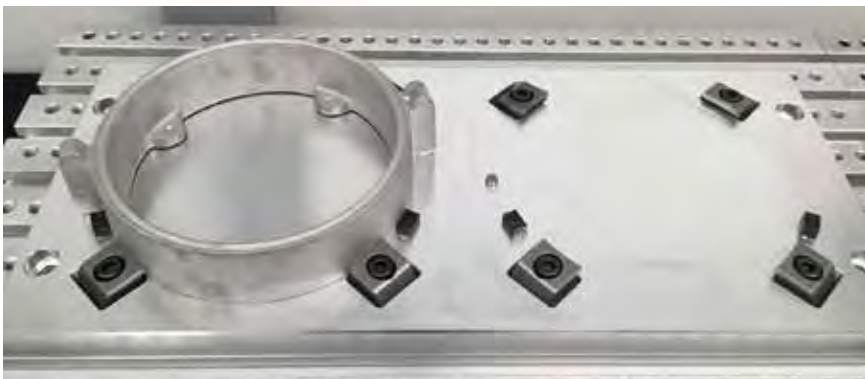

KNIFE EDGE

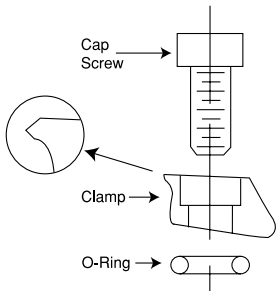

BLUNT EDGE

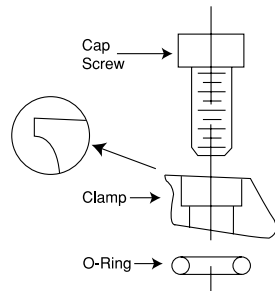

FIXTURE EXAMPLES

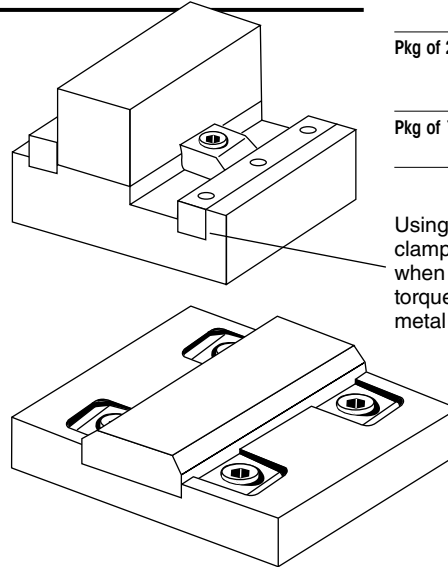

	Replacement O-ring	Screw Size
Pkg of 20	26008	4-40 or M2.5
	26028	8-32 or M4
	26058	1/4-20 or M6
Pkg of 10	26078	3/8-16 or M10
	26083	1/2-13 or M12

Using a steel rail behind clamp in aluminum fixtures when applying maximum torque prevents displacing metal at pivot point.

Both versions of the tool steel clamps generate the same clamping pressure. However, the Knife Edge clamps bite into the material for more aggressive machining, while the Blunt Edge is less likely to mark the workpiece.

The Knife Edge clamp has a black oxide finish. Both the Knife Edge and Blunt Edge clamps are heat treated 43-45Rc.

Creating Fixtures is Easy... Simply:

1. Machine a slot for the Pitbull® Clamp
2. Drill and tap a hole for the cap screw
3. Assemble the clamp as shown in diagram below
4. Position clamp as shown in diagram and loosely screw to fixture
5. Insert workpiece and tighten cap screw

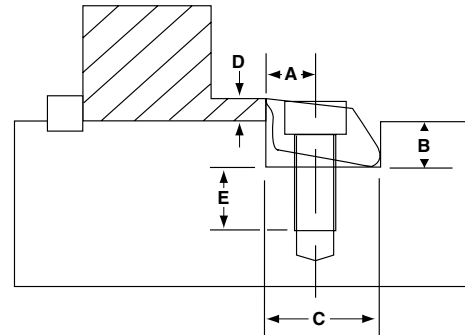

See Locating Rails, page 40 and TalonGrip™, page 34.

	Part Number	Description	Clamp Width			SHCS Screw Size	Max. Torque (Ft/Lbs)	Holding Force (Lbs)	Total Throw	No. Clamps Per Package		
			A	B	C						D*	E
INCH	26000	Tool Steel, Knife Edge	.150	.140	.375	.075	.260	4-40	1.30	650	.0075	8
	26010	Tool Steel, Blunt Edge	.150	.140	.375	.075	.260	4-40	1.30	650	.0075	8
	26015	Brass, Blunt Edge	.150	.140	.375	.075	.220	4-40	.41	200	.0075	8
	26020	Tool Steel, Knife Edge	.200	.187	.500	.100	.390	8-32	3.70	1,500	.0160	8
	26030	Tool Steel, Blunt Edge	.200	.187	.500	.100	.390	8-32	3.70	1,500	.0160	8
	26040	Brass, Blunt Edge	.200	.187	.500	.100	.340	8-32	2.00	400	.0160	8
	26050	Tool Steel, Knife Edge	.300	.280	.750	.150	.570	1/4-20	14.50	3,600	.0240	6
	26060	Tool Steel, Blunt Edge	.300	.280	.750	.150	.570	1/4-20	14.50	3,600	.0240	6
	26065	Brass, Blunt Edge	.300	.280	.750	.150	.440	1/4-20	4.10	950	.0240	6
	26070	Tool Steel, Knife Edge	.400	.450	1.000	.250	.710	3/8-16	30.00	6,000	.0500	4
26075	Tool Steel, Blunt Edge	.400	.450	1.000	.250	.710	3/8-16	30.00	6,000	.0500	4	
26080	Tool Steel, Knife Edge	.600	.640	1.500	.375	.770	1/2-13	108.30	12,000	.0750	2	
26085	Tool Steel, Blunt Edge	.600	.640	1.500	.375	.770	1/2-13	108.30	12,000	.0750	2	
							(N.m.)	(N.)				
METRIC	56000	Tool Steel, Knife Edge	3.81	3.55	9.52	1.90	6.60	M2.5	1.8	2800	.190	8
	56010	Tool Steel, Blunt Edge	3.81	3.55	9.52	1.90	6.60	M2.5	1.8	2800	.190	8
	56015	Brass, Blunt Edge	3.81	3.55	9.52	1.90	5.59	M2.5	.56	875	.190	8
	56020	Tool Steel, Knife Edge	5.08	4.75	12.70	2.54	9.90	M4	5.6	6600	.406	8
	56030	Tool Steel, Blunt Edge	5.08	4.75	12.70	2.54	9.90	M4	5.6	6600	.406	8
	56040	Brass, Blunt Edge	5.08	4.75	12.70	2.54	8.64	M4	2.8	1750	.406	8
	56050	Tool Steel, Knife Edge	7.62	7.11	19.05	3.81	14.48	M6	22.5	16000	.610	6
	56060	Tool Steel, Blunt Edge	7.62	7.11	19.05	3.81	14.48	M6	22.5	16000	.610	6
	56065	Brass, Blunt Edge	7.62	7.11	19.05	3.81	11.18	M6	5.6	4200	.610	6
	56070	Tool Steel, Knife Edge	10.16	11.43	25.40	6.35	18.03	M10	40.6	26000	1.270	4
	56075	Tool Steel, Blunt Edge	10.16	11.43	25.40	6.35	18.03	M10	40.6	26000	1.270	4
	56080	Tool Steel, Knife Edge	15.24	16.26	38.10	9.52	19.56	M12	145.0	50000	1.900	2
	56085	Tool Steel, Blunt Edge	15.24	16.26	38.10	9.52	19.56	M12	145.0	50000	1.900	2

D* - Minimum clamp height

*If gripping below recommended height, ensure clamp does not contact slot wall under load.

Modular In-Line Clamping System



Mitee-Bite announces the addition of our popular fixture clamps in a modular system. Clamps, grips and stops, designed to be fully adjustable while mounted on T-Slot tables and grid plates. This system is designed around our Pitbull® Clamp which remains the strongest, lowest profile fixture clamp in the industry. Producing over 6,000 pounds of force. Available with Knife-Edge, Blunt-Edge or Machinable faces to suit your applications, all producing positive downforce. Low-profile stops and grippers incorporated into design for less tooling interference and savings on

material cost. These modular clamps and stops are ground to the same height as our Large Modular Pitbull® Clamp (page 13) providing even greater versatility.



- ▶ Stops with Talongrip™ or VersaGrip™ to hold both rectangular and irregular/round shapes
- ▶ Mount with your existing T-nut directly to your work table, or mount to grid plate using our Tungsten Carbide faced high grip T-Nuts, 16" Long T-Nut Rail, or fasten directly to table using socket head cap screw.
- ▶ Height of gripper can be adjusted by depth of slot or bore.

INLINE STOP WITH VERSAGRIP™

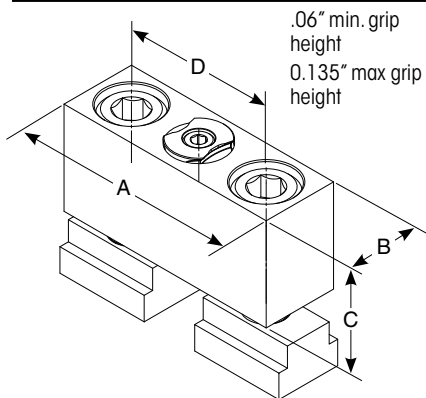

INLINE STOP WITH TALONGRIP™

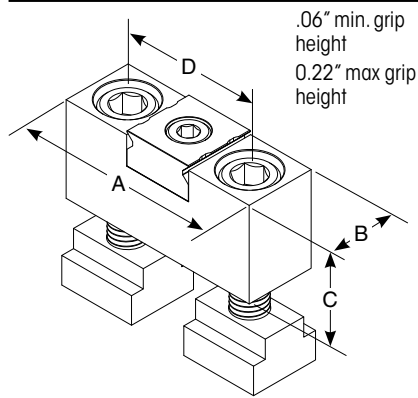

INLINE CLAMP WITH PITBULL® CLAMP

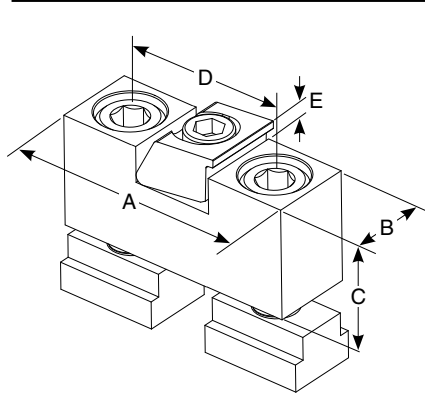

Part No.	Description	A	B	C	D	E
41125	Inline Stop with Versagrip™	76.2mm (3.00")	25.4mm (1.00")	35.0mm (1.378")	50mm (1.97")	n/a
41335	Inline Stop with Talongrip™	76.2mm (3.00")	25.4mm (1.00")	35.0mm (1.378")	50mm (1.97")	n/a
41225	Inline Clamp with Pitbull KNIFE EDGE	76.2mm (3.00")	25.4mm (1.00")	35.0mm (1.378")	50mm (1.97")	6.4mm (.25")
41226	Inline Clamp with Pitbull BLUNT EDGE	76.2mm (3.00")	25.4mm (1.00")	35.0mm (1.378")	50mm (1.97")	6.4mm (.25")
41227	Inline Clamp with Pitbull MACHINABLE	76.2mm (3.00")	25.4mm (1.00")	35.0mm (1.378")	50mm (1.97")	6.4mm (.25")

NEW HIGH GRIP, MEDIUM GRIT, TUNGSTEN CARBIDE COATED T-NUTS

Includes M12 Mounting Screws

Part No.	Description	T-Slot Size
41014	Carbide coated T-nut set (2/pk)	14mm
41016	Carbide coated T-nut set (2/pk)	16mm
41018	Carbide coated T-nut set (2/pk)	18mm

Replacements

32175	Versagrip™ grips with M5 screw (2/pk)	M5x8mm LHCS
33050	Talongrip™ grips with M5 screw (2/pk)	M5x8mm LHCS
56060	Pitbull® M6 Blunt-Edge (4/pk)	M6x16mm SHCS
56070	Pitbull® M6 Knife-Edge (4/pk)	M6x16mm SHCS
56077	Pitbull® M6 Machinable (4/pk)	M6x16mm SHCS



Multi-Fixture Clamps and Stops

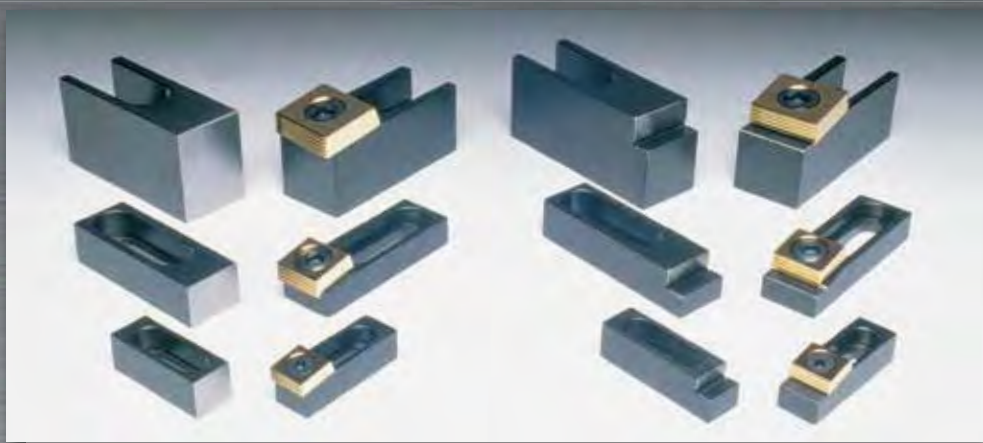

The Multi-Fixture Clamps, with a step, offer increased versatility through their unique riser clamp design. These clamps support the workpiece off the machine table for through milling and drilling.

The Multi-Fixture Clamps, without a step, grip the workpiece at a higher point for more clamping strength and better stability.

The hardened and ground clamps offer quick cam action clamping and are designed for use on work cubes and machine tables with tapped holes or T-slot configurations.

They adjust to unusually shaped parts because the cam action allows the clamping element to always make maximum contact with the workpiece for greater holding force. The tilted clamping element provides positive down force for more accurate machining.

APPLICATIONS WITHOUT STEPS



APPLICATIONS WITH STEPS



WITH STEPS

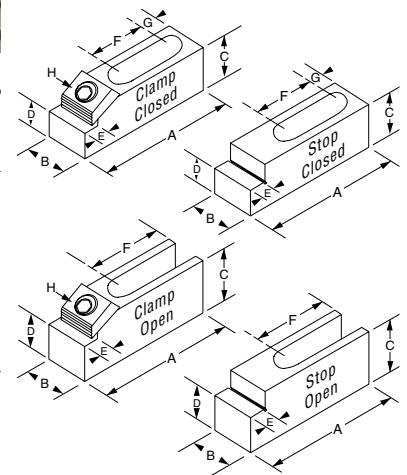

WITHOUT STEPS

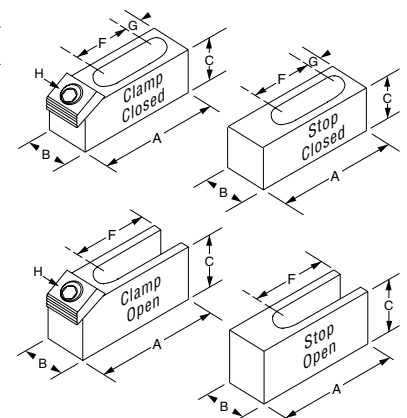

Part Number	Item	A	B	C	D ^{+0.0000} _{-0.0005}	E	F	G	Cam Screw H	Max. Torque (Ft/Lbs)	Holding Force (Lbs)	Mtg. Screw (not incl)	Replacement Square Slot	Washer
INCH														
WITH STEPS														
23140	Clamp	2.50	.75	.62	.4600	.31	.83	.53	10370	8.3	2,000	5/16	Closed	21006
23180	Stop	2.50	.75	.75	.4600	.31	1.11	.53	NA	NA	NA	5/16	Closed	
23150	Clamp	3.75	1.12	.62	.4800	.37	1.68	.50	10372	65.0	4,000	1/2	Closed	21016
23200	Stop	3.75	1.12	.87	.4800	.37	1.68	.50	NA	NA	NA	1/2	Closed	
53170	Clamp	4.21	1.50	1.62	1.3780	.37	1.82	NA	50373	100.0	6,000	5/8	Open	21026
23240	Stop	4.21	1.50	2.00	1.3780	.37	1.82	NA	NA	NA	NA	5/8	Open	
WITHOUT STEPS														
23145	Clamp	2.16	.75	.62	NA	NA	.83	.53	10370	8.3	2,000	5/16	Closed	21006
23148	Stop	2.20	.75	.75	NA	NA	1.11	.53	NA	NA	NA	5/16	Closed	
23155	Clamp	3.37	1.12	.62	NA	NA	1.68	.50	10372	65.0	4,000	1/2	Closed	21016
23158	Stop	3.30	1.12	.87	NA	NA	1.68	.50	NA	NA	NA	1/2	Closed	
53172	Clamp	3.80	1.50	1.62	NA	NA	1.82	NA	50373	100.0	6,000	5/8	Open	21026
23178	Stop	3.30	1.50	2.00	NA	NA	1.82	NA	NA	NA	NA	5/8	Open	

															D ^{+0.0000} _{-0.013mm}	(N.m.)	(N.)
METRIC																	
WITH STEPS																	
53140	Clamp	63.5	19.1	15.8	11.68	8.0	21.1	13.5	50368	28.00	8900	M8	Closed	21006			
23180	Stop	63.5	19.1	19.1	11.68	8.0	28.2	13.5	NA	28.00	8900	M8	Closed				
53150	Clamp	95.3	28.5	15.8	12.19	9.4	42.7	12.7	50372	88.00	17800	M12	Closed	51016			
23200	Stop	95.3	28.5	22.1	12.19	9.4	42.7	12.7	NA	88.00	17800	M12	Closed				
53170	Clamp	107.0	38.1	41.2	35.00	9.4	46.2	NA	50373	135.00	26700	M16	Open	21026			
23240	Stop	107.0	38.1	50.8	35.00	9.4	46.2	NA	NA	135.00	26700	M16	Open				
WITHOUT STEPS																	
53145	Clamp	54.9	19.1	15.8	NA	NA	21.1	13.5	50368	28.00	8900	M8	Closed	21006			
23148	Stop	55.9	19.1	19.1	NA	NA	28.2	13.5	NA	28.00	8900	M8	Closed				
53155	Clamp	85.6	28.5	15.8	NA	NA	42.7	12.7	50372	88.00	17800	M12	Closed	51016			
23158	Stop	83.5	28.5	22.1	NA	NA	42.7	12.7	NA	88.00	17800	M12	Closed				
53172	Clamp	96.5	38.1	41.2	NA	NA	46.2	NA	50373	135.00	26700	M16	Open	21026			
23178	Stop	83.8	38.1	50.8	NA	NA	46.2	NA	NA	135.00	26700	M16	Open				

Dyna-Force® Clamps



The majority of the Dyna-Force® clamp is below the surface of the fixture which provides excellent clamp support and makes for a very low profile. The clamp jaw slides on an angle for positive downforce.

- ▶ Incredible clamping and hold down power
- ▶ Low profile, compact design
- ▶ 17-4 PH stainless steel
- ▶ Smooth or serrated jaws
- ▶ Clamp comes assembled with alloy steel screw.
- ▶ Stainless steel screws and retaining rings are available for EDM applications.

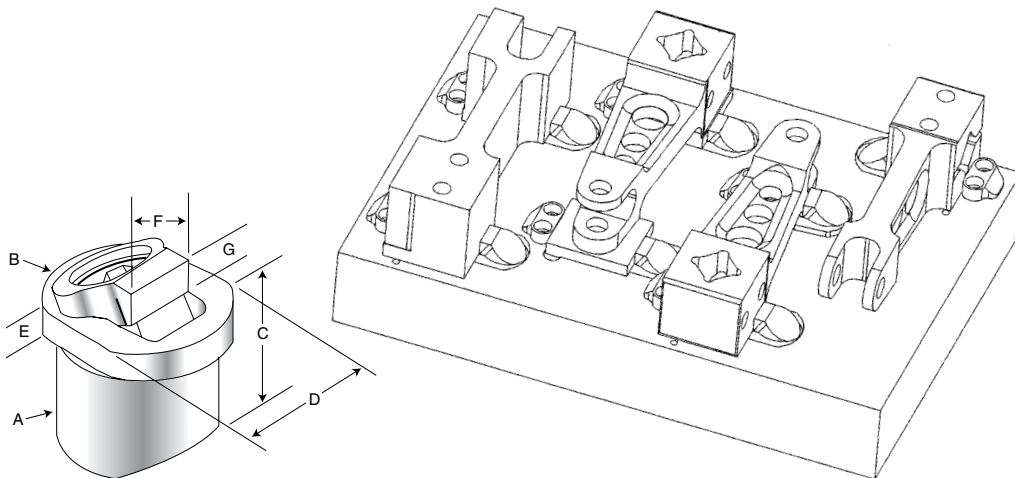

Part Number	Replacement Insert*
28314	28480 (20mm smooth)
28318	28482 (20mm serrated)
28320	28484 (25mm smooth)
28322	28486 (25mm serrated)
28324	28488 (30mm smooth)
28328	28490 (30mm serrated)

*Includes screw and retaining ring

Part Number	Clamp Jaw† & Hardness	A*	B	C	D	E	F	G			Clamp Travel	Drive Screw	Key Size	Maximum Torque	Holding Force
								Min	Optimum	Max					
28314	Smooth 34RC	20.00	24.90	19.00	19.90	4.50	13.50	3.25	5.00	6.75	2.0	M6x12mm SHCS	5mm	7.3 (Ft/Lbs) - 9.9 (N.m)	2,000 (Lbs) - 8896 (N.)
28318	Serrated 44RC														
28320	Smooth 34RC	25.00	29.90	24.00	24.90	5.00	15.00	4.50	6.50	8.25	2.2	M8x16mm SHCS	6mm	17.6 (Ft/Lbs) - 23.9 (N.m)	2,600 (Lbs) - 11565 (N.)
28322	Serrated 44RC														
28324	Smooth 34RC	30.00	37.90	29.00	29.90	7.00	20.00	4.50	7.50	10.75	3.8	M10x18mm SHCS	8mm	35.3 (Ft/Lbs) - 41.9 (N.m)	3,200 (Lbs) - 14234 (N.)
28328	Serrated 44RC														

A* - Body diameter † - Smooth jaw only will have relief cut

1. Bore ϕ of the hole “L” distance from edge of workpiece.
2. Drill and tap “H” to mount clamp in pocket.
3. Machine counter bore if recessing clamp into fixture.
4. Provide a back stop to locate the part.

See Locating Rails on page 40.

NOTES:

1. “N*” - To have rest pad flush with fixture, use the dimension provided. To have the rest pad above the fixture surface, reduce the depth accordingly.
2. For dimensions I and J, use a tolerance of $\pm .1/-0$ mm. For dimension L and O, use $\pm .1/- .1$ mm.

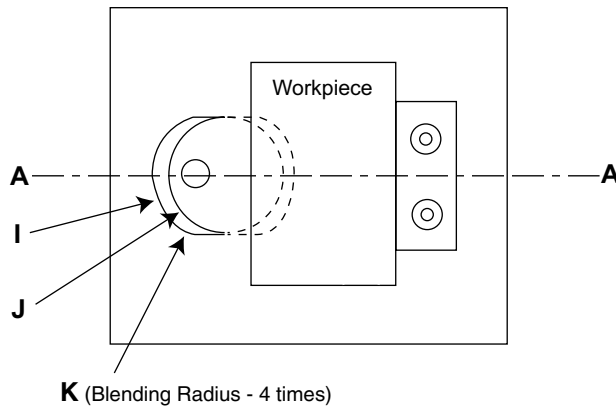
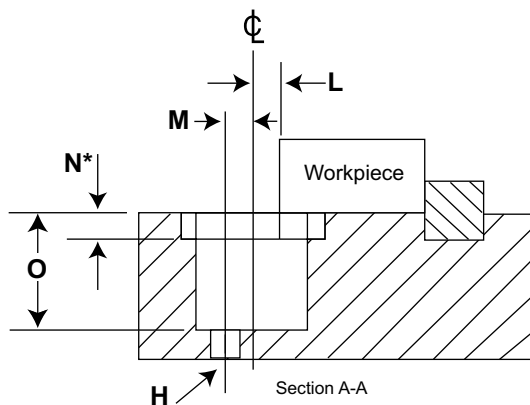

HEIGHT OF JAW IN RELATION TO ϕ OF BORE FROM EDGE OF WORKPIECE.

Height of Jaw G	20mm L	25mm L	30mm L
3.25	5.91		
3.50	5.77		
3.75	5.62		
4.00	5.48		
4.25	5.33		
4.50	5.19	6.81	8.78
4.75	5.05	6.66	8.63
5.00	4.90	6.52	8.49
5.25	4.76	6.37	8.35
5.50	4.61	6.23	8.20
5.75	4.47	6.08	8.06
6.00	4.32	5.94	7.91
6.25	4.18	5.80	7.77
6.50	4.03	5.65	7.62
6.75	3.89	5.51	7.48
7.00		5.36	7.34
7.25		5.22	7.19
7.50		5.07	7.05
7.75		4.93	6.90
8.00		4.78	6.76
8.25		4.64	6.61
8.50			6.47
8.75			6.33
9.00			6.18
9.25			6.04
9.50			5.89
9.75			5.75
10.00			5.60
10.25			5.46
10.50			5.31
10.75			5.17

Example: 20mm clamp when ϕ of bore is 4.90mm from edge of workpiece
 (L - see drawing on left): jaw height is 5.00mm (G - see drawing on page 18).

Part Number	H	I	J	K	L	M	N	O
28314	M5 or 10-24 SHCS	25.00	20.00	6.00	4.90	5.00	4.50	20.00
28318	M5 or 10-24 SHCS	25.00	20.00	6.00	4.90	5.00	4.50	20.00
28320	M6 or 1/4-20 SHCS	30.00	25.00	6.50	5.65	6.00	5.00	25.00
28322	M6 or 1/4-20 SHCS	30.00	25.00	6.50	5.65	6.00	5.00	25.00
28324	M8 or 5/16-18 SHCS	38.00	30.00	8.00	7.05	7.50	7.00	30.00
28328	M8 or 5/16-18 SHCS	38.00	30.00	8.00	7.05	7.50	7.00	30.00

Kopal® Mini Clamps



These low profile cam action clamps and stops have a holding force of 880 lbs. (3900N.) and have fingers that push the workpiece down before clamping, even on castings that have negative draft!

Ground stops are mounted with special screws to ensure high precision locating.

Installation instructions and CAD files available online: MiteeBite.com



CLAMPING KEY

25980 4mm

CAM ACTION CLAMPS

The clamping element rotates around the eccentric insert that provides for clamping in all directions. Clamping range: .047" (1.2mm). Made of spring steel.

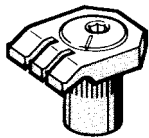
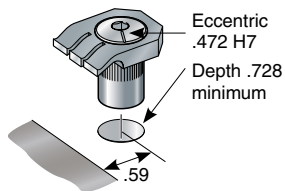

LOW PROFILE CLAMP

Part Number	Clamping Height	Max. Torque
25210	.100 (2.5mm)	6.6 Ft. Lbs. (8.95N.m.)

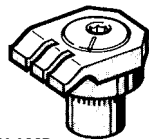

RAISED CLAMP

Part Number	Clamping Height	Max. Torque
25215	.300 (7.5mm)	6.6 Ft. Lbs. (8.95N.m.)

Special mounting screws included

STOPS/LOCATORS

The single stop with only one rigid stop is used for pieces over 1.75" (44.5mm) long. The double stop with 2 rigid stops is used for small size pieces. Both are made of spring steel.

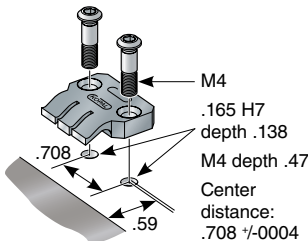

RAISED DOUBLE STOP

Part Number	Jaw Height
25120	.300 (7.5mm)

SINGLE STOP

Part Number	Jaw Height
25105	.100 (2.5mm)

DOUBLE STOP

Part Number	Jaw Height
25110	.100 (2.5mm)

RAISED SINGLE STOP

Part Number	Jaw Height
25115	.300 (7.5mm)

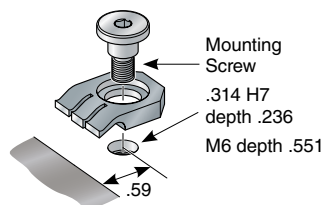

SWIVEL STOP

Part Number	Jaw Height
25125	.100 (7.5mm)

RAISED SWIVEL STOP

Part Number	Jaw Height
25130	.300 (7.5mm)



How to Hold a Workpiece When You Can't Use a Clamp

Mitee-Grip™ is a heat activated wax based compound embedded in precision paper, coated on nylon mesh or in a stick form. This holding media maintains parallelism on precision parts. It is very useful for thin parts, micro machining, optical and quartz components, and jewelry related items. Approximate holding force 40 PSI.



The stick form material can be used in shallow cavities for holding concave and convex pieces. It will also stabilize delicate parts during machining.



The mesh product captures additional wax material in the web and aids in holding irregular shape parts. Typically additional holding force can be attained with this material.

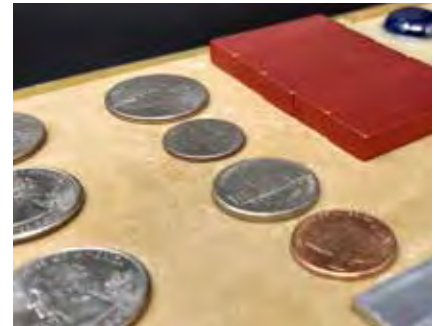

The original paper product is excellent for holding smooth flat parts and maintaining parallelism.

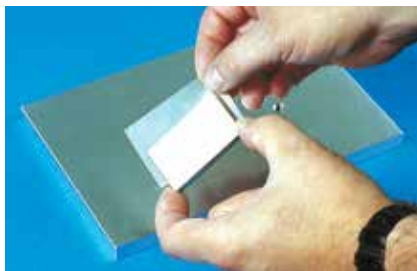

1 Place the Mitee-Grip™ sheet on the subplate leaving a 1/4" (6mm) border on all sides, or melt stick on warm subplate

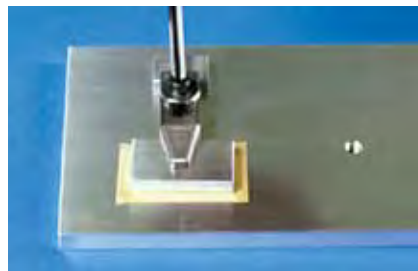

2 In some cases the part should be lightly clamped to prevent movement. NOTE: Over thin workpieces use a top plate for even pressure.

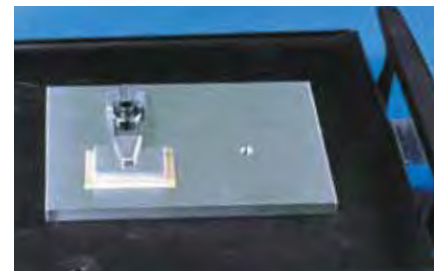

3 225°F (107°C) is application temperature and fully liquid, 186°F (85°C) is solid and becoming liquid. Some customers use an oven and record time and temp once determined by experimentation. A hot plate may also be used at higher temps if monitored. Most parts will "float" when the Mitee-Grip™ has liquefied.

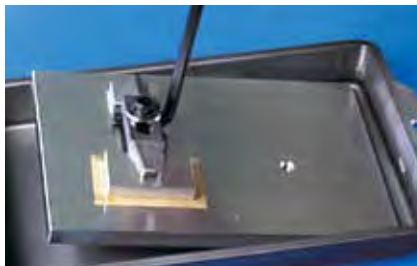

4 Use air or water to cool, being careful to prevent water from going between subplate and workpiece while hot.



5 Part is ready, use coolant while machining. Reheat to remove. We have found an ultrasonic cleaner is best to remove wax residue or simply wipe part while warm using alcohol based cleaner.

Part No.	Desc.	Size (Metric)
10240	Paper Roll	12"x5' (305x1524)
10245	Paper Roll	12"x25' (305x7620)
10250	Mesh Roll	10"x5' (254x1524)
10252	Mesh Roll	10"x25' (254x7620)
10230	Compound	1 Stick
10235	Compound	3 Sticks

ID Xpansion™ Clamp



The ID Xpansion™ clamp is the ideal solution to hold parts on an inside diameter for high density machining on vertical or horizontal machining centers. It can also be used as an expanding mandrel on a lathe.

These machinable clamps are produced in 12L14 steel with black oxide coating in 12 sizes and can hold internal diameters from under 3/16 to almost 10 inches (4.1 to 254mm). #10 manufactured using 7075-T6 aluminum.

The flange diameter of the clamp is held to a close tolerance for precision locating in a machined pocket on work cubes and fixture plates.

The customer machines the mild steel clamp to match the bore of the part ensuring a proper fit. Often times the clamps can be remachined for different size jobs.

The low profile ID Xpansion™ Clamp can hold several parts in one compact area for secondary operations without any clamping interference. They are quickly tightened with a hex key, torque driver or can be mated to hydraulic pull cylinders for automation.

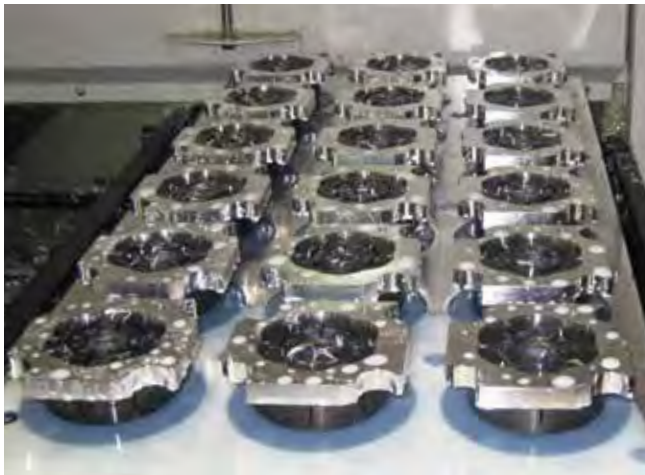

- ▶ Low profile
- ▶ Ideal for secondary operations on lathe parts
- ▶ Easily machined to size on lathe or mill
- ▶ Excellent for palletized setups
- ▶ Allows more parts per workcube or fixture plates
- ▶ Heat-treated and coated screw for long life
- ▶ Clamp body made of mild steel for machinability
- ▶ Tighten with hex key or hydraulic pull cylinders
- ▶ Longer screws available for hydraulic applications

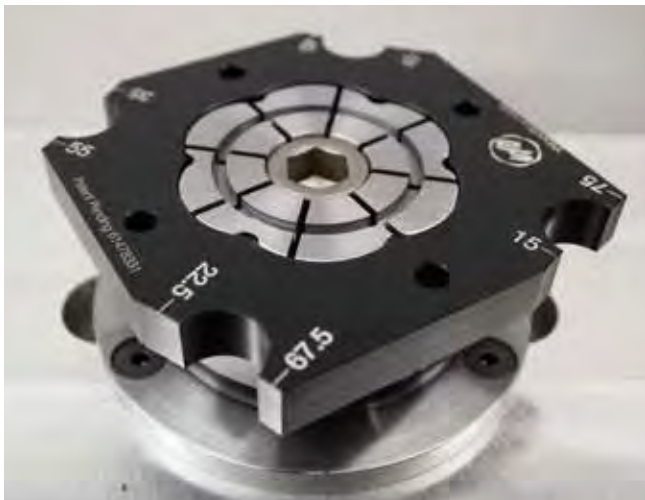

Hard milling

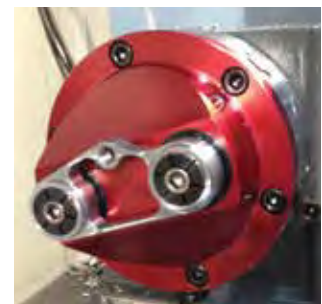

Innovative 4th axis solution

Model #00 - #6 ID Xpansion™ Clamps

- ▶ Expand clamp approximately .002 to .003 (.1mm) over relaxed diameter and machine to fit workpiece bore, either on lathe or mill.
- ▶ If machining the clamp on a lathe use the nut provided, on the back of the clamp, to tighten the tapered screw. This nut is used only while machining the clamp.
- ▶ Machine a pocket in the fixture, for the close tolerance “E” dimension and drill and tap mounting holes per “H” column. Drill and tap a hole from the “I” column in the center of the pocket for the tapered screw.
- ▶ A recessed dowel pin may be installed into the flange for additional rigidity if required.
- ▶ Custom screws available for blind hole applications.
- ▶ Range of expansion .005 to .025 (.13 to .64mm) depending upon size. See MiteeBite.com for individual clamp expansion range.

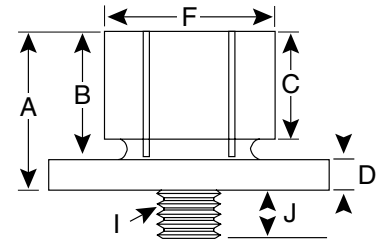
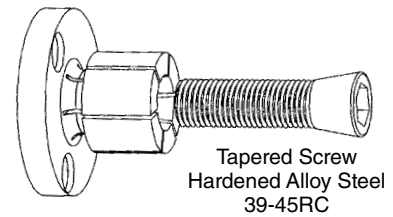

Model #7 - #10 ID Xpansion™ Clamps

- ▶ Locking ring provided to ensure segments remain rigid while machining clamps to size. #10 ID ships with 2 rings.
- ▶ Insert ring(s) and tighten drive screw, machine clamp to bore size. Remove ring(s) to clamp workpiece.
- ▶ Expand mandrel then machine to size.
- ▶ Aggressive material removal is not recommended when machining clamps to size.

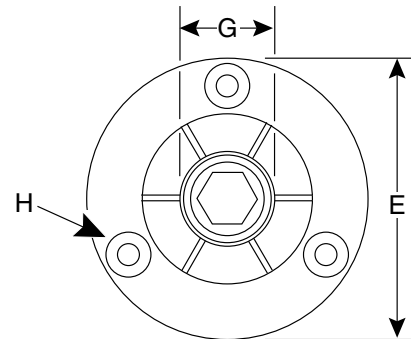

Longer tapered screws are available for each ID size.

	Part No.	Model No.	A	B	C	D	E ^{+0.000 -0.002}	F	G†	H*	I	J	Max. Torque (Ft/Lbs)	Holding Force (Lbs)	Replacement Tapered Screw
INCH	31000	#00	.42	.30	.24	.12	.787	.29	.16	2-56 on .540 BHC	2-56 x 1/2	.16	0.5	250	31001
	31050	#0	.86	.63	.59	.23	1.170	.49	.28	6-32 on .825 BHC	8-32 x 1	.30	3.6	950	31002
	31100	#1	.98	.75	.59	.23	1.240	.56	.48	6-32 on .910 BHC	1/4-20 x 1 1/4	.50	13.3	1,900	31010
	31150	#2	.98	.75	.59	.23	1.476	.79	.53	6-32 on 1.140 BHC	5/16-18 x 1 1/4	.56	27.6	2,500	31020
	31200	#3	1.13	.88	.69	.25	1.968	1.06	.71	8-32 on 1.550 BHC	3/8-16 x 1 1/2	.71	49.3	4,500	31032
	31250	#4	1.25	1.00	.81	.25	2.205	1.39	.90	8-32 on 1.790 BHC	1/2-13 x 1 1/2	.71	120.0	5,900	31042
	31300	#5	1.56	1.25	1.06	.31	2.736	1.65	1.15	10-32 on 2.200 BHC	5/8-11 x 1 3/4	.79	224.0	10,000	31052
	31350	#6	1.56	1.25	1.06	.31	2.972	2.03	1.15	10-32 on 2.515 BHC	5/8-11 x 1 3/4	.79	224.0	10,000	31052
	31400	#7	1.79	1.48	1.27	.31	4.232	3.06	1.15	1/4-20 on 3.646 BHC	5/8-11 x 2	.79	224.0	10,000	31072
	31450	#8	1.79	1.48	1.27	.31	5.232	4.06	1.15	1/4-20 on 4.648 BHC	5/8-11 x 2	.79	224.0	10,000	31072
	31500	#9	1.79	1.48	1.27	.31	5.232	6.89	1.15	1/4-20 on 4.648 BHC	5/8-11 x 2	.79	224.0	10,000	31072
	31550	#10**	1.79	1.48	1.27	.31	6.000	9.85	1.15	1/4-20 on 5.250 BHC	5/8-11 x 2	.79	125.0	6,000	31072

	Part No.	Model No.	A	B	C	D	E ^{+0.000 -0.050}	F	G†	H*	I	J	Max. Torque (N.m.)	Holding Force (N)	Replacement Tapered Screw
METRIC	38000	#00	10.7	7.6	6.1	3.0	20.00	7.4	4.1	M2 on 13.7 BHC	M2x12	4.1	.70	1113	38001
	38050	#0	21.8	16.0	15.0	5.9	29.72	12.4	7.1	M3 on 20.95 BHC	M4x25	7.2	5.00	4228	38002
	38100	#1	24.9	19.0	15.0	5.9	31.50	14.2	12.2	M3 on 23.1 BHC	M6x30	11.2	17.00	8455	38010
	38150	#2	24.9	19.0	15.0	5.9	37.50	20.0	13.5	M3 on 29.0 BHC	M8x30	13.2	34.00	11125	38020
	38200	#3	28.6	22.2	17.5	6.4	50.00	27.0	18.0	M4 on 39.4 BHC	M10x35	16.3	60.00	20025	38032
	38250	#4	31.8	25.4	20.6	6.4	56.00	35.3	23.0	M4 on 45.5 BHC	M12x40	20.3	150.00	26255	38042
	38300	#5	39.6	31.8	27.0	7.9	69.50	42.0	29.3	M5 on 55.9 BHC	M16x45	21.4	280.00	44500	38052
	38350	#6	39.6	31.8	27.0	7.9	75.50	51.5	29.3	M5 on 63.9 BHC	M16x45	21.4	280.00	44500	38052
	38400	#7	45.5	37.6	32.3	7.9	107.50	77.7	29.3	M6 on 92.6 BHC	M16x50	19.3	280.00	44500	38072
	38450	#8	45.5	37.6	32.3	7.9	132.90	103.0	29.3	M6 on 118.06 BHC	M16x50	19.3	280.00	44500	38072
	38500	#9	45.5	37.6	32.3	7.9	132.90	175.0	29.3	M6 on 118.06 BHC	M16x50	19.3	280.00	44500	38072
	38550	#10**	45.5	37.6	32.3	7.9	152.40	250.2	29.3	M6 on 133.35 BHC	M16x50	19.3	170.00	26000	38072

G† - Minimum diameter the "F" dimension can be machined or turned down to.

H* - (3) Mounting Screws included - (4) for model numbers #9 and #10.

**Model #10 Made from 7075-T6 aluminum.

Side-Loc Xpansion Clamp



The Side-Loc Xpansion Clamp is actuated from the side, making it perfect for blind hole applications.

It's produced for both mill and lathe applications. The cam shaft and plunger expands the clamp from the side. Same mounting dimensions as our original ID clamp.



The Side-Loc Xpansion Clamp is actuated by turning a socket head cam shaft on the side, which moves a tapered plunger to expand the clamp. The locking ring provides an accurate preset diameter and rigidity for machining. Maximum torque on locking ring 10 ft. lbs. (13 N.m.). Like our original ID Xpansion™ clamps, the Side-Loc Xpansion Clamp has the dead length feature which is critical for close tolerance dimensions.

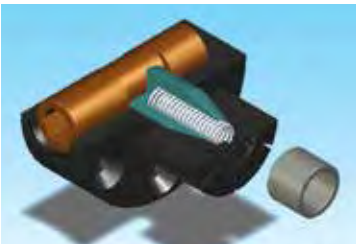

The Side-Loc Xpansion Clamp is designed in two styles: one for milling operations and one for lathe applications. One size is available for each model. The mill Side-Loc Xpansion Clamp can be machined from 1.120 to .710 (28.4 to 18mm) and the lathe version from 2.09 to .710 (53 to 18mm). The lathe version has a 1" (25mm) straight shank.

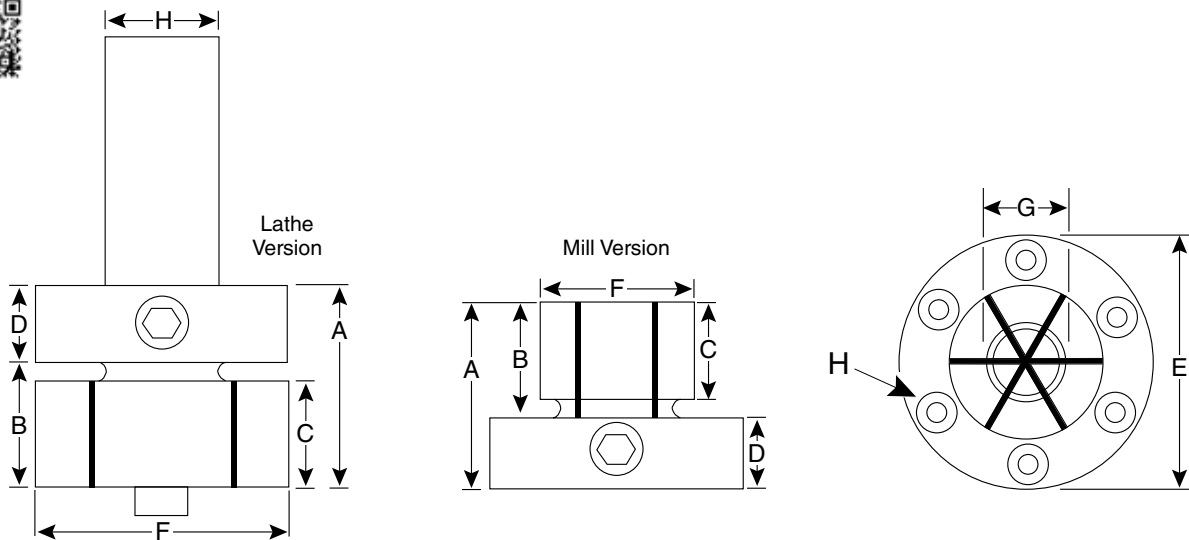

Part Number	Model No.	A	B	C	D	E ^{+0.000 -0.002}	F	G†	H*	Hex Key	Max. Torque (Ft/Lbs)	Holding Force (Lbs)	Replacement			
													Cam Shaft (M12x30MM)	Spring	Ring	
INCH	31210	Mill #3	1.625	.875	.69	.75	1.968	1.12	.71	8-32 on 1.550 BHC	M6	49**	4,000	389001	31207	31202
	31370	Lathe #6	1.750	1.000	.84	.75	NA	2.09	.71	1.0	M6	49**	4,000	389001	31207	31202
						E ^{+0.000 -0.050}					(N.m.)	(N.)				
METRIC	38210	Mill #3	41.3	22.2	17.5	19.0	50.0	28.7	17.8	M4 on 39.4 BHC	M6	66**	20000	389001	31207	31202
	38370	Lathe #6	44.4	25.4	21.3	19.0	N/A	53.3	17.8	25	M6	66**	20000	389001	31207	31202

† - Minimum diameter the "F" dimension can be machined down to. H* - (6) mounting screws included. ** - If high cycles, run max. torque 40 Ft/Lbs or 62 N.m.

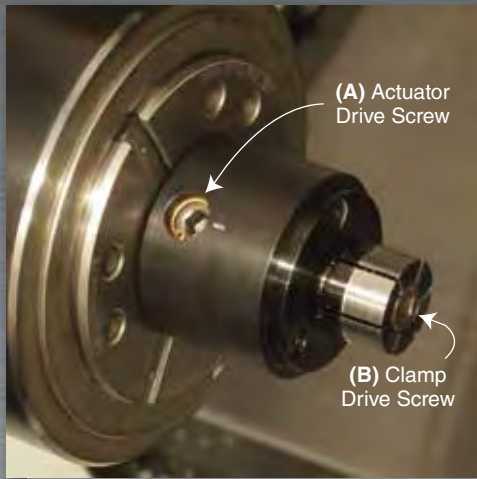

The Actuators are specifically designed for gripping the ID of blind holes but may also be incorporated in many applications that require a straight draw actuated 90 degrees from the drive screw. The Actuators are capable of gripping on bores ranging from .16" (4.1mm) to 1.39" (35.3mm) using our standard ID clamps, Models #00 through #4 (flange on #4 may require modification when mounting to Mill Actuator).

The Mill block can be mounted in several ways including on a fixture plate, for high density workholding applications, or gripped in a vise. The same bolt hole configuration can be used for both the vertical and horizontal planes.

Both styles of Actuators come completely assembled with the heat-treated cylinders tapped for the following clamp drive screws: M2, M4, M6, M8, M10 and M12.

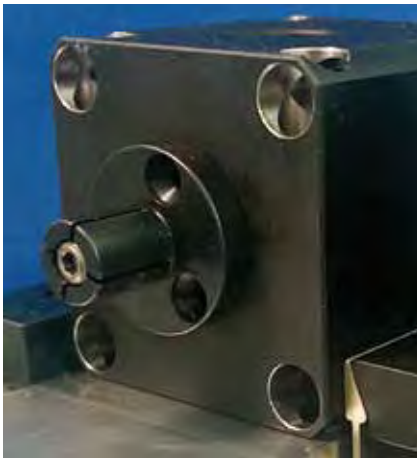

SPECIFICATIONS:

- ▶ Manual Actuators will produce over 4,000 lbs. of pull-force with 45 ft. lbs. of torque. Do not exceed 5 ft/lbs with the M2 or 20 ft/lbs with the M4.
- ▶ Customer will mount clamps onto the Actuator according to clamp instructions. Actuators may be used with clamps other than ID Xpansion™ Clamps.
- ▶ The Mill version has 8 mounting holes with 1.75" (44.45mm) spacing for 1/4-20 (or M6) mounting bolts.
- ▶ The "top" access hole for the clamp drive screw is approximately .315" (8mm) for the M2 through M8 and .484" (12.3mm) for the M10 and M12.
- ▶ Cylinder travel is .040" (1.016mm)
- ▶ Threaded cylinders may be interchanged with our other cylinder sizes by first removing the retaining ring and the actuator drive screw and then tapping out the cylinder. This may require the use of a rubber mallet and punch.
- ▶ Threaded cylinders are heat treated to 54 RC, and have a diameter of 5/8" (15.875mm).
- ▶ Both the Mill and Lathe versions are made of 12L14 with a black oxide finish.

MILL VERSION

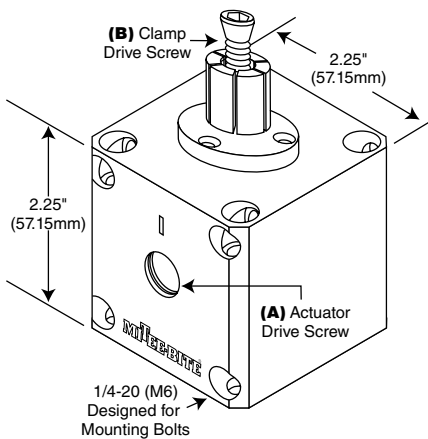

LATHE VERSION

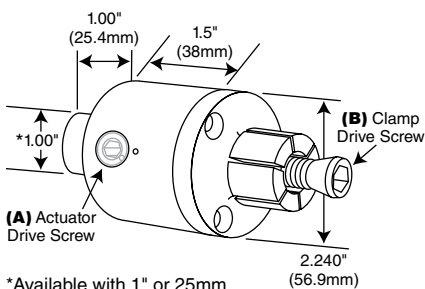

*Available with 1" or 25mm shaft diameter - see chart to right

OPERATION AND USE:

- ▶ Align Indicator mark on actuating screw (A) (apex of cam) with the alignment mark on actuator housing.
- ▶ Lightly tighten clamp drive screw (B).
- ▶ Tighten actuator drive screw (A) expanding ID clamp .002 - .005" (.050 - .13mm).
- ▶ Machine clamp to size of your bore.
- ▶ Loosen actuator drive screw (A) aligning marks once again.
- ▶ Loosen clamp drive screw (B) approximately 1/8 turn.

Ready for use, load parts and tighten actuator screw. Do not exceed 45 ft/lbs of torque. Care should be taken not to over-tighten with the smaller diameter screws (M2, M4).

ACTUATOR DRIVE SCREW WITH RETAINING SNAP RING

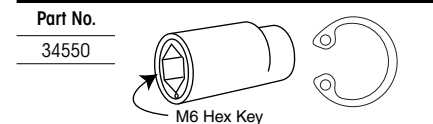

REPLACEMENT THREADED CYLINDER

	Part Number		
	Lathe 1" Shaft	Lathe w/25mm Shaft	Cylinder Thread
34502	34602	38602	M2
34504	34604	38604	M4
34506	34606	38606	M6
34508	34608	38608	M8
34510	34610	38610	M10
34512	34612	38612	M12

Mounting Screws not included.

Part Number	Thread Size
34002	M2
34004	M4
34006	M6
34008	M8
34010	M10
34012	M12

Modular XYZ Xpansion™ Pins



**PRESS FIT
NOW AVAILABLE
IN 12L14**



MITEE-BITE Products releases the new Modular XYZ Xpansion™ Pins for Tombstone, Grid Plate and Fixture Plate applications. The unique, patent pending design provides accurate location, repeatability and high holding forces for securing parts on the inside diameter. The XYZ Pin provides “out of the way workholding” and accessibility to all work surfaces with absolutely no external clamping interference. The Threaded Pin is available in standard sizes of 1/2, 5/8, M12 and M16 for tombstones and grid plates. The Press Fit Pins are available in 1/4, 3/8, 1/2, 5/8, M6, M10, M12 and M16 diameters for custom applications. Both styles of the pins are manufactured from “heat treatable” 17-4PH stainless steel. The Press Fit Pins are now also available in 12L14 mild steel. The Pins expand up to 0.030” (0.7mm) and the diameter can be machined for specific applications. The top of the Pins have a slight taper creating maximum line contact in bore and provides clearance during load/unload. Designed for quick set-ups on secondary operations, material coming off prep stations, water-jets or even applications outside of your machining centers!



Install pin body



Install tapered drive screw



Raw stock on pins



Op 1



Op 2 including c'bore on same fixture

Continuous Improvement Programs = Innovation!

PATENT PENDING #62/254,456

THREADED PINS in 17-4PH



Threaded XYZ Pins incorporate an internal rotary broached hex for simple installation and removal from a tombstone, grid plate or fixture plate. Threaded Pins may be installed in a drilled and reamed hole for precise location or set in a hardened drill bushing for additional strength and wear resistance.

To install a Threaded XYZ Pin in a precision bore, drill/tap accordingly and ream the hole over the nominal diameter minimum of +0.0001 to +0.0005". (+.003 to +0.013mm)

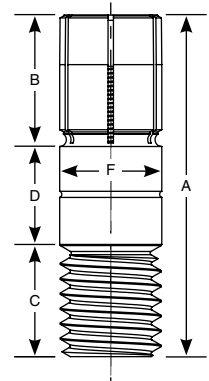

Part Number	External Thread	A	B	C	D	F (+/-) .000/.001" (.000/.025mm)	G*	Replacement Tapered Screw	Tapered Screw Thread x Length
31850	1/2"-13	1.625"	0.60"	0.53"	0.50"	.500"	0.413"	31010	1/4-20 x 1 1/4
38850	M12-1.75	40mm	15mm	13mm	12.00mm	12.00mm	10.5mm	38010	M6-1 x 30mm
31860	5/8" -11	1.875"	0.62"	0.62"	0.62"	.625"	0.472"	31020	5/16-18 x 1 1/4
38860	M16-2	45mm	16mm	13mm	16.00mm	16.00mm	12mm	38020	M8-1.25 x 30mm

*G minimum diameter pin can be machined or turned down to **Torque of Pin body needs to exceed torque of Tapered screw
Tapered screw included with pin.

PRESS FIT PINS *All sizes available in both 17-4PH and 12L14*



Pins are intended for press fit or close tolerance removable slide fit applications. Install in a precision bore or a bushing with the center threaded for the Tapered screw. If precise location is not necessary, pin can be used on top of fixture plate. An accessory kit

is available to make Installation and Removal (I/R) of the XYZ Pins quick and easy.

NOTE: If recessing pin into fixture beyond slits be sure to provide clearance for expanding segments.

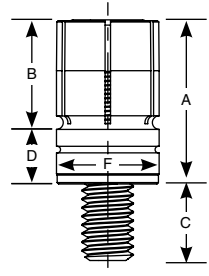

17-4PH Part Number	12L14 Part Number	Description	A	B	C	D	F (+/-) .000/.001" (.000/.025mm)	G*	Replacement Tapered Screw	Tapered Screw Thread x Length	Installation/Removal (I/R) Kit**
31730	31630	Press Fit 1/4"	.500"	0.27"	.29"	.23"	0.250"	.219"	31731S	5-40 x 5/8	31720
38730	38630	Press Fit 6mm	13mm	7mm	7.3mm	5.8mm	6.00mm	5.5mm	38731S	M3-0.5 x 16mm	38720
31740	31640	Press Fit 3/8"	.750"	0.50"	.33"	0.25"	0.375"	0.281"	31002S	8-32 x 7/8	31721
38740	38640	Press Fit 10mm	19mm	12.7mm	8.4mm	6.35mm	10.00mm	7.5mm	38002S	M4-0.7 x 22mm	38721
31750	31650	Press Fit 1/2"	.750"	0.50"	.45"	0.25"	.500"	0.413"	31010S	1/4-20 x 7/8	31722
38750	38650	Press Fit 12mm	19mm	12.7mm	11.1mm	6.35mm	12.00mm	10.5mm	38010S	M6-1 x 22mm	38722
31760	31660	Press Fit 5/8"	.750"	0.50"	.52"	0.25"	.625"	0.472"	31020S	5/16-18 x 7/8	31723
38760	38660	Press Fit 16mm	19mm	12.7mm	13mm	6.35mm	16.00mm	12mm	38020S	M8-1.25 x 22mm	38723

*G minimum diameter pin can be machined or turned down to **Kit includes screws (2) SHCS
Tapered screw included with pin.

SPECIFIC FEATURES/INSTALLATION



Figure 1

PRESS FIT INSTALLATION:

Place Pin in prepared bore, place I/R Tool over pin as shown in figure 1. Using the smaller socket head cap screw (SHCS) provided, thread into fixture to evenly draw down pin. Remove SHCS and replace with Tapered screw when ready to use.

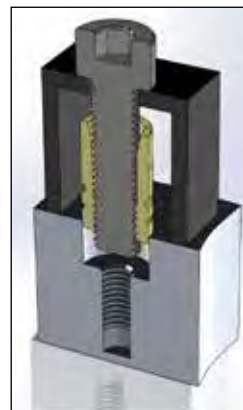

Figure 2

PRESS FIT REMOVAL:

Place the I/R Tool over the clamp as shown in figure 2, thread the larger SHCS into the "internal threads" of the Pin and tighten the screw to extract the Pin.

NOTE: It is recommended to fit Pin with a drill bushing when the Pin must be frequently removed. Or drill and ream the bore hole over the nominal diameter minimum of +0.0001 to +0.0005" (+0.003 to +0.013mm)

Loc-Down® System



FIG. 1

The Mitee-Bite Loc-Down® System was designed to be a programmer's and operator's dream for quickly and easily securing small to large aerospace parts. Its compact design allows for tighter pattern on grid plates compared to other options in the marketplace saving material cost on expensive aerospace alloys.

The Loc-Down® generates high holding force and provides low profile "out of the way" clamping allowing programmers to be very creative. Permits aggressive machining without tooling interference or applying forces that would influence part, intended to streamline production for the Aerospace Industry.

"We would have had to repair Brand-X 3 times in the past year and a half...and to date never had a problem with our Loc-Downs, we use these on 70% of our application."
Buffco Engineering

- ▶ Ideal for grid plates, tombstones and custom applications
- ▶ 100% Heat Treated Stainless Steel

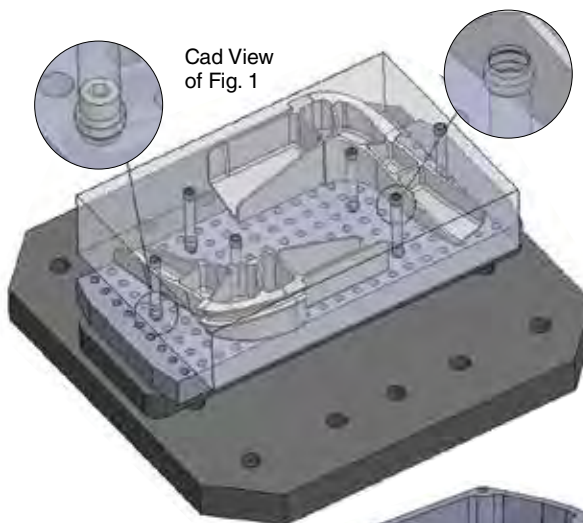

Cad View of Fig. 1

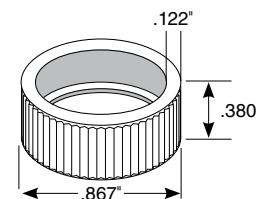

Heavy Wall Loc-Down® Bushing
Part No. 11520

Loc-Down®
1/2-13 - Part No. 11500
M12-1.75 - Part No. 11612



Loc-Down®
Custom Carbide Cutter
Part No. 11530

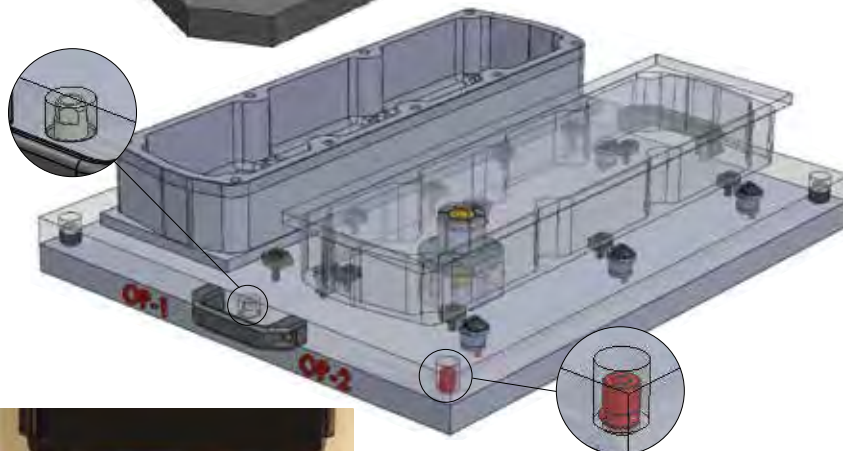

Part Number	Description	Size†
11500	Loc-Down®	1/2-13
11550	Loc-Down® Quick Change Kit*	1/2-13
11612	Loc-Down®	M12
11650	Loc-Down® Quick Change Kit*	M12
11530	Carbide Cutter	
11535	Loc-Down® Insertion Tool	
11520	Heavy Wall Loc-Down® Bushing	

Maximum Torque 15 Ft/Lbs (20 N.m.)

† - NEW Loc-Down® sizes available soon!



We have combined our Loc-Down®, custom Bushings and Locating Pins and Liners in a convenient kit (Part No.'s 11550 and 11650) that delivers a low-cost high precision quick change pallet system with a repeatability of .0004"/0.01mm or better.

Patent No. 8,920,063

Quick Change Receiver and Blank Pallet



NEW



Blank Pallet sold separately

MITEE-BITE announces the addition of a cost effective simple Quick Change Receiver System allowing for the rapid change out and precise location of small fixture pallets. The Mitee-Bite Quick Change Receiver is designed to accept any of our current pallets as well as the blank pallet shown. The receiver mounts on t-slot tables, tombstones, sub-plates and our Aluminum T-Slot Grid Plates. Special washers and mounting clamps are provided with the system.

- ▶ All hardware recessed allowing the receiver to be skim cut to perfectly match the table.
- ▶ Receiver furnished with diamond and taper pins and hardened liner bushings, threaded steel inserts, special washers and mounting clamps.
- ▶ Blank pallet is fastened to the receiver with our Loc-Down® System, two turns of the Loc-Down® releases the pallet. 100 lbs. of force for every foot pound of torque.
- ▶ The Loc-Down® is not removed from the receiver – lost cumbersome fasteners are a thing of the past.
- ▶ No protruding fastener above the surface of the pallet to interfere with tooling.
- ▶ High precision for a LOW COST solution!

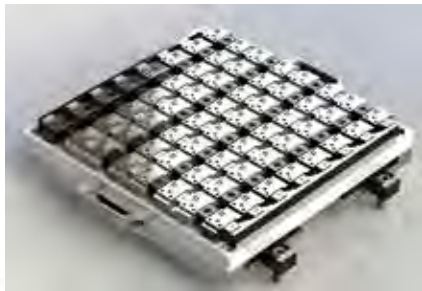

See the
*Q.C. Receiver
in action!*

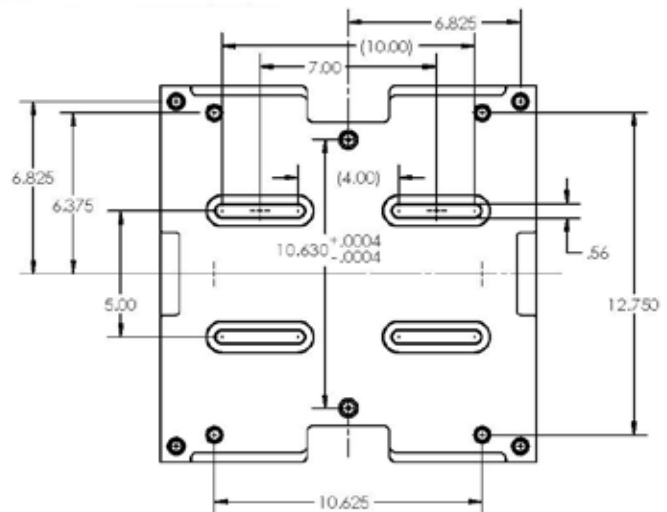

Part No. Description

46500	Quick Change Receiver with (4) 1/2-13 Loc-Downs® and Hardware
46600	Quick Change Receiver with (4) M12x1.75 Loc-Downs® and Hardware
46525	Quick Change 1" Blank Pallet with Liner and Loc-Down® Bushings Installed
11500	Loc-Down® (1/2-13)
11612	Loc-Down® (M12x1.75)
11520	Heavy Wall Loc-Down® Bushing
45070	Liner Bushings (2/pk)

Vacmagic® VM100



VM100 Base Unit (45375) in Vise



VM100 Base Unit (45375) with VM300 Vacuum Pallet (45150)



VM100 Base Unit (45375) on a Magnetic Chuck



VM100 Base Unit (45375) with a Production Pallet (VM100 Blank Pallet - 45325)

- ▶ Make your own vacuum fixtures - we can help with the design and produce the fixture for your custom application
- ▶ Will accept both blank pallets, the standard 45130 and the larger 45135, as well as the standard vacuum pallet, increasing your vacuum platform to over 14"x12" (360mmx315mm).
- ▶ Remove 12mm pins when grinding/machining thin material, use set screws to locate and aid in holding force

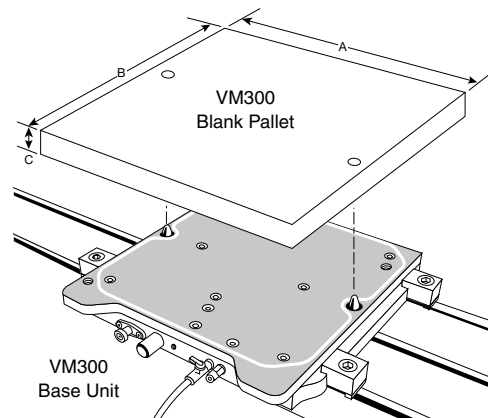
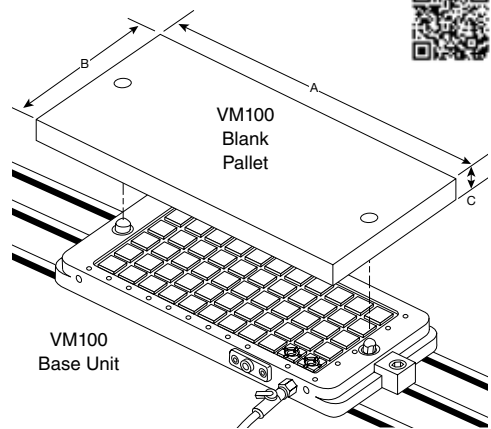

Part Number	Description	A - Length Inch (Metric)	B - Width Inch (Metric)	C - Height Inch (Metric)
PATENT NO. 7665717				
VM100				
45325	Blank Pallet	12.5 (318mm)	5.875 (150mm)	1.0 (25mm)
45375	Base Unit with all hardware	12.375 (315mm)	5.5 (140mm)	1.0 (25mm)
45300	VM100 Kit Includes: base unit, 2 blank pallets			
VM300				
45130	Blank Pallet	14.3 (360mm)	12.4 (315mm)	.75 (19mm)
45135	1" thick Blank Pallet	14.93 (379mm)	14.93 (379mm)	1.0 (25mm)
45150	VM300 Vacuum Pallet	14.3 (360mm)	12.4 (315mm)	.625 (16mm)
45160	VM300 Large Vacuum Pallet	33.625 (859mm)	14.5 (368mm)	.625 (16mm)
45175	Base Unit (Receiver) Includes: all hardware	12.75 (323mm)	13.0 (330mm)	1.375 (35mm)
45101	VM300 Kit Includes: base unit, 2 blank pallets, 1 vacuum pallet			

GASKET MATERIAL (for VM300 & VM100) See our website, MiteeBite.com, for installation tips

	Part No.	Description	(Inch) Diameter [†]
Black - Excellent for long cycles and aggressive coolants.	BLACK 45111	by the foot	.170*
	45115	by the foot	.070
	451181	by the foot	.125
	45119	by the foot	.188
White - Excellent for small parts, water based coolants or running dry.	WHITE 45114	by the foot	.170*
	45116	by the foot	.070
	45117	by the foot	.125

*Replacement size for base units and vacuum pallets. Other sizes listed for custom made pallets.

[†]Tolerance on all gasket diameter is +/- 10%.



The All-in-One Pallet Changer and Vacuum Chuck System

In a relatively short amount of time the VM300 has established itself as the vacuum system to which all others are measured. Capabilities include traditional vacuum applications using our standard grid plate and custom vacuum applications (ie: machining blank pallet to suit specific part geometry) and the ability to perform as a rock solid pallet changer. Contact us to schedule an in-house demonstration with one of our highly qualified Manufacturing Representatives.

*One Small Investment =
Huge Payoffs!*

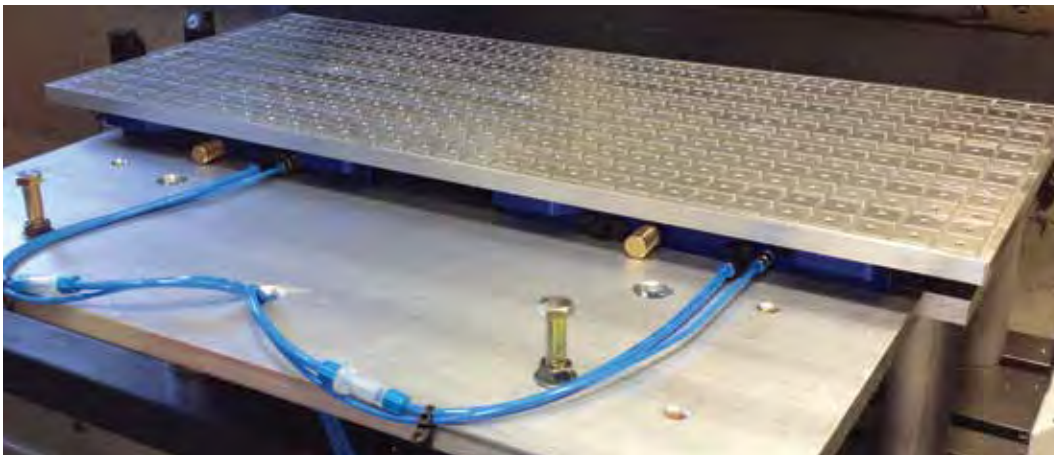

Best Workholding Product at MACH Exhibition 2006

See page 49 for Replacement Parts

Two VM300 Base Units (45175) and large Vacuum Pallet (45160), bolts supporting oversize workpiece.



VM300 Base Unit (45175) with a Production Pallet (VM300 Blank Pallet - 45130)

- ▶ Simple design keeps cost low
- ▶ Productivity maximized - load pallets while machining
- ▶ Quick-change - swap pallets in 30 seconds or less with precise repeatability
- ▶ Easy to install and set-up
- ▶ Vacuum pallets with M6 threaded holes and textured finish to increase friction
- ▶ Reliable and easy to use - virtually maintenance free
- ▶ Flexible pallet design - limited only by your imagination!
- ▶ No pumps - uses standard shop air
- ▶ Purchase includes a pack of our original Fixture Clamps and Sliding Stops
- ▶ If additional vacuum chambers are needed, drill tap through with M8 thread and plug when not required.



Custom application with graphite.

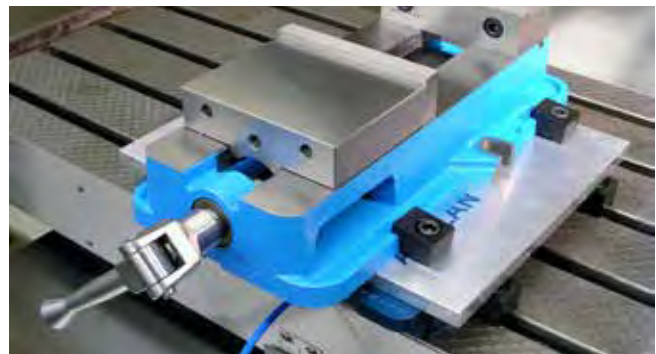

Never indicate your vise again!

Multi-Power Vac

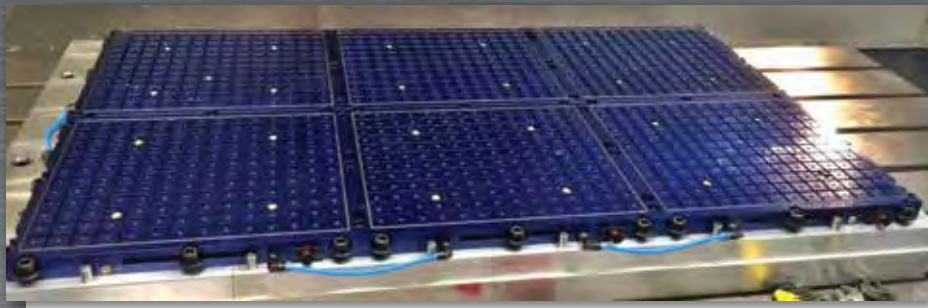

Designed to be easily linked together creating larger platforms

Mitee-Bite is proud to introduce possibly the most universal multi-functional vacuum system in today's market. This system has several unique features to meet your vacuum workholding needs.

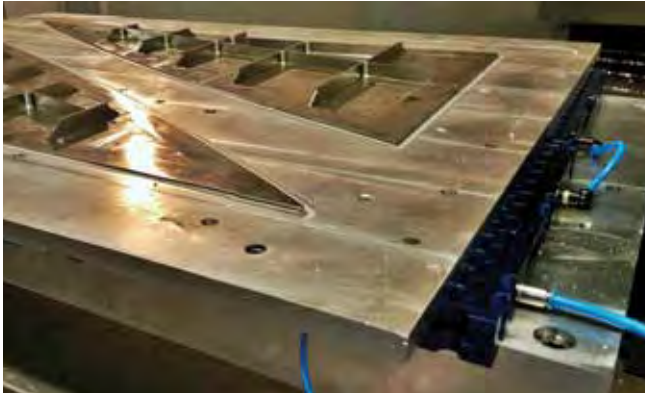

Multiple MPV's shown with large vacuum pallet.

- ▶ Can be powered with our Vacuum Generator (Shop Air) or Vacuum Pumps (page 45)
- ▶ 14"x 16" with textured surface creating additional holding force through friction
- ▶ 4 Vacuum ports allowing user to hold 1-4 small parts or 1 large part (ports can be plugged)
- ▶ Grid plate tapped with M6 threads allowing multiple workholding solutions
- ▶ 6 oversized steel washers machined below the bottom surface allows unit to be used for grinding operations on a magnetic chuck
- ▶ Multiple Vacuum Generators can be used on each pallet if additional CFM is desired
- ▶ Multiple pallets can operate from (1) vacuum generator
- ▶ Coolant Trap may be necessary when using external vacuum source (Trap sold separately)

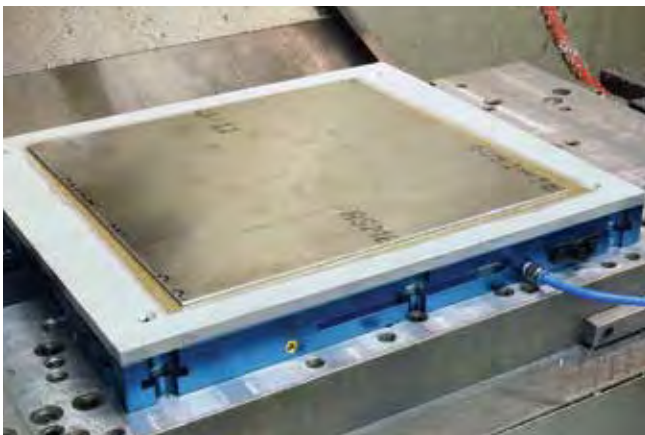

Application using Mitee-Grip™ with sacrificial top plate

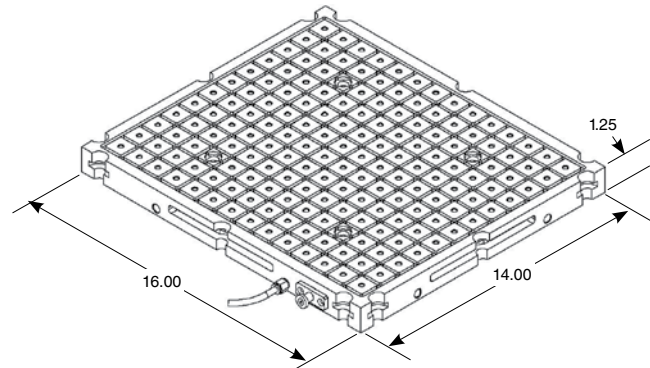
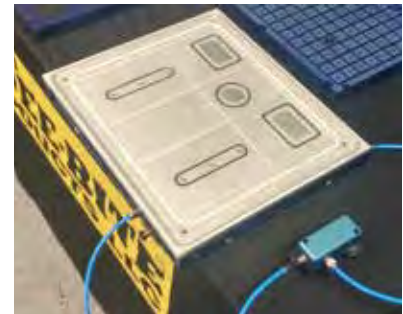

Part No.	Description
46000	1 Multi-Power Vac pallet with Vac Generator including all accessories
46100	Vac Generator with regulator/tubing/brass filter and push to connect fitting
46200	1 Multi-Power Vac pallet without Vac Generator including mounting hardware and tubing
46250	Sacrificial Top Plate with mounting screws
46050	Coolant Trap with hose and fittings

Rotary Vacuum Chuck



NEW



Yes, it's true! A vacuum system for your lathe or rotary table which provides an option for those applications that cannot be held by traditional methods. Although initially designed for thin materials and composites, we discovered we could machine more aggressively than anticipated with use of our newly designed vacuum grippers. These grippers will leave indentation on backside of workpiece, however increase the lateral load in some cases by more than 400%! Grippers can be raised/lowered/relocated as needed in the 32 M6 threaded holes on the face to include the ability to easily change the size of vacuum chamber by removing/reinstalling the gasket material from one of the 9 grooves. Always selecting the largest diameter possible for your application.



Manufactured from a solid billet ensures concentricity between the shaft and vacuum chambers, increased rigidity and the extra material needed if custom modification is required. For example: reducing the size of face plate or shaft diameter as well as machining mirror image of workpiece into faceplate for custom applications.

Rotary push to connect fitting designed for 1,100 RPM, however general machining practices and common sense must be considered when using this product. Recommended for light duty machining application - please contact us with any questions. Fittings are for 5/16 or 8mm tubing. If using on lathe, steel tubing is necessary with a coolant trap placed between vacuum pump and vacuum chuck. Flex tubing may be used on rotary table although steel tubing is always the preferred method.

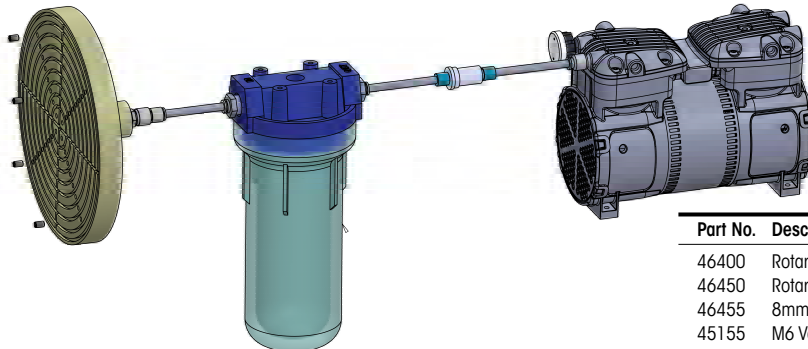

Part No.	Description	Diameter	Thickness
46400	Rotary Vacuum Plate with M6 tapped holes	9.85"	1.0"
46450	Rotary Sacrificial Plate	9.85"	0.375"
46455	8mm Rotary fitting		
45155	M6 Vacuum Grippers (2/pk)		
45111	Vacuum Gasket (black) sold by foot	.170"	
46401	Rotary Vacuum Kit (includes Vacuum Plate, Rotary Fitting, 4 Vacuum Grippers, Tubing and Gasket)		

See page 45 for Vacuum Pump information.

TalonGrip™ Vise Jaws

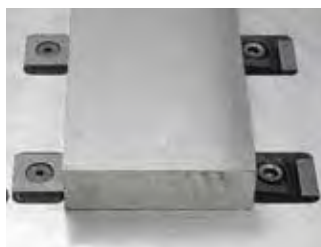

Fixture application with Pitbull® Clamps



Soft jaws

Mitee-Bite Products introduces a new and innovative product that will increase the functionality of your standard 4, 6, and 8 inch (100mm, 150mm and 200mm) vises. TalonGrip™ is a simple bolt on system that will allow you to perform aggressive machining operations while clamping on as little as .060 (1.5mm) of an inch. Ideal for small lot sizes, difficult applications or proto-type work when building a fixture would not be beneficial. TalonGrips™ are also available individually for fixturing with Pitbull® and Dyna-Force® Clamps or for soft jaw applications.

For more versatility, all Jaw Sets are tapped with 2 additional holes to accept our M4 Pitbull® Clamps (M6 for 32088). This is an effective solution when downforce or additional holding force is necessary.

Jaws are not heat-treated to allow for custom modifications. All grips and stops are heat-treated A2 steel.



Multiple parts



Large part

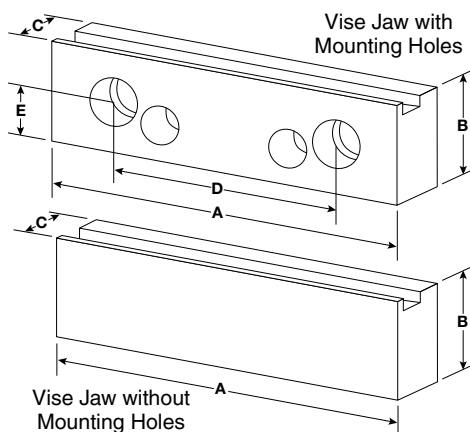
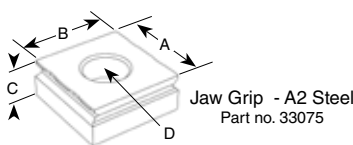
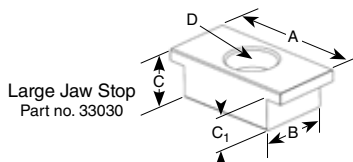
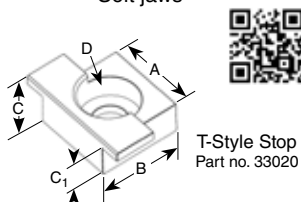

GRIPS & STOPS

	Part No.	Description	A	B	C	C ₁	D	Recommended Gripping Height	No. Per Pack
INCH	32050	Extra Grips	.75	.500	.250	-	10-32	.060-.075	2
	32020	Extra Stop	.75	.500	.250	.195	10-32	-	1
	32075	Fixture Grips	.75	.750	.312	-	10-32	.060-.120	2
	32100	Fixture Grips	.75	1.000	.312	-	10-32	.060-.120	2
	32150	Fixture Grip	1.00	1.000	.500	-	5/16-18	.060-.220	1
METRIC	33050	Extra Grips	19.05	12.7	6.35	-	M5	1.5mm-1.9mm	2
	33020	Extra Stop	19.05	12.7	6.35	4.95	M5	-	1
	33030	Extra Stop	19.05	12.7	7.92	5.72	M5	-	1
	33075	Fixture Grips	19.05	19.05	7.92	-	M5	1.5mm-3.0mm	2
	33100	Fixture Grips	19.05	25.4	7.92	-	M5	1.5mm-3.0mm	2
	33150	Fixture Grip	25.4	25.4	12.7	-	M8	1.5mm-5.6mm	1



STEEL VISE JAW SET (Set includes 4 TalonGrips™, 1 stop with M5 screws)

Part Number	Vise (metric)	A (metric)	B (metric)	C (metric)	D (metric)	E (metric)	Replacement	
							Grips	Stops
WITH MOUNTING HOLES								
32044	4" (100mm)	4.0 (100)	1.48 (37.59)	1.0 (25.4)	2.5 (63.5)	.688 (17.47)	33050 (2/pk)	33020 (1 ea.)
32066	4 1/6" (100mm/150mm)	6.0 (150)	1.73 (43.94)	1.0 (25.4)	2.5/3.88 (63.5/98.55)	.688/.94 (17.47/23.87)	33050 (2/pk)	33020 (1 ea.)
32068	6" (150mm)	8.0 (200)	1.73 (43.94)	1.0 (25.4)	3.88 (98.55)	.94 (23.87)	33050 (2/pk)	33020 (1 ea.)
32088	6 7/8" (150mm/200mm)	8.0 (200)	2.45 (62.23)	1.25 (31.75)	3.87/4.75 (98.3/120.65)	.94/1.218 (23.88/30.94)	33075 (2/pk)	33030 (1 ea.)
WITHOUT MOUNTING HOLES								
33044	-	4.0 (100)	1.48 (37.59)	1.0 (25.4)	-	-	33050 (2/pk)	33020 (1 ea.)
33066	-	6.0 (150)	1.73 (43.94)	1.0 (25.4)	-	-	33050 (2/pk)	33020 (1 ea.)
33068	-	8.0 (200)	1.73 (43.94)	1.0 (25.4)	-	-	33050 (2/pk)	33020 (1 ea.)



VersaGrip™, as the name implies, offers the versatility of clamping standard vise work as well as providing a solution for difficult applications that would normally require fixturing or machining soft-jaws. By simply replacing your current jaws with the VersaGrip™ system you can securely hold odd shaped parts while machining at speeds and feeds you never thought possible.

This system can accommodate a wide range of part sizes as well as holding multiple parts in a single cycle. The hardened (52-54 RC) VersaGrip™ has penetrating teeth designed to bite into your workpiece preventing lateral and horizontal movement. These grips will hold flame cut parts, castings, even parts with a negative draft!

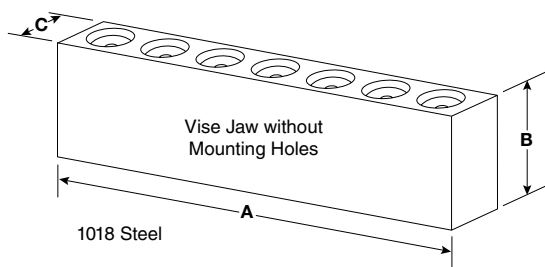
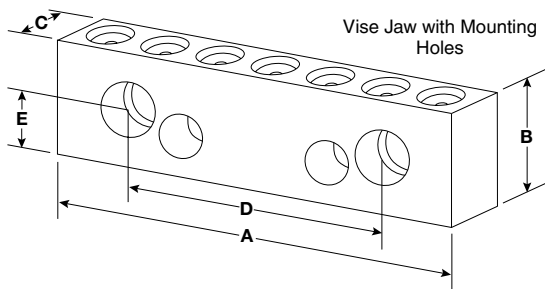

Odd shaped parts



Tombstone application



TALONGRIP & VERSAGRIP 6" COMBO KIT

33006 6" Combo Kit

Contents of Kit

32066 Talongrip™ Vise Jaw Set

32166 VersaGrip™ Vise Jaw Set

NOTE: All jaws designed to fit on a 4" or 6" vise.

STEEL VISE JAW SET (Set includes 4 VersaGrips™ with M5 Screws)

Part Number	Vise (metric)	A (metric)	B (metric)	C (metric)	D (metric)	E (metric)	Holes
WITH MOUNTING HOLES							
32166	4"/6" (100mm/150mm)	6.00 (150)	1.88 (47.75)	1.0 (25.4)	2.5/3.88 (63.5/98.55)	.688/.94 (17.47/23.87)	7
32168	6" (150mm)	8.00 (200)	1.88 (47.75)	1.0 (25.4)	3.88 (98.55)	.94 (23.87)	9
WITHOUT MOUNTING HOLES							
33166	-	6.00 (150)	1.88 (47.75)	1.0 (25.4)			
33168	-	8.00 (200)	1.88 (47.75)	1.0 (25.4)			

VERSAGRIP™

	Part No.	A	B	C	Recommended Gripping Height	No. of Grips Per Pack
INCH	33175	.750	.375	10-32	.060-.140	2
METRIC	32175	19.05	9.52	M5	1.55mm-3.5mm	2

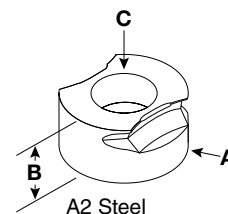

Loc-Jaw® System

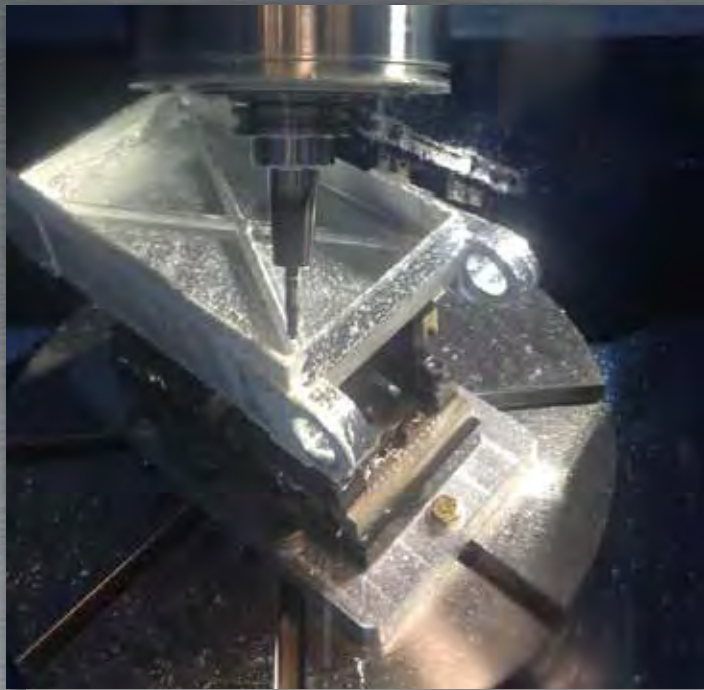

The Loc-Jaw® system was conceived to simplify, and allow greater tooling access and more versatility securing your parts when 4th and 5th axis machining. Designed to hold raw stock without a pre-op using the carrier method. New Combo Edge Grippers incorporate both Knife and Blunt-Edges in one grip.

- ▶ Unique design allows access to bottom of workpiece
- ▶ Ability to hold parts from .500" to 4.00" or up to 1 Meter with optional extension kit
- ▶ 6,000+ lbs of holding force gripping on only .125" of material
- ▶ Knife Edge side of grippers designed to penetrate into material up to .060" deep. Blunt-edge side of grippers with our Tungsten Carbide coating are recommended for high speed machining on hard alloys. All grippers heat treated A2.
- ▶ Centering Disk included for Loc-Jaw® base
- ▶ Set of locating pins included. (Liners installed in base - see page 43)



Torque (Ft/lbs)	Holding Force (lbs)
10	2,000
15	3,000
20	4,000
25	5,000
30	6,000

*Max torque of 25 ft. lbs. using Knife Edge grippers on material > 40Rc due to point contact.

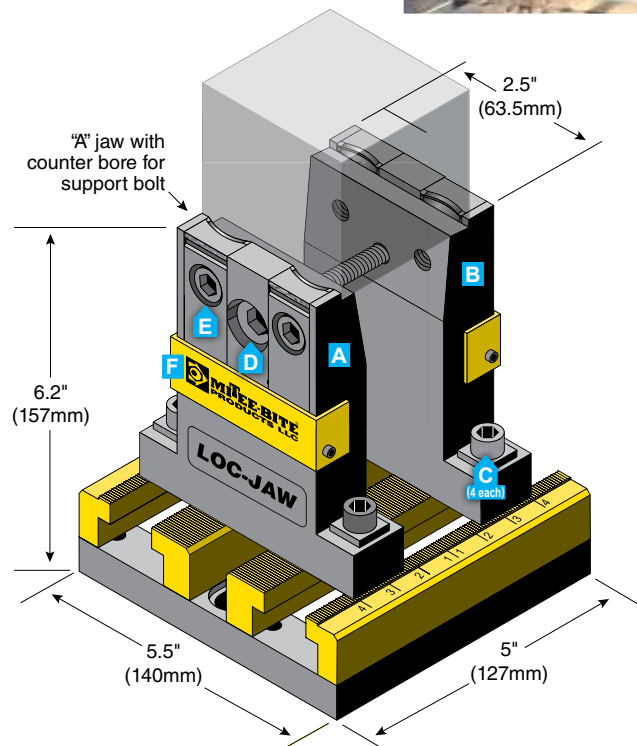

Part Number	Description
14500	Loc-Jaw® System Ships fully assembled with all tools required
14525	Loc-Jaw® Extension Kit Includes base plate with rails, threaded rod 1 meter long and locking nut with spacer

REPLACEMENT PARTS

Part Number	Description
14501	Loc-Jaw® Support Bolt #1 (M10 x 45mm)
14502	Loc-Jaw® Support Bolt #2 (M10 x 65mm)
14503	Loc-Jaw® Support Bolt #3 (M10 x 90mm)
14504	Loc-Jaw® Support Bolt #4 (M10 x 110mm)
14508	Loc-Jaw® Combo-Edge Grippers - 1 side knife edge, 1 side blunt edge with Tungsten Carbide coating (2 per pack)
14518	Loc-Jaw® Jaw Set - includes 2 Jaws, 4 Combo-Edge Grippers & Screws
14520	Loc-Jaw® Rail Set - includes 4 Rails, Screws, Dowel Pin

PATENT 9,216,484,132

Tall Vise Jaws/Towers



These Vise Jaws/Towers are designed to mount directly to your 4 or 6 inch vise elevating your workpiece into the 5 axis envelope. You already have the platform therefore this becomes a very simple and low cost solution. This is the only system on the market where you can loosen the vise and double the holding force!



The Towers are exceptionally versatile due to the incorporation of our TalonGrip™ and VersaGrip™ Grippers and Pitbull® clamps. Secure round or square stock easily by using a vise or by mounting towers directly to your t-slot or grid table. Low profile gripping saves material cost and no workpiece preparation saves machine and labor cost.

WISE APPLICATION

- ▶ Mount jaws to either 4 or 6 inch vise with MITEEBITE.COM facing outboard keeping mounting bolts loose.
- ▶ Determine which grippers will be used, install and tighten grippers hand tight. If VersaGrips™ are being used to grip round stock, place in outboard bores. Do not tighten screws at this point. Tighten vise lightly onto workpiece allowing jaws to center themselves, adjust VersaGrips™ and tighten gripper screws and mounting bolts for both jaws.
- ▶ Loosen vise jaw for load/unload clearance of workpiece. Install support/pivot bolt.
- ▶ Setup is complete. Tighten support bolt allowing grippers to penetrate .010-.060" on material < 40Rc.
- ▶ For additional holding force, loosen vise handle which will eliminate any jaw lift that may have occurred and depending on amount of torque can increase pressure to over 9,000 lbs.

T-SLOT & GRID TABLE APPLICATION

- ▶ Using vertical counter bores on outboard edges of jaws, install mounting bolts into t-nuts or grid plate and adjust accordingly. Do not tighten at this time.
- ▶ Select appropriate support bolts and install in upper horizontal counter bore and thread into opposite tower.
- ▶ Select grippers based on configuration suggestions below.
- ▶ Place workpiece between jaws and lightly tighten upper support bolt until all grippers contact workpiece. Tighten vertical mounting bolts.
- ▶ Loosen upper support bolt 1 full turn or until adequate workpiece clearance is obtained.
- ▶ Upper support bolt is now the "drive bolt" for securing and releasing workpiece.
- ▶ Any size t-nuts can be utilized. We provide 16mm t-nuts (most popular size) which also fits 5/8 t-slots.

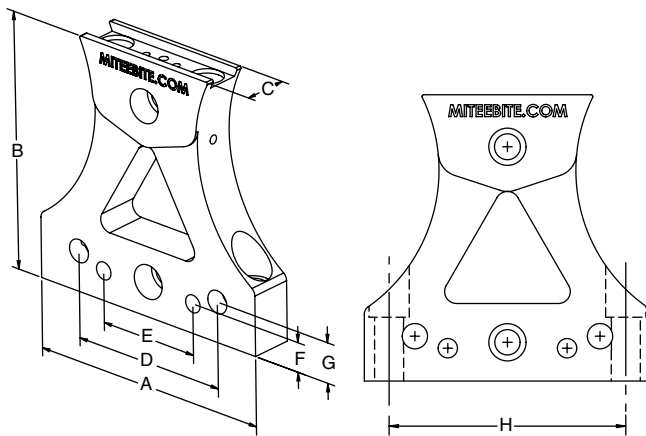

GRIPPER CONFIGURATIONS

- ▶ Round stock: use 4 VersaGrips™, two in each outboard bore. Adjust so all "points" make contact simultaneously. If small diameter workpiece, two parts may be held at one time.
- ▶ Maximum of 8 TalonGrips™ can be used, 4 in each jaw for maximum line contact.
- ▶ If down force is necessary or additional holding force use 2 Pitbull® clamps. One in the center of each jaw and one TalonGrip™ on each side of Pitbull® clamps. Tighten jaws into grippers then tighten each Pitbull® clamp.

COMBO KIT CONTENTS:

- 2 Jaws
- 4 Talongrip™ 3/4" grippers with M5 screws
- 4 Versagrip™ grippers with M5 screws
- 1 Talongrip™ 3/4" stop with M5 screw
- 2 Pitbull® blunt edge clamps with M6 screws
- 2 M12 x 200mm support bolts
- 2 M12 x 100mm support bolts
- 2 M12 x 65mm support bolts
- 4 M12 x 55mm mounting bolts
- 4 M12 x 16mm T-nuts

Part No.	Description	Vise size	Mtg. Bolts	A	B	C	D	E	F	G	H
32266	6" jaw set	4 or 6"	M12x55mm SHCS	6.00"	6.00"	1.06"	3.88"	2.50"	0.69"	0.94"	4.96"
	150mm Jaw Set	100mm/150mm		150.00mm	150.00mm	26.92mm	98.55mm	63.50mm	17.53mm	23.88mm	125.98mm

PATENT PENDING #62/257,028

Kopal® Clamps



Need a quick and easy way to clamp parts with top pressure? Check out this versatile line-up of clamps! From the strong but compact Piccolo to the heavy-duty Big Block.

The worm and gear design ensures the clamps will not loosen with use yet the clamps are easy to set up and break down. This is ideal for short cycle times and odd shaped parts.

The modular design also allows adjusting clamping height by stacking the riser blocks, and the use of an extension arm increases reach!

For the complete line of Mono-Bloc style clamps, see our website:

MiteeBite.com

PICCOLO

- ▶ Up to 1460 lbs. (6500N) Holding Force
- ▶ 21.6 ft. lbs max. clamping torque

When the arm is released, the Piccolo remains in position in the slot.

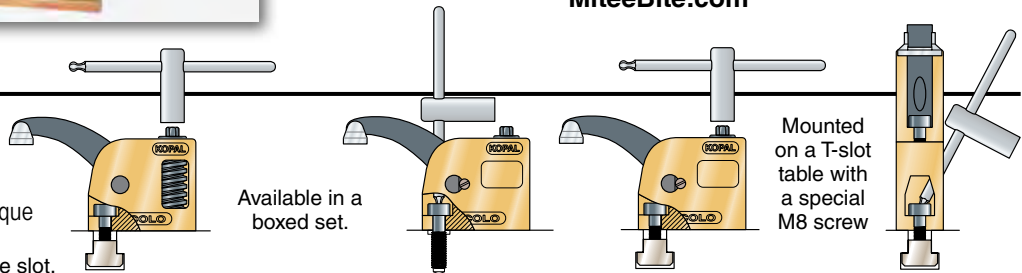

Available in a boxed set.

Mounted on a T-slot table with a special M8 screw

MONO BLOC

- ▶ Up to 3600 lbs. (16000N) Holding Force
- ▶ 58 ft.lbs max. clamping torque

1. Slide the T-nut and the screw into the slot
2. Position and tighten the clamp onto the table using the clamping key provided
3. Clamp the workpiece using the same key
4. Proceed with machining

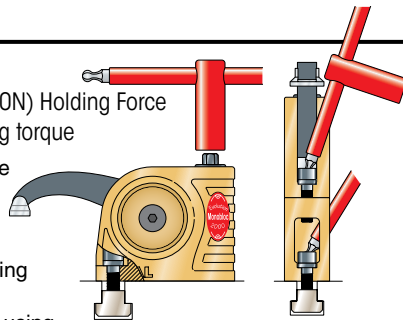

Mounted on a T-slot table with a special M10 screw

MONO BLOC CHAIN

- ▶ Up to 3600 lbs. (16000N) Holding Force
- ▶ 58 ft.lbs max. clamping torque

The 1 meter of chain allows for clamping large workpieces.

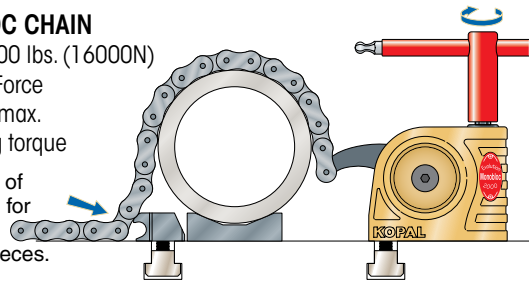

BIG BLOCK

- ▶ Up to 9000 lbs. (40000N) Holding Force
- ▶ 50 ft.lbs max. clamping torque

When the workpiece is released, the Big Block can either remain fixed in the slot, or slide in the slot.

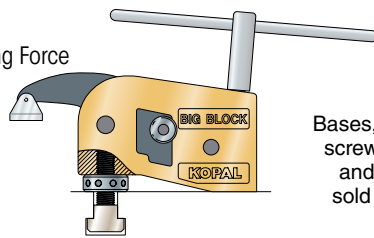

Bases, riser blocks, screws, cylinders and t-nuts are sold separately.

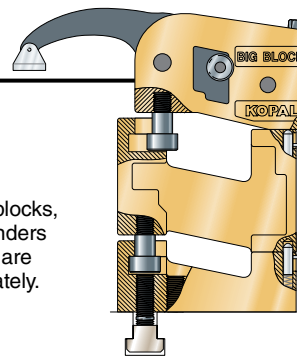

Quick mounting and release

Mounted on base and riser block with adaptor and special screw

	Part Number	A	B	C	D	E
Piccolo	25500	-.60" - 2.28"	2.125"	2.5"	1.250"	2.87"
Standard Duty	25705	0" - 4"	2.375"	3.5"	1.563"	4.25"
Chain	25040	0" - 4"	2.375"	3.5"	1.563"	4.25"
Big Block	08035	-.70 - 5.32"	5.700"	4.1"	2.350"	6.38"

Mono-Bloc with extension arm increases range to 5 1/2".

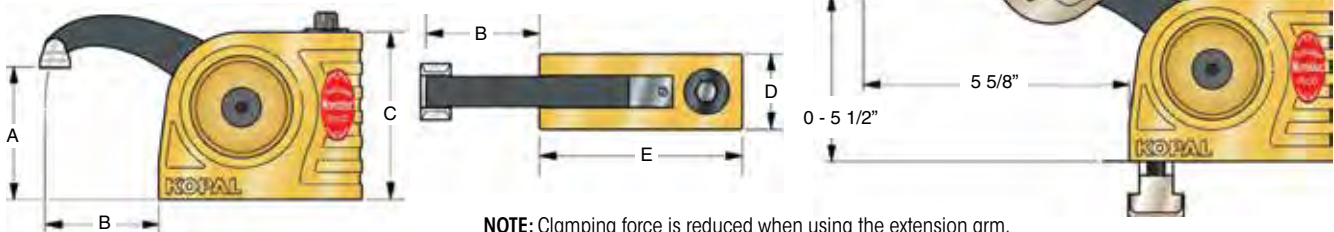

NOTE: Clamping force is reduced when using the extension arm.

REPLACEMENT SWIVEL SHOES



Shoes #2 & #3 give you a larger clamping surface. Shoes #4 & #5 are for holding round workpieces.

Part Number	Model
25518	#2
25520	#3
25522	#4
25524	#5
25530	Set of all 4

For the complete line of Mono-Bloc style clamps, see our website:
MiteeBite.com

DELUXE MONO-BLOC START-UP KIT



Kit includes: (2) standard-duty Mono-Bloc Clamps with 2 5/8" arm, (2) standard-duty Riser Blocks,

- (1) Extension Arm,
- (1) standard-duty T-Wrench,
- (2) M10x35mm screws,
- (2) M10x40mm screws,
- (2) T-nuts (choose from chart at right)

Part Number	T-Slot Size
25725	1/2
25727	9/16
25729	5/8
25731	3/4

High-impact plastic storage/ carrying case with room to store above tools, and space to store additional T-nuts for other size mills.

SPECIAL SCREWS AND T-NUTS FOR MONO-BLOC AND MONO-BLOC CHAIN CLAMP

(Order one screw and one nut per Mono-Bloc)

INDIVIDUAL MONO-BLOC ITEMS

Part Number	Description
25705	Standard-Duty Mono-Bloc Clamp with 2 5/8" Arm (Includes T-wrench)
25710	Standard-Duty Riser Block
25515	Replacement Swivel Shoe
25720	T-Wrench for Standard-Duty Mono-Bloc
25540	Extension Arm
25310	Worm Gear

Part Number	Description
25730	M10x35mm Screw for 9/16 T-Nut
25733	M10x40mm Screw for 5/8 & 3/4 T-Nut
25736	M10x45mm Screw for 13/16 & 7/8 T-Nut
25747	1/2xM10 T-Nut (12mm)
25748	9/16xM10 T-Nut (14mm)
25751	5/8xM10 T-Nut (16mm)
25754	3/4xM10 T-Nut (18mm)
25757	13/16xM10 T-Nut (20mm)
25760	7/8xM10 T-Nut (22mm)

Mono-Bloc Chain Clamp



Application with large cylindrical piece.

The Mono-Bloc Chain Clamp is a simple and rapid workholding solution for a wide array of applications.

The Chain Clamp offers fast and powerful clamping with forces to 3,600 lbs. (16000N).

Additional lengths of chain can be added for large applications.

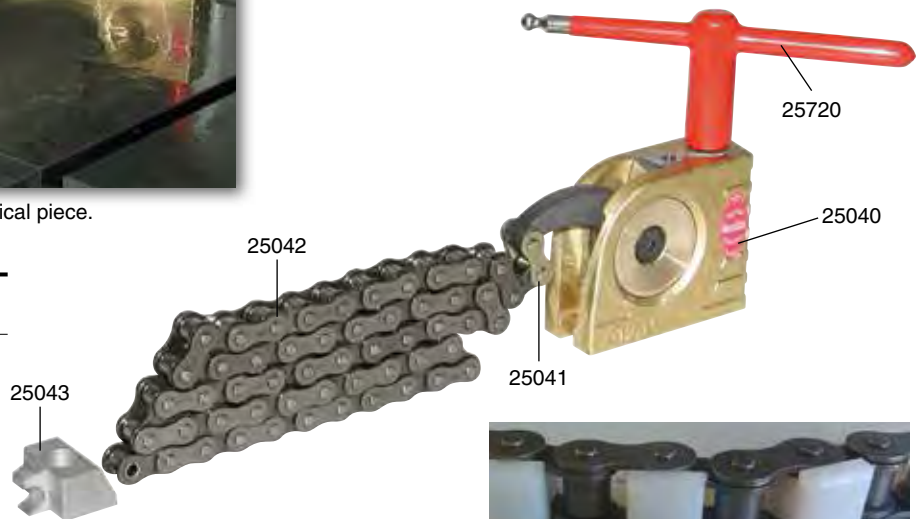

Part Number	Description
25040*	Mono-Bloc Chain Clamp with Master Link, 5 Protective Clips, Anchor, Key and 1 Meter of Chain
25041	Master Link
25042	Extra Chain (1 meter)
25043	Anchor
25045	Protective Clips (5/pk)
25720	Wrench

*Includes (2) M10 mounting screws for anchor and clamp.

T-nuts sold separately - see above.



To prevent marring or scratching on delicate pieces use the protective chain clips. (25045) Minimum radius 6"

Locating Rails for Jigs and Fixtures

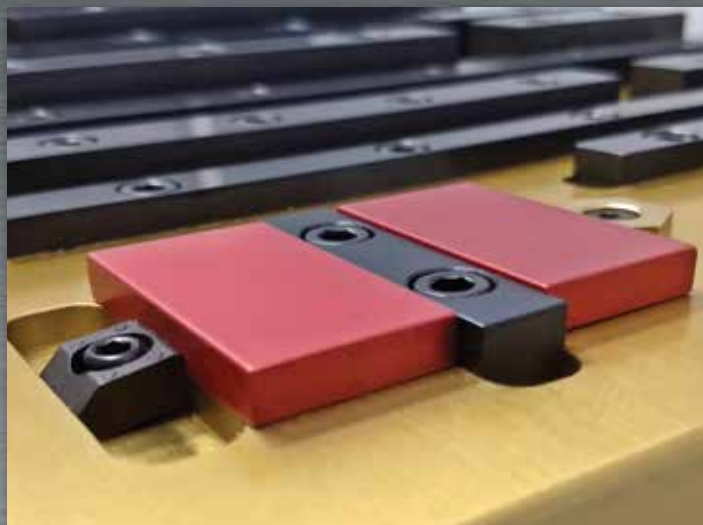

Locating rails are made of low carbon steel and are precision ground square. They are available in a number of sizes and lengths to suit most applications.



Locating rails used with Machinable Uniforce® and Pitbull® Clamps

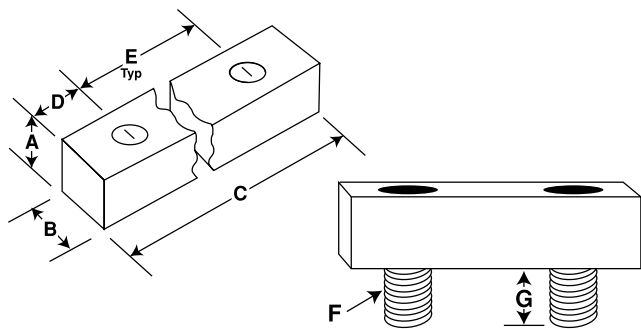

	Part Number	A	B +/- .0005	C	D	E	F	G	No. Holes
INCH	33110	.35	.480	.750	.NA	.NA	1/4-20	.38	1
	33120	.35	.480	2.00	.50	1.00	1/4-20	.38	2
	33140	.35	.480	4.00	1.00	1.00	1/4-20	.38	3
	33160	.35	.480	6.00	.75	1.50	1/4-20	.38	4
	33180	.35	.480	10.00	1.00	2.00	1/4-20	.38	5
	33200	.48	.730	3.00	.75	1.50	1/4-20	.38	2
	33220	.48	.730	6.00	.75	1.50	1/4-20	.38	4
	33240	.48	.730	10.00	1.00	2.00	1/4-20	.38	5
	33260	.73	.980	3.00	.75	1.50	3/8-16	.62	2
	33280	.73	.980	6.00	1.00	2.00	3/8-16	.62	3
	33300	.73	.980	10.00	1.00	2.00	3/8-16	.62	5
	33320	.98	1.230	6.00	1.00	2.00	1/2-13	.75	3
	33340	.98	1.230	10.00	1.25	2.50	1/2-13	.75	4
	33360	1.48	1.980	6.00	1.00	2.00	1/2-13	.75	3
33380	1.48	1.980	10.00	1.25	2.50	1/2-13	.75	4	

Mounting Screws included.

Is it taking too long to make a fixture to increase production?

Mitee-Bite Products makes fixture building easier and quicker with the addition of ready made locating rails.

Rails are made of low carbon steel, then ground square. They are easily machined when used with our machinable clamps. Tungsten Carbide coating can be added to increase holding force.

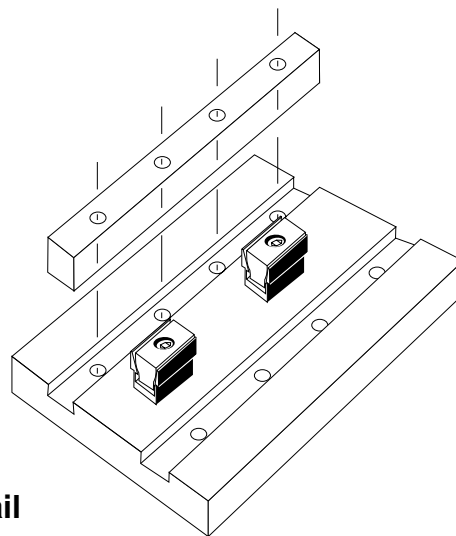

Locating Rail Installation:

1. Mill a slot to locate the rail.
Depth of the slot will determine rail height.
2. Drill and tap the required holes to mount the rail.
3. For better rigidity, the rail should be pinned to the fixture plate with dowel pins.
4. If rails are to be machined to hold round pieces, the clamps should be mounted and both rail and clamp machined at the same time.

	Part Number	A	B + .000 - .013	C	D	E	F	G	No. Holes
METRIC	83200	12	15	50	15	20	M6	11mm	2
	83210	12	15	100	20	30	M6	11mm	3
	83220	12	15	150	30	30	M6	11mm	4
	83240	12	15	250	25	50	M6	11mm	5
	83260	18	24	75	20	35	M10	18mm	2
	83280	18	24	150	30	30	M10	18mm	4
	83300	18	24	250	25	50	M10	18mm	5

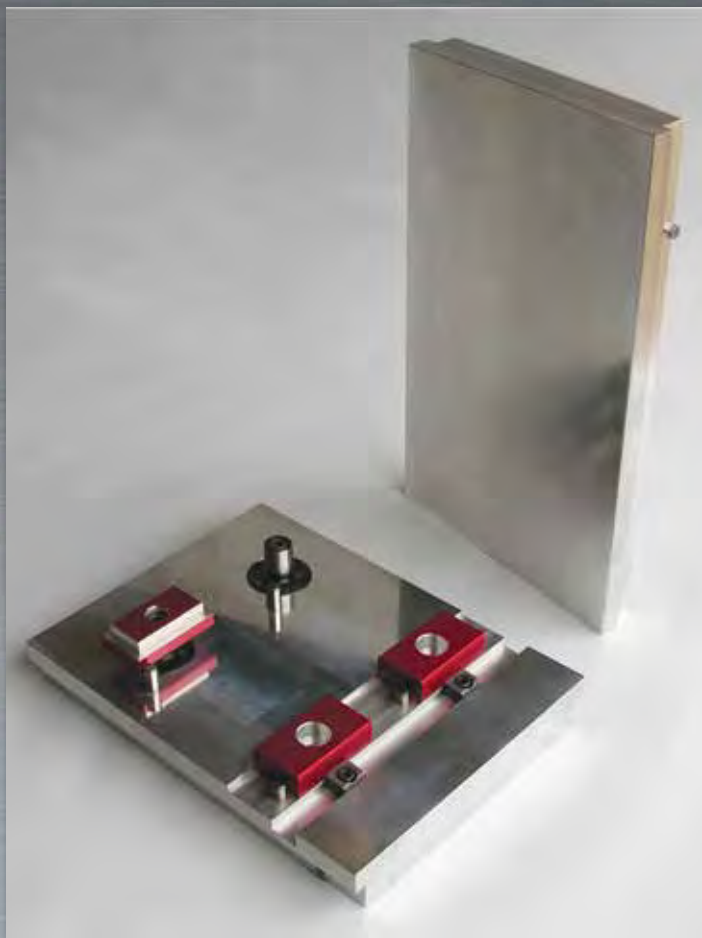

- ▶ Now you can run fixture jobs without removing your vises.
- ▶ Vise Pallets are designed to fit in all 6 inch (150mm) vises and measure approximately 6x8 and 6x10 inches (150x203mm and 150x254mm).
- ▶ Ideal for multiple small parts using one of several Mitee-Bite low profile edge clamps.
- ▶ The Vise Pallets are qualified in 2 places so they can rest on parallels or on the top of the jaws.

HOW TO USE

The Mitee-Bite Vise Pallet has a locating pin that makes contact with the left side of the solid jaw for repeat location of pallet. Simply slide pallet to the right of the vise and clamp in place. Pallets can be machined and tapped as required.



Vise Pallet with ID Xpansion™ Clamps



Fixtured with Mitee-Bite Uniforce® Clamps and locating rails



Fixtured with Mitee-Bite Machinable Uniforce® Clamps

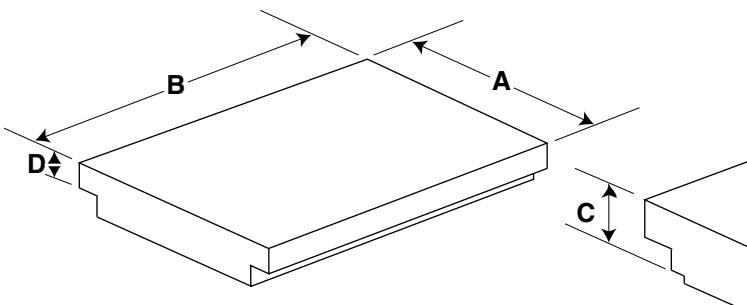

Part Number	A (metric)	B (metric)	C (metric)	D (metric)
24100	6.00 (150)	8.00 (203)	.95 (24.4)	.44 (11.2)
24120	6.00 (150)	10.00 (254)	.95 (24.4)	.44 (11.2)

Aluminum T-Slot Plates

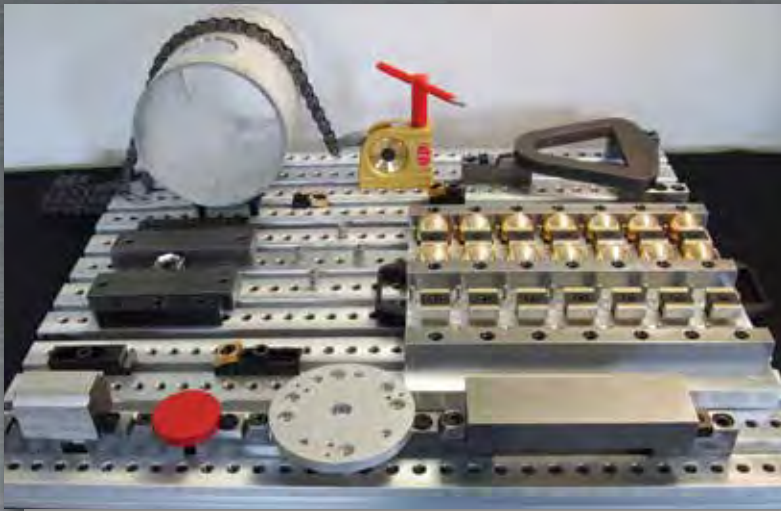

Our standard T-Slot Plates provide a low cost solution to transform your grid plates, cmm's and even drill presses into a more universal platform. All of our modular clamping systems that use 5/8 and 16mm t-nuts can be easily used on this platform, from the basic and still popular clamps that started Mitee-Bite 30 years ago to some of the strongest clamps in the industry including unique solutions using chain clamps and vacuum workholding. Our T-Nut Rail below is drilled and tapped for some of our quick change systems and also has precision 12mm bores for our diamond and taper pins, so now you have the possibilities of using this as a quick change platform. Take a look at our social media network when considering new methods, these guys and gals showcase true talent and creativity.

- ▶ Standard T-slot plates can be ordered in custom lengths up to 66" (1676mm), not machined
- ▶ Standard sizes are premachined to .005 (.13mm) flatness and parallelism per foot (300mm)

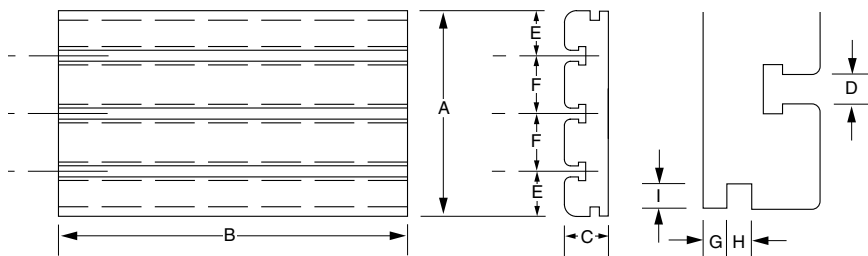

STANDARD T-SLOT PLATE without Mounting Holes

Part Number	A x B x C (metric)	T-slots	D (metric)	E (metric)	F (metric)	G (metric)	H (metric)	I (metric)	Lbs. (KG)
22913	9.0 x 13.0 x 1.48 (228 x 330 x 38)	3	5/8 (16)	2.00 (50.8)	2.50 (63.5)	.49 (12.7)	.50 (12.7)	.50 (12.7)	13.3 (6.1)
22918	9.0 x 18.0 x 1.48 (228 x 457 x 38)	3	5/8 (16)	2.00 (50.8)	2.50 (63.5)	.49 (12.7)	.50 (12.7)	.50 (12.7)	18.5 (8.5)
22924	9.0 x 24.0 x 1.48 (228 x 610 x 38)	3	5/8 (16)	2.00 (50.8)	2.50 (63.5)	.49 (12.7)	.50 (12.7)	.50 (12.7)	24.8 (11.3)

T-NUT RAIL



Using this T-Nut Rail with our Aluminum T-Slot Plates provides more mounting configurations with our standard clamps as well as serving as a simple pallet changer when the Locating Pins are installed. Center-line dimensions for pins are the same as all our blank pallets used with our

Vacmagic® product line, will also locate our VM300 and Multi-Power Vac which have liners installed in the bottom of units again with same center-line dimensions. 4 set-screws lock rail and place, depth of threaded holes set for Loc-Downs®.

- ▶ Available in 16" (406mm) lengths with 1/2-13 or M12 Threads

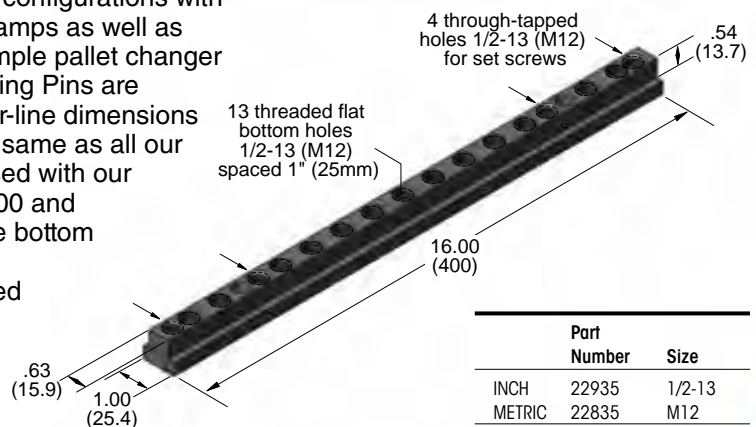

	Part Number	Size
INCH	22935	1/2-13
METRIC	22835	M12

Locating Pins and Liners



Use our Diamond and Tapered pins to standardize your shop with a universal pattern, allowing fixtures to be quickly mounted to any machining center.

- ▶ Designed with simplicity in mind - easy to install and remove
- ▶ Available with Inch or Metric hardware
- ▶ Use with Loc-Downs® for low cost quick change system
- ▶ Cylindrically ground
- ▶ Heat treated 8620

Part Number	Description
51000	Set of pins with M4 screws
52000	Set of pins with 8-32 screws
45070	Liners (2/pk)



Mounting Clamps



Mounting clamps are designed for securing MITEE-BITE Aluminum Sub Plates, Vacmagic® and many types of machine vises.

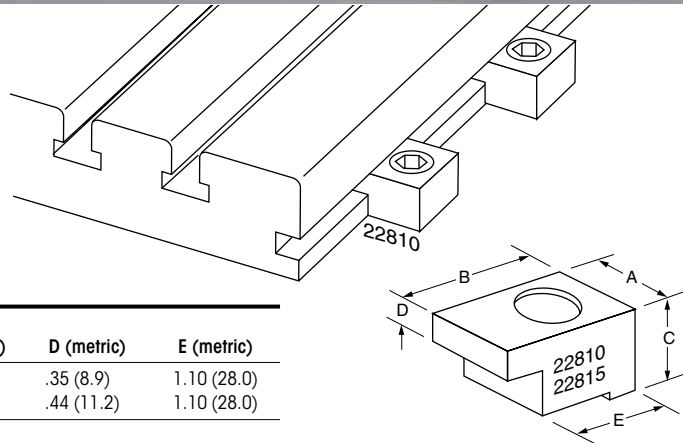

Part Number	Screw Size (metric)	A (metric)	B (metric)	C (metric)	D (metric)	E (metric)
22810*	1/2 (M12)	1.25 (31.8)	1.50 (38.1)	.87 (22.1)	.35 (8.9)	1.10 (28.0)
22815**	1/2 (M12)	1.25 (31.8)	1.50 (38.1)	1.25 (31.8)	.44 (11.2)	1.10 (28.0)

*For Vacmagic® VM100 **For Vacmagic® VM300

Spring Loc™ and Sliding Stop™



The Spring-Loc™ is an extremely low profile (.072") adjustable clamp capable of producing approximately 10 lbs. of clamping pressure depending on how much the flex arm is compressed in the locked position. The center slot allows 360° positioning. The back end of the Spring-Loc™ is "V" shaped allowing customers to run parts in series for engraving, laser etching and provides a simple and quick method for locating and holding parts for CMM and Vision Systems.

The Sliding Stop™ was primarily designed to assist in vacuum workholding applications allowing customers to run at higher feeds and speeds. We incorporated a scallop on the edge of the Stop which aids in better viewing with CMM and Vision Systems.

Part No.	Description	Screw	Sold
42000	Spring-Loc™ Kit (Includes 4 Clamps & Stops)	1/4-20	Kit
42100	Spring-Loc™ Clamp	1/4-20	2/pk
42200	Sliding-Stop™ (1"x3", .0734)	1/4-20	4/pk
44000	Spring-Loc™ Kit (Includes 4 Clamps & Stops)	M6	Kit
44100	Spring-Loc™ Clamp	M6	2/pk
44200	Sliding-Stop™ (1"x3", .0734)	M6	4/pk

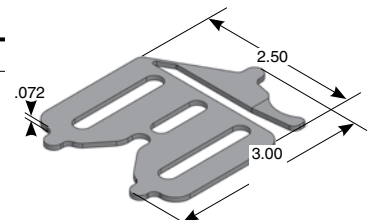

Strap Clamps



This low profile design promotes superior clamping in both normal and restricted areas with minimal tooling interference.

- ▶ Heat treated 17-4 P.H. stainless steel
- ▶ Guaranteed for life

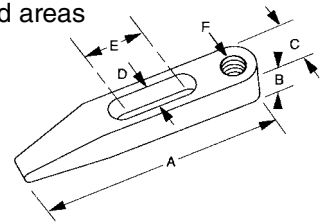

	Part Number	A	B	C	D	E	F	Holding Force (Lbs)
INCH	35100	3.63	.43	.89	.400	.86	3/8 Dia. PIN	3,200
	35200	5.00	.75	1.00	.530	1.36	1/2-13	6,000
	35300	6.00	.86	1.20	.650	1.50	5/8-11	8,600
	35400	7.00	1.06	1.40	.780	1.50	3/4-10	15,700
(N.)								
METRIC	36100	92	11	22.6	10.4	22.0	9.5 Dia. Pin	14234
	36200	127	19	25.4	13.4	34.5	M12	26689
	36300	152	22	30.5	16.5	38.1	M16	38254
	36400	178	27	35.6	19.8	38.1	M20	69837

Collet Wrenches



The MITEE-BITE Collet Wrench simplifies insertion and removal of collets in the spindle nose on CNC lathes.

The MITEE-BITE Collet Wrench is manufactured with a steel head and fins for greater strength and durability. The bright red handle makes it easy to locate and is designed to be comfortable to the hand. The collet wrenches are available for 5C, 16C and 3J collets.

Part Number	Collet Sizes	Fins	A	B	C	D	E	F	G
1005C	5C	3	4.25	1.25	.50	.25	.28	1.13	.052
1016C	16C	3	4.25	1.75	.50	.25	.50	1.13	.052
1003J	3J	4	4.25	1.75	.50	.25	.50	1.13	.052

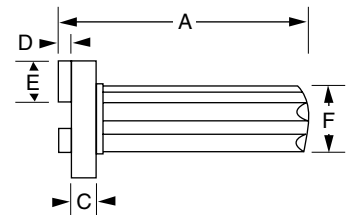
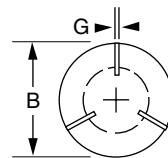

Collet Stop



The MITEE-BITE "front" loading Collet Stop is the most convenient 5C Collet Stop on the market. Once seated, the collet need not be removed for adjustment.

- ▶ Quick changing and easy to use
- ▶ Non clogging design
- ▶ Saves time and money
- ▶ Self centering
- ▶ Perfect for NC setups
- ▶ Reusable for different jobs

Part Number	Length (metric)
10105	24 (610)

Vacuum Pump



We now offer an Electric Vacuum Pump/Air Compressor option for use with all of our vacuum systems or your current system. This unit is compact, quiet and guaranteed to run continuously for 1 year!

The Pump produces a high evacuation rate of 5 cfm which is recommended for larger parts or difficult gasket sealing situations as the pump can compensate for gasket leakage much better. At dead head the vacuum pump develops approximately 12-13 psi of vacuum holding force. Mitee-Bite recommends using our Coolant Trap between fixture and pumps, so that any liquid that bypasses the gasket can be captured so not to affect vacuum performance.

The Pump is available operating on 115 volt or 230 volt and includes our coolant trap, air filter, non-skid feet & 10' power cord with on/off switch. The 230 volt cord will have flying leads* due to the wide variety of plugs.

*No plug on end of cord.

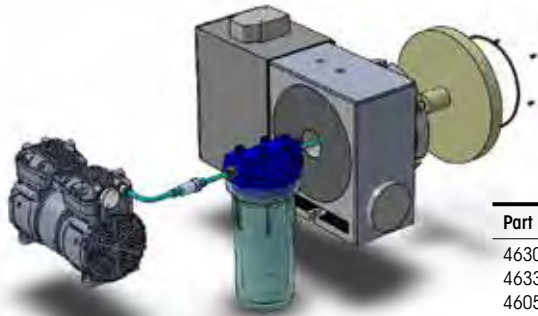

Part No.	Description
46300	Vacuum Pump/Air compressor wired 115 volt Coolant Trap, fittings, hoses & hardware included
46330	Vacuum Pump/Air compressor wired 230 volt Coolant Trap, fittings, hoses & hardware included
46050	Coolant Trap with hose and fittings

Chip Hooks



The chip hook is an essential safety tool for all shops. These galvanized steel hooks are fitted with a protective polyethylene hilt and wooden handles to ensure a firm grip. Available in several lengths and single or double handles.

SINGLE HANDLE HOOK WITH PROTECTING HILT

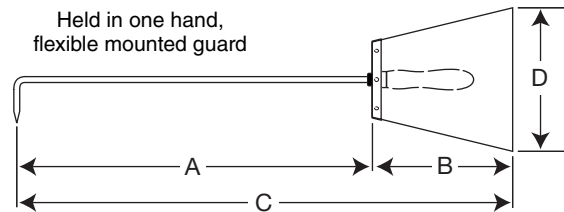

DOUBLE HANDLE HOOK WITH PROTECTING HILT

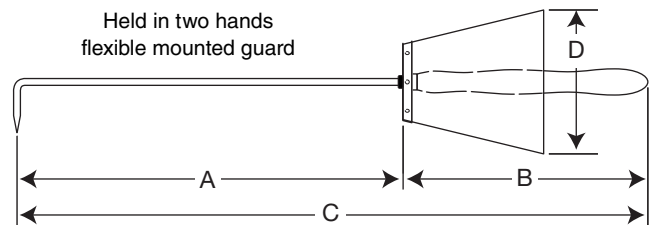

Part Number	Description	A (metric)	B (metric)	C (metric)	D (metric)
SINGLE HANDLE					
12060	Chip hook, single handle	15.75 (400)	7.0 (180)	22.5 (570)	7.0 (180)
12070	Chip hook, single handle	20.0 (500)	7.0 (180)	26.0 (670)	7.0 (180)
DOUBLE HANDLE					
12080	Chip hook, double handle	20.0 (500)	13.0 (320)	32.0 (820)	7.0 (180)
12090	Chip hook, double handle	31.5 (800)	13.0 (320)	44.0 (1120)	7.0 (180)
12100	Chip hook, double handle	39.0 (1000)	13.0 (320)	52.0 (1320)	7.0 (180)

SAFETY! A work related accident can happen very easily. Always use a chip hook to clear away annoying chips and empty the chip trays on your machines.

Replacement Parts

CAM SCREWS

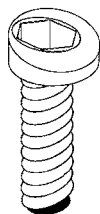

Part Number	Replacement Screw for Part Number	Minimum Order
10363	10202	10
10364	10203	4
10365	10204, 10504	10
10366	10207	10
10367	10201	10
10368	10213	4
10369	10205	10
10370	23140, 24106	4
10371	10206, 10506	10
10372	23150, 24108	4
10373	10208, 10508	8
10374	Series 9, 22588B	4
10375	10210	4
10376	24110	4
50363	50204	10
50364	50205	4
50365	50206	10
50366	50207	4
50367	50208	10
50368	53140, 54110	4
50369	50210	10
50371	50212	8
50372	T-Slot Toe Clamps	4
50373	50216	4
50374	54116	4

HEX WASHERS (for Fixture Clamps)



Part Number	Replacement Washer for Part Number (Metric)	Minimum Order
10580	10202, (50204)	10
10587	10207	10
10582	10204, (50206)	10
10583	10203, (50205)	4
10584	10201, 10205, (50208)	10
10585	(50207)	4
10586	10206, (50210)	10
10588	10208	8
10590	(50212)	8
10592	10210, (50216)	4

KNIFE EDGE WASHERS



Part Number	Replacement Washer for Part Number (Metric)	Minimum Order
12584	22584, (82584)	10
12588B	22588B, (82588)	8
12592	22592, (82592)	4

MACHINING SCREWS (for Machinable Fixture Clamps)

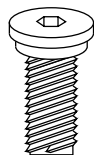

Part Number	Hold Down Screw for Part No.		Min. Order	Part Number	Hold Down Screw for Part No.		Min. Order
	Part No.	Order			Part No.	Order	
INCH							
10704	10504	4		50806	50506	4	
10706	10506	4		50810	50510	4	
10708	10508	4		50812	50512	4	
10710	10510	4		50816	50516	4	
METRIC							

MACHINABLE WASHERS - Steel (for Machinable Fixture Clamps)

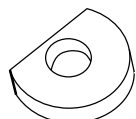

Part Number	Replacement Washer for Part Number (Metric)	Minimum Order
10604	10504, (50506)	4
10606	10506, (50510)	4
10608	10508	4
10610	10510, (50516)	4
10612	50512	4

TAPERED SCREW (for ID Xpansion™ Clamp and XYZ Expansion® Pin)

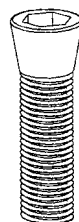

Part Number (Metric)	Screw For:	Minimum Order
31001 (38001)	Model #00	4
31002 (38002)	Model #0	4
31010 (38010)	Model #1	4
31020 (38020)	Model #2	4
31032 (38032)	Model #3	4
31042 (38042)	Model #4	4
31052 (38052)	Model #5, #6	2
31072 (38072)	Model #7, #8, #9, #10	2

MACHINABLE UNIFORCE® CHANNEL

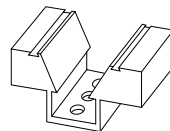

Part Number	Model	Minimum Order
60140	500	1
60125	750	1
60135	1000	1
60160	1500	1
60180	2000	1

MACHINABLE UNIFORCE® LOCKING PLATE

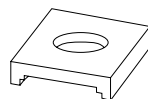

Part Number	Model	Minimum Order
60143	500	1
60145	750	1
60155	1000	1
60165	1500	1
60185	2000	1

UNIFORCE® CHANNEL

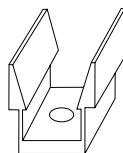

Part Number	Model	Minimum Order
60205	250	6
60207	375	6
60210	500	8
60220	750	6
60230	1000	4
60240	1500	2
60245	2000	2

UNIFORCE® STEEL WEDGE

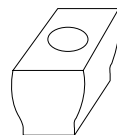

Part Number	Model	Minimum Order
60305	250	6
60307	375	6
60310	500	8
60320	750	6
60330	1000	4
60340	1500	2
60350	2000	2

SQUARE WASHERS

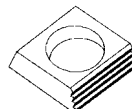

Part Number (Metric)	Use With Cam Screw: (Metric)
21006	10370 (MB-10M)
21016 (51016)	10372 (MB-12M)
21026	10376 (MB-16M)

SLOT WASHERS



Part Number	Use with Mounting Screw: (Metric)
20014	1/2-13 (M12 Screw)
20016	5/8 (M16 Screw)

THREADED CYLINDERS

Part Number	Thread
34002	M2
34004	M4
34006	M6
34008	M8
34010	M10
34012	M12

THREADED CYLINDERS

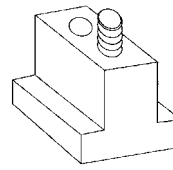

	Part Number	T-Slot Size	Minimum Order
INCH	10714	3/8	2
	10715	7/16	2
	10716	1/2	2
	10717	9/16	2
	10718	5/8	2
	10719	11/16	2
METRIC	50708	8mm	2
	50710	10mm	2
	50712	12mm	2
	50714	14mm	2
	50716	16mm	2
	50718	18mm	2
	50720	20mm	2
50722	22mm	2	

VM100, VM300 REPLACEMENT PARTS



Part No.	Description
45010	Brass filter/ea.



Part No.	Description
45040	Low pressure trip switch assembly/ea.



Part No.	Description
45070	Bushings for custom pallets - 2/pk



Part No.	Description
45015	In-line filter/ea.



Part No.	Description
45045	Vacmagic O-rings (3/pk, 2 small & 1 large)



Part No.	Description
45075	Base alignment pins - 2/pk



Part No.	Description
45020	Mounting bracket for 4mm/6mm tubing/ea.



Part No.	Description
45050	Supply valve/ea.



Part No.	Description
45080	4mm blue tubing - 15 ft/pack



Part No.	Description
45025	Locating pins/ Pack (1 taper & 1 diamond)



Part No.	Description
45055	Special mounting washer/ea.



Part No.	Description
45085	6mm blue tubing - 12 ft/pack



Part No.	Description
45030	Low vacuum indicator with spring/ea.



Part No.	Description
45060	LPTS fitting (Base Unit) Closed/ea.



Part No.	Description
45090	6mm tubing QD fitting for regulator/ea.

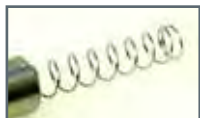

Part No.	Description
45031	Spring for low vacuum indicator/ea.



Part No.	Description
45065	LPTS fitting (Block) Open/ea.

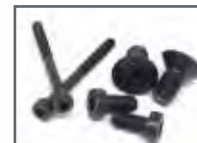

Part No.	Description
45095	Assorted mtg. hardware for location pins, alignment pins & LPTS block



Part No.	Description
45035	LPTS switch/ea.



Part No.	Description
45094	Vacuum Grease

**NEW
PRODUCTS**

SOON TO BE AVAILABLE!

Pinch Block

A simple solution for holding parts on the outside diameter. Use with our Talongrip™ for a multi-op fixture block. Designed to be mounted on plates for high-density fixturing or anyway you wish.



Snap-Down

An extremely versatile precision locking/locating pin with a pre-set pressure designed for the most demanding or delicate applications. Actuate from top or bottom, manually or hydraulically. Snap plate or part on pin and it will hold in place allowing “hands-free” tightening.

PATENT PENDING



X-Plate

Another exceptionally versatile product for multi-axis machining! Capable of holding round or square material with the low profile 6,000 lbs. Pitbull® clamps or Talongrips™ and Versagrips™ on the opposite side. Also designed for Modular XYZ Xpansion™ Pins and Loc-Down® Clamps for holding parts or even attaching a Raptor Fixture!

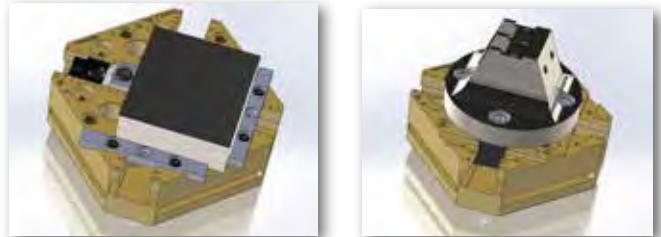

Steel Threaded Bushings

Precisely locate your Modular XYZ Xpansion™ Pins and Loc-Down® Clamps in this all-in-one bushing/insert. Will strengthen your threads and provide an accurate locating method for plates or custom mounting platforms.



Vac-Bloc

Providing vacuum options for parts that are not flat! Machinable blocks are precisely located in gasket slots and secured with four M6 screws into threaded pads of vacuum pallet, opening up new possibilities for vacuum workholding.

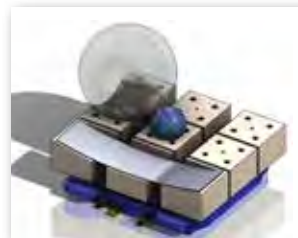

Broached Tapered Screws

Designed to allow tightening of our ID Xpansion™ Clamps from the back side when you cannot access the top of the clamp. A simple, yet effective solution for blind hole applications or creative fixturing.



Customer Applications

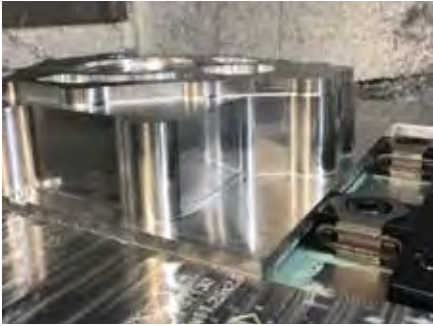

Master Machine Manufacturing - Bixby, OK



Morganoliff - Instagram

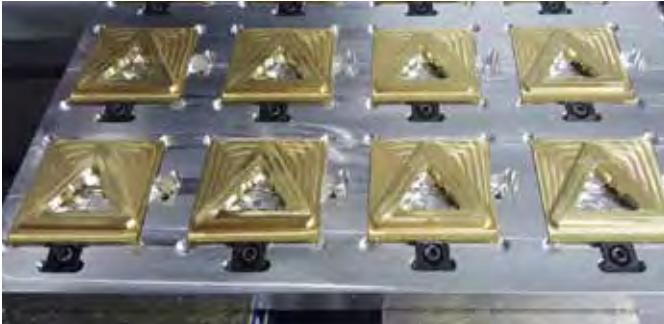

Juan Calderon - JC Manufacturing Inc.



Juan Calderon - JC Manufacturing Inc.



Shawn - St. George - Instagram

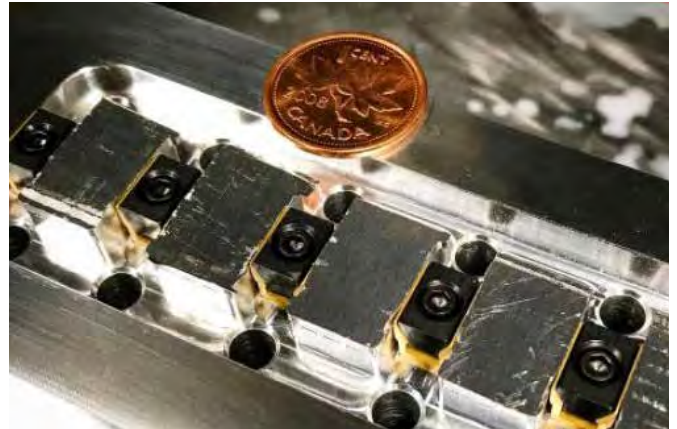

Karve Machine - Instagram

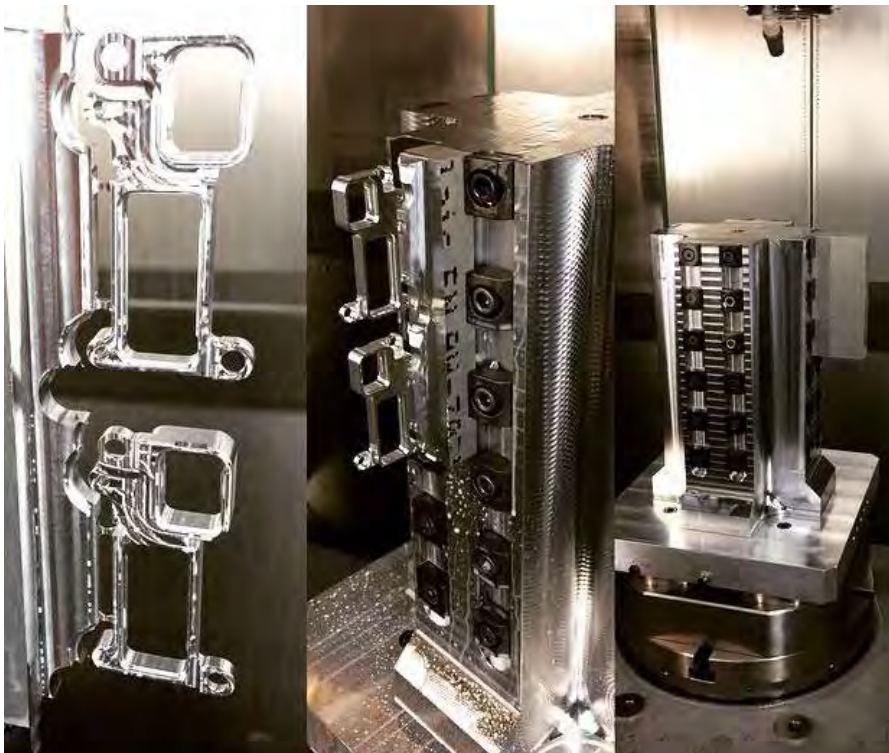

Dennis Van Kessel - CNC Solution

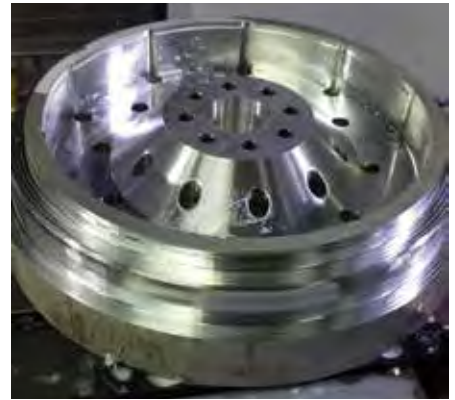

Autosports Engineering - Instagram



Shawn Armstrong - Instagram



Travis Robert - Instagram

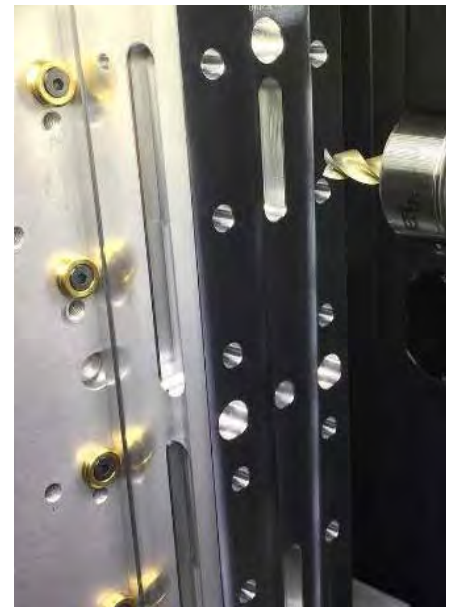

Savi Beeson - Instagram



Scan QR code
to see more
application images



Proto-Cut CNC
Machining -
Instagram



Dillan King - Instagram



WORLDWIDE DISTRIBUTION

Servicing over 200 COUNTRIES

Customer Satisfaction Our #1 Priority!

Technical and Design Assistance Includes
Top Level CAD Layouts Ready for Your Cam Software



340 Route 16B • P.O. Box 430
Center Ossipee, NH 03814 U.S.A.

Phone: (603) 539-4538
Fax: (603) 539-2183
Toll Free: 1-800-543-3580
E-mail: miteebite@miteebite.com

Visit our website to view our
latest product information:
MiteeBite.com

MITEE-BITE PRODUCTS LLC IS DISTRIBUTED BY:

