

Q X HAWK



Imageur industriel flexible d'identification automatique

Le QX Hawk est le premier imageur au monde à intégrer pleinement la technologie à lentille liquide, permettant une mise au point extrêmement flexible. Comblant l'écart entre facilité d'utilisation et performances, le QX Hawk offre un système de zoom optique modulaire à haute résolution, un décodage X-Mode performant et une connectivité instantanée simple. L'imageur QX Hawk lit facilement tous les codes à barres et symboles 2D, y compris les codes à marquage direct (DPM) 2D difficiles, dans tout type d'environnement, quelques secondes seulement après son installation.

QX Hawk : points forts

- Décodages/seconde : jusqu'à 60
- Plage de lecture : varie en fonction du modèle
- Autofocus à lentille liquide et zoom modulaire
- Port Ethernet intégré
- Options de configuration : 0.4MP CMOS ou 1.3MP CCD



Programme de configuration convivial ESP® : la solution logicielle à point unique permet de paramétrer et de configurer facilement et rapidement tous les lecteurs Microscan.



Bouton EZ : permet de paramétrer et de configurer le lecteur sans ordinateur.



Indicateurs visibles : les indicateurs de performances incluent un indicateur de « bonne lecture » vert clignotant et des DEL.



Plate-forme QX : le système à connexion rapide et la technologie X-Mode fusionnent pour assurer une connectivité simple, une mise en réseau et un décodage à hautes performances.

Pour plus d'informations sur ce produit, visitez www.microscan.com.

QX Hawk : symbologies

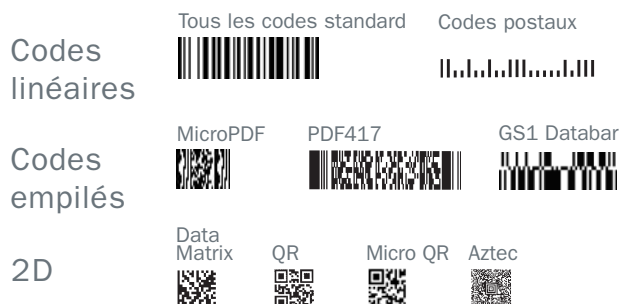

Décodage de tout type de symbole

Le QX Hawk utilise les algorithmes de décodage X-Mode supérieurs pour capturer de façon cohérente les codes à marquage direct à faible contraste, endommagés ou autres codes difficiles, des symboles Data Matrix de haute densité allant jusqu'à 3,3 mil. aux codes à barres linéaires de très grande taille.

Performances élevées

Le QX Hawk intègre un processeur ARM/DSP double cœur permettant une capture des images ultra rapide ainsi qu'une configuration et une communication en temps réel. Le traitement intégré, combiné à trois entrées/sorties rapides provenant directement du lecteur, permet au QX Hawk de fournir des fonctions de contrôle au niveau des lignes.

Facilité d'utilisation

En plus de sa petite taille permettant un positionnement souple, le QX Hawk inclut des DEL visibles, un système de ciblage laser, un indicateur de « bonne lecture » vert clignotant et un bouton EZ pour un paramétrage et une configuration instantanés.

Système optique avancé

La technologie d'imagerie avancée inclut un système de zoom optique modulaire à haute résolution permettant au QX Hawk de lire les marquages à des distances allant de 20 mm à 800 mm et plus. Combiné à un autofocus à lentille liquide en attente de brevet, le QX Hawk couvre facilement presque toutes les applications d'identification automatique.

Protocoles Ethernet

Protocoles Ethernet intégrés inclus pour les communications à haut débit.

Conception robuste

Le QX Hawk offre une conception industrielle robuste avec un boîtier IP65/67 en alliage moulé et des connecteurs M12.

Exemples d'applications

- Cartes de circuits imprimés
- Assemblages électroniques et fabrication de semi-conducteurs
- Automobile
- Aéronautique
- Appareils médicaux

MICROSCAN®

QX HAWK FLEXIBLE, INDUSTRIAL IMAGER

SPECIFICATIONS AND OPTIONS

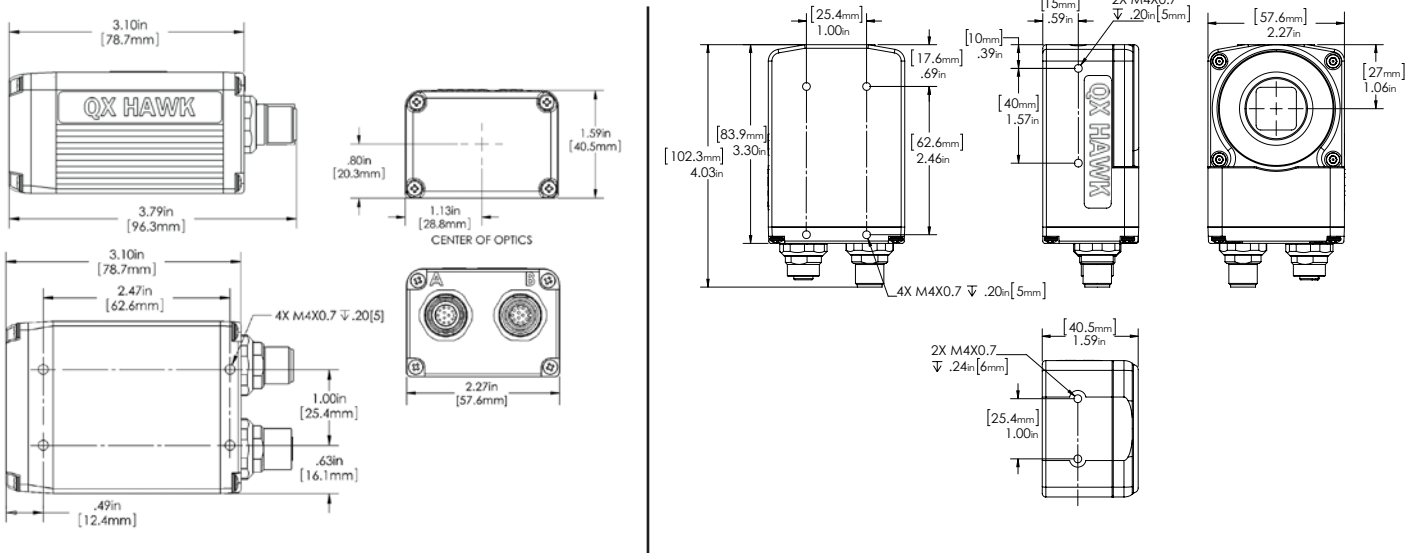

NOTE: Nominal dimensions shown. Typical tolerances apply. For Integrated Optics Model Read Range charts and information, see Page 3.

MECHANICAL (INTEGRATED OPTICS)

Height: 1.59" (40.5 mm)
Width: 2.27" (57.6 mm)
Depth: 3.79" (96.3 mm)
Weight: 10 oz. (280 g)

MECHANICAL (C-MOUNT OPTICS)

Height: 4.03" (102.3 mm)
Width: 2.27" (57.6 mm)
Depth: 1.59" (40.5 mm)
Weight: 11 oz. (320 g)

ENVIRONMENTAL

Enclosure: Die-cast aluminum, IP65/67 rated
CMOS Operating Temperature: 0° to 50° C (32° to 122° F)
CCD Operating Temperature: 0° to 45° C (32° to 113° F)
Storage Temperature: -29° to 70° C (-20° to 158° F)
Humidity: Up to 90% (non-condensing)

COMMUNICATION INTERFACE

Interface: RS-232/422/485 or Ethernet

CE MARK

General Immunity for Light Industry:
 EN 55024: 1998 ITE Immunity Standard
Radiated and Conducted Emissions of ITE Equipment: EN 55022:98 ITE Disturbances

LIGHT SOURCE (INTEGRATED OPTICS)

Type: High output LEDs



SYMBOLOLOGIES

2D Symbolologies: Data Matrix (ECC 0-200), QR Code, Micro QR Code, Aztec Code
Stacked Symbolologies: PDF417, Micro PDF417, GS1 Databar (Composite & Stacked)
Linear Barcodes: Code 39, Code 128, BC 412, I2 of 5, UPC/EAN, Codabar, Code 93, Pharmacode, PLANET, PostNet, Japanese Post, Australian Post, Royal Mail, Intelligent Mail, KIX

LIGHT COLLECTION OPTIONS

Progressive scan, square pixel.
Shutter: Software adjustable 10 µs to 1/60 second
Sensor: 1/3 inch
WVGA: CMOS, 752 by 480 pixels, up to 60 fps
SXGA: CCD, 1280 by 960 pixels, up to 20 fps

PIN ASSIGNMENTS

CONNECTOR A M12 12-pin plug:

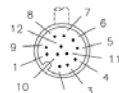

Pin Assignment

9	Host RxD
10	Host TxD
2	Power
7	Ground
1	Trigger
8	Input Common
3	Default
4	New Master
5	Output 1
11	Output 2
6	Output 3
12	Output Common

CONNECTOR B M12 12-pin socket:

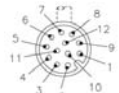

Pin Assignment

9	TxD/RTS
10	RxD/CTS
2	Power
7	Ground
1	Trigger
8	Input Common
3	Terminated
4	Input 1
5	422/485 TxD (+)
11	422/485 TxD (-)
6	422/485 RxD (+)
12	422/485 RxD (-)

ETHERNET CONFIGURATION CONNECTOR B M12 8-pin socket:



Pin Assignment

1	Terminated
2	Terminated
3	Terminated
4	TX (-)
5	RX (+)
6	TX (+)
7	Terminated
8	RX (-)

INDICATORS

LEDs: Read Performance, Power, Read Status, Network activity, I/O **Beeper:** Good read, match/mismatch, noread, serial command confirmation, on/off

INTEGRATED OPTICS MODEL ONLY:

Green Flash: Good read **Red X:** Symbol locator

READ PARAMETERS

Pitch: ±30° **Skew:** ±30° **Tilt:** 360°
CMOS Decode Rate: Up to 60 decodes per second
CCD Decode Rate: Up to 20 decodes per second

LASER LIGHT (INTEGRATED OPTICS)

Type: Laser diode
Output Wavelength: 655 nm nominal
Operating Life: 50,000 hours @ 25° C
Safety Class: Visible laser: Class 1

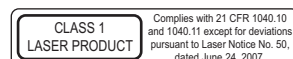

PROTOCOLS

Point-to-Point, Point-to-Point w/RTS/CTS, Point-to-Point w/XON/XOFF, Point-to-Point w/RTS/CTS & XON/XOFF, Multidrop, Daisy Chain, User-Defined Multidrop, Ethernet TCP/IP, EtherNet/IP

ELECTRICAL

CMOS Power Requirement: 5-28 VDC, 200 mV p-p max ripple, 135 mA at 24 VDC (typ.)
CCD Power Requirement: 5-28 VDC, 200 mV p-p max ripple, 170 mA at 24 VDC (typ.)

DISCRETE I/O

Input 1/Trigger/New Master: Bi-directional, optoisolated, 4.5–28V rated, (13 mA at 24 VDC)
Outputs (1, 2 & 3): Bi-directional, optoisolated, 1–28V rated, (I_{CE} <100 mA at 24 VDC, current limited by user)

SAFETY CERTIFICATIONS

CDRH, FCC, UL/cUL, CE, CB, BSMI (compliant)

ROHS/WEEE COMPLIANT

ISO CERTIFICATION

Certified ISO 9001:2008 Quality Management System

©2017 Microscan Systems, Inc. SP064JFR-0417

Read Range and other performance data is determined using high quality Grade A symbols per ISO/IEC 15415 and ISO/IEC 15416 in a 25° C environment. For application-specific Read Range results, testing should be performed with symbols used in the actual application. Microscan Applications Engineering is available to assist with evaluations. Results may vary depending on symbol quality. **Warranty**—For current warranty information on this product, please visit www.microscan.com/warranty.

MICROSCAN®

Microscan Systems Inc.

Tél. 425 226 5700 / 800 251 7711

Fax 425 226 8250

Microscan Europe

Tél. 31 172 423360 / Fax 31 172 423366

Microscan Asia Pacific

Tél. 65 6846 1214 / Fax 65 6846 4641

www.microscan.com

Informations produit : info@microscan.com

Support technique : helpdesk@microscan.com

QX HAWK FLEXIBLE, INDUSTRIAL IMAGER

SPECIFICATIONS AND OPTIONS

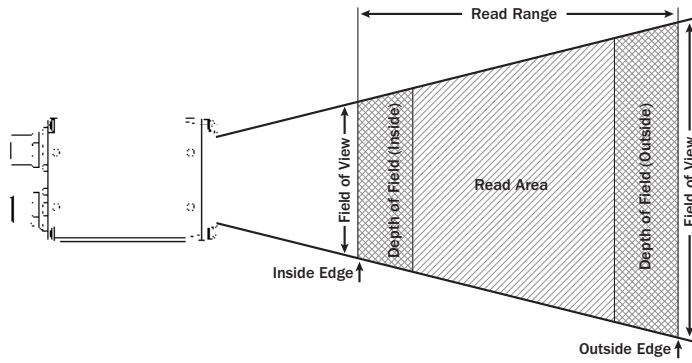



INTEGRATED OPTICS MODEL: CMOS MODULAR ZOOM OPTICS

Inches (mm)

12°	Narrow-bar-width		Read Range (using autofocus)	Field of View		Depth of Field	
	1D	2D		Inside Edge	Outside Edge	Inside Edge	Outside Edge
	0.0033 (0.08)	0.005 (0.13)	3.4 to 6 (86 to 152)	0.9 (23)	1.42 (36)	0.2 (5)	0.4 (10)
	0.0075 (0.19)	0.010 (0.25)	3.3 to 12.2 (83 to 310)	0.9 (23)	2.62 (66)	0.4 (10)	1.5 (38)
	0.0150 (0.38)	0.020 (0.51)	3.3 to 13 (82 to 330)	0.9 (23)	2.77 (70)	0.5 (13)	3.5 (89)
	0.0350 (0.89)	0.050 (1.27)	4 to 16 (101 to 406)	1.03 (26)	3.34 (85)	0.7 (18)	6.5 (165)

15°	Narrow-bar-width		Read Range (using autofocus)	Field of View		Depth of Field	
	1D	2D		At Inside Edge	At Outside Edge	Inside Edge	Outside Edge
	0.0033 (0.08)	0.005 (0.13)	1.9 to 5 (48 to 127)	0.75 (19)	1.53 (39)	0.3 (6)	0.4 (10)
	0.0075 (0.19)	0.010 (0.25)	1.8 to 8 (46 to 203)	0.72 (18)	2.28 (58)	0.4 (10)	1 (25)
	0.0150 (0.38)	0.020 (0.51)	1.75 to 9 (44 to 229)	0.72 (18)	2.52 (64)	0.5 (13)	3 (76)
	0.0350 (0.89)	0.050 (1.27)	3 to 10.8 (76 to 274)	1.03 (26)	2.96 (75)	0.6 (15)	4 (101)

30°	Narrow-bar-width		Read Range (using autofocus)	Field of View		Depth of Field	
	1D	2D		Inside Edge	Outside Edge	Inside Edge	Outside Edge
	0.0033 (0.08)	0.005 (0.13)	1 to 3 (25 to 76)	0.83 (21)	1.8 (46)	0.4 (10)	0.8 (20)
	0.0075 (0.19)	0.010 (0.25)	1 to 6.5 (25 to 165)	0.83 (21)	3.5 (89)	0.8 (20)	1.8 (46)
	0.0150 (0.38)	0.020 (0.51)	1 to 16 (25 to 406)	0.83 (21)	8.3 (211)	2 (51)	8.5 (216)
	0.0350 (0.89)	0.050 (1.27)	2 to 32 (51 to 813)	1.3 (33)	16.4 (417)	3 (76)	21.5 (546)

45°	Narrow-bar-width		Read Range (using autofocus)	Field of View		Depth of Field	
	1D	2D		Inside Edge	Outside Edge	Inside Edge	Outside Edge
	0.0075 (0.19)	0.010 (0.25)	1 to 5 (25 to 127)	1.3 (33)	4.1 (104)	1.5 (38)	2 (51)
	0.0150 (0.38)	0.020 (0.51)	1 to 9.5 (25 to 241)	1.3 (33)	7.5 (191)	2 (51)	6 (152)
	0.0350 (0.89)	0.050 (1.27)	1 to 23.5 (25 to 597)	1.3 (33)	18.3 (465)	3.8 (97)	19 (483)

NOTE: Read ranges are for specific element sizes as listed in the tables.

INTEGRATED OPTICS MODEL: CCD MODULAR ZOOM OPTICS

Inches (mm)

12°	Narrow-bar-width		Read Range (using autofocus)	Field of View		Depth of Field	
	1D	2D		Inside Edge	Outside Edge	Inside Edge	Outside Edge
	0.002 (0.05)	0.0033 (0.08)	3.5 to 7 (87 to 178)	0.9 (23)	1.62 (41)	0.1 (3)	0.3 (8)
	0.005 (0.13)	0.0075 (0.19)	3.4 to 12 (86 to 304)	0.9 (23)	2.62 (66)	0.2 (5)	1 (25)
	0.010 (0.25)	0.0150 (0.38)	3.3 to 13 (83 to 330)	0.9 (23)	2.77 (70)	0.4 (10)	2.5 (64)
	0.020 (0.51)	0.0300 (0.76)	4 to 14 (101 to 355)	1.03 (26)	2.96 (75)	0.6 (15)	5 (127)

15°	Narrow-bar-width		Read Range (using autofocus)	Field of View		Depth of Field	
	1D	2D		At Inside Edge	At Outside Edge	Inside Edge	Outside Edge
	0.002 (0.05)	0.0033 (0.08)	2 to 5 (51 to 127)	0.78 (20)	1.53 (39)	0.2 (5)	0.4 (10)
	0.005 (0.13)	0.0075 (0.19)	1.9 to 8.3 (48 to 210)	0.75 (19)	2.35 (60)	0.3 (8)	1 (25)
	0.010 (0.25)	0.0150 (0.38)	1.9 to 9.5 (47 to 241)	0.75 (19)	2.65 (67)	0.5 (13)	3 (76)
	0.020 (0.51)	0.0300 (0.76)	3 to 10.3 (76 to 261)	1.03 (26)	2.84 (72)	0.6 (15)	4.5 (114)

30°	Narrow-bar-width		Read Range (using autofocus)	Field of View		Depth of Field	
	1D	2D		Inside Edge	Outside Edge	Inside Edge	Outside Edge
	0.002 (0.05)	0.0033 (0.08)	1 to 3 (25 to 76)	0.83 (21)	1.8 (46)	0.4 (10)	0.8 (20)
	0.005 (0.13)	0.0075 (0.19)	1 to 6.5 (25 to 165)	0.83 (21)	3.5 (89)	0.8 (20)	1.8 (46)
	0.010 (0.25)	0.0150 (0.38)	1 to 16 (25 to 406)	0.83 (21)	8.3 (211)	2 (51)	8.5 (216)
	0.020 (0.51)	0.0300 (0.76)	2 to 32 (51 to 813)	1.3 (33)	16.4 (417)	3 (76)	21.5 (546)

45°	Narrow-bar-width		Read Range (using autofocus)	Field of View		Depth of Field	
	1D	2D		Inside Edge	Outside Edge	Inside Edge	Outside Edge
	0.005 (0.13)	0.0075 (0.19)	1 to 5 (25 to 127)	1.3 (33)	4.1 (104)	1.5 (38)	2 (51)
	0.010 (0.25)	0.0150 (0.38)	1 to 9.5 (25 to 241)	1.3 (33)	7.5 (191)	2 (51)	6 (152)
	0.020 (0.51)	0.0300 (0.76)	1 to 23.5 (25 to 597)	1.3 (33)	18.3 (465)	3.8 (97)	19 (483)

NOTE: Read ranges are for specific element sizes as listed in the tables.

MICROSCAN®