

GENERAL CATALOGUE

DESIGN AND MANUFACTURE OF
ACCESS CONTROL SYSTEMS

9TH EDITION

WELCOME TO OUR UNIQUE PRODUCT RANGE!

This catalogue shows what WBH can do; a unique selection of hardware products which also illustrates our entire philosophy of doing business.

Each item, at some time or other, has been designed to solve a problem, sometimes brought to us by a customer and on other occasions anticipated by ourselves so that when the need becomes apparent we are already prepared to offer the optimum hardware solution.

We are a manufacturing company that provides purpose-designed products for the whole area of access control. We specialise in concepts for locking and latching systems, ideas which have already been translated into an immense range of fully-proven hardware, readily available at short notice and usually without batch-quantity or tooling requirements.

Our orientation is towards specialist areas which need rather more than 'commodity' products. We supply the motor industry (in the broadest possible sense), including off-road and specialist vehicles, and to world-class companies building large units such as compressors, generators, and all other types of capital plant. At another level our products are used for electrical enclosures, industrial doors and in the construction industry. And of course we operate internationally, with distributors in most developed economies.

WBH has become one of the world's premier hardware companies in terms of product range, quality, and customer support. Almost every item in this catalogue is manufactured from our own proprietary tooling, in our own factories, giving us unparalleled ability to modify, adapt or develop a product to meet your exact requirements.

Established in 1984, WBH continues the world-famous 'Wilmot Breeden' manufacturing activity. The company is now part of Metalrax Group plc.

Our unique key design will 'customise' our locking products, with your name in a logo disc, with large-size moulded head and corrosion-resistant key blades (Intro, IV).

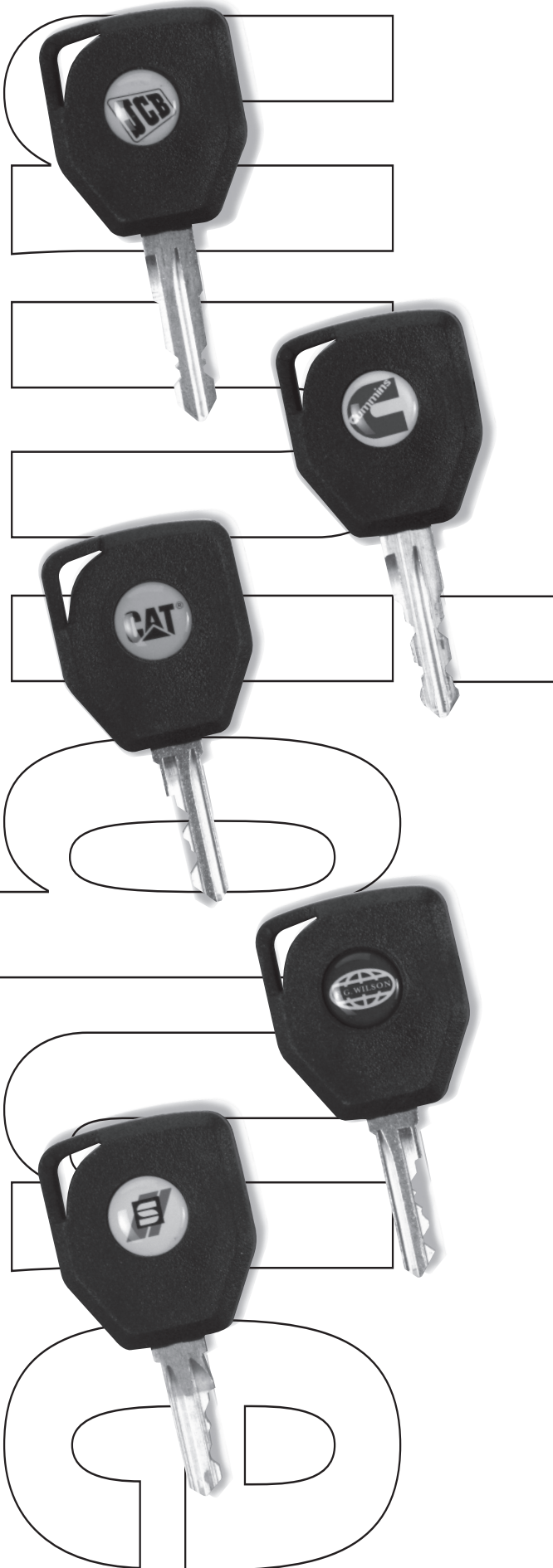

VISUAL INDEX

Products are arranged into eight groups, as illustrated. Or use the Product Finder (overpage), with part-number index at rear of the catalogue.



A **LOCKS**



B **EXTERIOR HANDLES**



C **LATCHING SYSTEMS**

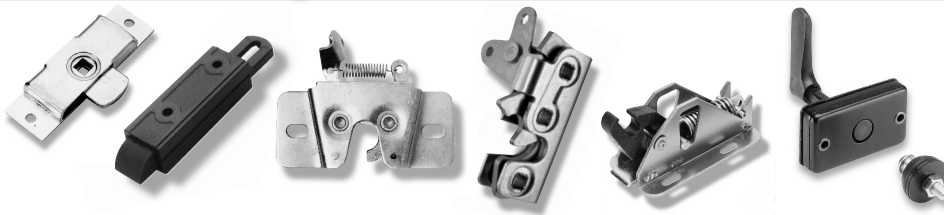

D **LATCHES & CATCHES**

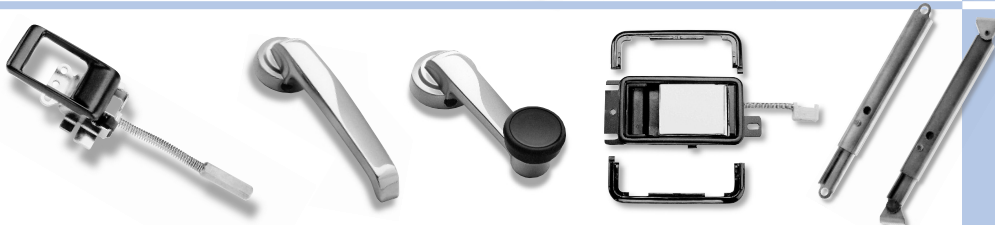

E **INSIDE CONTROLS**



F **SPECIALITY HINGES**



G **GRABS & TRIM ITEMS**



H **ASSOCIATED HARDWARE**

PRODUCT FINDER (subject index)

Ashtrays	G12
Alignment plate & pin	D30
Anti-burst latches	D18-22
Armrest	G4
'Block' hinges	F11-14
Boot/bonnet hinges	F9
'Buckle' inside release	E1
Budget latches	D1-6
'Butterfly' ignition lock	A17
Cam-form latch bars	A14, B22
Carriage keys	D2
Caulking cams	B22
Centre mechanisms	C32-34
'Chest' handles	G15
'Claw' latches	D15-17
Coat hooks	G4
Cold-store latch	C38
Column locks	A18
'Compact' handles	A11
Compartment locks	A1-8
Compression latch	C21-22
Compression locks	A1-2
Connecting rod	E2
Cubby-box locks	A15
Deadbolt systems	C34-37
Decking brackets	H8
'Deep-dish' paddles	C13-19
Desk lock	A15
Diecast cams	B22
Diecast hinges	Section F
Diecast paddles	C5
'Disc' latches	D20-21
Door buffer assembly	D27
Door hold-backs	D23-26
Door 'private' locks	A9
Draw-latches	D28-29
Drink holder	G5
Drop-T (series)	C23-30
Dust covers	A3, C29
Emergency stop-switch	H6
End-bolts	D7-10
Engine cover latches	D27-29
Equilateral recess handles	B4
Escutcheon covers	D1-3
Filler caps	H1-5
Filler neck-ends	H2,4
Finger-pulls	A3
Fixed-key fastener	A7
'Flap' handles	B28
'Flush case' inside releases	E2-3
Flush outside handles	B28

Flush-fit grab handles	G13-14
Foamed grab rails	G1-3
'French' hinge	F9
Grab handles, diecast	G10, 11, 16
Grab handles, moulded	G6-9
Grab rails, steel cored	G1-3, 6-7
Handhold, steel cored	G3
Hanging-strap handle	G5
'Heavy-duty' handles	B14-17
Heavy-T handles	B16
Hinges, lift-off	F1-6
Hinges, moulded	F1, F5
Hold-backs	D23-26
Hold-down catch	D27
Hook-latch paddles	Section C
Hook-latch, remote operated	D26
Hooked budget latches	D6
Ignition lock barrels	A17
Ignition switches	A17
Inside handles	E6-8
Inside door releases	E1-5
Keys - customised	Intro IV
Lashing ring	H8
Latch bars, comp. locks	A10
Latch bars, handles	A14, B22
L-handles, easy fix	B4
L-handles, surface mount	B5
'Lift-up' handle	G15
Linkage clips	E4
Locking filler caps	H1-4
'Lowline' handles	B11
Mini slam handles	D14
'Model 21' latch	C21-22
Moulded budget latches	D1
Moulded hinges	F1, F5
Moulded slam latches	D7
'Oval' paddle latches	C1,2
Over-centre catches	D28-29
'Paddle' latches	Section C
Paddles, 'deep dish'	C13-19
Paddles, reverse-flap	C15
Paddles, rotary latching	C10
Paddles, 2-way action	C11, C17
Padlockable handles	B12
Padlockable latches	C4, C 16, C26
'Plant-on' handles	B9-10
'Private' door locks	A9
'PSV' special handles	B8
Pull handles, locking	B30
Push-button handles	B23, 27
Push-button locks	A15-16

Quarter-turn fasteners	A7-8
Recess grab handles	G13-14
Recess-T handles	B3
Remote controls	E1-5
Rod latches	C34-37
Rotary ventilator	H7
'Security' budget latch	D4
Semi-flush 'pull' handle	B30
Semi-flush recess latch	C20
'Series 400' latches	D18
Sill-button	E1
Slam latches	D7-14
Slam systems	C31-33
Spring bolt	D6
Spring-loaded escutcheon	E8
Square-drive locks	A2, 7
Stainless 'block' hinges	F14
Stainless budget latch	D2
Stainless grab handles	G15
Stainless hinges	F3-8
Stainless steel handles	B12, 13
Stays, mechanical	E11-14
Steering column locks	A -18
Striker plates	D30
Support stays	E10-13
Surface-mount latch	C38
Switch, emergency-stop	H6
Switches, ignition	A17
T-handles, easy fix	B1-3
T-handles, surface-mount	B6, 7
Tie-down ring	H8
Titan handles (series)	B14-15
Tool-operated locks	A7, 8
'Torpedo' diecast hinges	F6
Traditional locking handles	B17-21
Tractor latch	D19
Tri-locks	A7
Turnbutton locks	A12, 13
Valves, vacuum-relief	H5
Vehicle door locks	A9
Ventilator, rotary	H7
'Waterproof' paddles	C3-4
'Weathershield' handles	B16
'Weathershield' locks	A6
Window-lift handles	E9
Window hinge	F10
Window regulators	F10

**'ONE-KEY'
SYSTEMS -
MATCHED SETS**

WBH can provide 'matched-sets' of products, all accepting the same key number ('FS' or double-sided 'FT' series), with 'customised' keys bearing an identifying logo-disc.

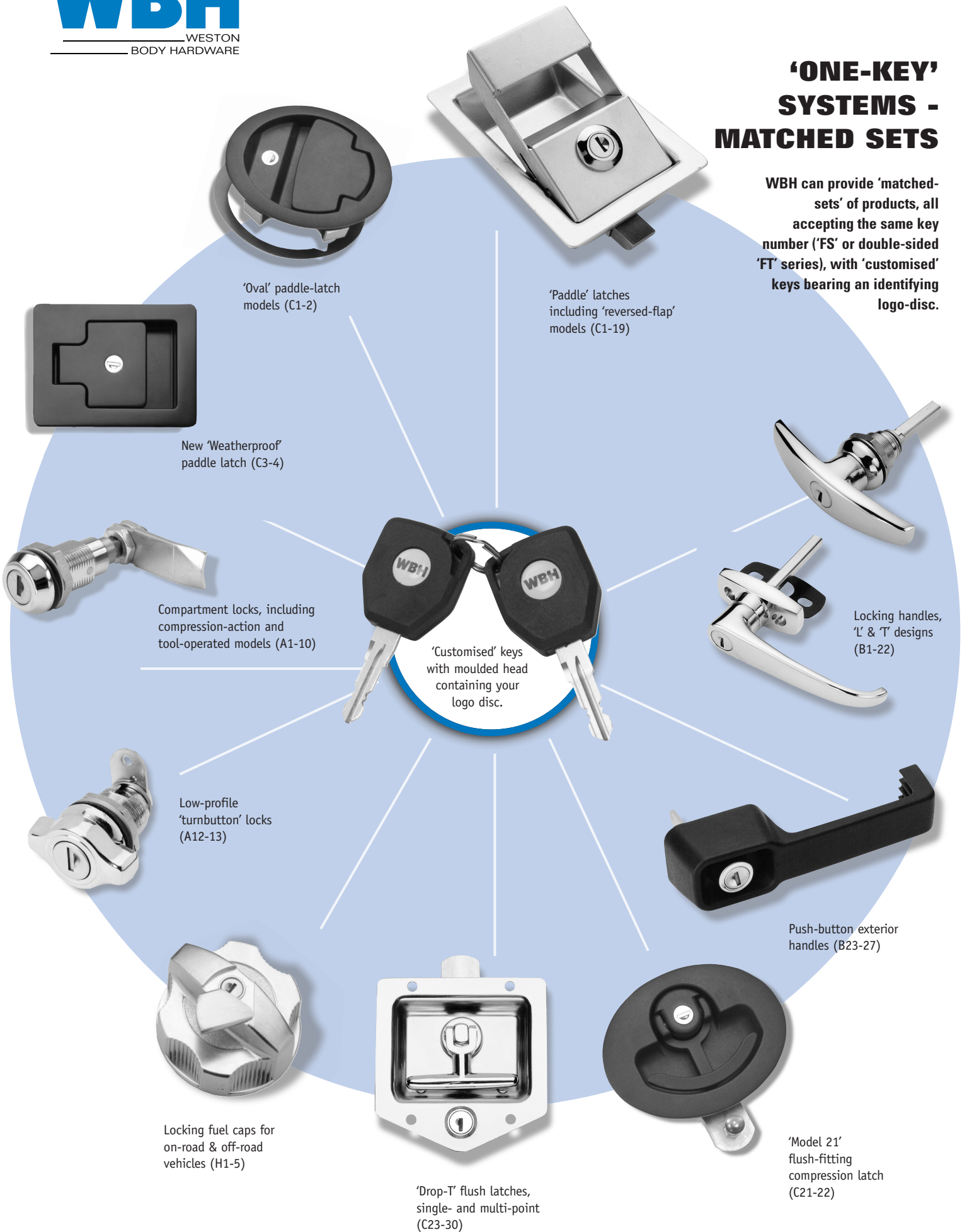

'Oval' paddle-latch models (C1-2)

'Paddle' latches including 'reversed-flap' models (C1-19)

New 'Weatherproof' paddle latch (C3-4)

Compartment locks, including compression-action and tool-operated models (A1-10)

Low-profile 'turnbutton' locks (A12-13)

Locking fuel caps for on-road & off-road vehicles (H1-5)

'Customised' keys with moulded head containing your logo disc.

'Drop-T' flush latches, single- and multi-point (C23-30)

Locking handles, 'L' & 'T' designs (B1-22)

Push-button exterior handles (B23-27)

'Model 21' flush-fitting compression latch (C21-22)

LOCK & KEY SPECIFICATIONS

Most WBH locking products use the 'disc' or 'wafer' type of lock cylinder, based on zinc-diecast bodies of 12.5 mm diameter, with 5 brass tumblers. Several lock series are available, as illustrated here, and we can also match competitors key types ('92', 'Ronis', 'DLP', and some Japanese and American series).

Keys are normally steel, fluted, cut, stamped and barrelled before nickel-plating to 5 microns thickness. This ensures smooth operation with no sharp edges and good wear-resistance.

Lock products are made as 'mixed differs' (typically, 20 different key numbers per 100 units) or 'keyed-alike', using a single, common key number. To special order locks can be built in pairs, sets etc. Spare keys or 'blanks' are readily available.

PIN-TUMBLER LOCKS

Special types of lock use machined brass pin-tumbler mechanisms, which allows greater security and increased corrosion-resistance.

'CUSTOMISED' KEY-HEADS

Where substantial volumes are involved, a customer's name or symbol can be 'coined' onto a steel key, or created as a coloured 'logo disc' within our large-size moulded key-heads. This can be done with any of our key series.



'FS' Hexagon-bow standard key shape



'FS' key with coined logo

'FS' Key Series

These distinctive 'hexagon'-headed keys are cut on one side only ('single-entry'), and fluted on both faces so that cylinders resist screwdriver entry. The range has 80 combinations ('differs') from FS 876-955, which can be extended to 180, maximum. This is our standard series for handles and small locks and cannot be master-keyed. Keys can be 'coined' with a logo when volume is sufficient.



'FT' coffin-bow standard key shape

'FT' Key Series

'Coffin'-headed 'FT' keys are cut on both sides ('double-entry') for greater convenience. The range has 75 combinations ('differs') which can be extended to 180, maximum, in range FT101-225. This series is used for our more recent product designs and cannot be master-keyed.



Standard 'S' series keys

'S' KEY SERIES

A double-entry series used mostly in locking filler caps. It is similar to 'FT' but has different fluting and seven 'cuts', allowing up to 500 'differs'. It is used with special lock cylinders having larger-sized tumblers, thus achieving higher levels of security for automotive applications.



Asymmetric moulded head

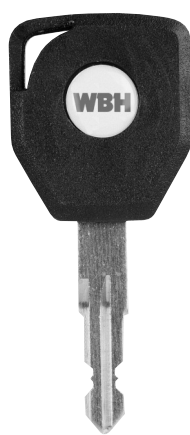

'Large-size' moulded head with logo-disc

MOULDED KEY-HEADS WITH NICKEL-SILVER BLADES

As an option, both 'FS' & 'FT' keys can be supplied with nickel-silver blades for complete corrosion resistance. These keys use moulded heads, in two styles as shown, with key number stamped on joining 'strap' or on separate stainless steel 'tally'.

The larger key-head contains a circular recess which accepts a logo disc for a fully-customised product. An illuminated key-head of same size is also available.



Door-hinge for the JCB backhoe excavator, made in composite materials and incorporating an investment-cast base-plate for welding onto door-frame. The complete hinge is over 300mm in total width and is an example of the structures which can be made in high-strength moulded materials.



Emergency-escape systems for buses and coaches, manufactured for Percy Lane Products. Note: some versions are available for general sale, subject to contract conditions.



Complete lock-set for London Taxis International, makers of the world-famous "black cab." The set uses the patented 'CAPS' high-security key system, which is available for incorporation into other locking products.

'CONTRACT' DESIGNS TO CUSTOMER SPECIFICATION

With 3D-design capability, WBH can create entirely new conceptual designs on a 'contract basis' if volumes are significant. The products are exclusive to the customer, with full tooling costs being charged. Some recent projects are illustrated here.



Proven ability to design and manufacture latches and operating systems to meet most demanding specifications.



Locks are manufactured using advanced casting technology, with large number of designs already available. Ability to create new variants, including 'matching' of other key types and expertise in pin-tumbler assembly for higher- security applications.



In-house polishing to the highest standards and expertise in plating, powder-coating, and other finishing methods.



In-house pressure diecasting, machining, and pressworking operations, with extensive experience of injection moulding and 'foam' moulding techniques and all methods of welding and mechanical assembly.



WBH is approved to ISO 9001 standards and meets quality requirements of major automotive manufacturers.

FINISHING TECHNIQUES

WBH has an unrivalled reputation for the appearance and high-quality finish of its products. The following processes are operated, and we will recommend the most suitable treatment for a particular application.

Clear zinc plating: Zinc with clear chromate passivate, usually to 8 microns thickness. Gives a bright finish and moderate corrosion resistance, suitable for indoor use, and can be applied to both pressed and diecast parts.

Olive-drab: Higher-specification zinc finish, giving some 150 hours salt-spray resistance. Used for WBH lock cylinder barrels.

Corrosion-resistance can be improved by specifying an increased thickness of zinc plating (up to 50 micron), or by sealing with sodium metasilicate to achieve up to 500 hours salt-spray resistance.

Chromium plating: A technically demanding process, operated in accordance with British Standard 1224. All parts are carefully polished in-house, before plating with copper, nickel, and finally chrome. The thickness of the nickel layer (up to 25 microns) determines corrosion resistance, and can give many years' service in all-weather conditions. Our top-quality polishing methods achieve a mirror-finish on plated items (usually diecast, but also pressed-metal). Satin chrome and black chrome are special refinements of the above techniques.

Powder coating: A polyester powder is applied electrostatically, and is then thermally cured to produce a semi-gloss paint finish (pre-treatment with chromate or phosphate bath is essential for good adhesion). This gives good appearance on diecast or pressed parts, with excellent corrosion resistance for exterior applications. Generally black, but almost any colour can be matched by RAL-International colour code.

Full-gloss or textured powder coating are refinements of the above techniques.

Albufin: A decorative and wear-resistant finish in which diecastings are polished and plated with copper and nickel before dipping in a special lacquer. After thermal curing this develops a brilliant gloss, and a variety of colours can be achieved, including gold. Highly-suited to bathrooms, and top-of-range home and commercial fittings.



Plastic-coating: Nylon or PVC can be bonded to pressed-steel components; for instance grab handles.

Encapsulation: Steel or diecast components (such as latch 'claws' or key heads) are placed in a die, and a moulded material is injected to partially enclose, or 'encapsulate' the part with a tough, wear-resistant coating that improves appearance and function

'Foamed' moulding: A relatively new process in which a solid 'insert' is completely moulded-around with expanded polyurethane foam, to give a thick, resilient covering (see WBH grab rails, G1-4). The die cavity is usually etched with a textured finish, which is reproduced upon the 'skin' of the moulding. Most colours can be matched by RAL-code.

Stainless steel: Can be polished to satin or high-gloss finishes. Can also be etched and powder-coated where totally "fail-safe" surface is required.













Certificate No: FM 35684



BS EN ISO 9001: 2000

EXPLANATION OF SYMBOLS

These symbols are used throughout the catalogue to explain characteristics of each product illustrated.

-  **Features:** Special points which distinguish the WBH product from other makes.
-  **Operation:** How does the product work? What does it do?
-  **Movement:** The direction and amount of travel with handles, latches, etc.
-  **Fixing:** Method of installation and details of fitting.
-  **Key types:** With locking products, the various key series available.
-  **Finish:** Types of surface finish offered as standard.
-  **Materials:** Whether stainless or mild steel, diecast, or moulded materials.
-  **Options:** Various ways in which an item can be customised.
-  **Testing:** Details of testing carried out and performance results.
-  **Use With:** Guide to mating parts within the WBH range.
-  **Alternative to:** Noting where WBH products are equivalent to industry standards.
-  **Economy:** Where an item represents exceptionally good value for money.

1/00831-2	'Safety' T-handles	B21	1/29450-51	'Flush cases', black	E3	604006-16	Knurled caps	H3
1/04959-64	'Heavy-duty' handles	B17	1/29624	Rod only, (1100 mm)	C34	604020-3	Finger-bar caps	H3
1/05171	Inside handle	E7	1/29774-75	'Flush cases', black	E2	604037-40	'Trimlock' caps	H4
1/05459	Inside handle, raw	E8	1/29902-3	'Flush cases', chrome	E3	604122	'Chunky' n/l. cap, grey	H2
1/06280	Ignition barrel, 'FS'	A17	1/29908	'Buckle' release	E1	604130-1	Heavy-duty filler caps	H1
1/07906	Ignition barrel (shutter)	A17	1/29990	Moulded ashtray	G12	606090-581	Finger-bar caps	H3
1/07986-8	Classic handles	B24	1/30327-8	Spring-return handles	B17	616421	Diecast filler neck	H4
1/07995	Adaptor shim	E6	1/30357	Grab handle, snap-shut	G9	616900-1	Steel neck-ends	H1
1/08438	Inside handle	E6	1/31250	Plate-type latch	D17	693041	Vacuum-relief valve	H5
1/09151	Ignition barrel, 'FT'	A17	3/02858	2-way slam system	C31	693202-296	Relief valve assemblies	H5
1/09280	Ignition barrel, '92'	A17	3/030476-77	Disc latches, push-plate	D20	694035	Vacuum-relief valve	H5
1/11465	'Ribbed' handle, lkg	B17	3/09282	Budget latch – special	D2	7/01905	Locating plate, spiked	A3
1/11818	Inside handle	E6	3/09656	Universal budget latch	D2	7/03098-99	Support stays	E10
1/11908	Inside handle, 9.5 mm	E8	3/10510-11	Budget latches 'handed'	D3	7/03181	Neoprene gasket	A3
1/11930	Inside handle	E7	3/10843-44	Budget latches – special	D4	7/04008	Ashtray assembly	G12
1/12000	Inside handle	E6	3/11048	2-way slam centre	C31	7/04131-32	'Torpedo' hinges	F6
1/12700-34	'Fluted' locking handles	B20	3/12341	Diecast striker plate	D30	7/06433	Desk lock, chrome	A15
1/12950	Locking handle, 44mm	B18	3/12497	Linkage bar (915 mm)	C32	7/08996	'Weathershield' locks	A6
1/13400	Locking 'T', 44mm	B18	3/12506-8	2/3-way centres	C32	7/09280	Cubby lock, plain	A15
1/13482	Locking 'T', 38mm	B18	3/13520-1	Alignment plate/pin	D30	7/09302-3	Cubby locks	A15
1/13700	'Small L' handles, lkg	B19	3/14422	Trim bezel, black	E2	7/10015-16	'Torpedo' hinges	F6
1/14300-600	'Arched' handles	B19	3/14493	Connector block	E3	7/10668-9	Diecast grab handles	G11
1/15100-34	'Fluted' plain handles	B20	3/15610-11	'Flush cases', chrome	E2	7/22931-2	Comp. locks, 13mm	A4
1/15400-2	Non-locking 'T' handles	B18	3/16200-1	Budget latches - hooked	D6	7/23057	Finger-pull, chrome	A15
1/16100-31	'Straight T' handles	B20	3/17330-32	'Utility' slam latches	D13	7/24385	Spring fixing clip	A9
1/16420	Spring-escutcheon	E8	3/18238-54	3-way rod latches	C36	7/25122	Support stays - small	E12
1/16600-86	Non-locking handles	B18	3/18341-4	2/3-way systems	C33	7/25250	Comp. locks - special	A5
1/18140	'Small L' handles, plain	B19	3/18617	Guide for slam systems	C33	7/25621	Support stays	E11
1/18259	'Ribbed' handle, plain	B17	3/18702	Rod only, (1145 mm)	C32	7/26596	Support stays - small	E11
1/20550	Traditional grab handle	G16	3/18716	Rod guides (3-way)	C36	7/26668	Sill-button	E1
1/20574	Lowline grab handle	G16	3/18722	'Keeper' plate (3-way)	C36	7/27693	'Butterfly' ignit. barrel	A17
1/22788-9	Push-button handles	B24	3/18794-95	2-way rod latches	C35	7/27900	Escutcheon cover 2-hole	D2
1/23805-6	'Mini' Push-button hdl's	B26	3/18898-9	Rod guides (2-way)	C35	7/28362-4	Diecast 'C' handles	G16
1/24188	Inside handle, chrome	E8	3/21330	Loop-striker	D20	7/28745-6	Diecast grab handle	G10
1/24212	Inside handle	E6	3/21787	Moulded 'buffer'	D16	7/35270	Ashtray, plant-in	G12
1/24214	Window handle	E6	3/22142-43	'Disc' latches, 'Mini'	D20	7/35310	'Coin-op' lock, 19mm	A8
1/24425	Window handle	E9	3/22324	Escutcheon bowl	E1	7/35442	Diecast cabinet handle	G10
1/24466-68	'Limo' handles	B25	3/22386-92	End latches	D9	7/35838-43	Support stays	E11
1/24497	Plant-on 'L' RH Lkg	B10	3/22510-13	'Mini' slam latches	D14	7/35864	Support stay	E12
1/24507	Plant-on 'T' LH Lkg	B10	3/30476-7	Disc latches RH/LH	D20	9/00006	Support stays	E10
1/24517	Plant-on 'T' RH Lkg	B10	5/00097	Cam-form latch bar	A14	9/00028	Pull-handle latch	D11
1/24596-7	'T'-keys	D2	5/00275-6	Cam-form latch bars	A14	9/00034	Boot/bonnet hinges	F8
1/24799-809	Plant-on 'L' handles	B10	5/00479	Locating plate, flat	A3	9/00048	'French' hinge	F8
1/24819-29	Plant-on 'T' handles	B10	5/00508/789	Two-point bars	A14	9/00051	8 mm steel shaft	E7
1/24854	Plant-on 'L' LH Lkg	B10	5/00939	Gasket for recess pan	B3	9/00066	Finger-pull, steel	A3
1/25515-7	'Lowline' handles	B11	5/01389	Two-point bar, 46mm	A14	9/00078	Connector rod, 1-metre	E2
1/25653-73	'Flap' handles	B28	5/01464-5	Striker & escutcheon	A20	9/00088-89	Budget latch - security	D4
1/26379-90	Block hinges - small	F12	5/01595	Moulded spacer ring	A3	9/00103-7	Comp. locks, 19mm	A4
1/26391-3	Block hinges – 'Mini'	F12	5/01664	Moulded handles	E7	9/00112-3	'Tri-locks'	A7
1/26649-50	'Washboard' releases	E4	5/01911	Two-point bar, 32mm	A14	9/00114	Compression lock, tool-	A2
1/26750	Block hinges - medium	F13	5/02067-71	Latch bars – heavy duty	B22	9/00123	'Fixed-key' locks	A7
1/26808-9	'Torpedo' hinges, raw	F6	5/02090	Ignition switch only	A17	9/00129	Key for 'Tri-locks'	A7
1/26869-70	Linkage clip, large	E4	5/02136	Deep bezel for switch	A17	9/00138	Recess pan, black	B3
1/26915	Block hinges - medium	F13	5/02706,21	Cam-form latch bars	A14	9/00140-3	'Small T' handles	B6
1/27106-13	Diecast striker plates	D30	515544-7	Steering locks, 'in-line'	A18	9/00144-7	'Large T' handles	B7
1/27251-2	'Safety' L-handles	B21	515570-95	Steering locks,	A18	9/00156	Equilateral recess sets	B4
1/27296-7	Diecast cams, 32mm	B22	600281-296	'Chunky' caps,	H2	9/00160	Escutcheon cover 3-hole	D3
1/27847	Retaining nut, brass	A3	601576	Castellated cap	H5	9/00163-166	Stainless grab rails	G15
1/27890-902	Compartment locks	A3	602691	Castellated cap,	H5	9/00167-183	Lever 'L' handles	B5
1/28892	Locking handle, 38mm	B18	602888	'Chunky' lkg. cap, grey	H2	9/00184-6	Recess 'T' sets	B3
1/28902-3	'Arched' handles 38mm	B19	602935-6	'Chunky' filler caps	H2	9/00210-12	'Sports' handles	B25
1/29344-6	'Flap' handles	B28	603246	Ratchet cap assembly	H5	9/00214/224	Diecast grab-rails	G11
1/29371	Ashtray, plant-in	G12	604001	Knurled cap, black	H3	9/00225	Window handle	E9
1/29400-1	'Private' locks	A9	604005	Finger-bar cap, grey	H3	9/00239	Inside handle	E8

9/00240-1	'Small T' handles,	B6	9/01077-78	2-way rod assembly	C37	9/01790	Grab handle, 245 mm	G8
9/00244-5	'Large T' handles	B7	9/01109-10	Recess-square locks	A8	9/01822-25	Lift-off hinges, diecast	F4
9/00260	Inside handle, chrome	E8	9/01115	Semi-flush grab handle	G14	9/01828	Outside hold-back	D26
9/00263	Claw latch & cover, RH	D16	9/01144	Drinks-holder	G5	9/01830-2	'Tractor' latches	D19
9/00279	Top-knob latch	D11	9/01145-6	Coat hooks	G4	9/01840-1	Semi-flush latch	C20
9/00283	Claw latch RH	D16	9/01177-78	2-way rod assembly	C37	9/01846-9	Surface-mount latch	C38
9/00284-85	Over-centre catches	D28	9/01181-2	Tie-down rings	H8	9/01855-7	Rotary ventilators	H7
9/00359-60	'Trail-plate' releases	E5	9/01183	Claw latch LH	D16	9/01861	'Turnbutton' locks	A12
9/00400-2	Padlockable handles	B12	9/01184-5	PSV 'L' handles	B8	9/01875	'Turnbutton' units	A13
9/00403	'High-grip' grab handle	G7	9/01186	'Fix-through' latch	D8	9/01900-1	Push-button handles	B23
9/00404-5	Grab handles, steel core	G6	9/01187	Stainless steel latch	D9	9/01902-3	'Heavy-T' handles	B16
9/00406	Loop striker, stainless	C9	9/01223-24	Rotary latches	D22	9/01907-11	Decking brackets	H8
9/00408-420	Paddles, slam (open-fix)	C6	9/01226	Grab rail, 475mm	G2	9/01914SS	Lift-up handle, stainless	G15
9/00409-417	Paddles, 2-way action	C11	9/01226	'Hand-hold', 150mm	G3	9/01930-1	Low-profile locks	A9
9/00418-420	Paddles, slam (open-fix)	C6	9/01227	Arm rest, 222mm	G4	9/01936	Diecast snap-catch	D26
9/00423-5	Series 400 latches	D18	9/01243	Top-knob latch	D11	9/01951	Holdback unit (new)	D23
9/00426	Striker plate	C10	9/01246	Pin-type striker, 23 mm	D15	9/01954-58	Rotary holdback units	D25
9/00429	Paddles, M/S, 2-way set	C11	9/01279-80	'Titan' handles 160mm	B14	9/01956-7	Moulded budget latches	D1
9/00436-439	Paddles, 2-way	C11	9/01283	Side-mount latch, RH	D15	9/01960	Moulded escutch. cover	D1
9/00440-9	Paddles, hook(open-fix)	C8	9/01289-91	Block hinges - stainless	F14	9/01966-67	Block hinges - flush	F11
9/00450-7	Diecast paddle series	C5	9/01351	Holdback unit	D24	9/01968	Door buffer assembly	D27
9/00460-71	Paddles, slam (studded)	C7	9/01369-70	PSV 'T' handles	B8	9/02000-3	Deep paddles, M/S hook	C14
9/00462-73	Paddles, hook (studded)	C7	9/01372	Slam latch. 'nose-up'	D13	9/02006-9	Deep paddles, M/S slam	C13
9/00490-3	Paddles, rotary latch	C10	9/01380-81	Lift-off hinges, moulded	F5	9/02022-23	Deep paddles, S/S hook	C14
9/00557	Support stays	E10	9/01383	Hold-down catch	D27	9/02028-29	Deep paddles, S/S slam	C13
9/00589-90	Comp. locks, 30mm	A6	9/01384	Double-loop striker	D27	9/02041	Padlockable deep-dish	C16
9/00593	'Pull' handle	B30	9/01385	'Coin-op' lock, 30mm	A8	9/02058-61	2-way slam systems	C31
9/00608	Inside handle, 8 mm	E8	9/01388	Window-pull handle	G13	9/02094-96	Heavy-duty o/centres	D29
9/00612-3	Square-drive locks	A7	9/01389/01	Flush-fit grab handle	G14	9/02142-43	'Disc' latches, 'linkage'	D21
9/00625	Window handle	E9	9/01390-1	Recess grab handles	G13	9/02238-49	Deep paddles, 2-way	C17
9/00629	Key for sq.-drive locks	A7	9/01400-01	Adjustable hinges	F3	9/02300	Compression locks, key	A1
9/00634	Boot/bonnet hinge	F8	9/01402-3	Lift-off hinges, steel	F2	9/02357	Grab handle, snap-shut	G9
9/00699-700	Window hinges	F7	9/01433	Emergency-stop pan	H6	9/02730-32	'Utility' slam latches	D13
9/00701	Diecast profile hinge	F9	9/01442-43	Lift-off hinges, stainless	F2	9/03000	'Model 21' latch	C21
9/00708	'Buckle' release	E1	9/01444-45	Concealed hinges, SS	F3	9/03419	Oval paddle, slam-bolt	C2
9/00724	Pin-type striker, 52 mm	D15	9/01454	Flat bar (1000 mm)	C34	9/03440	Oval paddle, hook-latch	C1
9/00726	T-key, 62mm length	A8	9/01455-58	Side-action latches	D10	9/04442-3	Moulded hinges	F1
9/00729	Key, 7mm square	A2	9/01463	Emergency-stop switch	H6	9/05462	Weatherproof paddles	C3
9/00749	Striker plate	D3	9/01479	Hook latch	D26	MP00502	Gasket for paddles	C12
9/00755-56	Large budget latches	D5	9/01501-4	'Drop-T', S/S, locking	C23			
9/00799	Spring bolt	D6	9/01505-6	'Drop-T', S/S. non-lkg	C24			
9/00801	Inside handle	E7	9/01511-14	'Drop-T', M/S, locking	C23			
9/00802	Inside handle	E8	9/01515-16	'Drop-T', M/S, non-lkg	C24			
9/00803-6	Slam latches	D12	9/01526	Grab handle, conc. fix	G8			
9/00828	Moulded weathershield	A3	9/01528-30	Moulded slam latches	D7			
9/00837	Diecast cam, 63mm	B22	9/01535-36	Lift-off hinges, black	F2			
9/00838-40	Block hinges - large	F13	9/01538-39	Concealed hinges, black	F3			
9/00849	'Weathershield' locks	A6	9/01542	Fixed-pin hinge, SS	F10			
9/00851-2	Special latches	D12	9/01561-64	'Drop-T', 3-way sets	C27			
9/00855-56	Budget latches - special	D5	9/01567-70	'Drop-T', 3-way centres	C27			
9/00858	Finger-pull, moulded	A3	9/01581-82	Heavy duty strikers	D22			
9/00874-75	Window handles	E9	9/01583	Side-mount latch, LH	D15			
9/00927	Comp. locks - special	A5	9/01596-97	'Washboard' releases	E4			
9/00935-7	'Compact' handles	A11	9/01605-15	Stainless steel handles	B13			
9/00960-1	Lever 'L' - Easy fix	B4	9/01621-24	'Drop-T', 2-way models	C29			
9/00975-6	'Small T' - Easy-fix	B1	9/01660-5	Plant-on 'T' handles	B9			
9/00990-1	'Large T' - Easy fix	B2	9/01667-70	Plant-on 'L' handles	B9			
9/00984	Moulded over-centre	D28	9/01701	Window handle	E9			
9/01013-14	'Flush cases', special	E3	9/01725	Grab rail, 300mm	G1			
9/01035-8	'Titan' handles 185mm	B15	9/01728-29	Single-point latches	D8			
9/01050-1	2-way centres	C34	9/01746	Hanging-strap handle	G5			
9/01059	Bottom-knob latch	D11	9/01770-71	Latch with microswitch	D17			
9/01062	'Mini' paired handles	B26	9/01779	3-way rod assembly	C37			
9/01071-2	'Titan' handles 185mm	B15	9/01780-3	Stainless profile hinges	F9			

General conditions Regarding Catalogue products

1. Illustrations are for general guidance only and you should refer to our engineering drawings before specifying critical dimensions.
2. The company reserves the right to alter and amend any specifications without prior notice, in the interests of product improvement.
3. Customers must satisfy themselves as to the suitability of our products for their particular application. No performance claims are implied unless specifically stated, and liability for defective products is restricted to free replacement or payment of an equivalent sum.

LOCKS

**SMALL LOCKS,
LOCK CYLINDERS,
IGNITION LOCKS**

**NEW
PRODUCT**



New, compression lock gives 6mm 'take-up'. Also in tool-operated versions

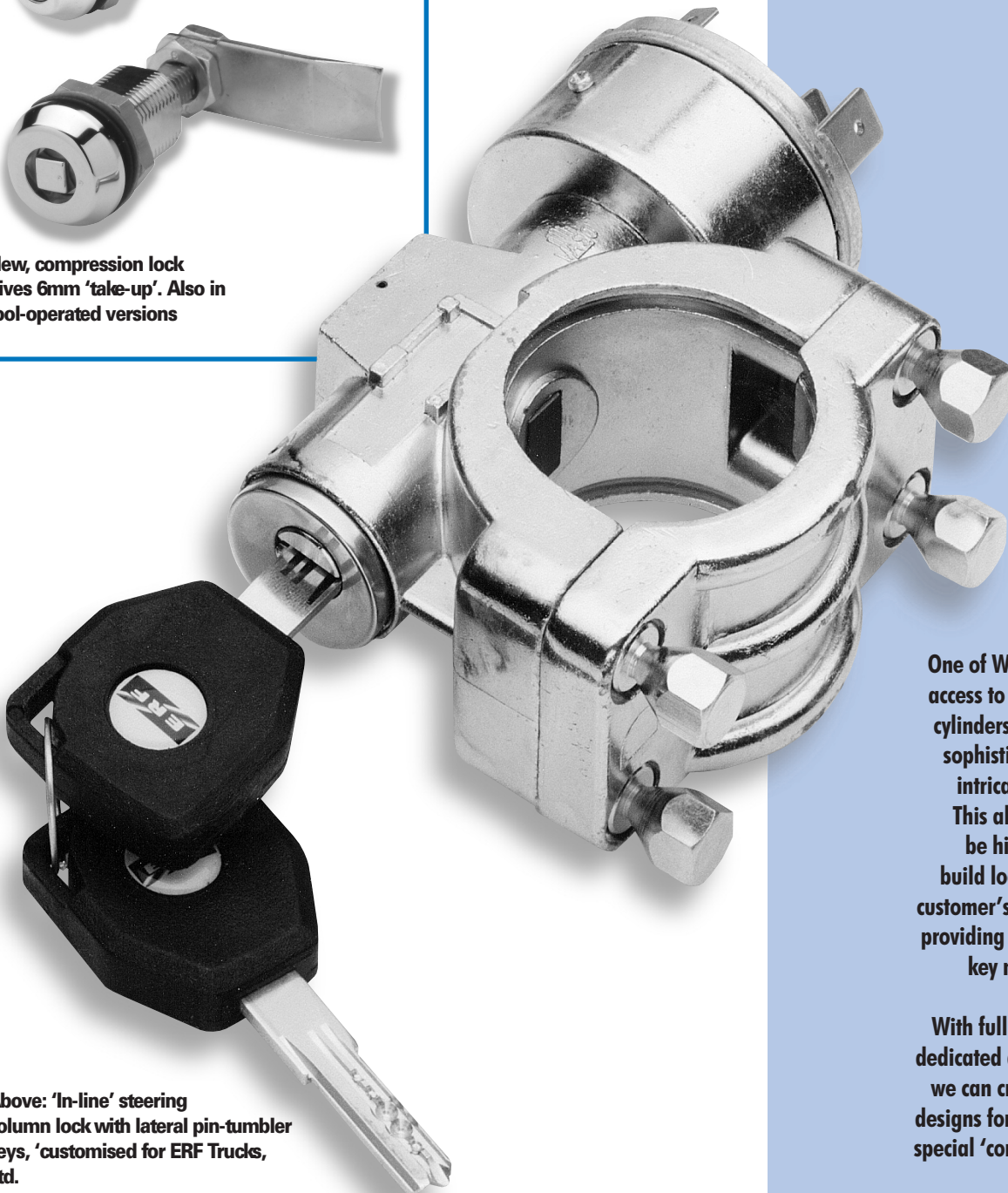

Above: 'In-line' steering column lock with lateral pin-tumbler keys, 'customised for ERF Trucks, Ltd.

One of WBH's strengths is the access to a wide range of lock cylinders, manufactured from sophisticated tooling for the intricate castings involved. This allows the company to be highly flexible, able to build locking products to the customer's exact specifications, providing lock sets and special key numbers as required.

With full design facilities and dedicated diecasting resources, we can create altogether new designs for locking products for special 'contract' requirements.

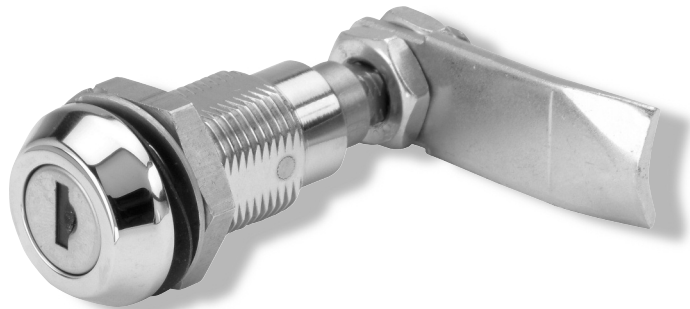

Double-sided "FT" keys only

9/02300 compression lock, with straight latch bar, shown in fully-extended ('open') position

KEY-OPERATED COMPRESSION LOCKS

A new lock design, intended for use with gasketed doors, which provides 6mm of compression to make a firm seal. It is water-resistant, fully adjustable, and is mounted within an industry-standard 4-sided panel aperture. Straight latch as standard, with a full range of other bars available.

ORDERING CODE

9/02300	Compression lock, chrome
9/02300/01	as above, FT111
9/02300B	Compression lock, black
9/02300B /01	as above, FT111

SPECIFICATION

A	Head Diameter	29 mm
B	Total Depth (locked)	70 mm
C	Head projection	8 mm
D1	Depth to latch (min)	44 mm
D2	Depth to latch (max)	55 mm
E	Body depth	40 mm
F	Engagement	47.6 mm
G	Body across flats (square)	18.8 mm
H	Body diameter	22 mm
I	"Take-up" Depth	6 mm

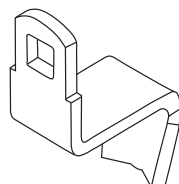
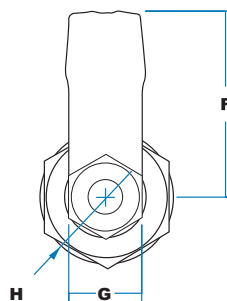
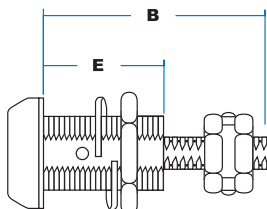
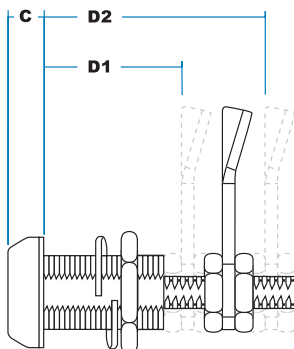

Alternative latch bars allow dimension D1 to be reduced to 14mm - See Page A14 for options available.

- Very positive engagement, water-resistant and adjustable.
- Key brings latch bar into 'closed' position, then draws-up bar by 6mm against seal.
- Key turns clockwise through 90 degrees to operate latch, then through a further quarter-turn to compress against door-edge or striker. Latch bar is adjustable through 11mm.
- Fix through industry-standard 4-sided aperture with brass nut & stainless spring-washer on threaded body, and neoprene gasket. Latch-bar secured by nut and locknut on threaded spigot.
- 'FT' keys with shuttered keyway as standard.
- Chromium-plated as standard, optionally black powder-coated.
- Alternative latch bars. Special key numbers
- WBH design covered by UK Patent Application 0224237.8
- Highly cost-effective against market alternatives.



9/00114B











Diecast key has recess for customer logo disc, and can be finished in black or other colours to special order.

9/00729

TOOL-OPERATED COMPRESSION LOCKS

A model intended for use with heavy gaskets and seals, so that when locked the latching bar is drawn up by 6mm and is held firmly in place. Water sealed, fully adjustable, and mounting to industry-standard 4-sided panel aperture. Smart diecast key with provision for customer's identity logo.

-  Very positive engagement against vibration, water-sealed and adjustable.
-  Key operates plug, bringing latch into "closed" position and then drawing up against seal.
-  Latching bar is rotated 90 degrees only, then withdraws by 6mm. Adjustment of latch through 20mm.
-  Through industry-standard 4-sided aperture, secured by brass nut & stainless spring washer on threaded body. Latch bar secured by nut and locknut on end-spigot.
-  7mm-square drive plug
-  Black or chromium-plated.
-  Other drive plugs (triangular, slotted, etc). Alternative latch bars
-  WBH design covered by UK Patent Application 0224237.8

ORDERING CODE

9/00114	Compression lock, chrome
9/00114B	Compression lock, black
9/00729	Diecast key, plain

SPECIFICATION

A	Head Diameter	29 mm
B	Total Depth (locked)	65.5 mm
C	Head projection	8 mm
D1	Depth to latch (min)	36 mm
D2	Depth to latch (max)	56.4 mm
E	Body depth	32 mm
F	Engagement	47.6 mm
G	Body across flats (square)	18.8 mm
H	Plug size	7 mm
I	"Take-up" Depth	6 mm

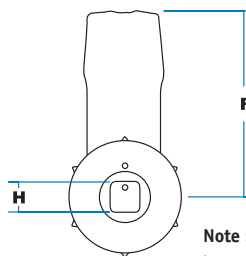
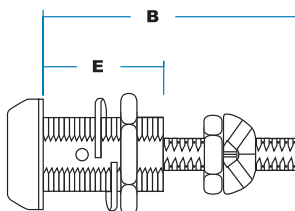
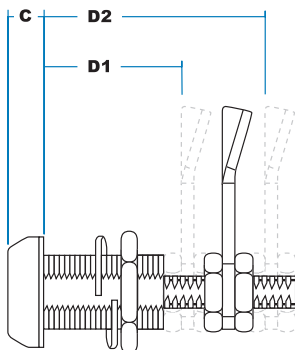
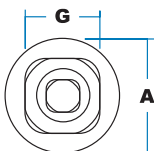

Note : Dots and latch bar to line up when in compressed position

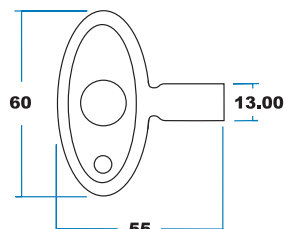



7/01905
Locating plate



1/27893

ORDERING CODE

'De-luxe' specification

1/27890	'Deluxe' lock, 90°, mixed keys
1/27893	'Deluxe' lock, 90°, FS 880
1/27900	'Deluxe' lock, 180°, mixed keys
1/27902	'Deluxe' lock, 180°, FS 880

7/01905, spiked locating plate for fitting to wooden panels

Panel-piercing detail

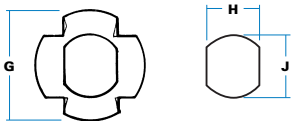

G	Diameter, locating plate	34 mm
H	Piercing, across flats	17.5 mm
J	Piercing, diameter	20 mm

Locating plate enables lock to be fitted into a round hole, especially with wooden panels. Latch bar must be removed for mounting

7/01905	Locating plate, spiked
5/00479	Locating plate, flat (steel)

9/00858
Finger-pull

Black, moulded design which improves access to cabinet door. Suits all models

SPECIFICATION

For clarity, retaining nut is not shown

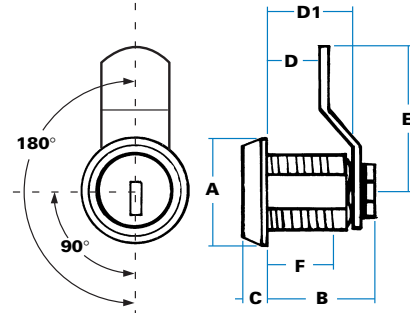

A	Head diameter	26 mm
B	Total depth	28 mm
C	Head projection	6 mm
D	Depth to cranked latch	11 mm
D1	Body depth	19 mm
E	Height of bar	37 mm
F	Thread depth	15 mm

latch bar reversible, can be fitted at 45° intervals.

1/27847	Retaining nut (brass)
7/03181	Neoprene gasket (black)

9/00066
Finger-pull

Chromium-plated, steel finger-pull for 'utility' applications.

9/00928
**Moulded
weathershield**

Black PVC cover for weather-protection. Suits all round-face locks. (Also see A6)

5/01595
Moulded spacer

Useful where inside space is limited, raises lock 5mm above panel surface. Black nylon.

COMPARTMENT LOCKS (19mm) - 'DE-LUXE' SPECIFICATION

These are simple, inexpensive locks used on all types of steel and metal enclosures, cabinets and panels. The diecast housing fits a 'double-D' piercing and is retained by a large hexagonal nut.

This is the original 'Wilmot Breedren' specification with several special features as noted. It is particularly suited for applications where vibration may be a problem.

- Hex-bolt, lockwasher and device retention clip for secure assembly, spiked locating plate and 'cranked' latch bar as standard (illustrated). Chromium-plated.
- 90° or 180° rotation as shown. Note that key does not withdraw in unlocked (9 o'clock) position with 90° models.
- 'FS' keys as standard with 'shuttered' keyway. Optionally 'FT', '92' or 'DLP' key types.
- Wide choice of latch bars, finish options and accessory items. Special key numbers or sets on request.

ACCESSORY ITEMS

Illustrated here are some useful add-on accessory items for our compartment lock range.

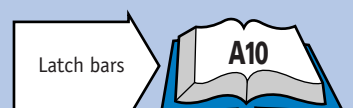



9/00103

COMPARTMENT LOCKS [19mm] STANDARD SPECIFICATION

Identical in most details to the 'deluxe' models, these locks have a simplified specification which enables them to be installed without need for dismantling latch bar.



90° or 180° rotation as shown. Note that key does not withdraw in unlocked (9 o'clock) position with 90° models.



'FS' keys as standard with 'shuttered' keyway. Optionally 'FT', '92' or 'DLP' key types.



Chromium-plated as standard: black or zinc-plated to order.



Wide choice of latch bars, finish options and accessory items. Special key numbers or sets on request.

ORDERING CODE

'Standard' specification

9/00107	Compartment lock, 90°, mixed keys
9/00103	Compartment lock, 90°, FS 880
9/00108	Compartment lock, 180°, mixed keys
9/00105	Compartment lock, 180°, FS 880

7/01905, spiked locating plate for fitting to wooden panels

Panel-piercing detail



G	Diameter, locating plate	34 mm
H	Piercing, across flats	17.5 mm
J	Piercing, diameter	20 mm

Locating plate must be ordered separately with this specification.

SPECIFICATION

For clarity, retaining nut is not shown

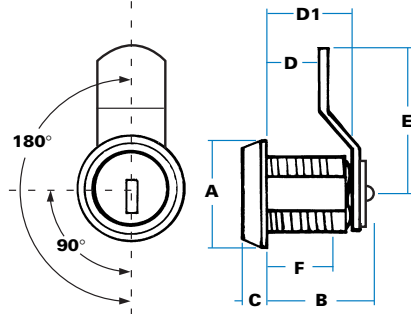

A	Head diameter	26 mm
B	Total depth	27 mm
C	Head projection	6 mm
D	Depth to cranked latch	11 mm
D1	Body depth	19 mm
E	Height of bar	37 mm
F	Thread depth	15 mm

latch bar reversible, can be fitted at 45° intervals.

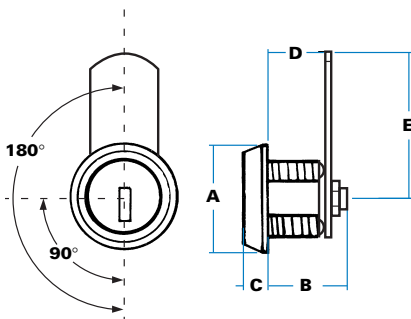

SPECIFICATION

A	Head diameter	26 mm
B	Total depth	20 mm
C	Head projection	6 mm
D	Depth to latch	13 mm
E	Height of bar	35 mm

Latch bar must be removed for mounting.



7/22931

ORDERING CODE

7/22932	'Short body' lock, 90°, mixed keys
7/22932/01	'Short body' lock, 90°, FS 880
7/22931	'Short body' lock, 180°, mixed keys
7/22931/01	'Short body' lock, 180°, FS 880

Flat latch bar as standard, can be fitted at 45° intervals: Order locating plate separately.



90° or 180° rotation as shown. Note that key does not withdraw in unlocked (9 o'clock) position with 90° models.



'FS' keys only, with 'shuttered' keyway.

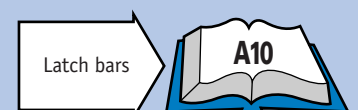



ORDERING CODE

- 7/25250** 19 mm lock, 90°, mixed keys
- 7/25250/01** 19 mm lock, 90°, FS 880

7/1905, spiked locating plate for wooden panels Panel-piercing detail

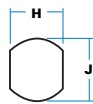
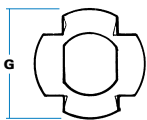

Offset aperture by 45° to compensate for orientation of keyway

- G** Diameter, locating plate 34 mm
- H** Piercing, across flats 17.5 mm
- J** Piercing, diameter 20 mm

Locating plate enables lock to be fitted into a round hole.
Latch bar must be removed for mounting.

SPECIFICATION

For clarity, retaining nut is not shown

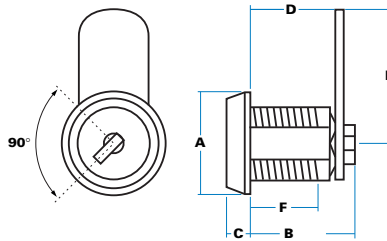

- A** Head diameter 26 mm
- B** Total depth 28 mm
- C** Head projection 6 mm
- D** Depth to latch 19 mm
- E** Height of bar 35 mm
- F** Thread depth 15 mm

Latch bar can be fitted at 45° intervals.

**COMPARTMENT
LOCKS [19mm]
WITH 90° KEY-
WITHDRAWAL**

These are special models with 90° rotation, but in which keys can be withdrawn in both locked and unlocked positions. All details are as the 19mm 'de-luxe' specification, with spiked locating plate provided, but with straight latch bar as standard.



Keyway is oriented at 45° to 'flats' on body: adjust panel-piercing to compensate or use round hole with spiked locating plate.



'FS' keys as standard with 'shuttered' keyway. Optionally 'FT', '92' or 'DLP' key types.



Wide choice of latch bars, finish options and accessory items. Special key numbers or sets on request.

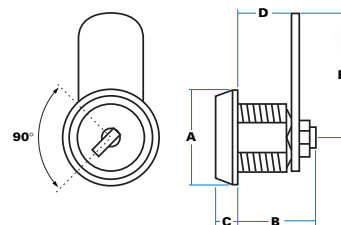

ORDERING CODE

- 9/00927** 13 mm lock, 90°, mixed keys
- 9/00927/01** 13 mm lock, 90°, FS 880

Flat latch bar as standard, can be fitted at 45° intervals.
Order locating plate separately

SPECIFICATION

- A** Head diameter 26 mm
- B** Total depth 20 mm
- C** Head projection 6 mm
- D** Depth to cranked latch 13 mm
- E** Height of bar 35 mm

**'SHORT BODY
LOCKS' [13mm]
WITH 90° KEY-
WITHDRAWAL**

Also with 90° key-withdrawal, these locks have overall length at 7 mm less than standard. It can be further reduced with optional moulded spacer



'FS' keys only.



7/01905
Locating plate



9/00589

ORDERING CODE

9/00589	30 mm lock, 90° mixed keys
9/00589/01	30 mm lock, 90°, FS 880
9/00590	30 mm lock, 180°, mixed keys
9/00590/01	30 mm lock, 180°, FS 880

7/1905, spiked locating plate for wooden panels
Panel-piercing detail

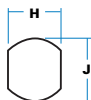
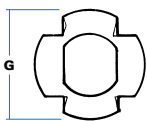

Offset aperture by 45° to compensate for orientation of keyway

G	Diameter, locating plate	34 mm
H	Piercing, across flats	17.5 mm
J	Piercing, diameter	20 mm

SPECIFICATION

For clarity, retaining nut is not shown

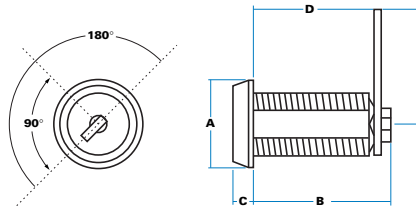

A	Head diameter	26 mm
B	Total depth	35 mm
C	Head projection	8 mm
D	Depth to latch	30 mm
E	Height of bar	35 mm

Latch bar can be fitted at 45° intervals and must be removed for mounting

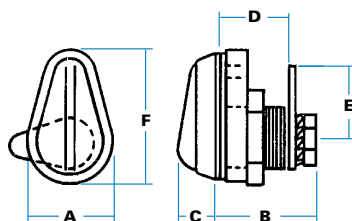

ORDERING CODE

7/08996	'Weathershield' lock, 90°, 'FS'
7/08996/01	'Weathershield' lock, 90°, FS 880
9/00849	'Weathershield' lock 90°, 'FT'

Special latch bar 7/08995 fits at 90° intervals. 180° rotation to special request.

SPECIFICATION

A	Max. width (face)	25 mm
B	Total depth	27 mm
C	Head projection	12 mm
D	Depth to latch	19 mm
E	Height of bar	20 mm
F	Max height (face)	38 mm



7/08996

'LONG BODY' LOCKS [30mm] with 90° KEY-WITHDRAWAL

With extended body depth to 30 mm, these locks are ideal for thick panels (chipboard, composites), and keys can be withdrawn in locked and unlocked positions with both 90° and 180° models.

Locks have 'shuttered' keyway for weather protection, with spiked locating plate and straight latch bar.



Keyway is oriented at 45° to 'flats' on body: adjust panel-piercing to compensate or use round hole with spiked locating plate..



'FS' keys as standard with 'shuttered' keyway. Optionally 'FT', '92' or 'DLP' key types.



Wide choice of latch bars, finish options and accessory items. Special key numbers or sets on request.

'WEATHERSHIELD' LOCKS - FOR EXTERIOR USE

A special model, with pivoted diecast cover which protects keyway against dust and water. Normally 90° operation with key withdrawing in both positions. Chrome, with 'FS' or 'FT' keys and full choice of latch bars.



A special piercing is required. Diecast spacer is provided for fitting above or below panel surface as required



ORDERING CODE

9/00112	'Tri-lock', all-black
9/00113	'Tri-lock', chrome
9/00129	Key for tri-lock, steel
9/00612	Square-drive lock, black
9/00613	Square-drive lock, chrome
9/00629	Key for square-drive lock

7/1905, spiked locating plate for wooden panels Panel-piercing detail

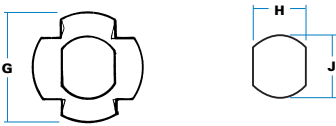

G	Diameter, locating plate	34 mm
H	Piercing, across flats	17.5 mm
J	Piercing, diameter	20 mm
K	Special keys, length	62 mm

Locating plate must be ordered separately with this specification. Latch bar reversible, can be fitted at 45° intervals.

SPECIFICATION

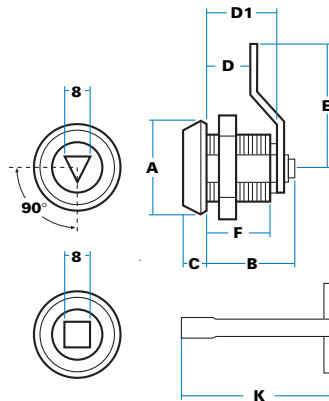

A	Head diameter	26 mm
B	Total depth	27 mm
C	Head projection	6 mm
D	Depth to cranked latch	12 mm
D1	Body depth	19 mm
E	Height of bar	37 mm
F	Thread depth	15 mm

'TRI-LOCKS' & SQUARE-DRIVE LOCKS [19mm]

[1/4-TURN FASTENERS]

Attractive locks for low-cost security, using housings and fittings interchangeable with key-operated models.

Two styles are available, with either 8 mm-square or triangular plug, with keys to match. Both are suitable for exterior use and can be water-sealed to IP55 if required.



90° rotation as shown. To special order locks can travel through 180°.



All-black as standard, or with chromium-plated housing. Optionally, bright zinc-plated for lowest cost.



Wide choice of latch bars, finish options and accessory items.

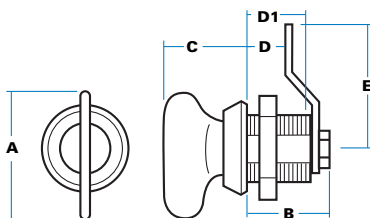

SPECIFICATION

A	Height of key	32 mm
B	Total depth	20 mm
C	Head projection	25 mm
D	Depth to cranked latch	6 mm
D1	Body depth	13 mm
E	Height of bar	37 mm



ORDERING CODE

9/00123 Fixed-key lock, black & chrome.
Locating plate must be ordered separately with this specification.

'FIXED-KEY' PANEL FASTENER

A useful 'quarter-turn' fastener with a diecast turn-key permanently retained in the housing, making it useful for interior cabinets, inspection panels, etc. Black key within chrome housing.



Wide choice of latch bars, finish options. 180° rotation and other lengths to special order.

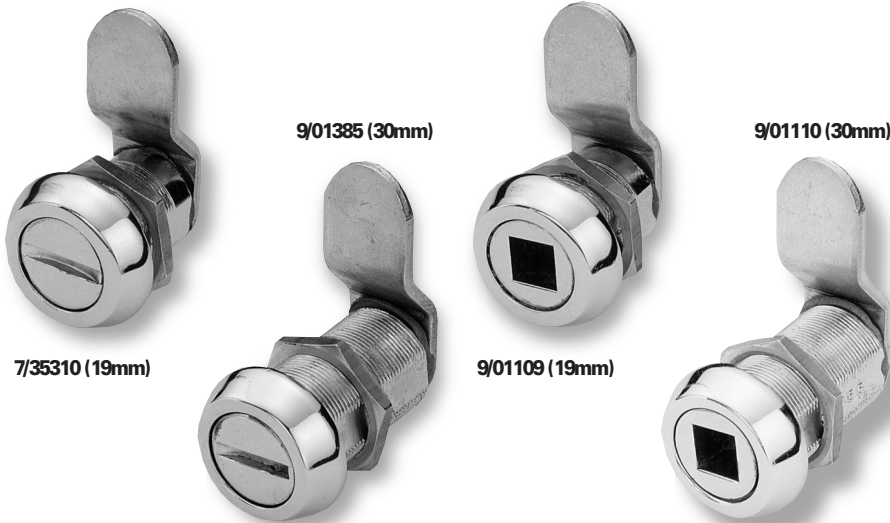

**TOOL-OPERATED
COMPARTMENT
LOCKS**

[1/4-TURN FASTENERS]

Two styles of 'quarter-turn' fasteners, using standard housings and fittings so they are interchangeable with key-operated models. Both are available in 19 mm & 30 mm lengths.

The 'recess-square' design allows relatively high turning force to be applied (using the 8 mm T-key). The 'coin-op' model is used as a convenient catch, opened with almost any coin or screwdriver blade.



90° rotation as shown. To special order locks can travel through 180°.



Bright chromium-plated as standard. Optionally, black or bright zinc-plated.



Wide choice of latch bars, finish options and accessory items.

ORDERING CODE

7/35310 'Coin-op' lock, 19 mm

9/01385 'Coin-op' lock, 30 mm

9/01109 Recess-square lock, 19 mm

9/01110 Recess-square lock, 30 mm

9/00726 T-key for recess-square locks

7/1905, spiked locating plate for wooden panels

Panel-piercing detail

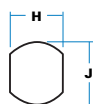
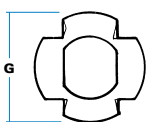

G Diameter, locating plate 34 mm

H Piercing, across flats 17.5 mm

J Piercing, diameter 20 mm

K T-key, length 62 mm

Locating plate must be ordered separately with this specification. Latch bar reversible, can be fitted at 45° intervals.

SPECIFICATION

'Slot',
2.5mm x 5mm
max. depth

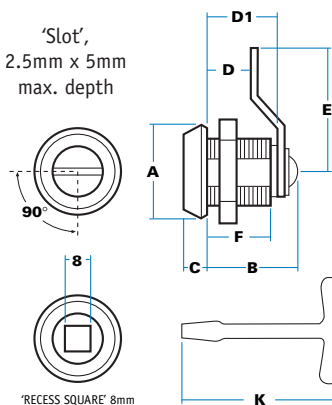

A Head diameter 26 mm

B Total depth 27 mm/38 mm

C Head projection 6 mm

D Depth to cranked latch 12 mm/23 mm

D1 Body depth 19 mm/30 mm

E Height of bar 37 mm

F Thread depth 15 mm/30 mm

9/00858
Finger-pull

Black, moulded design which improves access to cabinet door. Suits all models

9/00928
Moulded weathershield

Black PVC cover for weather-protection. Suits all round-face locks.





Double-sided 'FT' keys as standard



9/01930

ORDERING CODE

- 9/01930** Low-profile lock, 90°, mixed keys
- 9/01930/01** Low-profile lock, 90°, FT 111
- 9/01931** Low-profile lock, 180°, mixed keys
- 9/01931/01** Low-profile lock, 180°, FT 111

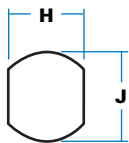

'Type 2' piercing
This larger aperture
also suits our 'easy-fix'
range of handles.

- G** Diecast spacer (depth) 6 mm
 - H** Piercing, across flats 22 mm
 - J** Piercing, diameter 24 mm
- Latch bar reversible, can be fitted at 45° intervals.

SPECIFICATION

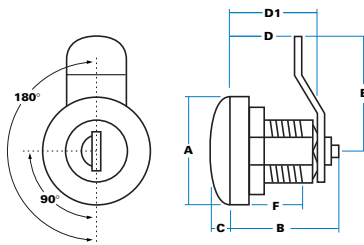

- A** Head diameter 30 mm
- B** Total depth 29 mm
- C** Head projection 5 mm
- D** Depth to cranked latch 15 mm
- D1** Body depth 22 mm
- E** Height of bar 37 mm
- F** Thread depth 17 mm

**LOW-PROFILE
COMPARTMENT
LOCKS**

A new model, designed with a "shuttered" cylinder for weather protection but with a wider, lower head style for enhanced appearance. Larger panel-piercing to match our 'easy-fix' handles, with nut-fixing for latch bar. A neoprene gasket and diecast spacer are provided. Finish is bright chromium-plated.



90° or 180° rotation as shown. Key will withdraw in unlocked (9 o'clock) position with 90° models.



'FT' keys as standard with 'shuttered' keyway. Optionally 'FS', '92' or 'DLP' keys.



Wide choice of latch bars, finish options. Special key numbers or sets.



7/24385 Spring
Fixing clip (supplied
with locks)



1/29400-1 (Supplied
as pairs)

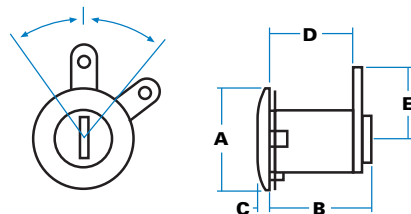

ORDERING CODE

- 1/29400-1** 'Private' locks, LH/RH pair, complete with spring clip.

Request engineering drawing for panel cut-out dimensions.

SPECIFICATION

- A** Head diameter 30 mm
- B** Total depth 33 mm
- C** Head projection 2 mm
- D** Depth to bar 25 mm
- E** Height to hole centre 16 mm

**VEHICLE
'PRIVATE' (DOOR)
LOCKS**

Used with non-locking exterior handles (see B25), these locks have very low profile and twin-lobed operating bar. Supplied as pairs, LH/RH, chromium-plated, 'FT' keys only.



Key enters and withdraws vertically with 'lost motion' allowed, and 45° movement of bar to each side of rest position.



Mount in special pierced aperture and secure from inside with spring clip. Gasket provided.



'Cranked'
Latch Bars

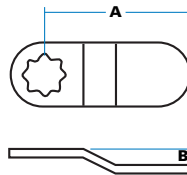

Part number	A	B
7/01906	36mm	8mm
9/00033	30mm	4mm



'Straight'
Latch Bars

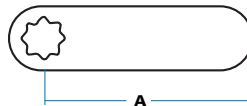

Part number	A
9/00526	23mm
7/03640	35mm
7/35232	51mm
5/00458	76mm

LATCH BAR OPTIONS FOR COMPARTMENT LOCKS

These are some of the more commonly-used latch bars for our compartment lock range. All are made in mild steel, 15 mm x 2.2 mm, and zinc-plated, with an 8-sided hole to accept 8 mm-square drive (unless otherwise noted). All are reversible.

Standard lock models are normally fitted with the 'cranked' bar (7/01906) or the 'straight' bar, (7/03640). However, any of these options can be provided on request, and special bars made to order where volumes are appropriate.

A range of 3 mm heavy-duty bars with raised cam-form is also available and is shown separately.



'Hooked'
Latch Bars

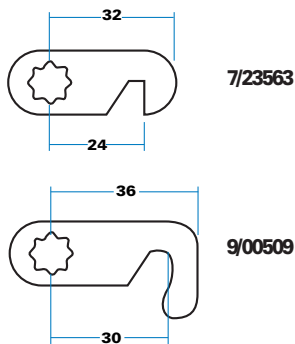

'Plunger'-type
Latch Bars

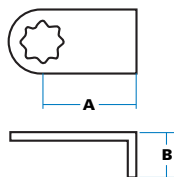

Part number	A	B
5/00960	8mm	14mm
5/02051	10mm	13mm
5/01907	13mm	17mm
5/00474	10mm	30mm

Note: 5/00960 has a 4-sided hole and 'Plunger' is reduced to 6mm width.



'Special'
Latch Bars

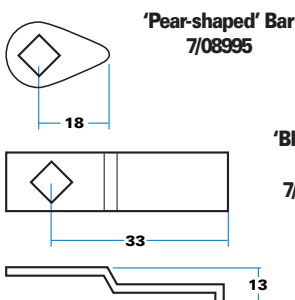

7/23709

Note: These latch bars have 4-sided hole only.

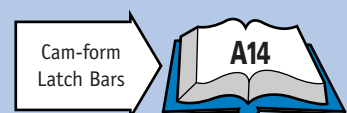



'FT' Keys
Optional



Single-sided 'FS' keys
are standard



9/00935
'Compact'
Handle

'COMPACT' LOCKING HANDLE WITH 'EASY-FIX' MOUNTING

Our 'Compact' model takes very little more space than a compartment lock, but it removes the load from the key. With cam-formed latch (or rods) it can be used even on gasketed doors, and can be water-sealed if required.

ORDERING CODE

9/00935	Compact, chrome, 90° LH
9/00935/01	As above, FS 880 keys
9/00936	Compact, chrome, 90° RH
9/00936/01	As above, FS 880 keys
9/00937	Compact, chrome, 180°
9/00937/01	As above, FS 880 keys

Panel-piercing detail

This larger aperture also suits our 'easy-fix' range of 'L' & 'T' handles

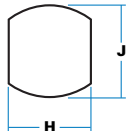

H Piercing across flats	22 mm
J Piercing, diameter	24 mm

SPECIFICATION

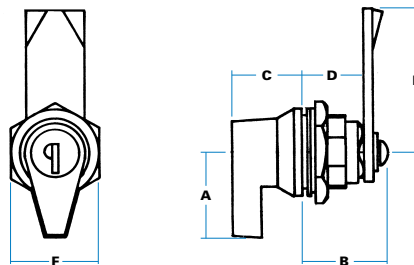

A Face length	40 mm
B Body depth	29 mm
C Face height	25 mm
D Depth to latch	19 mm
E Height of latch	48 mm
F Face width	30 mm

Latch bar can be fitted at 90° intervals

Latch-bar options

Straight bar is fitted as standard

5/00276
Cranked 'up'
9.5mm

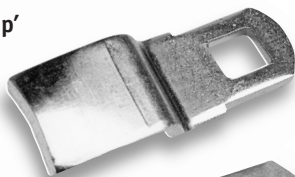

5/00275
'straight'

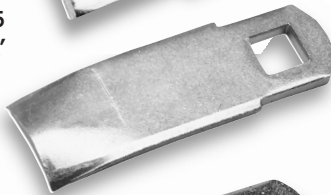

5/00097
Cranked 'down'
9.5mm



Straight latch bar is fitted as standard, with two options cranked 9.5 mm 'up' or 'down'. Lock will accept all other bars with 8 mm piercing, including 2/3-point options.

90° LH/RH MOVEMENT

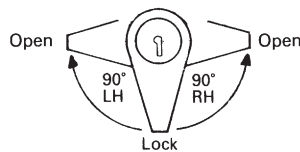

Handles operate LH (clockwise) or RH (anticlockwise) but lock in vertical position only. Key does not withdraw in 'open' position.

180° MOVEMENT

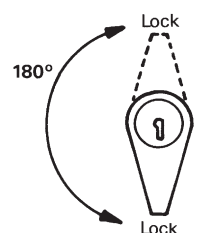

Handles are non-handed and lock in both vertical positions, when key can be withdrawn.



Rotation is 90° LH or RH as shown, or 180°. Key operates only when handle is vertical but key withdraws in both top & bottom (locked) positions.



Insert from front into pierced aperture and fix with large hexagonal nut. Neoprene gasket and stainless spring washer are provided.



'FS' keys as standard with 'shuttered' keyway. Optionally 'FT' or 'DLP' key types.



Bright chromium-plated or black powder-coated.



- Cranked latch bars
- 2/3-point bars & rods
- Water-sealing to IP standards
- Special key numbers or sets.

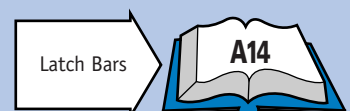



Double-sided
'FT' Keys are
standard



9/01861

ORDERING CODE

9/01861 Turnbutton, chrome, 90° LH

9/01861/01 As above, FT111 keys

Panel-piercing detail

This larger aperture also suits our 'easy-fix' range of 'L' & 'T' handles.

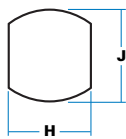

H Piercing across flats	22 mm
J Piercing, diameter	24 mm

SPECIFICATION

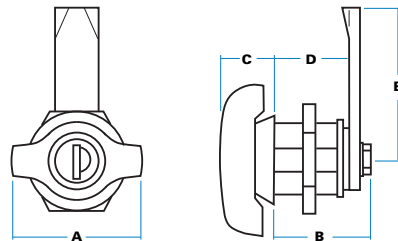

A Face width	45 mm
B Body depth	37 mm
C Face height	14 mm
D Depth to latch	30 mm
E Height of latch	48 mm

Latch bar can be fitted at 90° intervals

Latch-bar options

Straight bar is fitted as standard

5/00276
Cranked 'up'
9.5mm



5/00275
'straight'

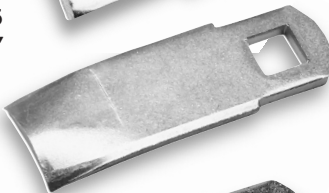

5/00097
Cranked 'down'
9.5mm



Straight latch bar is fitted as standard, with two options cranked 9.5 mm 'up' or 'down'. Lock will accept all other bars with 8 mm piercing, including 2/3-point options.

90° LH MOVEMENT

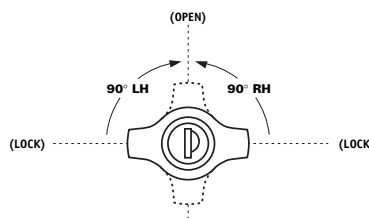



Handles operate LH (clockwise) but lock in horizontal position only. Key does not withdraw in 'open' position.

**'TURNBUTTON'
LOW-PROFILE
LOCK UNIT
['WING' HANDLE]**

The 'turnbutton' lock is fitted with a direct-action operating bar, making it an extremely low-profile handle for securing doors or for driving rod mechanisms.

 Rotation is 90° LH. Key operates only when handle is horizontal, but key withdraws in both locked positions.

 Insert from front into pierced aperture and fix with large hexagon nut. Neoprene gasket and stainless spring washer are provided.

 'FT' keys as standard with 'shuttered' keyway. Optionally 'FS' or 'DLP' key types.

 Bright chromium-plated or black powder-coated.

 - Cranked latch bars
- 2/3-point bars & rods
- Special key numbers or sets

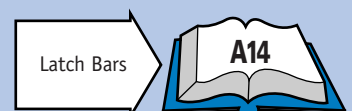



Double-sided
'FT' Keys are
standard



9/01875

ORDERING CODE

9/01875	Turnbutton, chrome, LH
9/01875B	Turnbutton, black, LH
9/00078	Connecting link rod, 1-metre
3/13390	Connecting clip
9/00138	Recess pan, black
5/00939	Gasket for recess pan

Panel-piercing detail

This larger aperture also suits our 'easy-fix' range of 'L' & 'T' handles

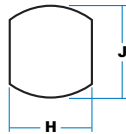

H	Piercing across flats	22 mm
J	Piercing, diameter	24 mm

SPECIFICATION

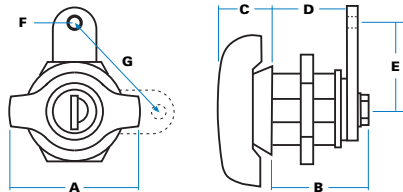

A	Face width	45 mm
B	Body depth	37 mm
C	Face height	14 mm
D	Depth to drive plate	30 mm
E	Height to hole	20 mm
F	Hole size	(dia) 4 mm
G	Travel (max)	25 mm

**'TURNBUTTON'
REMOTE- ACTION
LOCK UNIT
(SPRING-RETURN)**

A very low profile design with spring return, used to operate a latch or mechanism which is mounted remote from the lock itself. It has been widely used as a vehicle boot (trunk) and tailgate lock.



Turn lock through 90° LH to rotate drive plate and operate attached linkage. Spring returns turnbutton to horizontal position. Key turns through 180° to prevent movement and withdraws in both positions.



Insert from front into pierced aperture and fix with large hexagonal nut. Neoprene gasket and stainless spring washer provided.



FT' keys as standard with 'shuttered' keyway. Optionally 'FS' or 'DLP' key types.



Bright chromium-plated or black powder-coated.



- Drive plate length/orientation
- 2-way connecting plate
- Can be used with our 'claw' and 'rotary' latches, or 'intermediary' unit, 1/29736.

FULLY FLUSH-MOUNTING



Where surface projection is not desirable the 'turnbutton' can be fitted into our steel recess pan to provide a totally flush-mounted lock.

DIRECTION OF MOVEMENT

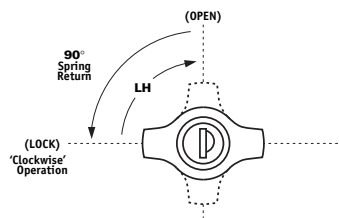

Lock turns 90° in a clockwise direction, and is returned to horizontal by spring-action. It will only lock in the 'rest' position.

APPLICATION SCHEME

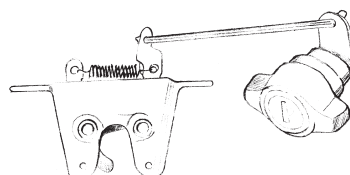

'Turnbutton' can be connected to operating trigger on our 'claw' latches (9/00283, etc.)



Cam-form bars



5/00276



5/00275



5/00097

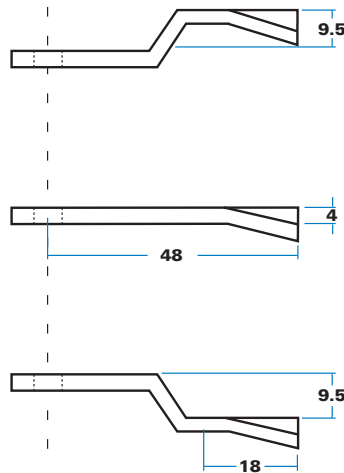

5/02706
Raised 23mm

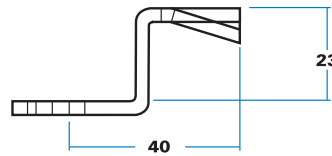

5/02721
Raised 30mm

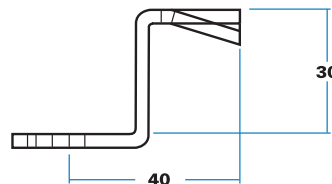

Two-point bars

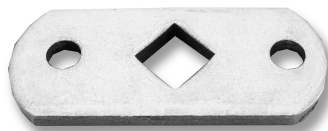

5/00508 (illustrated)
5/01911 with in-line square

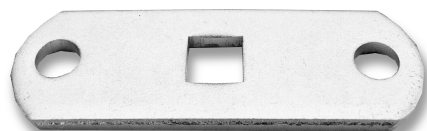
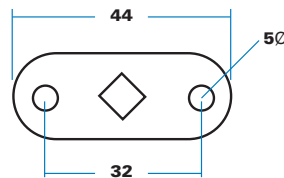

5/00789 (illustrated)
5/01389 with square at 45° to centre line

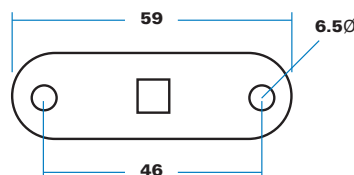

CAM-FORM & MULTI-POINT LATCH BARS

These bars are in 3 mm-thick mild steel, zinc-plated with 8 mm-square hole. Cam-form types have a 4 mm 'leading edge' for good engagement. They can be used with most of our compartment locks, 'Compact' and 'Turnbutton' models, and also with handles having 8 mm square shaft, as illustrated below.

Latch bar fitted to locking handles

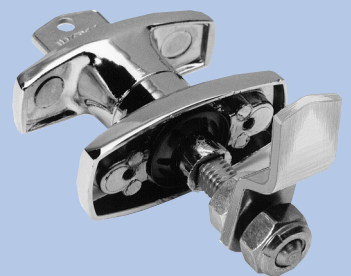

The 8 mm shaft is threaded M10 so that square form is retained. Bar can be adjusted using nut (MP00221) and locknut (MP00220) illustrated



5/01464
Striker plate



Single-sided 'FS'
keys are standard



7/06433
Desk lock

'DESK LOCK' (KEY-OPERATED DEAD-BOLT)

Designed originally for wooden furniture, this is a key-operated 'deadbolt' lock (does not slam). It is a simple and inexpensive unit which can be used for any small cabinet or drawer.

Finish: chromium-plated.



Square-section bolt is thrown as key is turned through 180°. Key withdraws in both positions.



Insert from rear so that housing protrudes through round hole (20 mm dia). Secure through fixing holes in rear flange. Striker plate available.



'FS' keys only, non-shuttered.

'PUSH-BUTTON 'CUBBY' LOCK WITH SLAM-BOLT

This is a popular and well-proven 'cubby' lock, which slams shut and is opened by push-button action. Its small size and simple method of fixing makes it suitable for inspection windows, control boxes, etc.



Lock slams against panel edge, opens with gentle pressure on front face. Key turns 90° to 'block' button.



Insert from front into special piercing, secure with brackets provided at rear. Suits panels up to 2mm (special brackets for thicker panels).



'FS' keys only, non-locking model available.

ORDERING CODE

7/06433	Desk lock, chrome
7/06433/01	Desk lock, FS 880 keys
5/01464	Striker plate, chrome

Striker plate, 5/01464

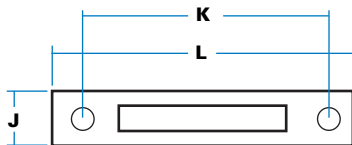

J	Striker width	18 mm
K	Striker hole centres	40 mm
L	Striker length	50 mm

SPECIFICATION

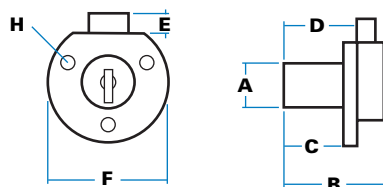

A	Face diameter	19 mm
B	Body depth	29 mm
C	Head depth	17 mm
D	Depth to bolt	25 mm
E	Depth 'throw'	7 mm
F	Diameter	40 mm
H	Hole sizes	3 mm

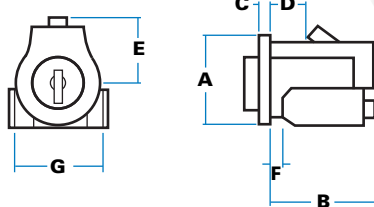

SPECIFICATION

A	Face height	25 mm
B	Body depth	28 mm
C	Rim thickness	4 mm
D	Location to bolt	8 mm
E	Centre-line to bolt	15 mm
F	Tolerance (panel thickness)	2 mm
G	Body width	22 mm

Request drawing for panel-piercing.

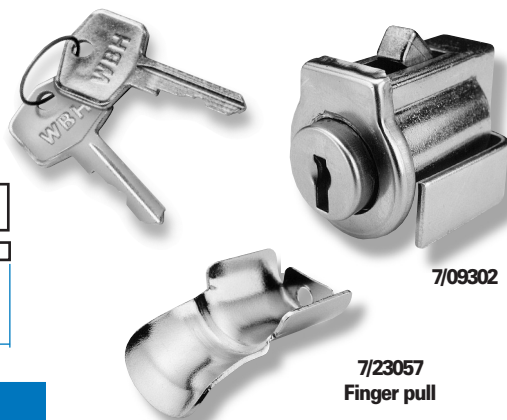

ORDERING CODE

7/09302	Cubby lock
7/09303	Cubby lock, FS 880
7/09280	Cubby lock, plain button
7/23057	Finger-pull, chrome

Note Finger-pull is optional and secures behind fixing-bracket. Finish is stainless steel (satin) or black to special order.

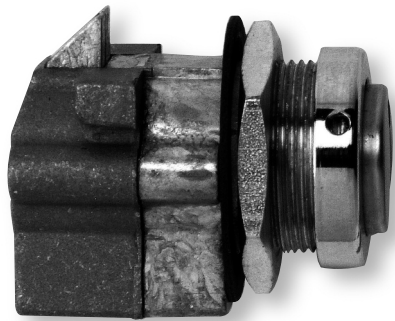

7/07290
showing bezel with holes for tightening onto threaded 'neck'

ORDERING CODE

7/07290	Push-button lock, 'FS' keys
7/07290/01	As above, FS 880 keys
7/07291	Push-button lock, plain lock

Note: An earlier, similar lock was offered as 7/07289. Enquire about compatibility

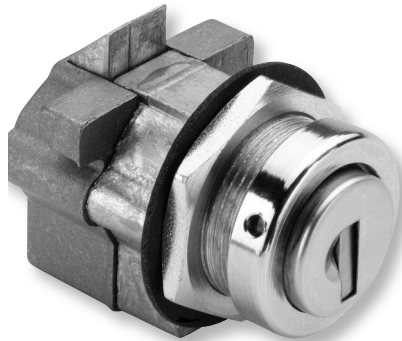

SPECIFICATION

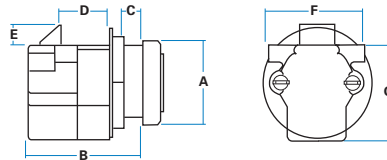

A Face diameter (bezel)	23 mm
B Max. depth	31 mm
C Tolerance (panel thickness)	up to 5 mm
D Location to bolt	13 mm
E Bolt travel	5.5 mm
F Max. width	27 mm
H Max Height	26 mm

Request drawing of panel-piercing required.

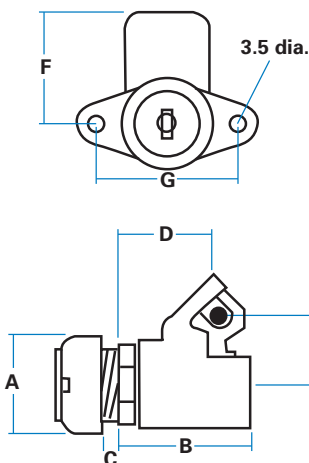

SPECIFICATION

A Face diameter (bezel)	25 mm
B Max. depth	27 mm
C Tolerance (panel thickness)	up to 3 mm
D Location to striker rod	23 mm
E Centre-line to striker	20 mm
F Centre-line to top	30 mm
G Hole centres	40 mm

Request drawing for panel-piercing required.



1/29072

ORDERING CODE

1/29072	Push-button lock, 'FT' keys
1/29072/01	As above, FTIII Key
1/29073	Push-button lock, plain button

619

PUSH BUTTON LOCK WITH SLAM-ACTION

This is a useful lock for lids and compartments, which slams shut and is opened by pushing the front button. It is easily fixed and can accommodate some variation in panel thickness.



Lock slams against panel edge or striker, opens with gentle pressure on front face. Key turns 180° to block button.



Insert from rear into panel cut-out, fit bezel onto threaded 'neck' and tighten using circlip pliers or similar tool. Large nut allows adjustment to suit panel thickness.



'FS' keys only, non-locking model available.



'FS' keys only, chrome bezel and stainless steel button.

'PUSH-BUTTON LOCK WITH 'SECURITY' ACTION

This lock was developed to prevent accidental opening of compartments where movement and vibration are involved. It slams against a suitable rod or loop (3mm diameter), and is opened by pushing the front button. The rotary 'claw' provides much more secure fixing than a slam-bolt lock.



Lock slams against striker, opens with gentle pressure on front face. Key turns 180° to block button.



Insert from rear into circular panel cut-out, fix through front flange. A large chrome finishing bezel screws onto threaded 'neck' for good appearance and allows some adjustment for panel thickness.



'FT' keys only, non-locking model available.



1/06280
Ignition barrel



Ignition switch with
assembled lock
barrel, bezel, and
special 'customised'
key

SWITCH POSITIONS - FRONT VIEW

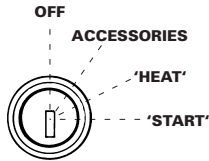

TERMINAL POSITIONS

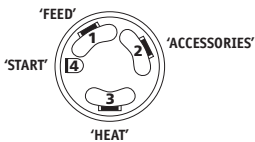

ORDERING CODE

5/02090	Ignition switch only (35640D)
1/06280	'FS' ignition barrel, non-shuttered
1/07906	'FS' ignition barrel, shuttered
1/09280	'92' ignition barrel, non-shuttered
1/09151	'FT' ignition barrel, shuttered
5/02136	Deep bezel (optional)
5/02336	Standard Lucas bezel, chrome

SPECIFICATION

A	Total switch height	56 mm
B	Boss height	29 mm
C	Thread height	16 mm
D	Base diameter	54 mm
E	Terminal projection (max)	16 mm
F	(Deep) bezel height	6 mm
G	Head, diameter	19.6 mm
H	Across 'flat'	18.4 mm

Maximum current recommended at 'start' is 16.5 amps. Electrical connectors are 'Lucar' blade terminals.

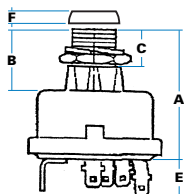

The special 'deep' bezel must be used with the 'FT' barrel, 1/09151

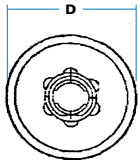

ORDERING CODE

7/27693	'Butterfly' ignition barrel
9/01874	'Butterfly' barrel, non-locking

The butterfly barrel is only available in the 'FS' key series.



7/27693
Ignition barrel with
chromium-plated
'butterfly' head

These are well-known 'Lucas' key-operated 24 volt rotary switches, suitable for commercial, agricultural and industrial uses. The model shown suits diesel engines, with the most commonly used terminal configuration, many other versions available.

WBH ignition barrels have a spring-loaded plunger, allowing 'snap-in' fitting. They can be supplied to special key number, allowing ignition to be matched to a full vehicle lock-set. 'Shuttered' head for weather-protection when required.



Key is inserted to unlock, turned through the 'accessory' position and against a strong return spring for 'heat' and 'start' operation.



Switch fits from rear through a pierced aperture and is retained by nut, spring washer and trim-bezel. Lock barrel is 'snapped-in' and can be released through hole in side of switch housing.



'FS' & 'FT' as standard with 'shuttered' head if required. Optionally, '92' or 'DLP' key types.



Many other types of 'Lucas' switch are available on request, including tool-operated and 12-volt models, in three, four and five-position versions.

'BUTTERFLY' IGNITION BARREL









This clever design allows for easy operation (with gloved hand) and provides support for the key to prevent breakage in the lock. It will fit all 'Lucas' switches.



515547
Shown with
'customised' keys

STEERING COLUMN LOCKS, 'IN-LINE' MODELS

This robust lock provides protection against casual theft and unauthorised use of trucks and specialist vehicles. Installed as an OE fitment, it is clamped around the steering column (45 mm dia) and incorporates an ignition switch at either 12V or 24V.

-  High-security double-sided key, choice of switches with easy replacement if necessary and moulded terminal cover.
-  When key is removed the locking bolt will engage into a slot in the steering column, preventing movement.
-  Key enters, is turned 60° to withdraw locking bolt and activate "accessories" circuits, then a further 60° to "start", returning by spring-action to "run" position. A blocking device prevents accidental engagement of bolt while the engine is running.
-  Secure by 4-off "shearhead" bolts, which are then snapped-off to prevent removal.
-  Lateral pin-tumbler lock with 3500 combinations. Alternatively, conventional pin-tumbler lock (with 'FR' type single-sided keys).
-  As-cast or zinc-plated finish, with satin chrome faceplate.
-  Zinc-diecast body, brass lock cylinder, steel locking bolt, moulded switch cover.
-  - Alternative switches
- Specified key numbers

ORDERING CODE

- 515547** Steering lock, 'lateral-pin' keys
515544 Steering lock, 'conventional' keys

Other types of lock are available as shown below:

Yoke-mounted models



Side-mounted models



515595
Shown with
locking bolt
extended

SPECIFICATION

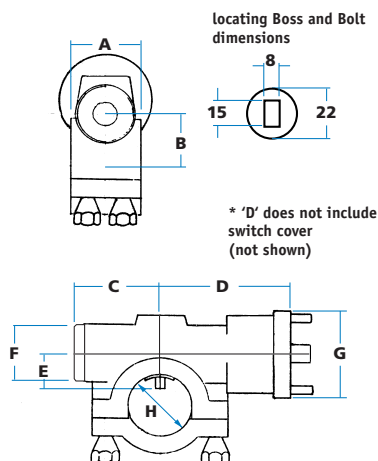

A Body width	45 mm
B Height (centre to base)	33 mm
C Length (face to centre)	45 mm
D Length (centre to rear)	64 mm*
E Height (centre to bolt)	21 mm
F Diameter, faceplate	30 mm
G Diameter, switch housing	55 mm
H Diameter, yoke	45 mm

Bolt projection when locked 9 mm

24-volt Lucas switch ref. 500922, with 4-off twin terminals for standard connectors (consult engineering drawing for switch positions).

HANDLES

**EXTERIOR
HANDLES,
PUSH-BUTTON,
RECESS, &
'FLUSH' DESIGNS**



New, semi-flush
recess latch for
machinery enclosures



Above: 'Heavy-T' handle with
sliding 'weathershield' plate to
protect lock cylinder

This section illustrates a great variety of diecast outside handles, ranging from 'L' & 'T' models, through to push-button and 'flush' designs for vehicle applications. These can be 'customised' to provide exact finish and operational mode required. Some models are also available in stainless steel.

Special handles can be designed for particular applications, volume permitting, and can be matched with other items as a full vehicle lock-set.



'FT' Keys
Optional



Single-sided 'FS' keys
are standard



9/00975
Small 'T' with 'easy-
fix' mounting

SMALL 'T' HANDLES WITH 'EASY-FIX' MOUNTING

Very neat useful handles with circular 'easy-fix' escutcheon that are mounted through a standard pierced aperture. Lock cylinders are "shuttered" for weather-resistance, and handle can be water-sealed. Non-locking models available.

ORDERING CODE

9/00975	Small 'T', locking, chrome
9/00975/01	As above, FS 880 keys
9/00975B	Small 'T', locking, black
9/00975B/01	As above, FS 880
9/00976	Small 'T', non-locking, chrome
9/00976B	Small 'T', non-locking, black

SPECIFICATION

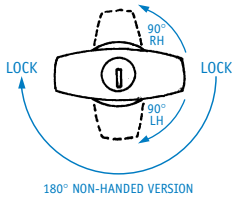

Handles operate through 180° as standard (non-handed), locking in two positions. To special order, rotation can be limited to 90° LH (clockwise) or 90° RH (anticlockwise), when handle will only lock in the rest position. Illustration shows handle with 'flats' vertical on escutcheon.

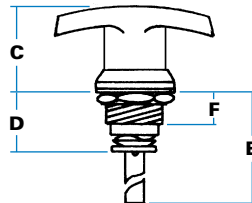
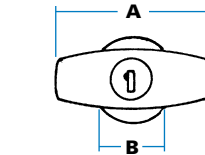

A	Handle length	65 mm
B	Face width	30 mm
C	Face height	30 mm
D	Body depth	26 mm
E	Total projection (shaft length)	63 mm
F	Depth of thread	15 mm

PANEL-PIERCING DETAIL

This larger aperture also suits our other 'easy-fix' handles, 'Turnbutton' and 'Compact' models.

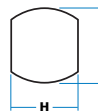

H	Piercing across flats	22 mm
J	Piercing, diameter	24 mm

THREADED SHAFT & FITTED LATCH BAR

The 8 mm square steel shaft can be threaded M10 so that the form is retained, but allowing a latch bar to be fitted and secured using nut (MP00221) and locknut (MP00220) illustrated.



180° as standard, rotation can be limited to 90°, LH/RH when required.



Mount through panel piercing against 'flats' on escutcheon, and secure with large brass nut. Neoprene gasket and stainless spring spacing washer are provided.



'FS' keys as standard with 'shuttered' keyway optionally 'FT' or 'DLP' key types.



Chromium plated or black powder coated



- Shaft lengths
- Threaded shafts (M10)
- Special key numbers/sets
- 90° LH/RH rotation

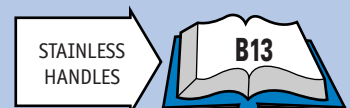
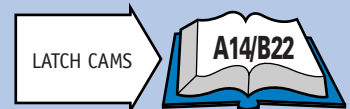

Small 'T' with
adjustable latch bar



Single-sided 'FS' keys are standard



9/00990
Large 'T' with 'easy-fix' mounting

ORDERING CODE

9/00990	Large 'T', locking, chrome
9/00990/01	As above, FS 880 keys
9/00990B	Large 'T', locking, black
9/00990B/01	As above, FS 880
9/00991	Large 'T', non-locking, chrome
9/00991B	Large 'T', non-locking, black

SPECIFICATION

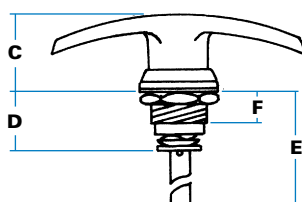
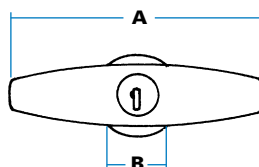

A Handle length	100 mm
B Face width	30 mm
C Face height	30 mm
D Body depth	26 mm
E Total projection (shaft length)	63 mm
F Depth of thread	15 mm

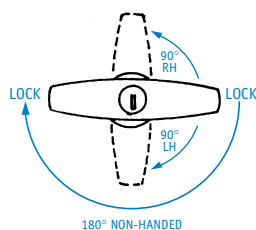

Handles operate through 180° as standard (non-handed), locking in two positions. To special order, rotation can be limited to 90° LH (clockwise) or 90° RH (anticlockwise), when handle will only lock in the rest position. Illustration shows handle with 'flats' vertical on escutcheon.

Large 'T' with 63mm diecast cam, (9/00837)



PANEL-PIERCING DETAIL

This larger aperture also suits our other 'easy-fix' handles, 'Turnbutton' and 'Compact' models.



H Piercing across flats	22 mm
J Piercing, diameter	24 mm

HANDLE WITH DIECAST CAM (LEFT)

Two sizes of diecast cam are available (32 & 63 mm), which can be adjusted on a (plain) 8 mm shaft, and secured with concealed screw.

LARGE 'T' HANDLES WITH 'EASY-FIX' MOUNTING

More substantial handles with circular, 'easy-fix' escutcheon that are mounted through a standard pierced aperture.

Lock cylinders are "shuttered" for weather-resistance, and handle can be water-sealed. Non-locking models available.

180° as standard, rotation can be limited to 90°, LH/RH, when required.

Mount through panel piercing against 'flats' on escutcheon, and secure with large brass nut. Neoprene gasket and stainless spring spacing washer are provided.

'FS' keys as standard with 'shuttered' keyway optionally 'FT' or 'DLP' key types.

Chromium plated or black powder coated

- Shaft lengths
- Threaded shafts (M10)
- Special key numbers/sets
- 90° LH/RH rotation



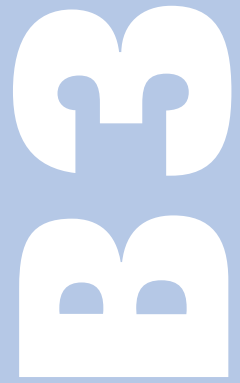

9/00186SS
Recess 'T' in special
stainless steel pan.
(Black is standard)



RECESS 'T' HANDLES WITH 'EASY-FIX' MOUNTING

An extremely useful set that allows our large 'T' handle to be mounted so that the "arms" of the handle do not project above the surface of a panel. The steel recess pan is normally black powder-coated, with moulded gasket. Locking & non-locking models, supplied as boxed sets.



180° as standard, locking in two positions. Rotation can be limited to 90°, LH/RH, or 360° free-movement.



Fix pan in circular aperture, mount handle through centre piercing against 'flats' on escutcheon and secure with large brass nut. Neoprene gasket and stainless spring spacing washer are provided.



'FS' keys as standard with 'shuttered' keyway optionally 'FT' or 'DLP' key types.



Handles are bright chromium plated, with black powder-coated pan. Optionally, pan can be polished stainless steel (Grade 304).



- Shaft lengths
- Threaded shafts (M10)
- Special key numbers/sets
- 90° LH/RH rotation
- All-black handle/pan



Max recommended torque in pan, 16Nm (12lb.ft) - steel, 22Nm (16lb.ft) - stainless.



Our 'drop-T' models are an alternative, self-contained system for heavier duty applications.

'FT' Keys
Optional



Single-sided 'FS' keys
are standard

ORDERING CODE

9/00184	Recess 'T' set, locking
9/00184SS	As above, stainless pan
9/00185	Recess 'T' set, non-locking
9/00185SS	As above, stainless pan
9/00186	Recess 'T' set, FS 880
9/00186SS	As above, stainless pan
9/00138	Recess pan only, black
5/00939	Moulded seal only, black

SPECIFICATION

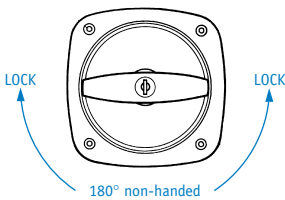
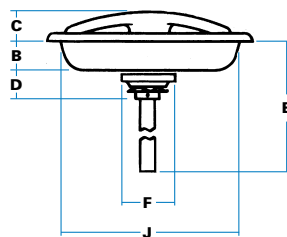
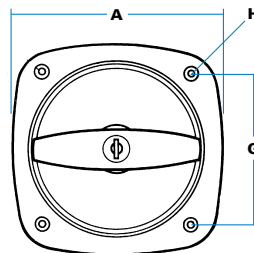

Handles operate through 180° as standard (non-handed), locking in two positions. To special order, rotation can be limited to 90° LH (clockwise) or 90° RH (anticlockwise), when handle will only lock in the rest position. Illustration shows handle with 'flats' vertical on escutcheon.

A	Pan total width	125 mm
B	Pan depth	15 mm
C	Face height	15 mm
D	Depth of fixing	27 mm
E	Total projection (shaft length)	145mm
F	Fixing detail (dia)	32 mm
G	Hole centres	90 mm
H	Hole sizes (dia)	4.75 mm, c/s 9 mm
J	Pan external diameter	105 mm



Illustration shows recess pan with standard pierced aperture and vertical 'flats'.

MOULDED SEAL



The edge of the recess pan is embossed, to seat into corresponding groove in moulded seal.

DROP - T
LATCHES

C23



Single-sided 'FS' keys are standard



9/00960
Lever 'L' with 'easy-fix' mounting

ORDERING CODE

9/00960	Lever 'L', locking, chrome
9/00960/01	As above, FS 880 keys
9/00960B	Lever 'L', locking, black
9/00960B/01	As above, FS 880
9/00961	Lever 'L', non-locking, chrome
9/00961B	As above, non-locking, black

SPECIFICATION

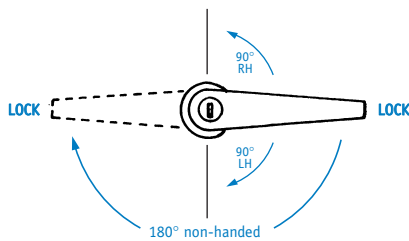

Handles operate through 180° as standard (non-handed), locking in two positions. To special order, rotation can be limited to 90° LH (clockwise) or 90° RH (anticlockwise), when handle will only lock in the rest position. Illustration shows handle with 'flats' vertical on escutcheon.

A special model has handle locking vertical to escutcheon with 45° rotation to either side.



9/00156
'Equilateral' recess pan with handle on RH side

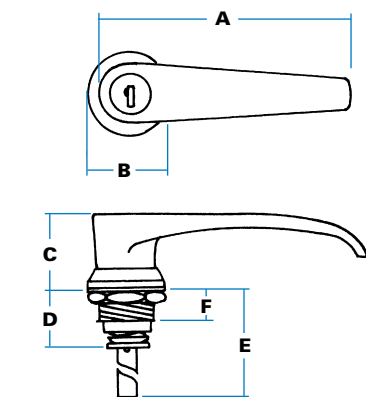

A Handle length	115 mm
B Face width	30 mm
C Face height	30 mm
D Body Depth	26 mm
E Total projection (shaft length)	63 mm
F Depth of Thread	15 mm

PANEL-PIERCING DETAIL

This larger aperture also suits our other 'easy-fix' handles, 'Turnbutton' and 'Compact' models.

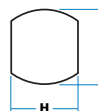

H Piercing across flats	22 mm
J Piercing, diameter	24 mm

HANDLES FOR RECESS FITTING

Versions of this handle are available with 'Equilateral' recess plate, reducing external projection to 15 mm. These are 'handed', and the illustration shows handle fitted on right-side of the pan. Consult sales office for details.

**LEVER 'L'
HANDLES WITH
'EASY-FIX'
MOUNTING**

Stylish and attractive handles with circular, 'easy-fix' escutcheon that are mounted through a standard pierced aperture. Lock cylinders are "shuttered" for weather-resistance, and handle can be water-sealed. Non-locking models available.



180° as standard, rotation can be limited to 90°, LH/RH, when required.



Mount through panel piercing against 'flats' on escutcheon, and secure with large brass nut. Neoprene gasket and stainless spring spacing washer are provided.



'FS' keys as standard with 'shuttered' keyway optionally 'FT', 'DLP' key types.



Chromium plated or black powder coated



- Shaft lengths
- Threaded shafts (M10)
- Special key numbers/sets
- 90° LH/RH rotation

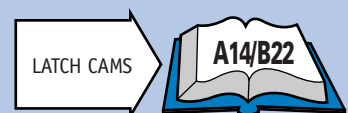

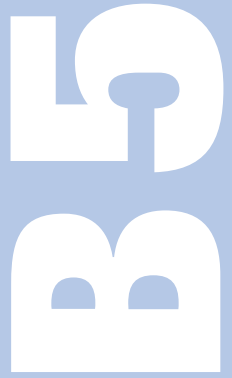

LEVER 'L' HANDLES WITH SURFACE MOUNTING

Good-looking handles with rectangular, surface-mounted escutcheons for either open- or concealed-fixing. Lock cylinders are "shuttered" for weather-resistance and there is choice of 38 mm (1.5 inch) or 44 mm (1.75 inch) hole centres

9/00172
Non-locking 'L' with
38mm concealed fixing



9/00167 Locking 'L'
with 38mm open-
fixing



'FT' Keys
Optional



Single-sided 'FS' keys
are standard

ORDERING CODE

With 38 mm open-fixing

9/00167 Lever 'L', locking, chrome

9/00167/01 As above, FS 880 keys

9/00170 Lever 'L', non-locking, chrome

With 38 mm concealed-fixing

9/00171 Lever 'L', locking, chrome

9/00171/01 As above, FS 880

9/00172 Lever 'L', non-locking, chrome

With 44 mm open-fixing

9/00173 Lever 'L', locking, chrome

9/00173/01 As above, FS 880

9/00183 Lever 'L', non-locking, chrome

SPECIFICATION

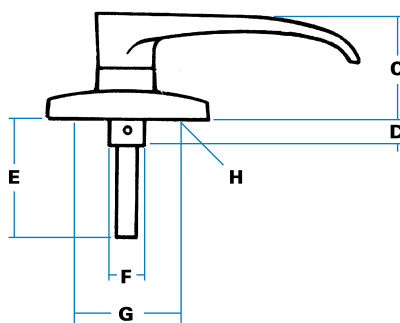
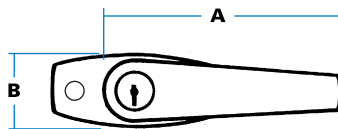

A	Handle length	115 mm
B	Mounting width	33 mm
C	Face height	42 mm
D	Depth of handle boss	10 mm
E	Shaft length	125 mm
F	Diameter of boss	14 mm
G	Hole centres	38/44 mm
H	Hole sizes (open) dia.	5 mm, c/s 9 mm

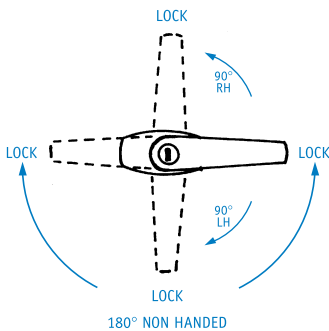

Handles operate through 180° as standard (non-handed). To special order, rotation can be limited to 90° LH (clockwise) or 90° RH (anticlockwise). Handles will lock at each 90° position.



180° as standard, rotation can be limited to 90°, LH/RH, or 360° free-movement.



Fix through countersunk holes, or with concealed-fixing models use screws provided (M4 x 8 mm) to secure from beneath. Neoprene gasket provided.



'FS' keys as standard with 'shuttered' keyway optionally 'FT' or 'DLP' key types.



Chromium plated or black powder coated



- Shaft lengths
- Threaded shafts (M10)
- Special key numbers/sets
- 90° LH/RH rotation
- Spring-return, LH/RH



Use with latching cams, slam latches or rod systems.

'plant-on'
fixing





SMALL 'T' HANDLES WITH SURFACE MOUNTING

Widely-used cabinet handles with rectangular, surface-mounted escutcheons for either open- or concealed-fixing.

Lock cylinders are "shuttered" for weather-resistance and there is choice of 38 mm (1.5 inch) or 44 mm (1.75 inch) hole centres.

9/00143
Non-locking small 'T'
38mm concealed fixing



9/00140
locking 'small T'
38mm open fixing



Single-sided 'FS' keys
are standard

ORDERING CODE

With 38 mm open-fixing

9/00140	Small 'T', locking, chrome
9/00140/01	As above, FS 880
9/00141	Small 'T', non-locking, chrome

With 38 mm concealed-fixing

9/00142	Small 'T', locking, chrome
9/00142/01	As above, FS 880
9/00143	Small 'T', non-locking, chrome

With 44 mm open-fixing

9/00240	Small 'T', locking, chrome
9/00240/01	As above, FS 880
9/00241	Small 'T', non-locking, chrome

SPECIFICATION

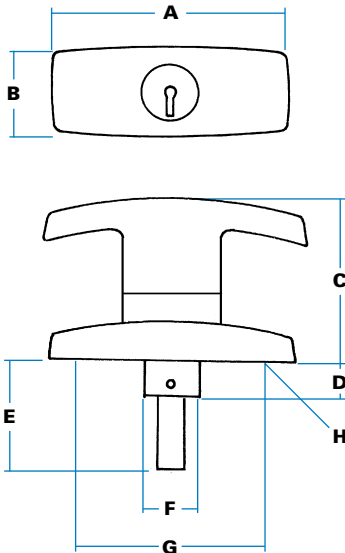

A	Handle length	65 mm
B	Mounting width	33 mm
C	Face height	42 mm
D	Depth of handle boss	10 mm
E	Shaft length	125 mm
F	Diameter of boss	14 mm
G	Hole centres	38/44 mm
H	Hole sizes (open) dia.	5 mm, c/s 9 mm

ROTATION OF HANDLES

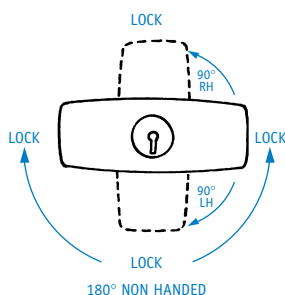

Handles operate through 180° as standard (non-handed). To special order, rotation can be limited to 90° LH (clockwise) or 90° RH (anticlockwise). Handles will lock at each 90° position.



180° as standard, rotation can be limited to 90°, LH/RH, or 360° free-movement.



Fix through countersunk holes, or with concealed-fixing models use screws provided (M4 x 8 mm) to secure from beneath. Neoprene gasket provided.



'FS' keys as standard with 'shuttered' keyway optionally 'FT' or 'DLP' key types.



Chromium plated or black powder coated



- Shaft lengths
- Threaded shafts (M10)
- Special key numbers/sets
- 90° LH/RH rotation
- Spring-return, LH/RH



Use with latching cams, slam latches or rod systems.

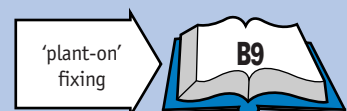



Single-sided 'FS' keys
are standard

9/00147
Non-locking Large 'T'
38mm concealed fixing



LARGE 'T' HANDLES WITH SURFACE MOUNTING

The most generally used
industrial handles, with
rectangular, surface-mounted
escutcheons for either open- or
concealed-fixing.

Lock cylinders are "shuttered" for
weather-resistance and there is choice
of 38 mm (1.5 inch) or 44 mm
(1.75 inch) hole centres.

ORDERING CODE

With 38 mm open-fixing

9/00144 Large 'T', locking, chrome

9/00144/01 As above, FS 880

9/00145 Large 'T', non-locking, chrome

With 38 mm concealed-fixing

9/00146 Large 'T', locking, chrome

9/00146/01 As above, FS 880

9/00147 Large 'T', non-locking, chrome

With 44 mm open-fixing

9/00244 Large 'T', locking, chrome

9/00244/01 As above, FS 880

9/00245 Large 'T', non-locking, chrome

SPECIFICATION

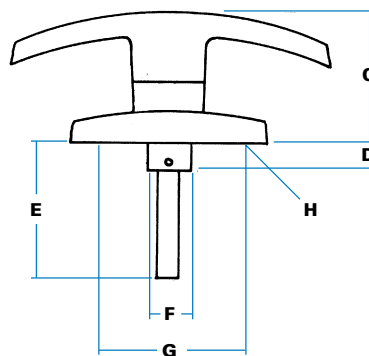
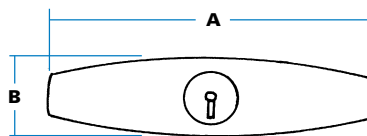

ROTATION OF HANDLES

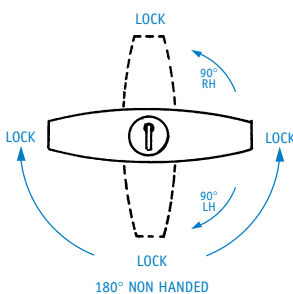

Handles operate through 180° as standard
(non-handed). To special order, rotation
can be limited to 90° LH (clockwise) or 90° RH
(anticlockwise). Handles will lock at each 90°
position.

A Handle length	100 mm
B Mounting width	33 mm
C Face height	42 mm
D Depth of handle boss	10 mm
E Shaft length	125 mm
F Diameter of boss	14 mm
G Hole centres	38/44 mm
H Hole sizes (open) dia.	5 mm, c/s 9 mm



180° as standard, rotation can be
limited to 90°, LH/RH, or 360° free-
movement.



Fix through countersunk holes, or with
concealed-fixing models use screws
provided (M4 x 8 mm) to secure from
beneath. Neoprene gasket provided.



'FS' keys as standard with 'shuttered'
keyway optionally 'FT' or 'DLP' key
types.



Chromium plated or black powder
coated



- Shaft lengths
- Threaded shafts (M10)
- Special key numbers/sets
- 90° LH/RH rotation
- Spring-return, LH/RH



Use with latching cams, slam latches or
rod systems.

'plant-on'
fixing



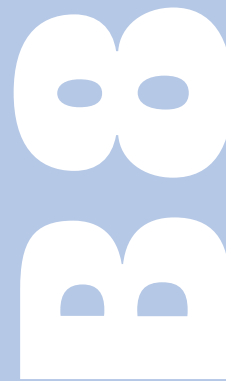

9/01369/70

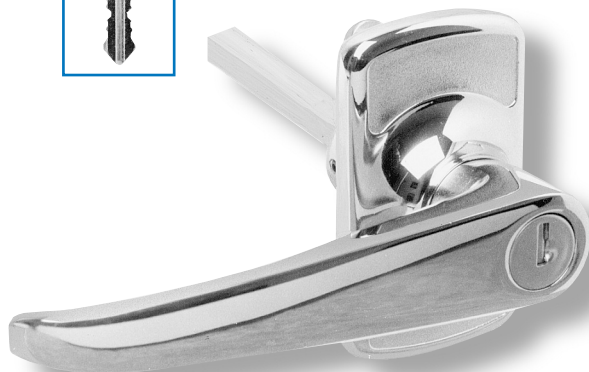

9/01184/85



Single-sided 'FS' keys
are standard

'PSV' MODELS (HANDLES WITH 90° 'LOST- MOTION' FITTING)

'Passenger Service Vehicle' requirements are that it must always be possible to open a door from inside, so that occupants cannot be trapped within a vehicle.

Our special 'PSV' bush meets this specification and can be fitted to most of our 'L' & 'T' handles. Those shown here have a special, large mounting escutcheon which has proved useful with this function.

ORDERING CODE

'L' Handles

9/01184 PSV 'L' handle, 90° LH

9/01185 PSV 'L' handle, 90° RH

'T' Handles

9/01369 PSV 'T' handle, 90° LH

9/01370 PSV 'T' handle, 90° RH

ROTATION OF HANDLES

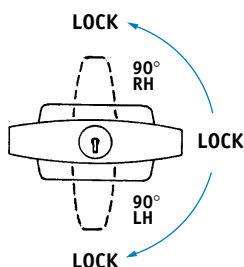

Handles operate through 90° LH/RH, locking in both positions, but PSV bush always allows shaft to be turned back 90° from inside.

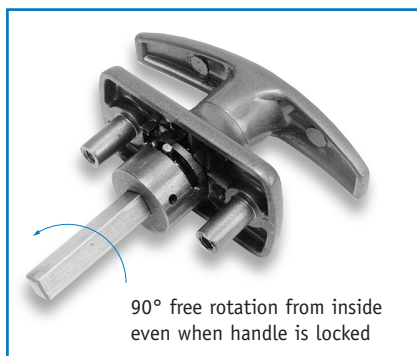

SPECIFICATION

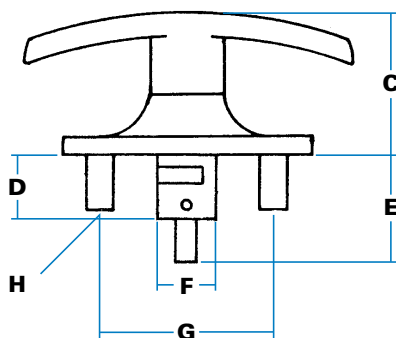
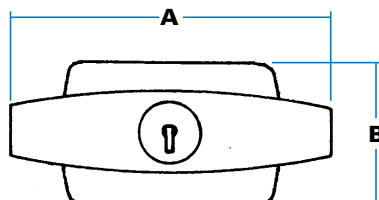

A Handle length	100 mm
B Mounting width	45 mm
C Surface height	41 mm
D Depth of PSV bush	22 mm
E Shaft length	65 mm
F Diameter of PSV bush	25 mm
G Holes Centres	75 mm
H Mounting Bosses, 18 mm deep x M6 Neoprene gasket & fixing bolts provided.	



Operate and lock handles as normal, but PSV bush always allows handle shaft to be turned back 90° from inside, to operate door latch.



LH & RH versions as shown. Bush can be set by hand to give 90° motion in desired direction.



Models shown are fixed from inside into two M6 tapped bosses. Neoprene gasket & fixing bolts provided.



'FS' keys as standard with 'shuttered' keyway, optionally 'FT' & 'DLP' key types.



Chromium plated or black powder coated.



PSV bush can be fitted to any handle apart from our 'traditional' designs, with special shafts to customer order.



Use with any slam latch system

2-Way
Systems

Section C



PLANT-ON 'L' HANDLES

Locking and non-locking, non-handed, with chromium-plated finish. Height 53 mm, all other dimensions as 9/00167 (B5).

ORDERING CODE

9/01667 Plant-on 'L', locking.

9/01667/01 As above, FS 880.

9/01670 Plant-on 'L', non-locking.



PLANT-ON 'SMALL T' HANDLES

Locking and non-locking, non-handed, with chromium-plated finish. Height 53 mm, all other dimensions as 9/00140 (B6).

ORDERING CODE

9/01660 Plant-on 'small T', locking.

9/01660/01 As above, FS 880.

9/01661 Plant-on 'small T', non-locking.



PLANT-ON 'LARGE T' HANDLES

Locking and non-locking, non-handed, with chromium-plated finish. Height 53 mm, all other dimensions as 9/00144 (B7).

ORDERING CODE

9/01664 Plant-on 'large T', locking.

9/01664/01 As above, FS 880.

9/01665 Plant-on 'large T', non-locking.

Single-sided 'FS' keys
are standard

**'L' & 'T' HANDLES
WITH FULLY
'PLANT-ON'
MOUNTING**

Identical to regular 'L' & 'T' models, but with a special high-waisted escutcheon that brings assembly fittings above panel surface, making handles fully 'plant-on'. Latch systems can be mounted immediately underneath, without need for bridging plate.

Note increased surface height (to 53 mm) and open-fixing at 38 mm (1.5 inch) centres only.



180° as standard, rotation can be limited to 90°, LH/RH, or 360° free-movement. Handles will lock in each 90° position.



Fix through countersunk holes at 38 mm centres only. Neoprene gasket provided.



'FS' keys as standard with 'shuttered' keyway, optionally 'FT' or 'DLP' key types.



Chromium plated or black powder coated



- Shaft lengths
- Threaded shafts (M10)
- Special key numbers/sets
- 90° LH/RH rotation



Use with latching cams, slam latches or rod systems.





1/24497
Locking Handle

ROTATION

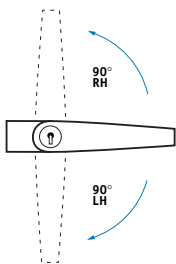

ORDERING CODE

90° RH rotation	
1/24497	Plant-on 'L', locking, chrome
1/24799	Plant-on 'L', non-locking, chrome
90° LH rotation	
1/24854	Plant-on 'L', locking, chrome
1/24809	Plant-on 'L', non-locking, chrome

SPECIFICATION

A	Handle length	105 mm
B	Mounting width	23 mm
C	Surface height	53 mm
D	Hole centres (fixing)	35 mm
	Holes tapped	10-32 UNF x 8 mm deep

**'PLANT-ON'
'L' & 'T' HANDLES
[OLDER-STYLE
MODELS]**

An older, special design but still popular because of the unusual shape of the handle castings, particularly the deep side-walls and the narrowness of the escutcheon. All fittings are contained above panel surface, making handles fully 'plant-on'. Non-locking models also available.



Single-sided 'FS' keys are standard



1/24517
Locking 'T' Handle

ROTATION

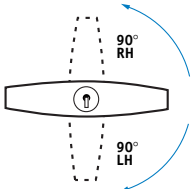

ORDERING CODE

90° RH rotation	
1/24517	Plant-on 'T', locking, chrome
1/24819	Plant-on 'T', non-locking, chrome
90° LH rotation	
1/24507	Plant-on 'T', locking, chrome
1/24829	Plant-on 'T', non-locking, chrome

SPECIFICATION

A	Handle length	100 mm
B	Mounting width	23 mm
C	Surface height	53 mm
D	Hole centres (fixing)	35 mm
	Holes tapped	10-32 UNF x 8 mm deep



Rotation is limited to 90° (clockwise) and 90° RH (anticlockwise) as shown, locking in both positions.



Concealed fixing only, by two screws into tapped bosses at 35 mm hole centres (1.375 inch). Gasket provided.



'FS' keys as standard with 'shuttered' keyway, optionally 'FT' or 'DLP' key types.



Chromium plated or black powder coated



- Shaft lengths
- Threaded shafts (M10)
- Special key numbers/sets

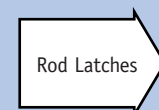

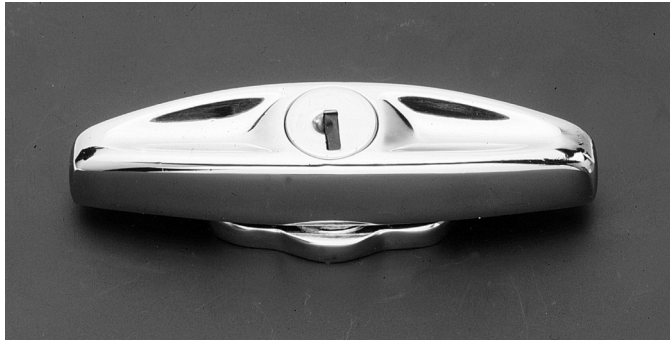

1/25515
'Lowline T' in 'Locked' position, (above)

Handle in 'open' position, (right), showing mounting holes on 'open fix' models.

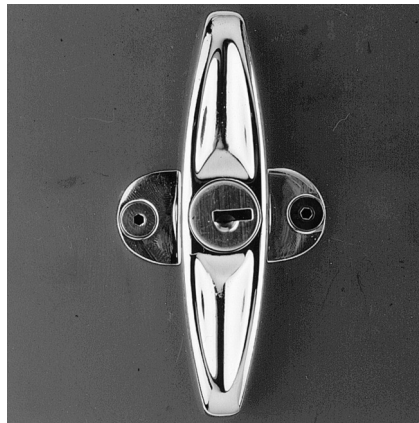

ORDERING CODE

With 40mm open-fixing

1/25515 'Lowline T', locking, chrome

1/25515/01 As above, FS880

1/25515B 'Lowline T', locking, black

1/25515B/01 As above, FS880

With 40mm concealed fixing

1/25517 'Lowline T', locking, chrome

1/25517/01 As above, FS880

1/25517B 'Lowline T', locking, black

1/25517B/01 As above, FS880

SPECIFICATION

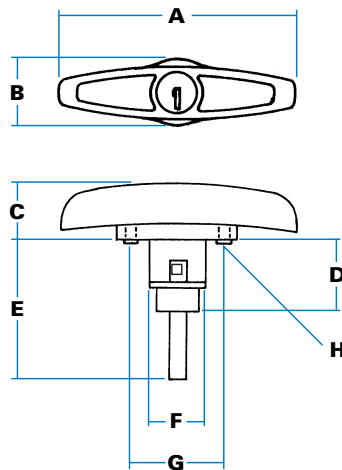

A Handle length	97 mm
B Mounting width	28 mm
C Face height	23 mm
D Depth of handle boss	25 mm
E Shaft length	76 mm
F Diameter of boss	23 mm
G Hole centres	40 mm
H Hole sizes (open) dia. 5mm c/s 9mm	

Concealed-fixing models have two threaded studs fitted into escutcheon, 10mm deep x 10-32 UNF. (Top face is plain).

ROTATION OF HANDLES

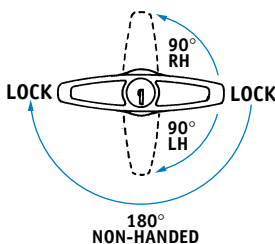

Handles operate through 180° as standard (non-handed). Rotation can be limited to 90° LH (clockwise) or 90° RH (anticlockwise). Handles will lock in horizontal position only.

'LOWLINE' MINIMAL-PROJECTION 'T' HANDLES

Sitting almost directly onto the panel surface, this design has absolutely minimum projection, avoiding risk of injury from the 'arms' of the T-handle.

With hidden mounting holes (or internal studs) it is ideal for roller shutters, vehicle side compartments and special cabinets.



180° as standard, rotation can be limited to 90°, LH/RH, or 360° free movement. Handle only locks in horizontal position.



Fix through countersunk holes (hidden when handle is locked), or with studs fitted to concealed-fixing models.



FS' keys as standard with 'shuttered' keyway, optionally 'FT', or 'DLP' key types.



Chromium plated or black powder coated.



- Shaft lengths
- Threaded shafts (M10)
- Special key numbers/sets
- 90° LH/RH rotation
- Fully-flush fitting using recess pan

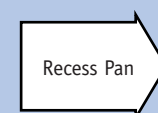



9/00400
'Open' Fixing



9/00402
'Concealed' Fixing

PADLOCKABLE HANDLES IN STAINLESS STEEL

Corrosion can be a major concern in some environments, such as marine industries or food processing plants, where these all-stainless handles will be very useful. The padlockable loop enables doors to be secured, with visible evidence that locking has taken place.

ORDERING CODE

9/00400 Padlockable handle, stainless steel, open-fixing

9/00402 Padlockable handle, stainless steel, concealed fixing

SPECIFICATION

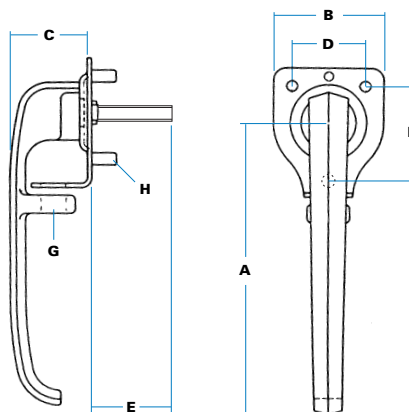

A Handle length	152 mm
B Mounting width	54 mm
C Face height	42 mm
D Hole centres	38 mm
E Shaft length	82 mm
F Hole centres	48 mm
G Padlock loop (dia)	12 mm
H {Holes sizes (dia) {Studs 13mm, 6mm x 20 UNC	5.5 mm

Concealed-fix models have 'O'-ring & gasket for sealing against dust/water ingress.

! Fully plant-on with either open or concealed fixing, bright polished 300 series stainless steel throughout. 'O'-ring & gasket with concealed-fix models.

↕ Free-rotation through 360°.

⚙ Fix through mounting holes in (open) escutcheon plate, or with studs on concealed fixing versions.

🔧 Bright polished on exterior surfaces.

M Handles constructed in 300 series stainless steel throughout.

? - Threaded shaft

Stainless
Budget
latches





9/01605
Stainless 'L' Handle with
WBH escutcheon & 8mm
shaft

9/01615
Stainless 'T' Handle with
WBH escutcheon & 8mm
shaft

STAINLESS STEEL HANDLES WITH 'EASY-FIX' MOUNTING

These 'L' and 'T' handles have similar dimensions to our diecast range, with the same 'easy-fix' mounting through a standard panel piercing. However, they are made completely in 300 series stainless steel for corrosion resistance and good appearance.

ORDERING CODE

With WBH Escutcheon & shaft
9/01605 Stainless 'L' handle

9/01615 Stainless 'T' handle

With WBH Escutcheon & latch bar
9/01600 Stainless 'L' handle

9/01610 Stainless 'T' handle

With 'EMKA' Escutcheon & shaft
9/01606 Stainless 'L' handle

9/01616 Stainless 'T' handle

With 'EMKA' Escutcheon & latch bar
9/01601 Stainless 'L' handle

9/01611 Stainless 'T' handle

SPECIFICATION

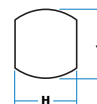
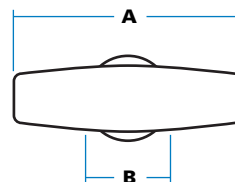
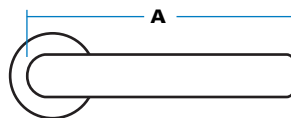

Panel-piercing
detail (WBH)

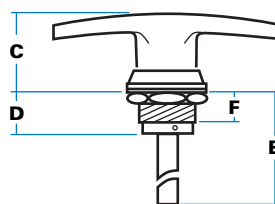

A Handle length ('L')	112 mm
A Handle length ('T')	80 mm
B Face width (escutcheon)	30 mm
C Face height	35 mm
D Body depth	18 mm
E Total projection (shaft length)	63 mm
F Depth of thread	10 mm
H Piercing across flats	22 mm
J Piercing, diameter	24 mm

Note: Dimensions of 'EMKA' escutcheon and panel piercing differ from above.



'T' handle with fitted latch bar
9/01610

'T' handle with fitted latch bar This model has a stainless latch bar (as 5/00097) with 10mm 'crank', fitted directly to the rear of the handle casting.

! Satin-finished handles with 8mm stainless steel shaft, or with directly-fitted latch bar. Fixing escutcheon to either WBH standard, or to fit 'EMKA/DIRAK' style piercings.

↕ 180° Movement against stops.

≡ Mount through panel piercing against 'flats' on escutcheon and secure with large stainless nut. Neoprene gasket and stainless spring spacing washer are provided.

🔧 Satin-finished as standard.

? - Shaft lengths
- Threaded shafts (M10)
- Semi-recess fitting for 'T' handles using 9/00138SS pan.

Stainless
Hinges

Section F



9/01279
Non-Locking
Handle

9/01280
Locking
Handle

Mounting holes at 44mm centres are totally hidden when handle is locked

'TITAN' SERIES HEAVY-DUTY HANDLES - 160mm LENGTH

Created to provide a robust, modern design, the 'Titan' series is much stronger than normal handles. In particular, metal section at the base of the handle casting is more than twice usual thickness, preventing fracture and resisting lateral loads.

! Large size, wide section for good grip, convenience of external mounting but with screws fully concealed when locked, double-sided keys as standard.

↕ 180° as standard, rotation can be limited to 90°, LH/RH, or to the special '180° horizontal' option. Handles lock at each 90° position.

🔩 Fix through countersunk holes at 44mm centres, which are completely hidden when handle is locked. Neoprene gasket supplied.

🔑 'FT' double-sided keys as standard with 'shuttered' keyway. Alternatively 'FS', or 'DLP' key types.

🔧 Black as standard, other finishes to special order only.

? - Shaft lengths
- Threaded shafts (M10)
- Special key numbers/sets
- 90° LH/RH rotation

ORDERING CODE

9/01280	'Titan' (160 mm) locking, black
9/01280/01	As above, FT111
9/01279	'Titan' (160 mm), non-locking, black

SPECIFICATION

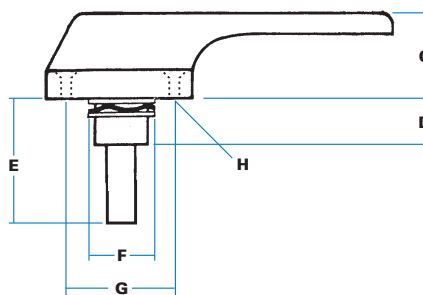
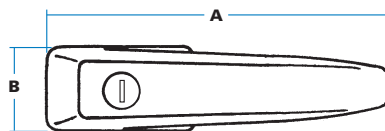

A Handle length	160 mm
B Mounting width	37 mm
C Face height	41 mm
D Depth of handle boss	18 mm
E Shaft length	130 mm
F Clearance	28 mm
G Hole centres	44 mm
H Hole sizes (open)	dia. 5.5 mm c/s 10 mm.

ROTATION OF HANDLES

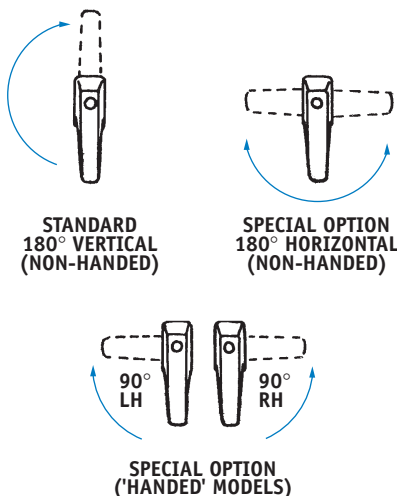

Handles operate through 180° as standard (non-handed). Rotation can be limited to 90° LH (clockwise) or 90° RH (anticlockwise), or to special order, to 180° horizontal movement as shown. Handles will lock in each 90° position.

Heavy-Duty
Cams

B22

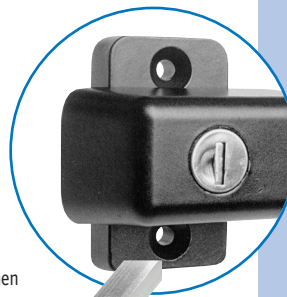

Mounting holes at 44mm centres are totally hidden when handle is locked

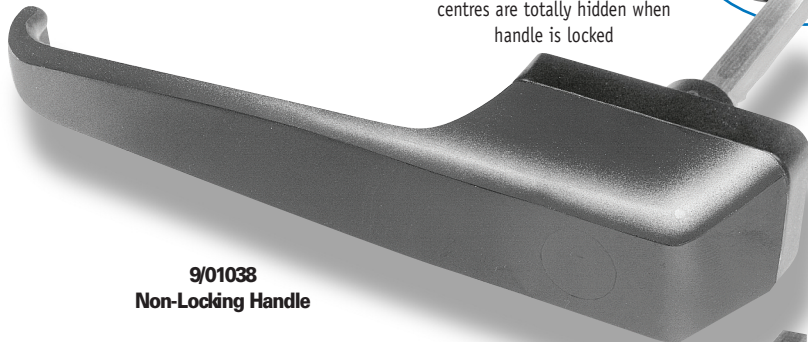

9/01038
Non-Locking Handle



9/01037
Locking Handle

'TITAN' SERIES HEAVY-DUTY HANDLES - 185mm LENGTH

The full-length versions of the 'Titan' series have 'tail' turned inwards for good appearance and to reduce surface projection. The metal section at the base of the handle casting is more than twice usual thickness, preventing fracture and resisting lateral loads.



Large size, wide section for good grip, convenience of external mounting but with screws fully concealed when locked, double-sided keys as standard.



180° as standard, rotation can be limited to 90°, LH/RH, or to the special '180° horizontal' option. Handles lock at each 90° position.



Fix through countersunk holes at 44mm centres, which are completely hidden when handle is locked. Neoprene gasket supplied.



'FT' double-sided keys as standard with 'shuttered' keyway. Alternatively 'FS', or 'DLP' key types.



Black as standard, other finishes to special order only.



- Shaft lengths
- Threaded shafts (M10)
- Special key numbers/sets
- 90° LH/RH rotation

ORDERING CODE

9/01037	'Titan' locking, black
9/01038	'Titan' non-locking, black
9/01035	'Titan' 90°LH non-locking, black
9/01036	'Titan' 90°RH non-locking, black
9/01071	'Titan' 90°LH, locking, black
9/01072	'Titan' 90°RH, locking, black

SPECIFICATION

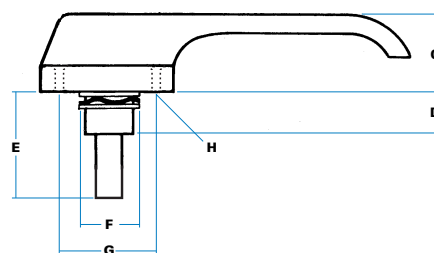
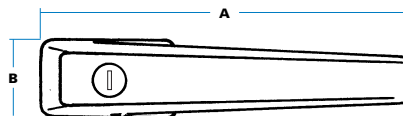

A	Handle length	185 mm
B	Mounting width	37 mm
C	Face height	41 mm
D	Depth of handle boss	18 mm
E	Shaft length	130 mm
F	Clearance	28 mm
G	Hole centres	44 mm
H	Hole sizes (open)	dia. 5.5 mm c/s 10 mm.

ROTATION OF HANDLES

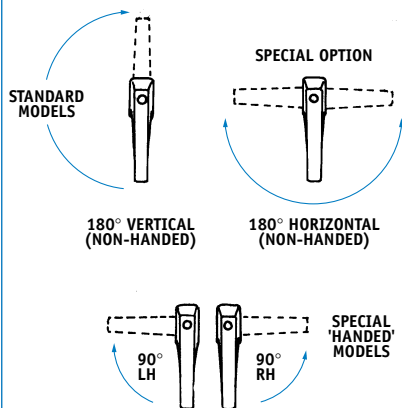

Handles operate through 180° as standard (non-handed). Rotation can be limited to 90° LH (clockwise) or 90° RH (anticlockwise), or to special order, to 180° horizontal movement as shown. Handles will lock in each 90° position.

Heavy-Duty
Cams

B22



9/01903
Non-locking handle



9/01902
Locking handle
with weathershield



Double-sided 'FT' Keys
are standard

'HEAVY-T' HANDLES WITH WEATHERSHIELD

An unusual locking handle with sliding 'weathershield' plate which completely protects lock cylinder against entry of water and road debris. Made with heavy-section castings and large, concealed-fixing escutcheon, this new design provides improved durability for vehicle applications. Non-locking version available.

ORDERING CODE

9/01902	'Heavy-T' handle, locking, chrome
9/01902/01	As above, FT111 keys, chrome
9/01903	'Heavy-T' handle, non-locking, chrome

SPECIFICATION

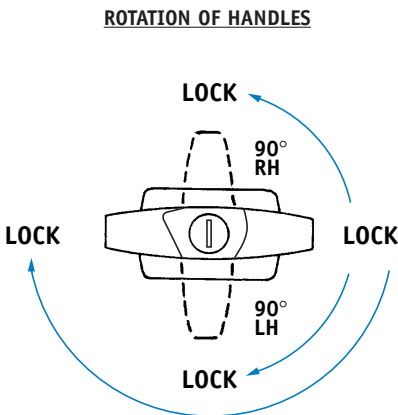
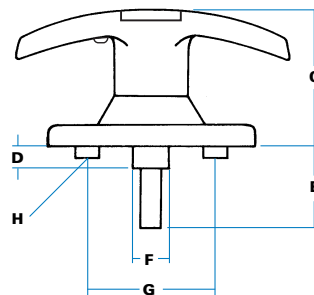
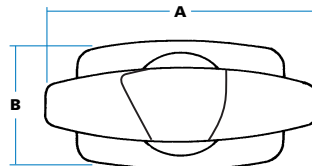

Handles operate through 180° as standard (non-handed). To special order, rotation can be limited to 90° LH (clockwise) or 90° RH (anticlockwise). Handles will lock at each 90° position.

A Handle length	110 mm
B Mounting width	51 mm
C Face height	53 mm
D Depth of handle boss	10 mm
E Shaft length	63 mm
F Diameter of boss	25 mm
G Hole centres	51 mm
H Bosses, 3mm high, tapped M6 x 7mm	

Handle supplied with fixing bolts (MP00129) and neoprene gasket.



Lift 'weathershield' to insert key. Movement is 180° as standard, rotation can be limited to 90° RH/LH when required.



Concealed-fixing into two tapped bosses, using M6 bolts and neoprene gasket provided. Handle must be fitted with weathershield sliding upwards to reveal keyway.



'FT' double-sided keys as standard with 'shuttered' keyway. Optionally 'FS' or 'DLP' key types.



Exterior-grade chromium plating as standard.



- Shaft lengths
- Threaded shafts
- Special key numbers/sets
- 90° LH/RH rotation
- 'PSV' fitting

Heavy Duty
Cams





Single-sided 'FS' keys only

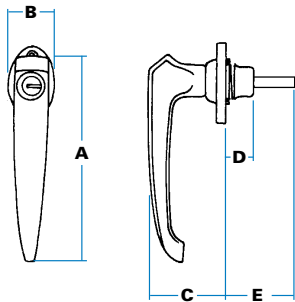

1/04964
'Heavyweight'
Non-Locking Handle



1/04959
'Heavyweight' Locking
Handle

ORDERING CODE

1/04959	'Heavyweight' handle, locking, chrome
1/04959/01	As above, FS880
1/04964	'Heavyweight' handle, non locking, chrome
	Add suffix 'B' for black.

SPECIFICATION

A Handle length	160 mm
B Mounting width	32 mm
C Face height	60 mm
D Depth of handle boss	20 mm
E Shaft length	140 mm
Fixing centres at 44mm (1.75 inch) only.	



Single-sided 'FS' keys only

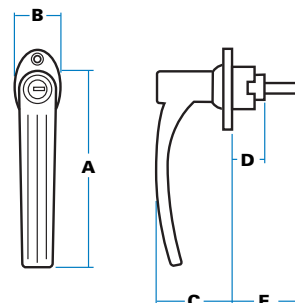

1/30327
'Ribbed'
Locking Handle



ORDERING CODE

1/11465	'Ribbed' handle, locking, chrome
1/18259	'Ribbed' handle, non-locking, chrome
With spring-return at 38mm centres	
1/30327	Locking handle, 90° LH, black
1/30328	Locking handle, 90° RH, black

SPECIFICATION

A Handle length	150 mm
B Mounting width	32 mm
C Face height	56 mm
D Depth of handle boss	20 mm
E Shaft length	140 mm
Fixing centres at 44mm for standard models. Dimensions vary slightly for spring-return handles with 38mm centres.	

'TRADITIONAL' HANDLES - HEAVY-DUTY MODELS

Two of our older designs, both made for large trucks, with heavier-duty fittings and extra metal thickness around shaft-retaining area to give greater strength.

The 'Heavyweight' series (at 504 grams) has been used by Massey Ferguson, Fodens, Scammel, and many American truck models. Fixing centres at 44mm (1.75 inch) only.

The 'Ribbed' series has been used by Bedford and military trucks, and by Ford Tractors. Fixing centres at 44mm (1.75 inch), or with spring return at 38mm (1.5 inch) centres.



Free rotation through 360°, locking at each 90° position. Spring-return models travel through 90° only.



Fix through countersunk holes. Neoprene gaskets provided.



'FS' keys only, with 'shuttered' keyway.



Chromium plated or black powder-coated.



- Shaft lengths
- Threaded shafts (M10)
- Special key numbers/sets
- 'Customised' keys





Single-sided 'FS' keys are standard



1/16600
Non-Locking Handle



1/12950
Locking Handle

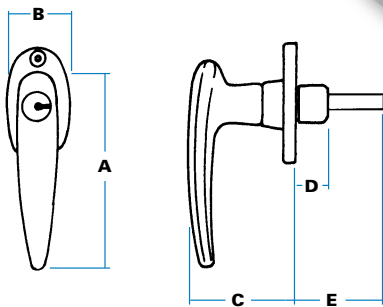

ORDERING CODE

1/12950	Locking handle, chrome (44mm)
1/12950/01	As above, FS880
1/16600	Non-locking handle, chrome (44mm)
1/28892	Locking handle, chrome (38mm)
1/28892/01	As above, FS880
1/16686	Non-locking handle, chrome (38mm)

Add suffix 'B' for black.

SPECIFICATION

A	Handle length	105 mm
B	Mounting width	32 mm
C	Face height	50 mm
D	Depth of handle boss	16 mm
E	Shaft length	125 mm

Fixing centres at 38mm & 44mm, standard.

'TRADITIONAL' HANDLES ALL-PURPOSE MODELS

These familiar designs have been fitted at various times to passenger cars, trucks, tractors, and to all types of ancillary equipment. Standard fixing centres 38mm (1.5 inch) and 44mm (1.75 inch), with alternative mounting escutcheons available, including concealed-fix options.

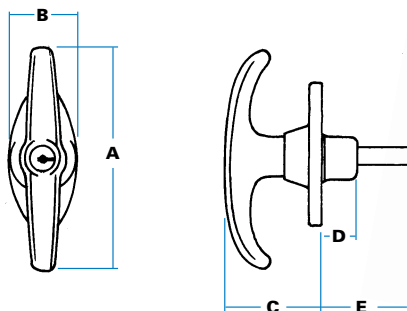

1/13400
Locking 'T' Handle

ORDERING CODE

1/13400	Locking 'T', chrome, (44mm)
1/13400/01	As above, FS880
1/15400	Non-locking 'T', chrome (44mm)
1/13482	Locking 'T', chrome (38mm)
1/13482/01	As above, FS880
1/15402	Non-locking 'T', chrome (38mm)

SPECIFICATION

A	Handle length	105 mm
B	Mounting width	32 mm
C	Face height	50 mm
D	Depth of handle boss	16 mm
E	Shaft length	125 mm

Fixing centres at 38mm & 44mm, standard.



Free rotation through 360°, locking at each 90° position.



Fix through countersunk holes or with studs on concealed-fixing versions. Neoprene gaskets provided.



FS' keys only, with shuttered keyway.



Chromium plated or black powder-coated.



- Shaft lengths
- Threaded shafts
- Special key numbers/sets
- 'Customised' keys
- Alternative mounting escutcheons



Single-sided 'FS' keys only



1/14300
'Arched' Locking Handle

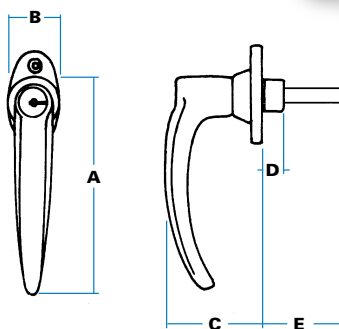

ORDERING CODE

1/14300	'Arched' handle, locking, chrome (44mm)
1/14300/01	As above, FS880
1/14600	'Arched' handle, non-locking, chrome (44mm)
1/28902	'Arched' handle, locking, chrome (38mm)
1/28902/01	As above, FS880
1/28903	'Arched' handle, non-locking, chrome (38mm)

SPECIFICATION

A	Handle length	130 mm
B	Mounting width	32 mm
C	Face height	56 mm
D	Depth of handle boss	16 mm
E	Shaft length	125 mm

Fixing centres at 38mm & 44mm, standard.

'TRADITIONAL' HANDLES 'ARCHED' & 'SMALL-L'

Two other long-established designs, both have unusual lengths of 'lever' which make them suitable for special vehicle applications and for 'kit' and 'replicars'. Standard models are as shown, with alternative mounting escutcheons available, including concealed-fix options

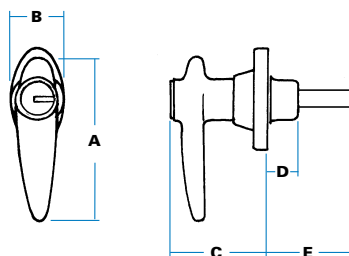

1/13700
'Small L' Locking Handle

ORDERING CODE

1/13700	'Small L', locking, chrome (35mm)
1/13700/01	As above, FS880
1/18140	'Small L', non-locking, chrome (35mm)

SPECIFICATION

A	Handle length	74 mm
B	Mounting width	30 mm
C	Face height	43 mm
D	Depth of handle boss	16 mm
E	Shaft length	125 mm

Fixing centres are 35mm (1.37 inch), standard.



Free rotation through 360°, locking at each 90° position.



Fix through countersunk holes or with studs on concealed-fixing versions. Neoprene gaskets provided.



FS' keys only, with shuttered keyway.



Chromium plated or black powder-coated.



- Shaft lengths
- Threaded shafts
- Special key numbers/sets
- 'Customised' keys
- Alternative mounting escutcheons
- Concealed fixing at 36mm & 40mm centres



Single-sided 'FS' keys only

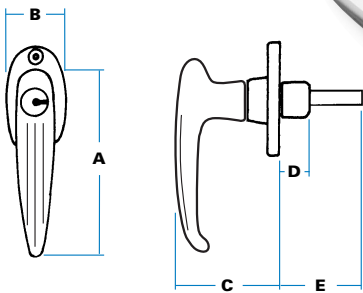

1/15134
'Fluted'
Non-Locking handle



1/12734
'Fluted'
Locking handle



ORDERING CODE

1/12734	'Fluted' handle, locking, chrome (44 mm)
1/12734/01	As above, FS880
1/15134	'Fluted' handle, non-locking, chrome (44 mm)
1/12700	'Fluted' handle, locking, chrome (36 mm)
1/15100	'Fluted' handle, non-locking, chrome (36 mm)

SPECIFICATION

A	Handle length	100 mm
B	Mounting width	32 mm
C	Face height	51 mm
D	Depth of handle boss	16 mm
E	Shaft length	125 mm

Fixing centres at 44 mm & 36 mm, standard.

'TRADITIONAL' HANDLES - CLASSIC 'PERIOD' MODELS

At one time immensely popular, these handles are now mostly used for restorations and reproductions of classic vehicles. Standard fixing centres are 44mm (1.75 inch) & 36mm (1.43 inch), with alternative mounting escutcheons available, including concealed-fix options.

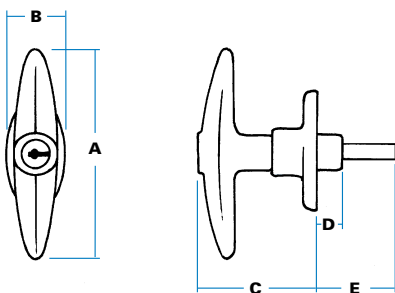

ORDERING CODE

1/16131	Locking 'T' handle, chrome (44 mm)
1/16131/01	As above, FS880
1/16132	'Non-locking 'T' handle, chrome (44 mm)
1/16100	Locking 'T' handle, chrome (36 mm)
1/16050	Non-locking 'T' handle, chrome (36 mm)

1/16100
Locking 'T' Handle



SPECIFICATION

A	Handle length	108 mm
B	Mounting width	32 mm
C	Face height	51 mm
D	Depth of handle boss	16 mm
E	Shaft length	125 mm

Fixing centres are 44 mm & 36 mm standard.



Free rotation through 360°, locking at each 90° position.



Fix through countersunk holes or with studs on concealed-fixing versions. Neoprene gaskets provided.



'FS' keys only, with 'shuttered' keyway.



Chromium plated or black powder-coated.



- Shaft lengths
- Threaded shafts
- Special key numbers/sets
- Alternative mounting escutcheons
- Concealed fixing at 36 mm & 40 mm centres.



Single-sided 'FS' keys are standard

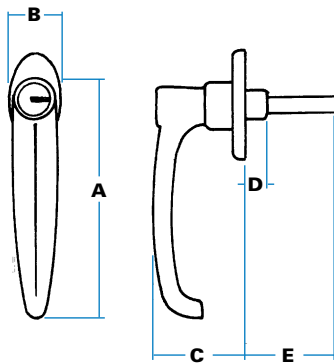

1/27251
Locking 'L' Handle
Safety style

ORDERING CODE

1/27251	'Safety' handle, locking, chrome (44 mm)
1/27251/01	As above, FS880
1/27252	'Safety' handle, non-locking, chrome (44 mm)

SPECIFICATION

A	Handle length	130 mm
B	Mounting width	32 mm
C	Face height	42 mm
D	Depth of handle boss	16 mm
E	Shaft length	125 mm

Fixing centres at 44 mm standard.

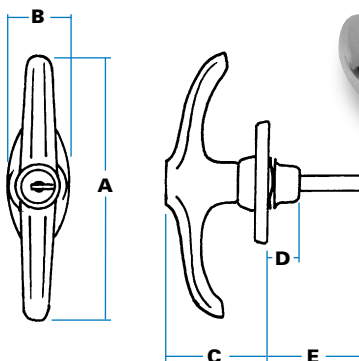

1/00831
Locking 'T' Handle
Safety style

ORDERING CODE

1/00831	Locking 'T' handle, chrome (44 mm)
1/00831/01	As above, FS880
1/00832	'Non-locking 'T' handle, chrome (44 mm)

SPECIFICATION

A	Handle length	135 mm
B	Mounting width	32 mm
C	Face height	51 mm
D	Depth of handle boss	16 mm
E	Shaft length	125 mm

Fixing centres are 44 mm standard.

'TRADITIONAL' HANDLES - STYLED FOR SAFETY

Both of these handles have been designed so that the 'arms' turn under and down, to avoid a sharp, projecting tip. With relatively long, heavy-section castings they are well suited to specialist vehicles, particularly if mounting panel is shaped and brought up close to the ends of the handles.



Free rotation through 360°, locking at each 90° position.



Fix through countersunk holes or with studs on concealed-fixing versions.



'FS' keys only, with 'shuttered' keyway, ('FT' keys option on 'L' handle).



Chromium plated or black powder-coated.



- Shaft lengths
- Threaded shafts
- Special key numbers/sets
- Alternative mounting escutcheons
- Concealed fixing at 36 mm & 40 mm centres



1/27296
Small cam



9/00837
Large cam

ORDERING CODE

1/27296	Small cam, 8 mm square hole
1/27297	Small cam, M8 threaded hole
9/00837	Large cam, 8 mm square hole

SPECIFICATION

A	Length (small cam)	32 mm
A1	Length (large cam)	63 mm
B	Width	40 mm
C	Location	11 mm
D	Diameter	19 mm
E	Height	13 mm
F	Cam-form	4 mm

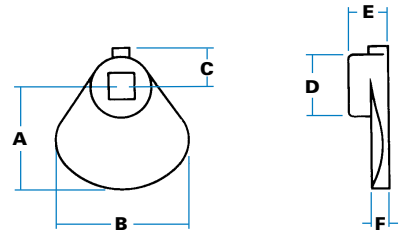

All cams are fitted with hexagon-head grub screw, adjusted by 3/32" Allen key (threaded 10/32 UNF x 3/8")

DIECAST CAMS & HEAVY-DUTY LATCH BARS

Our diecast cams provide the simplest way of securing an enclosure door. They fit onto a plain, 8 mm-square shaft, and are clamped into position with the integral socket screw. A version is available with hole threaded M8, to suit corresponding round shaft.

Heavy-duty latch bars, made in rolled-edge mild steel, 30 mm width x 5 mm deep, with 3 mm 'V' raise for cam-action.



5/02071
'cranked up'

5/02069
'straight'

5/02067
'cranked down'

5/02059
'hooked'

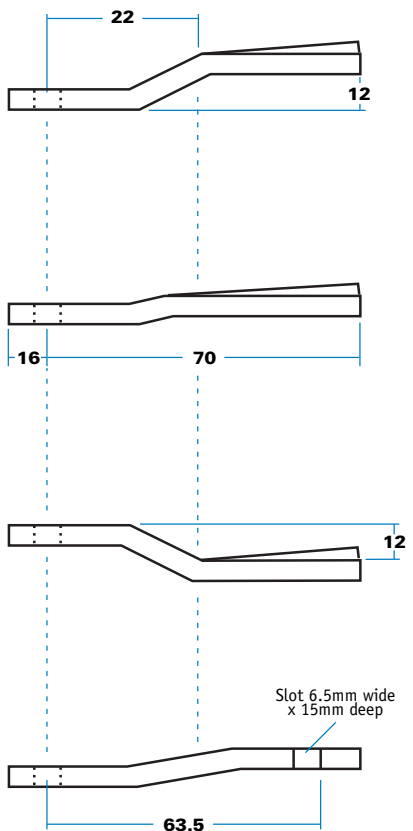

The range of heavy steel cams (below) is normally fitted to our 'drop-T' series, but they can be used with any 8 mm-square shaft, normally threaded M10 with securing nuts to allow for adjustment and retention. Finish is bright zinc-plated.





9/01900
Locking Handle

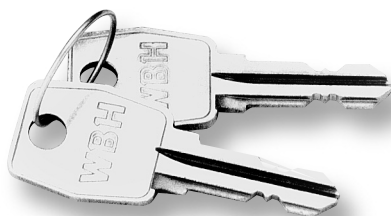

Double-sided 'FT' Keys are
fitted as standard

ORDERING CODE

9/01900 Push-button handle, 'FT' locking

9/01900/01 Push-button handle, 'FT111' keys

9/01901 Push-button handle, non-locking

SPECIFICATION

A Length	183 mm
B Width (max)	47 mm
C Height	36 mm
D Projection (rest)	32 mm
E Diameter	28 mm
F Hole centres	120 mm
G Hole centres	18 mm
H Holes	M6 x 10 mm
J Grip height	28 mm
K Travel (vertical)	14 mm
L Travel (locking)	22 mm

Materials

Handle moulding in 30% glass filled acetal copolymer. Button in zinc alloy diecast, chromium plated. Contactor in steel, zinc plated.

Alternative Contactors:

See page A10 for latch-push dimensions and alternatives.

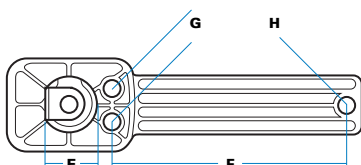
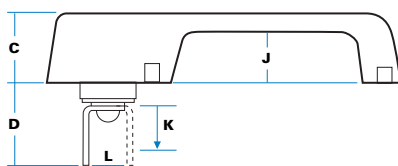
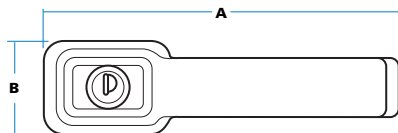

PUSH-BUTTON HANDLE

An attractively styled handle, suitable for all personnel and compartment doors, and moulded in impact-resistant material with textured finish. This is a 'free wheeling' design, so the handle can never be forced when the button is in the locked position.



Moulded push-button handle with diecast button and lock cylinder, providing good grip for gloved hand.



Steel contactor travels 14mm downwards when button is depressed. When locked, contactor cam rotates 180° out-of-position to disengage from the latch mechanism.



Fixing beneath into three brass inserts, threaded M6 x 10mm deep, gaskets provided.



Fitted with double-sided 'FT' keys. Can also be supplied with 'FS', '92' or DLP key styles.



Finish is self-colour black textured surface, bright chrome button.



Special options include supply as pairs or sets, standard key number (FT111) or alternative contactor plates.



Moulded in 30% mineral-filled polyethylene



This handle is a direct alternative to Happich/DLP 580-0183 and Jagger 9300



**'FT' Keys
Optional**



1/22788
'High-grip' handle

ORDERING CODE

1/22788	High-grip handle, locking, chrome
1/22788/01	As above, FS880
1/22789	High-grip handle, non-locking, chrome

SPECIFICATION

A Length	175 mm
B Width (max)	33 mm
C Height (max)	52 mm
D Projection	15 mm
F Hole centres	120 mm
G Hole centres	16 mm
H Hole sizes	M6 x 19 mm
J Grip height	35 mm
K Travel (vertical)	15 mm

An adjustment nut allows simple, on-site control of depth of travel of plunger screw.

DIECAST PUSH-BUTTON HANDLES

These two handles are 'blocked-action' models, so that when key is turned to lock, the button cannot be depressed.

The 'high-grip' design is essentially plant-on, with plunger operating through a good depth of travel. It suits tractors and commercial vehicles.

The 'classic' model has much lower projection but fits a flat panel and is widely used by 'kit' and specialist car builders.

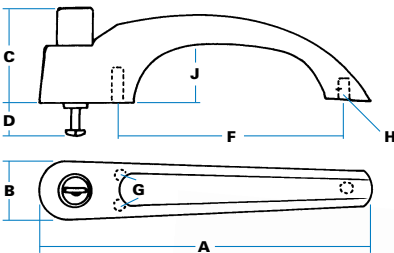

1/07986
'Classic' push-button handle



ORDERING CODE

1/07986	Classic handle, locking, chrome
1/07987	Classic handle, non-locking, chrome
1/07988	As 1/07986, paired

SPECIFICATION

A Length	158 mm
B Width	30 mm
C Height (max)	35 mm
D Projection (rest)	12 mm
E Diameter	24 mm
F Hole centres	145 mm
H Hole sizes	1/4 BSF x 10 mm
J Grip height	19 mm
K Travel (vertical)	8 mm

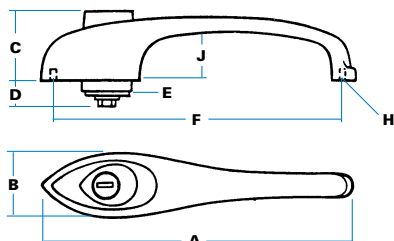

Button operates vertical plunger, which is locked by turning key through 90°. Keys withdraw in 'open' & 'locked' positions.



Both fixed from beneath into tapped holes. The 'classic' model requires panel cut-out.



Chromium plated, or black powder coated handle with chrome button.



'FS' as standard with 'shuttered' keyway, optionally 'FT', '92' or 'DLP' key types. Non-locking models.



- Extended plungers
- Special key numbers/sets



Use with push-action latches, such as 'disc' latches 3/22142, etc.



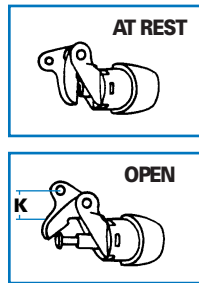

1/24468 (LH)
'Limo' handle with fitted bell-crank

ORDERING CODE

1/24467 'Limo' handle, RH, chrome

1/24468 'Limo' handle, LH, chrome

1/24466 'Limo' handles, Pair, chrome

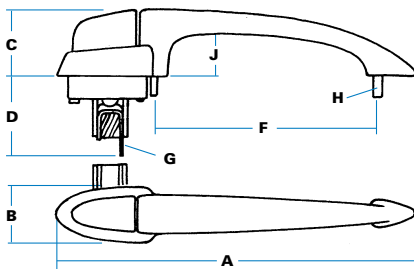

Illustration shows 1/24467, right-hand handle, with bell-crank operating upwards.

SPECIFICATION

A Length	187 mm
B Width (max)	25 mm
C Height (max)	35 mm
D Projection	45 mm
F Hole centres	117 mm
G Contactor hole	dia. 5 mm
H Studs (2)	10-32 UNF x 15 mm
J Grip height	30 mm
K Travel (horizontal)	45 mm

Note: Plunger screw allows adjustment of travel, position of bracket (up/down) determines 'handing'. Connecting clips (3/13390) and linkage rod (9/00078).

PUSH-BUTTON HANDLES FOR SEPARATE 'PRIVATE' LOCKS

These two diecast handles both require 'private' locks to be mounted separately on the door panel.

The 'bell-crank' design translates vertical movement into lateral 'pull', allowing handles to be fitted some distance away from latch mechanisms. They have been used on Jaguar, Triumph & Aston Martin cars.

The 'sports' models are simple, direct-action handles which must be mounted over the latch push-plate. They have been used on MG, Triumph and Panther cars.

Separate 'private' locks are required

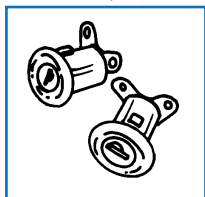

9/00210
'Sports' handle

ORDERING CODE

9/00210 'Sports' handle, chrome, long stem

9/00212 'Sports' handle, chrome, short stem

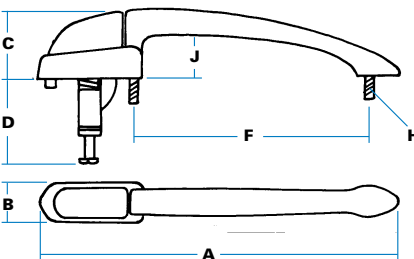

Illustration shows 9/00210, with 'long stem' and plunger support bracket.

SPECIFICATION

A Length	178 mm
B Width (max)	20 mm
C Height (max)	35 mm
D Projection	32 mm
F Mounting centres	117 mm
H Studs	10-32 UNF x 10 mm
J Grip height	23 mm
K Travel (vertical)	12 mm

Note: Plunger screw allows adjustment of travel. With 'short stem' model, projection 'D' is 8 mm.



Both are essentially plant-on, fixed from beneath with tapped holes and studs. Both require cut-outs for inside plunger details..



Chromium plated, or black powder coated.



- For 'bell-crank' handles use 'linkage-type' disc latches (3/15298-99) see D20
- For 'sports' handles use 'push-button' disc latches, (3/30476/7), see D21
- For 'private' door locks, (1/29400-1), see A9
- For inside releases, see E1-8

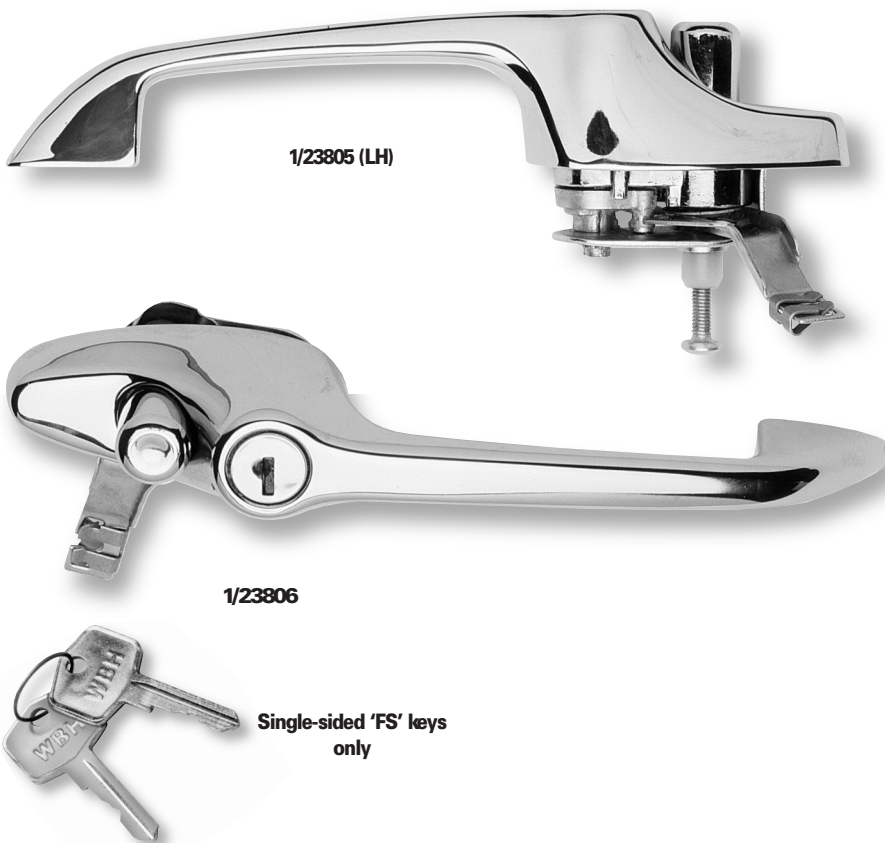

PUSH-BUTTON HANDLES FOR INTERCONNECTED DOOR SCHEMES

Designed for the famous 'Mini' these elegant handles have been used for a number of other passenger cars and light commercial vehicles. They are intended for use with our 'disc' latches (see opposite) but can be adapted to suit other latch models.

ORDERING CODE

1/23805	Push-button handle, LH, chrome
1/23805B	Push-button handle, LH, black
1/23806	Push-button handle, RH, chrome
1/23806B	Push-button handle, RH, black
9/01062	Paired handles, chrome
9/01062B	Paired handles, black

Lever-end has spring-clip for 'push-on' engagement with 3.5 mm diameter operating rod on disc latch.

SPECIFICATION

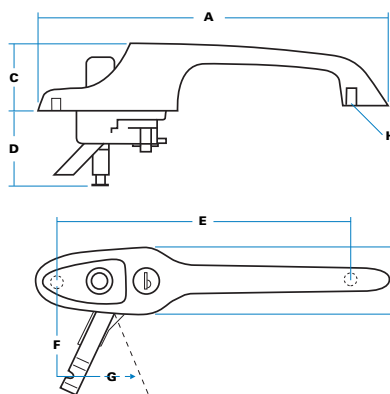

A Total length	190 mm
B Width (max)	33 mm
C Height (max)	35 mm
D Plunger depth (rest)	28 mm
	(extended) 44 mm
E Hole centres	160 mm
F Lever position ('locked')	45 mm
G Lever travel	45 mm
H Hole sizes	10-32UNF x 10 mm



Handle allows full interconnection of lock/latching functions, through body of latch to inside release.



When key is turned to locked position, button is 'blocked' and cannot be depressed. This also causes attached lever to travel through 'G' and operate the locking function within the door latch. Thus even if button is forced, latch will still not open. Adjustment feature on plunger. 'Lost-motion' allows door to be opened from inside even when handle is locked.



Fixed from beneath into two tapped holes. Cut-out required for inside plunger detail.



'FS' keys only with 'shuttered' keyway.



Chromium-plated or black powder-coated.



- Special key numbers/sets
- 'Customised' keys



- Use with disc latches 3/30476-7 (see opposite)

INSTALLATION SCHEME

These handles and latches have been used for volume, on-road cars and vans over many years. The schemes allow **full interconnection** between inside and outside, with a 'locking' feature built into the latch. It is the vehicle manufacturer's responsibility to test and certify a fitted scheme.

Right-Side Door Illustrated

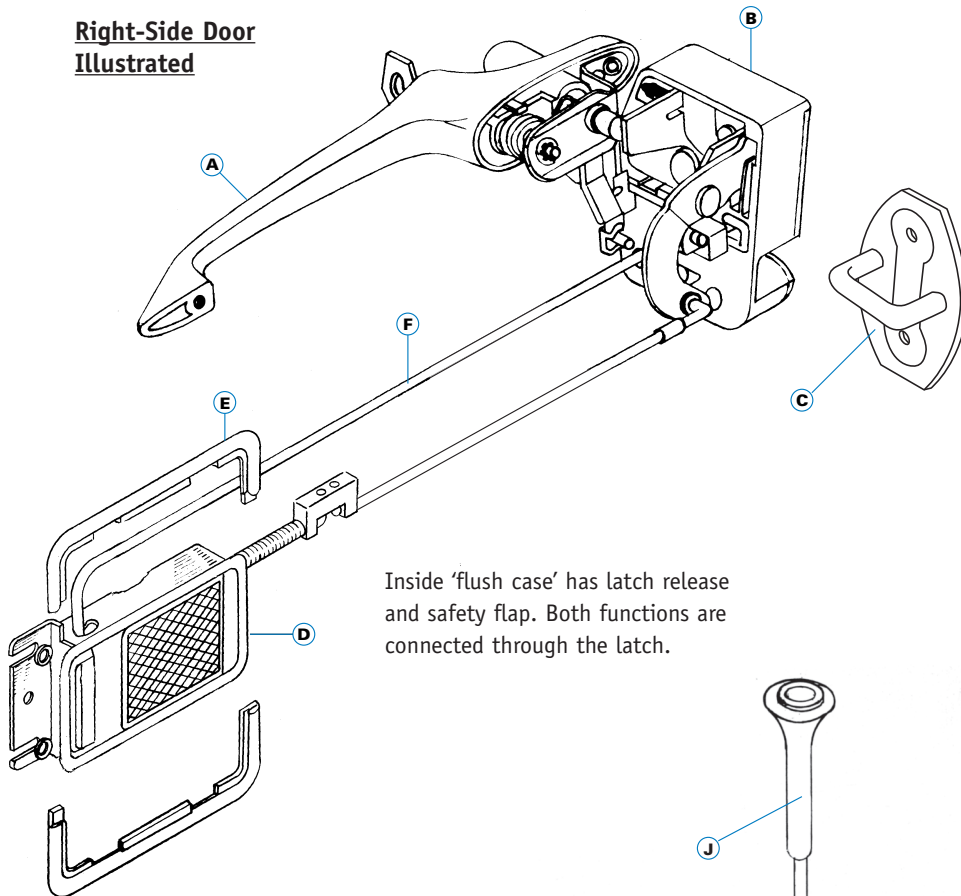

Inside 'flush case' has latch release and safety flap. Both functions are connected through the latch.

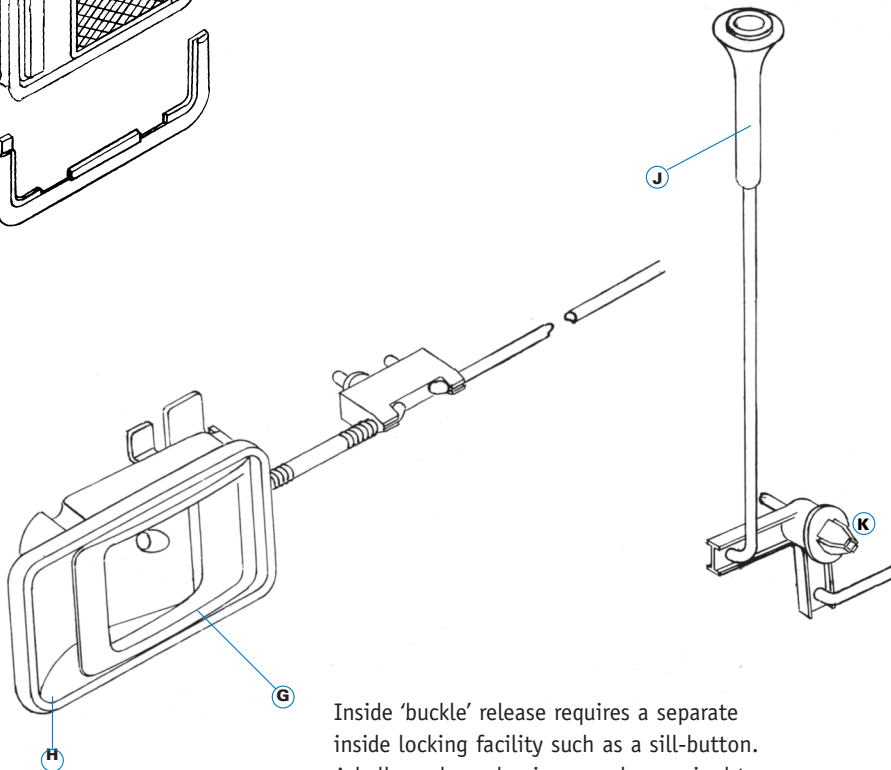

Inside 'buckle' release requires a separate inside locking facility such as a sill-button. A bell-crank mechanism may be required to convert vertical to horizontal motion

PUSH-BUTTON HANDLES - INSTALLATION SCHEMES

Handles allow fully interconnected inside and outside locking/latching, and these schemes will suit on-road passenger doors. Other items are described fully on the pages indicated.

Scheme with 'flush cases'

Items illustrated:

- A 1/23806 Outside handle, RH
- B 3/30476 Disc latch, RH
- C 3/21330 Plant-on striker
- D 1/29774 Flush-case, black, RH
- E 3/14422 Trim bezels, black
- F 9/00078 Connector rod

Scheme with 'buckle' release

Items illustrated:

- G 1/29908 'Buckle' release, chrome
- H 3/22324 Trim-bowl, black
- J 7/26668 Sill-button
- K 831398-9 Bell-crank assembly





Double-sided 'FT'
keys only



1/25654 (Right-hand)
The connecting link between
'lock' and 'latch' points 'X'
& 'Y' can be clearly seen.

DIECAST FLUSH 'FLAP' HANDLES

A sophisticated design, the 'Flap' handle is easy to fit and is widely used on all types of on-road vehicles. There are two modes of operation, either as a fully self-contained "freewheeling" handle, or with separate "isolated" lock and latch connection points.

ORDERING CODE

'Freewheel' handles

1/25654	Flap handle, RH, black & chrome
1/25654B	As above, all -black
1/25653	Flap handle, LH, black & chrome
1/25653B	As above, all-black
1/25673	Flap handles, pair, black & chrome
1/25673B	As above, all-black

'Isolated' handles

1/29344	Flap handle, RH, black & chrome
1/29344B	As above, all black
1/29345	Flap handle, LH, black & chrome
1/29345B	As above, all black
1/29346	Flap handles, pair, black & chrome
1/29346B	As above, all black

INSIDE VIEW OF HANDLE (LH)

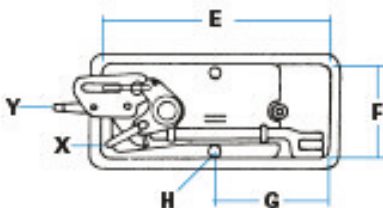

Studs are mounted in diecast bosses to clear operating plunger. Inside rim width is 6 mm. Recommended cut-out size 57 mm x 135 mm. Gasket rim width is 8 mm.

SPECIFICATION

RIGHT-HAND HANDLE ILLUSTRATED

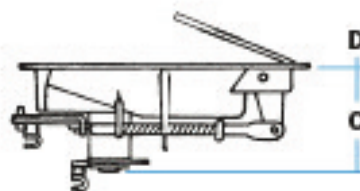
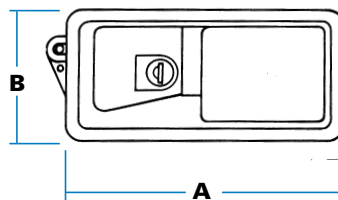

A	Case length	145 mm
B	Case width	67 mm
C	Maximum depth	50 mm
D	Maximum flap height	32 mm
E	Inside length	133 mm
F	Inside width	55 mm
G	Location to studs	65 mm
H	Studs	10-32 UNF x 10 mm
X	Maximum travel of locking point when key is rotated	18 mm
Y	Maximum travel of latching point when flap is lifted	15 mm



With "Freewheeling" model, action of the key cylinder disengages latch release via connecting link. With "isolated" model, key cylinder must be connected separately to a suitable latch.



Turn key and lift flap to rotate connection points 'X' and 'Y'. The lock cylinder has 'private lock' movement with 45° 'lost motion'.



Handle is fitted from outside into panel cut-out and is secured against two threaded studs, (nuts supplied) using 'U'-bracket or inner structural member. A moulded gasket is provided.



Double-sided 'FT' keys only.



Black case and chromium-plated flap with 'stippled' finish: alternatively, all black.



Special key numbers/sets
'Customised' keys
Colour finishes (volume permitting)

INSTALLATION SCHEME - A - "AMERICAN" PRACTICE

With scheme 'A', locking takes place within the outside handle, allowing a relatively simple latch to be used. This system is popular for Recreational Vehicles and small trucks.

Typical door layout using 'Freewheeling' handle with linked/latch functions.

Right-Side Door Illustrated

To achieve the correct movements, outside handles must be reverse-mounted. Thus the normal 'LH' handle is used for right-side door fitting.

Inside "Flush-case" has latch release only, with no safety flap. As an alternative use our "Buckle" design.

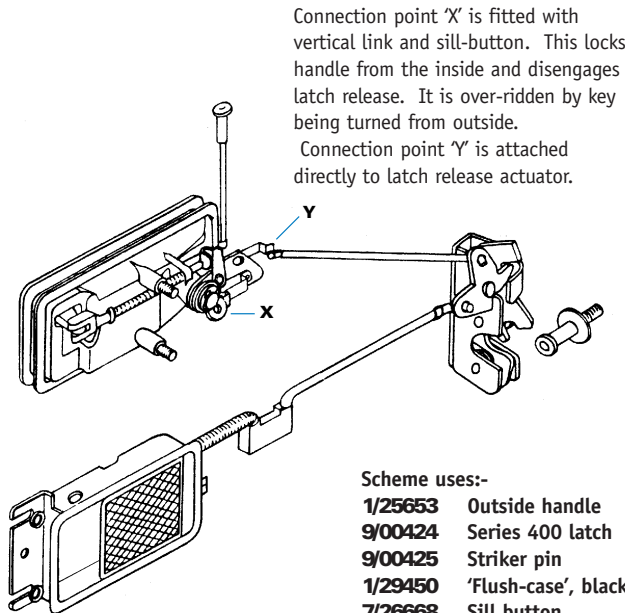

Connection point 'X' is fitted with vertical link and sill-button. This locks handle from the inside and disengages latch release. It is over-riden by key being turned from outside.
Connection point 'Y' is attached directly to latch release actuator.

- Scheme uses:-
- 1/25653 Outside handle
 - 9/00424 Series 400 latch
 - 9/00425 Striker pin
 - 1/29450 'Flush-case', black
 - 7/26668 Sill button
 - 3/14422 Inside trim bezels (not shown)

'FLAP' HANDLES - INSTALLATION SCHEMES

Our 'Flap' handles allow fully interconnected inside and outside locking/latching, and these schemes will suit on-road passenger doors.

The terms 'American' and 'European' practice signify only the favoured application methods. The schemes may be used anywhere! It is the vehicle manufacturer's responsibility to test and certify a fitted scheme.

INSTALLATION SCHEME - B - "EUROPEAN" PRACTICE

In scheme 'B', locking is done through 'blocking' features within the latch. This system is used on passenger cars, light commercials, and for auxiliary doors on recovery vehicles.

Typical door layout using 'isolated' handle with separate lock/latch functions. Right - side door.

Right-Side Door Illustrated

Inside "Flush-case" has latch release and safety flap. Both functions are connected through the latch.

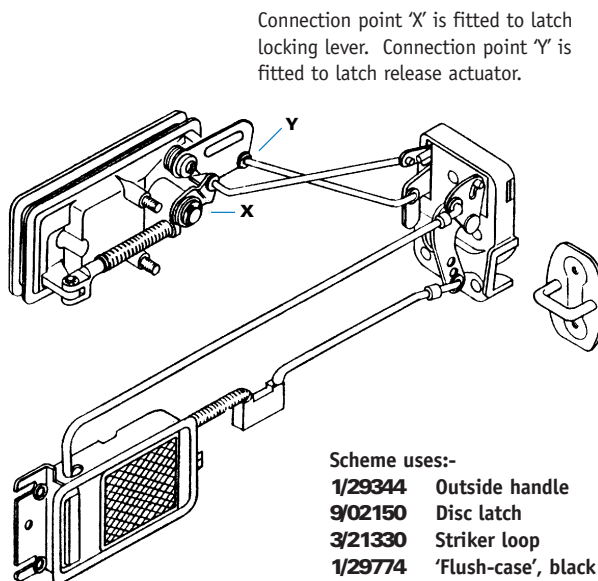

Connection point 'X' is fitted to latch locking lever. Connection point 'Y' is fitted to latch release actuator.

- Scheme uses:-
- 1/29344 Outside handle
 - 9/02150 Disc latch
 - 3/21330 Striker loop
 - 1/29774 'Flush-case', black
 - 3/14422 Inside trim bezels (not shown)

(Note: due to recent design improvement, latch does not correspond exactly to illustration.)

SILL BUTTON & FITTINGS

7/26668 sill button
Moulded in black ABS with plain core, self-taps onto thread-rolled rod (increased to 4.2 mm diameter)

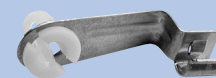

1/26869-70
Suits 5.5 mm dia.hole

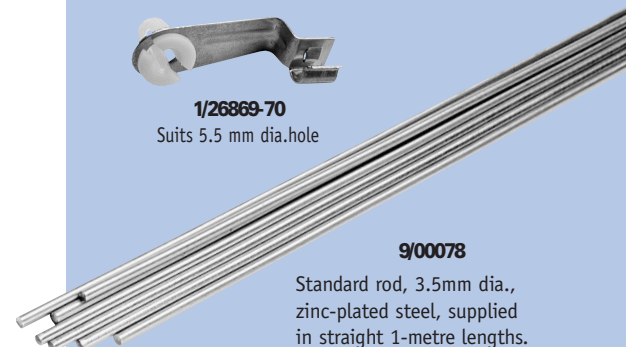

9/00078

Standard rod, 3.5mm dia., zinc-plated steel, supplied in straight 1-metre lengths.



9/00593



View of underside showing threaded bosses and operating lever

ORDERING CODE

9/00593 Semi-flush handle, 'FT' locking

9/00593/01 As above, 'FT 111' keys

SPECIFICATION

A Case length	190 mm
B Case width	120 mm
C Fixing centres	70 mm
D Fixing centres	122 mm
E Location	48 mm
F Max. height (closed)	20 mm
G Max depth (body)	35 mm
H Hole sizes	M5 x 10 mm
J Depth to actuator	63 mm
K Travel of actuator	15 mm

Note: Actuator arm can be rotated through 360°
Panel cut-out; ellipse 174 x 104 mm
Request drawing of panel-piercing if required.

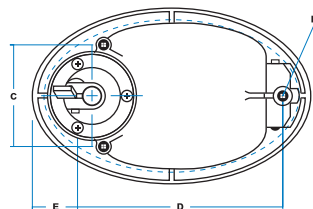
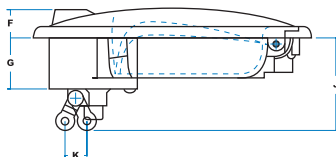
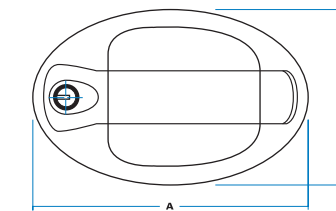

303B

SEMI-FLUSH 'PULL' HANDLE

This is an attractive, self-contained 'automotive'-style handle and recess 'dish' which is ideal for specialist vehicle applications. The handle lifts to operate an actuating lever, normally connected by wire-link to a remote latch, and the unit is easily fitted into a simple panel cut-out.

- Smart, strong, and weather-resistant, with attractive finish in self-coloured (black) composite material.
- Handle stem pulls out to 30mm (max), but both ends are always secured within base. Key turns 180° to block operation.
- Insert from front into panel cut-out, secure into three threaded bosses. A foam gasket is supplied.
- 'FT' keys only, non-locking model available.
- Black, self-coloured, with fine-textured finish.
- Moulded in Nylon-6 throughout.
- Series 400 latch or similar.

SYSTEMS

**FLUSH-FIT
LATCHES &
LOCK/LATCH
SYSTEMS**



New, 'weatherproof' paddle latch with padlockable feature



Above: Smart new 'Model 21' flush compression latch, provides 6mm of take-up

WBH offers a selection of self-contained lock/latch units, together with well-proven rod-and slam-systems, for large enclosures such as compressors and generators and truck toolboxes. Several completely new models are introduced here for the first time, including the revolutionary 'weatherproof' paddle series.

This is possibly the most complete range of flush-fit 'paddle' and 'drop-T' latches on the market, made to high standards and with a choice of options to suit the customer's exact specification



9/03440
Oval paddle with hook-latch

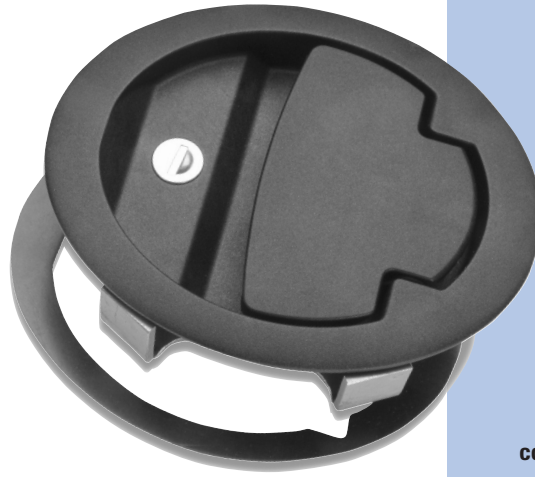

"FT" double-sided keys as standard

9/00406
Loop striker in stainless steel



ORDERING CODE

- 9/03440** Oval paddle, hook-latch, locking
- 9/03440/01** As above, standard keys FT111
- 9/00406** Loop striker (stainless steel)

SPECIFICATION

A Case length	150 mm
B Case width	120 mm
C Fixing centres	56 mm
D Fixing centres	70 mm
E Hook width (not shown)	22 mm
F Hook penetration	32 mm
G Hook engagement	12 mm
H Hole sizes	M6 x 10 mm
J Maximum depth	53 mm
K Recess length	120 mm
L Recess width	100 mm

SPECIFICATION

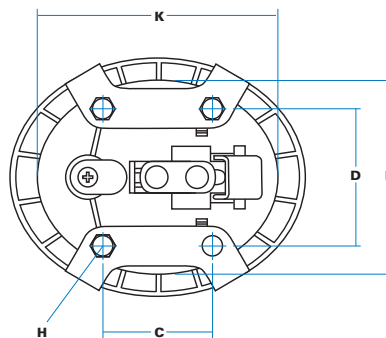
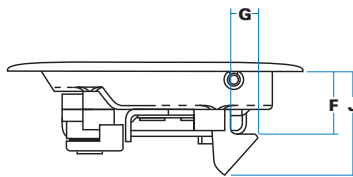
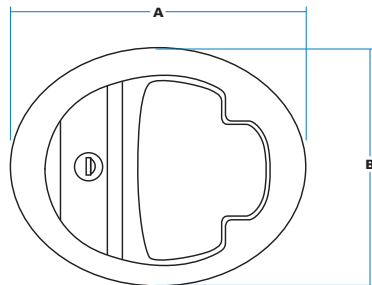

Rear view, illustrating clamping brackets and securing bolts (gasket not shown).

Note: Request drawings for panel cut-out aperture. Striker dimensions shown on page C7.



By re-shaping the 'paddle' latch concept, we have created a stylish new range that will meet the evolving needs of equipment designers for more attractive door furniture

**'OVAL' PADDLES
HOOK-LATCH
MODELS**

Our new 'Oval' paddles have superb appearance and are quick and easy to install. Made in tough, self-colour moulded materials for corrosion resistance, they are flush-fitting and have no visible mounting points.

The 'hook-latch' design incorporates a spring-loaded stainless steel 'hook' that projects vertically from the back of the paddle case rather than the conventional slam-bolt. This gives a much smoother action – doors close easily, and do not 'bounce back'. The loop striker (also in stainless steel) ensures positive engagement which resists vibration.

- As door closes the ramped face of the hook meets striker and is forced laterally. Once closed, the spring action secures hook under striker loop.
- 'Deadbolt' action, so that when key cylinder is locked, both flap and hook are held rigid. Paddles will not slam in locked condition.
- Unit fits through aperture, is clamped against panel by two shaped brackets, and secured by bolts into four threaded bosses. Gasket provided.
- Double-sided 'FT' keys with shuttered keyway, or optionally 'FS' keys.
- Black, self-coloured, with lightly-textured finish.
- Case & flap in glass-filled nylon, mild steel components are zinc plated for corrosion resistance.
- Alternative, deeper hook (F= 44mm). Special key numbers and sets.

Registered European Design number 000187513-0001



9/03419

Oval paddle with slam-bolt



"FT" double-sided keys as standard

ORDERING CODE

9/03419 Oval paddle, slam-bolt, locking

9/03419/01 As above, standard keys FT111

SPECIFICATION

A Case length	150 mm
B Case width	120 mm
C Fixing centres	56 mm
D Fixing centres	70 mm
E Bolt width	19 mm
F Bolt penetration	21 mm
G Bolt projection (max)	26 mm
H Hole sizes	M6 x 10 mm
J Maximum depth	40 mm
K Recess length	120 mm
L Recess width	100 mm

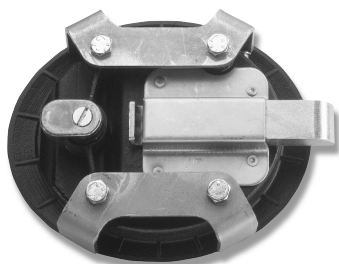

Rear view, illustrating clamping brackets and securing bolts (gasket not shown).

SPECIFICATION

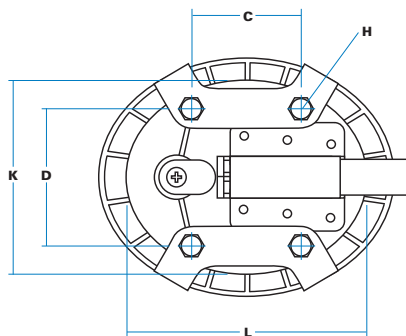
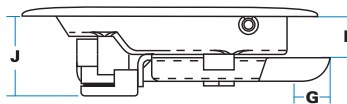
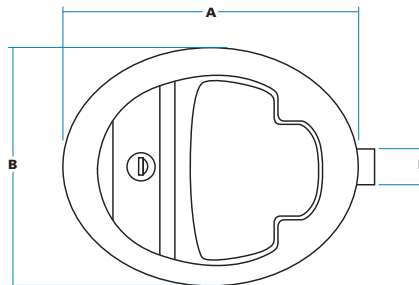

Note: Request drawings for panel cut-out aperture. Diecast strikers shown on page D32.

NEW

By re-shaping the 'paddle' latch concept, we have created a stylish new range that will meet the evolving needs of equipment designers for more attractive door furniture

'OVAL' PADDLES SLAM-BOLT MODELS

Our new 'Oval' paddles have superb appearance and are quick and easy to install. Made in tough, self-colour moulded materials for corrosion resistance, they are flush-fitting and have no visible mounting points.

These are slam-action models using a machine-cut solid bolt in mild steel. They are used in applications where the door aperture must be completely unobstructed, and the bolt engages against the doorframe, or with a suitable striker.

Slam-action against door edge, released by lifting flap.

Locking with key blocks movement of flap, but bolt is free to operate and will slam shut. It can still be opened from inside (when interior-release knob is fitted).

Unit fits through aperture, is clamped against panel by two shaped brackets, and secured by bolts into four threaded bosses. Gasket provided.

Double-sided 'FT' keys with shuttered keyway, or optionally 'FS' keys.

Black, self-coloured, with lightly-textured finish.

Case & flap in glass-filled nylon, bolt case & slide in stainless steel, mild steel slam bolt is zinc plated for corrosion resistance.

- Alternative slam bolts.

- Inside-release knob

- Special key numbers and sets.



9/05462



Double-sided 'FT' keys
as standard



ORDERING CODE

9/05462	Weatherproof paddle, locking
9/05462/01	As above, standard keys FT111
9/00406	Loop striker (stainless steel)



Side-view showing standard- & extended-hook penetration.

Weight 240g - compared to steel equivalent at 470g

Panel-piercing

Request drawings for panel cut-out aperture.

SPECIFICATION

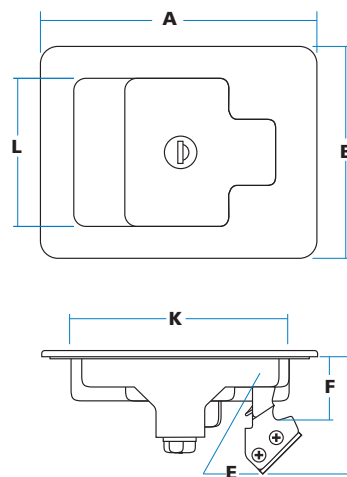

A Case length	140 mm
B Case width	108 mm
E Max travel	30 mm
F Hook penetration	(standard) 32 mm (special) 50 mm
J Maximum depth	59 mm
K Recess length	111 mm
L Recess width	81 mm

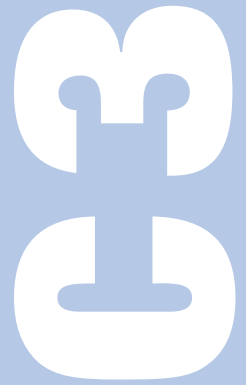

WBH has completely re-designed the traditional rectangular 'paddle' to eliminate apertures in the rear shell that could allow entry of water, using composite materials to prevent corrosion and scratching.

WEATHERPROOF 'PADDLES' HOOK- LATCH ACTION

These new paddles are weatherproof, lightweight, and acoustically 'quiet'. Flush-fitting, and with no visible mounting points, they can be quickly installed in the same aperture as our standard rectangular 'paddles' using 'U' bracket and bolts provided. A loop-striker (in stainless steel) ensures positive engagement to resist vibration.



Moulded case with integral gasket and no rear apertures prevents entry of water. Moulded 'ramp' on hook provides exceptionally smooth action.



As door closes the ramped face of hook meets the striker and is forced to engage. Once shut, spring action secures hook under striker loop.



Locking with key blocks movement of flap but hook is still free to operate and will slam shut.



Fixed with two M8 stainless bolts and steel 'U'-bracket which clamps paddle against underside of panel.



Double-sided 'FT' keys with shuttered keyway, or optionally 'FS' keys.



Black, self-coloured, with lightly-textured finish.



Case & flap moulded in glass-filled nylon, steel components are zinc-plated for corrosion resistance.



A special extended 'hook' is available (dimension 'F' = 50mm) which offers greater depth of penetration (see illustration).

UK patent NO: 0606631-0
US patent NO: 11/693,428



9/05462/PL

WBH has completely re-designed the traditional rectangular 'paddle', eliminating apertures in the rear shell that might allow entry of water and using composite materials to prevent corrosion and scratching.

WEATHERPROOF 'PADDLES' PADLOCKABLE MODELS

This is a development on our 'weatherproof' concept, replacing the lock cylinder with a diecast, spring-loaded 'pillar' or knob, that allows a padlock to be fitted, providing visible evidence that the enclosure is securely locked. A loop-striker (in stainless steel) ensures positive engagement.

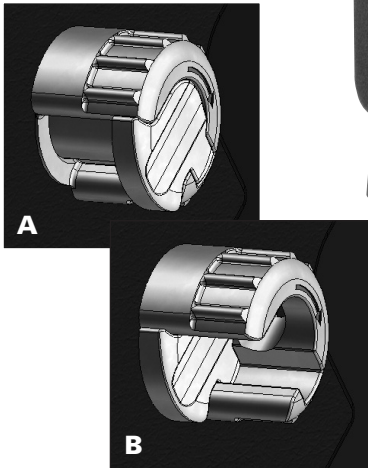

View A shows knob in 'rest' position.
View B shows the top section retracted to allow entry of padlock shackle

UK patent No: 0606631-0
US patent No: 11/693, 428

ORDERING CODE

9/05462/PL Padlockable Paddle
9/00406 Loop Striker (Stainless Steel)

SPECIFICATION

9/00406 Striker (stainless)

M	Total projection	48 mm
N	Hole centres	20 mm
O	Hole sizes	(dia) 7 mm
P	Total width	55 mm
R	Total depth	31 mm

Striker made in 6mm diameter stainless rod, welded to stainless backplate. Alternatively it can be supplied without bend (M=80mm) as 9/00406/02.

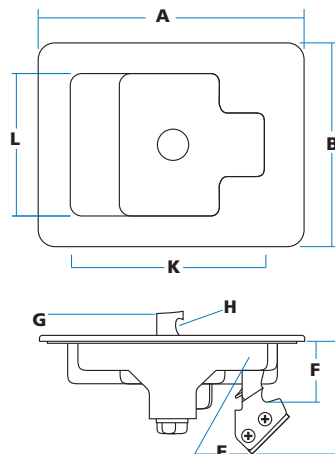

A	Case length	140 mm
B	Case width	108 mm
E	Max travel	30 mm
F	Hook penetration	(standard) 32 mm (special) 50mm
G	height of knob	15 mm
H	Hole for padlock	(dia) 6.5 mm
J	Maximum depth	59 mm
K	Recess length	111 mm
L	Recess width	81 mm

! Moulded case with integral gasket and no rear apertures prevents entry of water. Moulded 'ramp' on hook provides exceptionally smooth, quiet action. Fits same aperture as our standard rectangular 'paddles'.

W Close door so that ramped face of hook meets striker and is forced to engage. Once shut, turn diecast knob through 90° to secure flap against base, then depress top and insert padlock through aperture. The flap now cannot open.

↕ Locking with padlock (as above) prevents movement of flap but hook is still free to operate and will slam-shut.

U Fixed with two M8 stainless bolts and steel 'U'-bracket which clamps paddle against underside of panel.

W Black, self-coloured, with lightly-textured finish, chrome-plated knob.

M Case & flap moulded in glass-filled nylon, steel components are zinc-plated for corrosion resistance.

? A special extended 'hook' is available (dimension 'F' = 50mm) which offers greater depth of penetration.

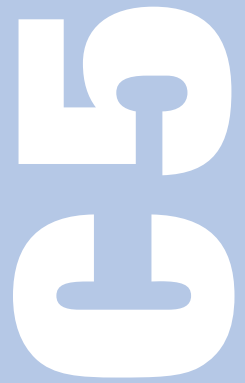

**9/00450
with Slam-Bolt**



**Single-sided 'FS' keys
as standard**

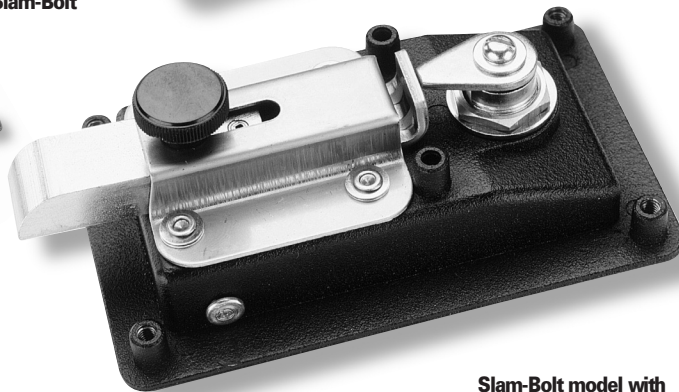

**Slam-Bolt model with
interior release knob**

ORDERING CODE

9/00450	Diecast paddle, black, slam-bolt
9/00450/01	As above, FS 880
9/00453	Diecast paddle, black, remote operation
9/00453/01	As above, FS 880
9/00457	Diecast paddle, black, 2-way
9/00457/01	As above, FS 880

SPECIFICATION

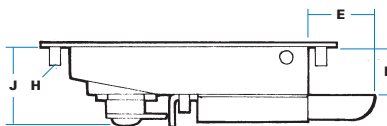
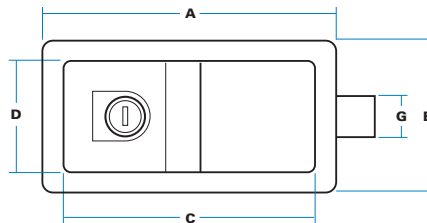

Remote operation model (Illustration)

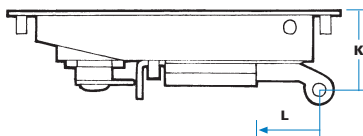

K Depth to link point	36 mm
L Travel (horizontal)	10 mm

2-way operation model

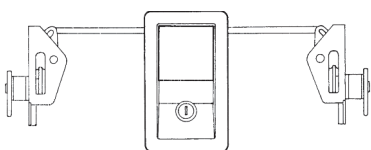

Scheme shows 'paddle' vertical, with two 'claw' latches. Alternatively two slam latches can be fitted, using standard linkage bar (3/12497) at length 915 mm (cut to size). Movement is 13 mm approx., at each side.







A Case length	136 mm
B Case width	82 mm
C Hole centres	120 mm
D Hole centres	66 mm
E Bolt projection	28 mm
F Bolt depth	20 mm
G Bolt width	19 mm
H Holes tapped	10-32 UNF x 8 mm
J Maximum depth	35 mm
Slam bolt withdraws by 10 mm, max.	

The 'Paddle' concept provides an attractive, fully self-contained lock/latch, which is flush fitting and simple to install

SMALLER-SIZE DIECAST 'PADDLE' HANDLE SERIES

The smallest models in our 'paddle' range, with smooth, blended lines made possible by diecast construction.

Textured finish and invisible fixing make this design most suitable when good visual appearance is paramount.

-  Blended lines, concealed fixing, textured finish and "no rattle" operation, with solid, machined steel slam bolt.
-  Basic model has slam-bolt fitment, but handle variants provide remote-operation or 2-way function.
-  Locking with key blocks movement of flap but slam bolt is still free to operate and can be opened from inside if release knob is fitted. Non-handed.
-  Concealed-fixing from beneath into four tapped bosses on handle rim.
-  'FS' keys as standard with shuttered keyway. Optionally 'FT' '92' or 'DLP' key types.
-  Black powder coated with textured finish. Stainless bolt case and slide.
-  - Inside release knob on slam-bolt models
- Alternative slam bolts (length, profile)

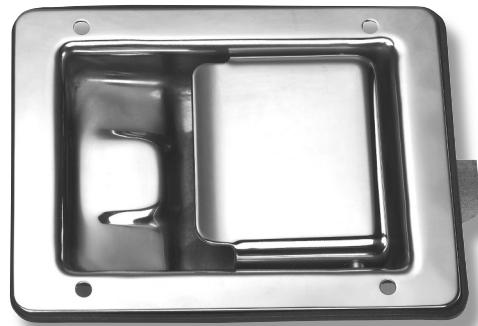

9/00408
(non-locking)
stainless steel

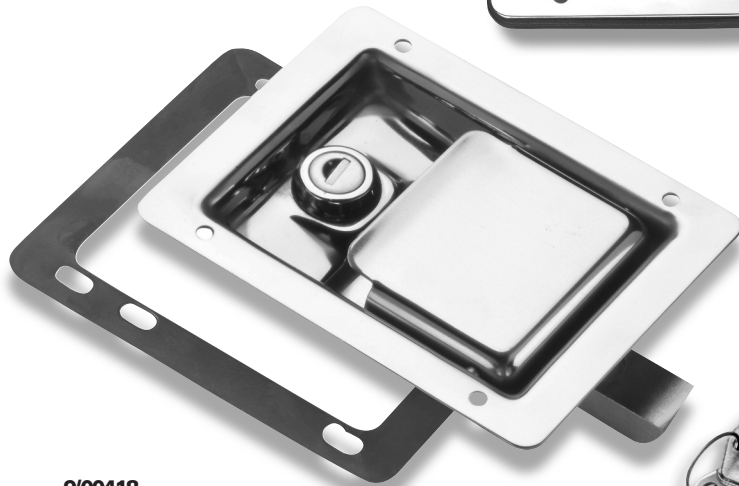

9/00418
(locking)
stainless steel



Single-sided
'FS' keys
are standard

The 'Paddle' concept provides an attractive, fully self-contained lock/latch, which is flush fitting and simple to install

STEEL 'PADDLES' SLAM-BOLT MODELS

These are slam-action paddles using a machine-cut solid bolt. Stainless models have pierced rim, mild steel models are normally supplied with plain, unpierced rim for weld-on installation

ORDERING CODE

Mild steel models, with plain rim & gasket

9/00419	Slam-bolt paddle, locking
9/00419B	As above, black
9/00419/01	As 9/00419, FS880 standard keys
9/00419B/01	As above, black
9/00420	Slam-bolt paddle, non-locking
9/00420B	As above, black

Stainless models with pierced rim & gasket

9/00418	Slam-bolt paddle, locking
9/00418/01	As 9/00418, FS880 standard keys
9/00408	Slam-bolt paddle, non-locking

SPECIFICATION

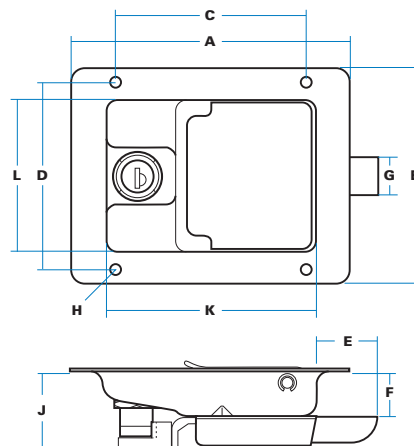

A Case length	140 mm
B Case width	108 mm
C Hole centres	95 mm
D Hole centres	94 mm
E Bolt projection (max)	28 mm
F Bolt depth	22 mm
G Bolt width	19 mm
H Hole sizes (diameter)	5 mm
J Maximum depth	40 mm
K Recess length	105 mm
L Recess width	76 mm

! Precision, machine-cut solid steel slam-bolt, heavy duty slide and locking cam, mirror finish on case/flap and no sharp edges. Moulded gasket supplied.

W Slam action against door frame or striker, released by lifting flap.

U Locking with key blocks movement of flap, but slam bolt is still free to operate and can be opened from inside ("Deadlocking" is a special option).

M Stainless models have pierced rim as shown or internal welded studs, with moulded gasket. Mild steel models normally have plain rim (for weld-on mounting).

K 'FS' keys as standard with shuttered keyway. Optionally 'FT', '92' or 'DLP', key types. Non-locking models as shown.

P Polished stainless steel or mild steel, clear zinc-plated. Optionally, black powder-coated finish.

M With stainless models, all components made in Grade 304 other than slam-bolt (stainless to special order). With mild steel models, case & flap made in CR4.

? See opposite page for options available

Panel-piercing

See page C12 for details of panel cut-out required

9/00460B
(locking)



Blind-mount models :

ORDERING CODE

Mild steel models, blind mounting (& gasket)

- 9/00460 Slam-bolt paddle, locking
- 9/00460B As above, black
- 9/00460/01 As 9/00419, FS880 standard keys
- 9/00460B/01 As above, black

- 9/00461 Slam-bolt paddle, non-locking
- 9/00461B As above, black

Stainless models, blind mounting (& gasket)

- 9/00470 Slam-bolt paddle, locking
- 9/00470/01 As 9/00418, FS880 standard keys
- 9/00471 Slam-bolt paddle, non-locking

Padlockable paddles

The loop has 10mm aperture and is made in double-section stainless steel for strength and scratch resistance. It can be added to almost any of our standard 'paddle' models.

To order, add the suffix "/PL" to our regular part numbers.

SPECIFICATION

Blind-mounting models have four studs (M6x15mm) welded on inside rim. Consult engineering drawing for position of studs (not same as holes).

Recommended maximum torque for securing weld-studs is 4.5Nm (3.3ft. lb)

Panel-piercing

See page C12 for details of panel cut-out required

Inside release option

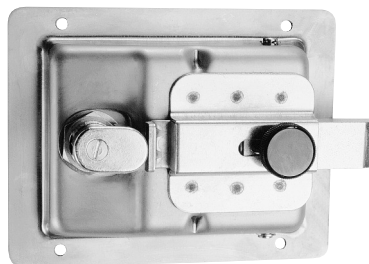

A knob for inside release can be fitted to all slam-bolt models. This operates even when paddle has been locked from outside
Add suffix "/IR" to part number





The 'Paddle' concept provides an attractive, fully self-contained lock/latch, which is flush fitting and simple to install

STEEL 'PADDLES' SLAM-BOLT OPTIONS

Many design options are available with 'paddle' latches. This page shows some of the special features available for slam-bolt models.

 Blind-mounting, with four studs (M6 x 15mm) welded on inside rim. Consult engineering drawing for position of studs (not same as pierced holes).

 Alternative key types ('FT' double-sided keys), '92' series, etc. - Tool-operated plug (triangular, square-drive, etc) - Padlockable loop in flap as shown.

 Black powder-coated, or other colours as specified.

 'Deadbolt' locking; with this option the flap & bolt are held rigid when key cylinder is locked, and the latch will not slam. This feature eliminates any possibility of a door being secured by accident.

 Alternative slam bolts (length, nose-form) - Weathershield fitted to lock cylinder - Inside release knob as shown.

2-way paddle system



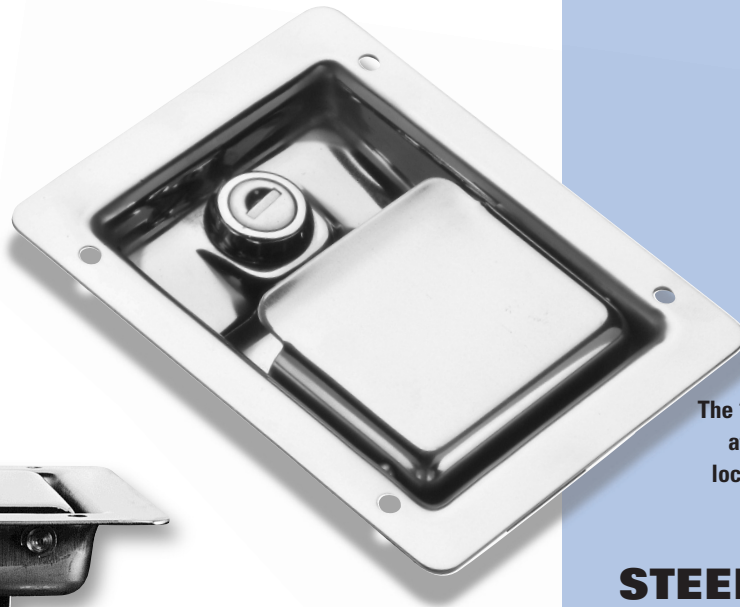

9/00448 (locking)



Single-sided
'FS' keys
are standard



9/00406
Striker
(stainless)

The 'Paddle' concept provides an attractive, fully self-contained lock/latch, which is flush fitting and simple to install

STEEL 'PADDLES' HOOK-LATCH MODELS

This unique design replaces the conventional slam-bolt with a spring-loaded stainless steel 'hook' that projects vertically from the back of the paddle case. This gives a much smoother action - doors close easily with gentle push, and do not 'bounce back'. A striker (in stainless steel) ensures positive engagement which resists vibration.



As door closes, the ramped face of the hook meets striker and is forced laterally (E). Once closed the spring action secures hook under striker loop.



This model normally has 'deadbolt' action. When key cylinder is locked, both flap and hook are held rigid. Paddles therefore will not slam in locked condition



Stainless models have pierced rim as shown, with moulded gasket. Mild steel models normally have plain rim (for welded-on mounting).



'FS' keys as standard with shuttered keyway. Optionally 'FT', '92' or 'DLP', key types. Non-locking models available.



Polished stainless steel or mild steel, clear zinc-plated. Optionally, black powder-coated finish.



With stainless models, case & flap in Grade 304, all other components made in CR4, zinc plated. 'Hook' is in stainless steel as standard.



See opposite page for options available

ORDERING CODE

Mild steel models, with plain rim & gasket

9/00440	Hook-latch paddle, locking
9/00440B	As above, black
9/00440/01	As 9/00440, FS880 standard keys
9/00440B/01	As above, black
9/00441	Hook-latch paddle, non-locking
9/00441B	As above, black

Stainless models with pierced rim (& gasket)

9/00448	Hook-latch paddle, locking
9/00448/01	As 9/00448, FS880 standard keys
9/00449	Hook-latch paddle, non-locking
9/00406	Loop striker (stainless steel)

SPECIFICATION

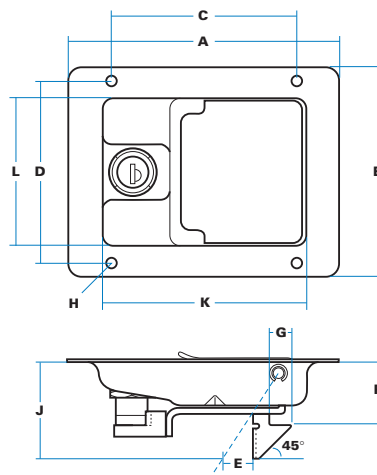

A	Case length	140 mm
B	Case width	108 mm
C	Hole centres	95 mm
D	Hole centres	94 mm
E	Max travel	16 mm
F	Hook penetration	32 mm
G	Hook engagement	12 mm
H	Hole sizes (dia)	5 mm
J	Maximum depth	56 mm
K	Recess length	105 mm
L	Recess width	76 mm

Panel-piercing

See page C12 for details of panel cut-out required

model with
special 50mm
'Extended Hook'



model with standard
32mm hook

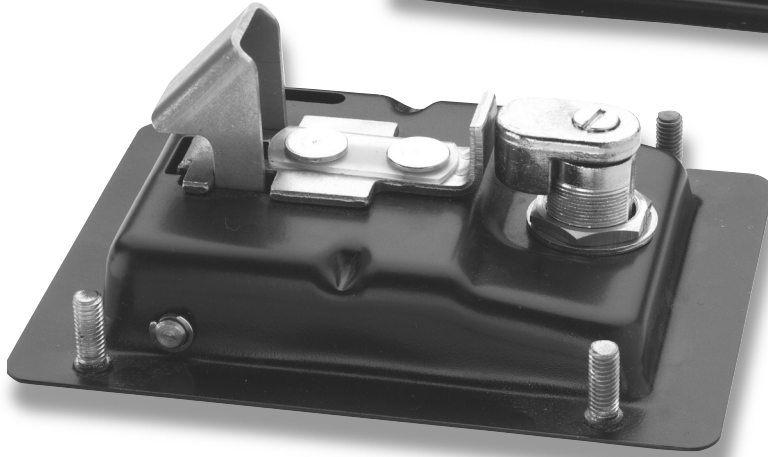

Standard 'blind-mounted' models shown below :

ORDERING CODE

Mild steel models, blind-mounting (& gasket)

- 9/00462** Hook-latch paddle, locking
- 9/00462B** As above, black
- 9/00462/01** As 9/00462, FS880 standard keys

9/00462B/01 As above, black

- 9/00463** Hook-latch paddle, non-locking
- 9/00463B** As above, black

Stainless models, blind-mounting (& gasket)

- 9/00472** Hook-latch paddle, locking
- 9/00472/01** As 9/00472, FS880 standard keys
- 9/00473** Hook-latch paddle, non-locking

9/00406 Loop striker (stainless steel)

Blind-mounting models have four studs (M6x15mm) welded on inside rim. Consult engineering drawing for position of studs (not same as holes).

Recommended maximum torque for securing weld-studs is 4.5Nm (3.3ft. lb)

Panel-piercing

See page C12 for details of panel cut-out required

Extended Hook

A special, extended "hook" is now available, (dimension F = 50mm). This offers greater depth of penetration, making these latches a useful equivalent to 'Pommier' models.

Add suffix "/EH" to regular ordering codes.

9/00406 Striker (stainless)

M Total projection	48 mm
N Hole centres	20 mm
O Hole sizes	(dia) 7 mm
P Total width	55 mm
R Total depth	31 mm

Striker made in 6mm diameter stainless rod, welded to stainless backplate. Alternatively it can be supplied without bend (M=80mm) as 9/00406/02.



The 'Paddle' concept provides an attractive, fully self-contained lock/latch, which is flush fitting and simple to install

STEEL 'PADDLES' HOOK-LATCH OPTIONS

Many design options are available with 'paddle' latches. This page shows some of the special features available for hook-latch models.

- Blind-mounting, with four studs (M6 x 15mm) welded on inside rim. Consult engineering drawing for position of studs (not same as pierced holes).
- Alternative key types ('FT' double-sided keys), '92' series, etc. - Tool-operated plug (triangular, square-drive, etc) - Padlockable loop in flap.
- Black powder-coated, or other colours as specified.
- 'Non-'Deadbolt' locking; with this option the paddle will slam even when key cylinder is locked. This is not the normal mode of operation.
- Special 'Extended Hook', so that 'F' dimension = 50mm, for greater penetration below surface. Weathershield fitted to lock cylinder

Rotary action
paddles





9/00492
Rotary latch



9/00426
Striker plate

ORDERING CODE

Stainless models, pierced rim (& gasket)

9/00492 Rotary-latch paddle, locking

9/00493 Rotary-latch paddle, non-locking

Mild Steel models, plain rim (& gasket)

9/00490 Rotary-latch paddle, locking

9/00491 Rotary-latch paddle, non-locking

9/00426 Striker plate

Consult sales office for 'blind-mount' models

SPECIFICATION

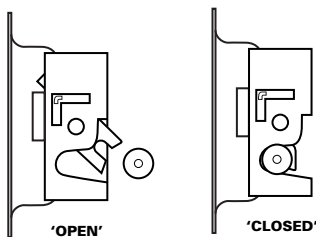
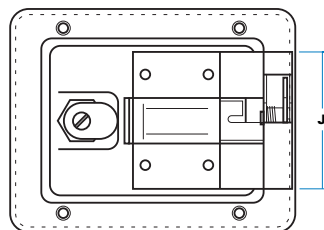
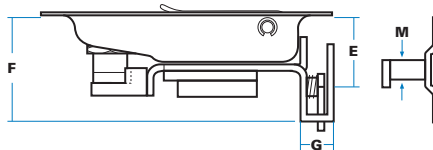
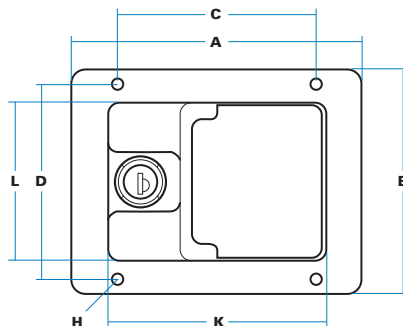

Rear-view shows paddle with built-in latch and hardened steel "claw" in open position.

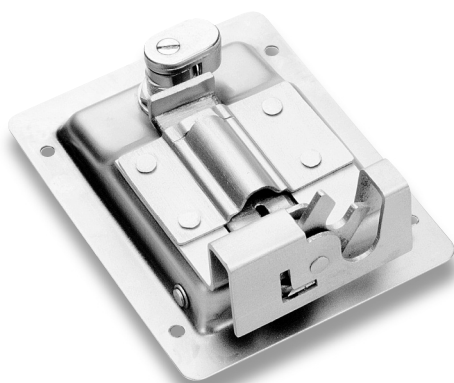









E Depth to pin centre	30 mm
F Max. Depth	48 mm
G Width of latch body	16 mm
J Length of latch body	70 mm
M Striker pin diameter	10 mm
N Striker hole centres	40 mm

All other dimensions as for standard paddle case

STEEL 'PADDLES' WITH 2-STEP ROTARY LATCH

The 'Paddle' concept provides an attractive, fully self-contained lock/latch, which is flush fitting and simple to install

The advantage of this new design is that the built-in rotary latch provides very positive slam-action and anti-burst protection, which prevents accidental opening through vibration or impact. Ideal for large mobile items of plant and equipment but not suitable for vehicle personnel doors.

-  Exceptionally smooth action, strong return spring on flap to prevent rattle, hardened steel 'claw' and heavy-duty locking cam on key cylinder.
-  'Claw' slams against striker pin, and is released when paddle flap is lifted.
-  2-stage closing action of 'claw', which is completely blocked when key is turned to locked position. Cannot be locked when claw is in 'open' position. Non-handed, can be reversed.
-  Stainless models have pierced rim as shown, or internal welded studs. Mild steel models have plain rim (for weld-on) or studs. Gasket supplied.
-  'FS' as standard, optionally 'FT', '92', or 'DLP' key types. Non-locking models are available.
-  Polished stainless steel, or mild steel, bright zinc-plated. Optionally, black powder-coated finish.
-  With stainless models, case and flap made in Grade 304. All other components mild steel, with diecast cylinder and locking cam.
-  Highly competitive against market alternatives.

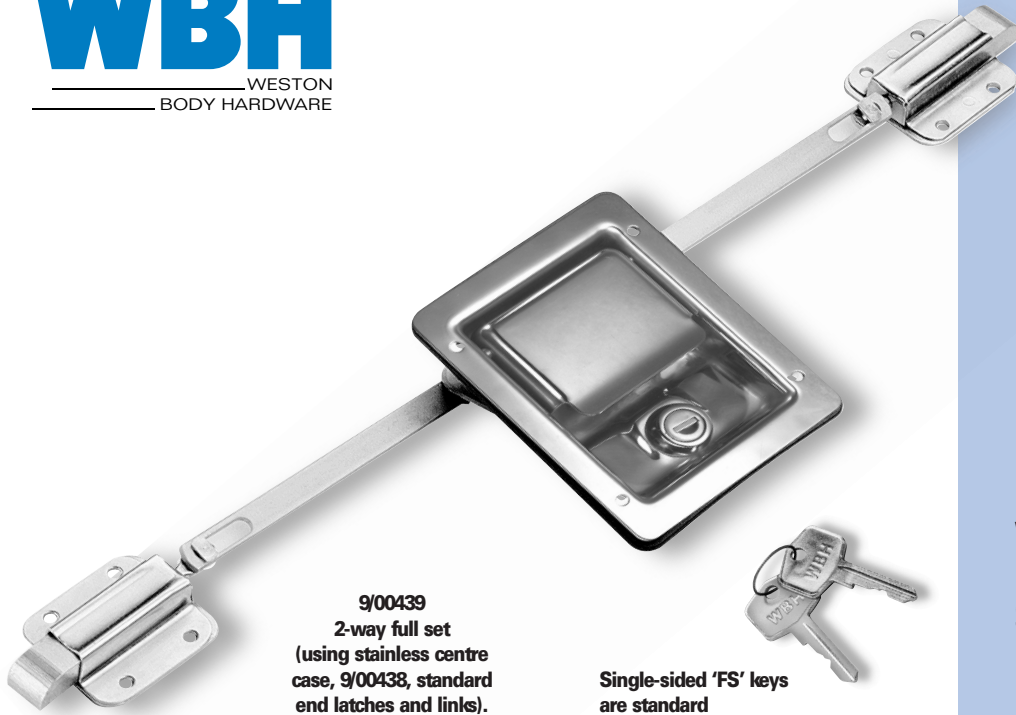

9/00439
2-way full set
(using stainless centre
case, 9/00438, standard
end latches and links).

Single-sided 'FS' keys
are standard

The 'Paddle' concept provides an attractive, fully self-contained lock/latch, which is flush fitting and simple to install

STEEL 'PADDLES' 2-WAY MODELS

With these units the paddle case has an integral 2-way mechanism, allowing it to be used for slam systems on larger doors, fitted vertically or horizontally. Full choice of finish options, with several types of end latches. Order as centre units only, or full sets as illustrated.

! All-stainless mechanism, heavy duty slide and locking cam, mirror finish on case/flap and no sharp edges. Moulded gasket supplied.

W Latches slam against sides of door frame or strikers, released by lifting paddle flap.

↕ Locking with key blocks flap and 2-way mechanism, but end latches are still free to operate using 'free movement' aperture in link bar (as illustrated).

M Stainless models have pierced rim as shown or internal welded studs, with moulded gasket. Mild steel models normally have plain rim (for weld-on mounting). Link bars held by split pin on pillar rivets.

Key 'FS' as standard, optionally 'FT', '92', or 'DLP' key types. Non-locking models.

Wrench Polished stainless steel, or mild steel, bright zinc-plated. Optionally, black powder-coated finish.

M With stainless models, all steel components made in Grade 304. With mild steel models, case and flap made in CR4, zinc-plated, with diecast cylinder and locking cam.

? - Moulded weathershield on (round) lock
- Alternative end latches
- Centre case with shaped 'grip'

ORDERING CODE

Stainless models with pierced rim (& gasket)

9/00438	2-way paddle centre, locking
9/00438/01	2-way paddle centre, FS 880
9/00439	2-way paddle system, locking
9/00439/01	2-way paddle system, FS 880
9/00417	2-way paddle centre, non-locking
9/00437	2-way paddle system, non-locking

Mild Steel models with plain rim, (& gasket)

9/00409	2-way paddle centre, locking
9/00409/01	2-way paddle centre, FS 880
9/00429	2-way paddle system, locking
9/00429/01	2-way paddle system, FS 880
9/00416	2-way paddle centre, non-locking
9/00436	2-way paddle system, non-locking

Consult sales office for 'blind-mount' models

'Blind-mounting' models

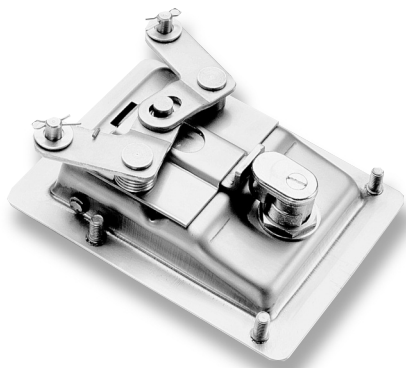

'Blind mounting' models have four studs (M6x15mm) welded on inside flanges. This option is available on all paddles. Consult engineering drawing for position of studs (not same as holes).

SPECIFICATION

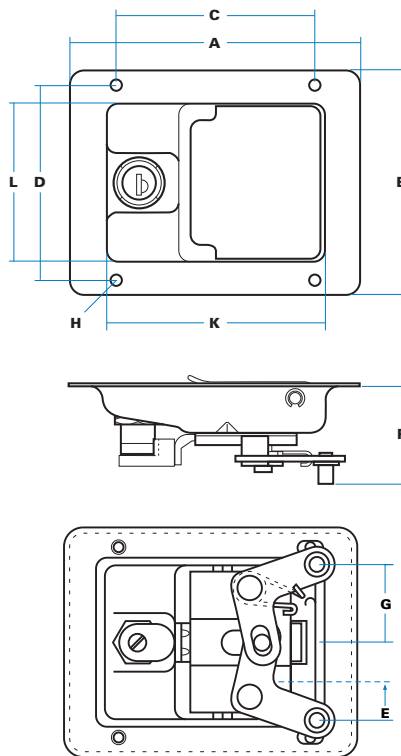

E	'Travel' of link point	15 mm
F	Depth of link point	37 mm
G	Location of link point	47 mm

Note : 'F' can be reduced to 30mm by mounting pillars on inside face of levers.

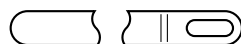

Standard linkage bar 3/12497 (915 mm) used for 2-way slam system. Piercing allows 'quick fit' attachment of latches and free movement when centre is locked.

STEEL PADDLES STANDARD PANEL-PIERCING DIMENSIONS

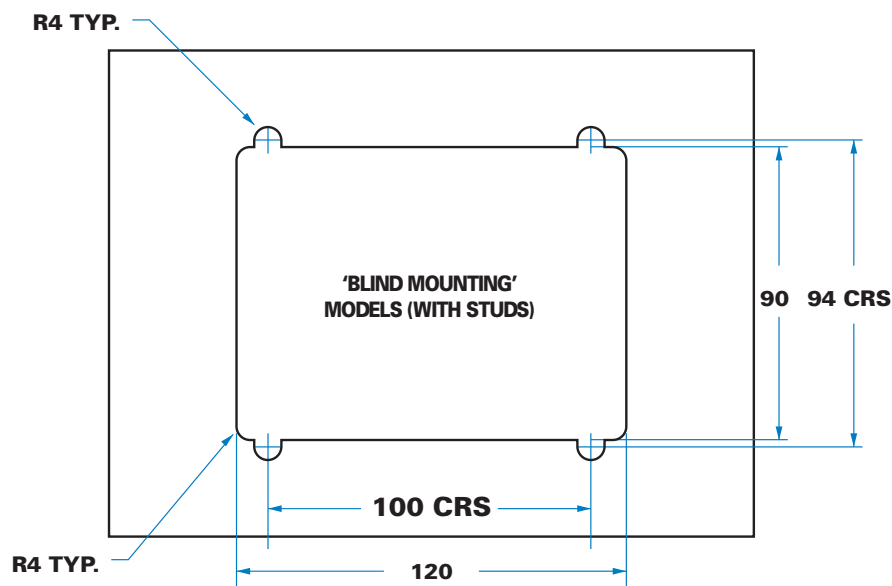
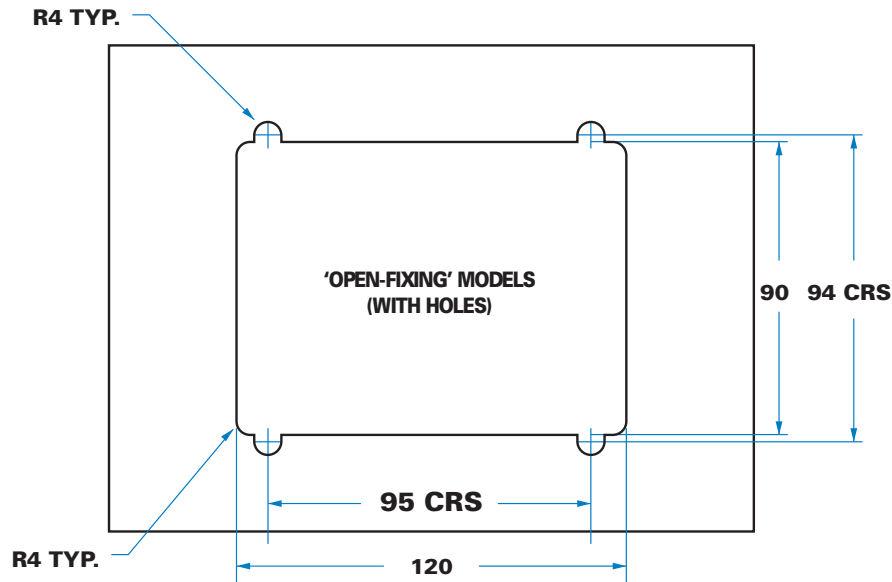

These are recommended panel-piercing dimensions for our range of standard-size steel paddle latches, both locking and non-locking models. Note the different fixing-centres for open-fix and concealed-fix ('blind-mounted') models.

Open-fixing models can be mounted with rivets, or M6 (1/4-inch) dome-headed bolts and appropriate washers and securing nuts.

Concealed-fix models have 4-off weld-studs, (M6 x 15mm) at positions shown. Recommended maximum torque when applying nuts is 4.5Nm (3.3 ft.lb).

Note: Some stainless models have different fixing-centres, as specified by individual customers

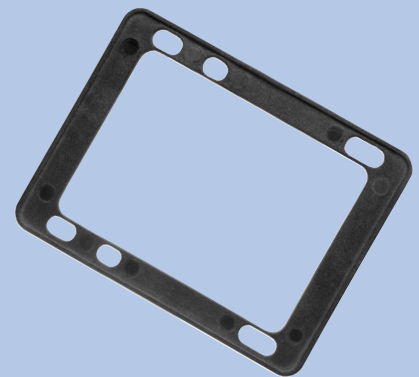

MP00502
Gaskets are provided with all standard 'paddle' models.

9/02028
(in stainless steel)



Double-sided "FT" keys as standard

'DEEP-DISH' PADDLES, SLAM-BOLT MODELS

By providing a deeper, longer case and relocating the lock cylinder, these 'paddles' allow easy and unimpeded access by a gloved hand. They are highly suited to larger doors and heavy items of plant. Mild steel or stainless models, non-handed.

! Deep dish (30 mm) with internal finger-shield and beaded edge on flap for easy operation. Stainless locking bolt slides on carrier, giving protection against flap being forced. Low-profile lock with double-sided key cylinder as standard.

W Slam action against door frame or striker, released by lifting flap.

U Locking with key blocks movement of flap, but slam bolt can still be slammed and opened from inside.

M Pierced rim, internal welded studs, or plain rim with mild steel models (for weld-on fixing). Gasket supplied.

K 'FT' keys as standard, with shuttered keyway. Optionally, 'FS', '92', 'DLP' or 'Ronis' key types. Non-locking models.

P Polished stainless steel, or mild steel, clear zinc-plated. Optionally, black powder-coated finish.

M With stainless models, all components made in Grade 304. With mild steel models, case and flap in CR4 with mild steel slam bolt.

? Alternative slam bolts (length, profile). Inside release knob.

T Tested to destruction, paddle flap withstood a direct load of 42Nm (2.45kN). Equivalent to a 'pull' of 245Kg (540lbs). Endurance (cycle) testing: The latch was slammed/opened for over 50,000 cycles with no discernable wear.

ORDERING CODE

Stainless models with pierced rim

9/02028	Deep-dish paddle, locking
9/02028/01	As above, FT111
9/02029	Deep-dish paddle, non-locking

Mild steel models with plain rim

9/02006	Deep-dish paddle, locking
9/02006/01	As above, FT111
9/02007	Deep-dish paddle, non-locking

Mild steel models with pierced rim

9/02008	Deep-dish paddle, locking
9/02008/01	As above, FT111
9/02009	Deep-dish paddle, non-locking

Panel-piercing

See page C18 for details of panel cut-out required.

Stud-fixed models

Blind-mounting models have four studs (M6x10mm) welded on inside rim. Consult engineering drawing for position of studs. see page C19

Reverse-flap paddle

Our revolutionary 'reverse-flap' design allows the paddle to be mounted at bottom of a top-hinged door. see page C15

SPECIFICATION

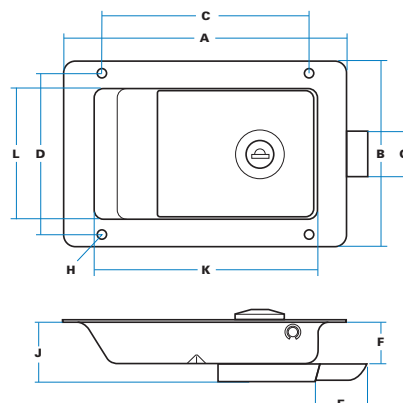

A Case length	170 mm
B Case width	110 mm
C Hole centres	100 mm
D Hole centres	99 mm
E Bolt projection (max)	28 mm
F Bolt depth	30 mm
G Bolt width	19 mm
H Hole sizes (dia)	7 mm
J Maximum depth	44 mm
K Recess length	142 mm
L Recess width	82 mm



9/02022
(in stainless steel)



Double-sided "FT" keys as standard

9/00406
Striker
(stainless)



'DEEP-DISH' PADDLES, HOOK-LATCH MODELS

With this design a spring-loaded steel 'hook' projects vertically from the back of the paddle case, which engages with a rod or loop striker. This gives a smooth action and doors close easily without 'bounce back'. These models are widely used on construction plant for toolboxes and engine covers.

! Deep dish (30 mm) with internal finger-shield and beaded edge on flap for easy operation. Stainless locking bolt slides on carrier, giving protection against flap being forced. Extra-wide 'hook' (30 mm) for good engagement and seating.

W As door closes, the ramped face of the hook meets striker and is forced laterally through 30°. Once closed the spring action secures hook under striker.

↕ Locking with key blocks movement of flap, but latch can still be slammed.

M Pierced rim, internal welded studs, or plain rim with mild steel models (for weld-on fixing). Gasket supplied.

🔑 'FT' keys as standard, with shuttered keyway. Optionally, 'FS', '92', 'DLP' or 'Ronis' key types. Non-locking models.

🔧 Polished stainless steel, or mild steel, clear zinc-plated. Optionally, black powder-coated finish.

M With stainless models, all components made in Grade 304. With mild steel models, case and flap in CR4.

T Tested to destruction, paddle flap withstood a direct load of 42Nm (2.45KN). Equivalent to a 'pull' of 245Kg (540lbs).

Endurance (cycle) testing: The latch was slammed/opened for over 50,000 cycles with no discernable wear.

ORDERING CODE

Stainless models with pierced rim

9/02022	Deep-dish paddle, locking
9/02022/01	As above, FT111
9/02023	Deep-dish paddle, non-locking

Mild steel models with plain rim

9/02000	Deep-dish paddle, locking
9/02000/01	As above, FT111
9/02001	Deep-dish paddle, non-locking

Mild steel models with pierced rim

9/02002	Deep-dish paddle, locking
9/02002/01	As above, FT111
9/02003	Deep-dish paddle, non-locking

9/00406 Loop striker (stainless steel)

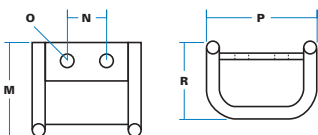

M Total projection	48 mm
N Hole centres	20 mm
O Hole sizes	(dia) 7 mm
P Total width	55 mm
R Total depth	31 mm

Striker made in 6mm diameter stainless rod, welded to stainless backplate. Alternatively it can be supplied without bend (M=80mm) as 9/00406/02.

SPECIFICATION

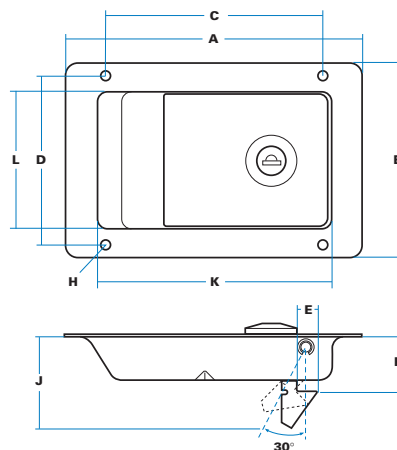

A Case length	170 mm
B Case width	110 mm
C Hole centres	100 mm
D Hole centres	99 mm
E Hook engagement	13 mm
F Hook penetration	38.5 mm
G Hook width (not shown)	30 mm
H Hole sizes (dia)	7 mm
J Maximum depth	67 mm
K Recess length	142 mm
L Recess width	82 mm

Blind-mounting models have four studs (M6x10mm) welded on inside rim. see page C19 Consult engineering drawing for position of studs



Double-sided 'FT' keys
as standard

Model illustrated is in
stainless steel with slam-
bolt and concealed fixing
studs with reversed-flap as
9/02030/RF

'DEEP-DISH' PADDLES, REVERSED-FLAP

These unique, 'reversed-flap' models offer a new solution to the problems involved with securing of top-hinged doors. Previously, the only options were to use a 'drop-T' deadbolt, or a 2-way 'paddle' system, the latter often creating difficulties with insulation material or structural members.

Fully-flush and attractively finished, the new paddles have a wide, deep aperture to suit a gloved hand. The design also allows more "pull" than with normal paddle flaps, useful with doors that can 'stick' onto heavy gasketing.

! Reversed-flap can be fitted to any of our 'deep-dish' paddle designs, mild steel or stainless. See options below. A gasket is provided.

?

- Locking or non-locking
- Stainless steel or mild steel
- Black powder-coated finish
- Slam-bolt or hook-latch operation
- Pierced rim or plain rim
- Welded studs for concealed fixing

T Tested to destruction, paddle flap withstood a direct load of 42NM (2.45KN), equivalent to a "pull" of 245Kg (540 lbs). During endurance (cycle) testing the latch was slammed/opened for over 50,000 cycles with no discernable wear.

ORDERING CODE

To order, add the suffix "RF" to our regular part numbers. Some popular (locking) models are shown below:

9/02028/RF	Stainless paddle, slam-bolt
9/02008/RF	Mild steel paddle, slam-bolt
9/02022/RF	Stainless paddle, hook-latch
9/02002/RF	Mild steel paddle, hook-latch

SPECIFICATION

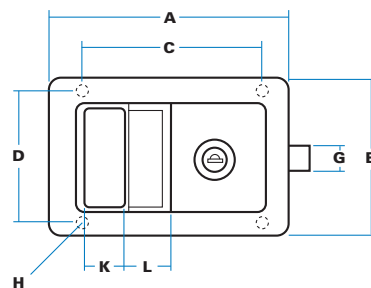
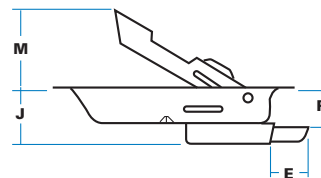

A Case length	170 mm
B Case width	110 mm
C Hole centres	100 mm
D Hole centres	99 mm
E Bolt projection (max)	28 mm
F Bolt depth	30 mm
G Bolt width	19 mm
H Hole sizes (dia)	7 mm
J Maximum depth	44 mm
K Flap length	35 mm
L Aperture length	40 mm
M Maximum flap height (30°)	60 mm

APPLICATION TO TOP HINGED DOORS

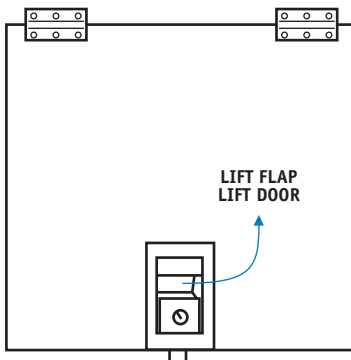

Paddle is mounted at bottom with slam-bolt or hook-latch engaging at edge of door. Paddle flap faces downwards, preventing accumulation of debris and providing easy, lifting action.



9/02041B (with hook-latch action)

ORDERING CODE

Mild steel, pierced rim & hook-action:

9/02041	Padlockable deep-dish paddle
9/02041B	As above, black finish
9/00406	Loop striker (stainless steel)

SPECIFICATION

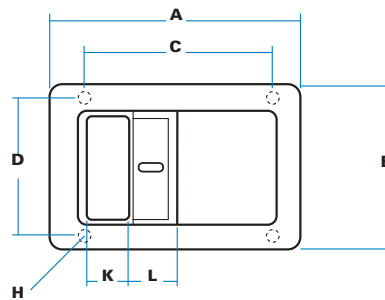
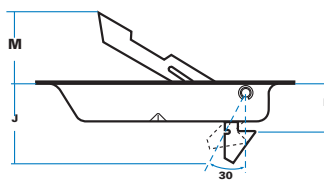

For dimensions, see pages C14-15



Double-thickness padlock loop with 10mm diameter aperture

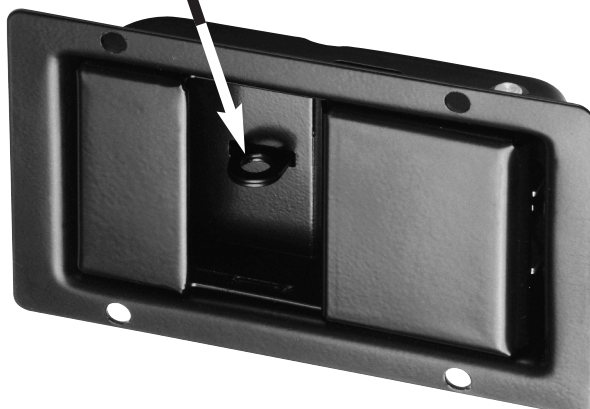

'DEEP-DISH' PADDLES, PADLOCKABLE

This new, padlockable version of our 'deep-dish' paddle latch is ideal for applications where it is necessary to visually check that compartments have been secured, or with rental equipment when the operator prefers to fit their own standard padlock.

The deep, wide case gives easy access for a gloved hand and the 'reverse flap' design means the latch gives good leverage and can be readily opened when mounted at either top or bottom of a door. The model shown has black powder-coated finish with 'hook-latch' action and open-fixing, but other options can be provided to order.

! Double-section welded steel loop in base of paddle dish allows padlock to be easily secured and prevents flap from being opened.

M Model shown has open-fixing holes, but concealed fixing provides neater appearance and greater security.

M Normally mild steel, zinc-plated or powder-coated.

- ?**
- Polished stainless steel.
 - Coloured finish
 - Hook-latch or slam-bolt operation
 - Pierced rim or plain rim
 - Welded studs for concealed fixing



9/02239
2-way full set (using stainless centre case, end latches and links).

ORDERING CODE

Stainless models with pierced rim (& gasket)

9/02238	2-way paddle centre, locking
9/02238/01	2-way paddle centre, FT111
9/02239	2-way paddle system, locking
9/02239/01	2-way paddle system, FT111
9/02236	2-way paddle centre, non-locking
9/02237	2-way paddle system, non-locking

Mild steel models with pierced rim (& gasket)

9/02248	2-way paddle centre, locking
9/02248/01	2-way paddle centre, FT111
9/02249	2-way paddle system, locking
9/02249/01	2-way paddle system, FT111
9/02246	2-way paddle centre, non-locking
9/02247	2-way paddle system, non-locking

Consult sales office for 'blind-mount' and stud fixed models

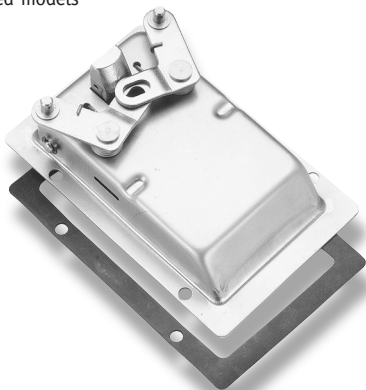

The 2-way linkage arms and rivets are made in stainless steel. The linkage bars are retained by cotter pin and washers provided.

SPECIFICATION

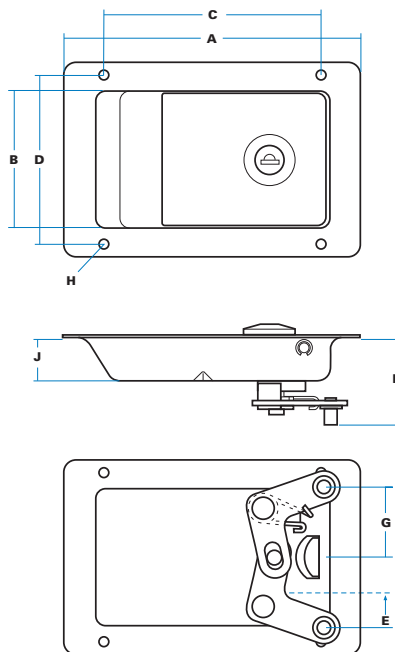

E	'Travel' of link point (each side)	15 mm
F	Depth of link points	50 mm
G	Location of link points	47 mm

All other dimensions as for 'deep-dish' paddle case (C13)

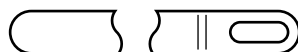

Standard linkage bar 3/12497 (915mm) used for 2-way slam system. Piercing allows 'quick fit' attachment of latches and free movement when centre is locked. Cut other end to suit.

713

'DEEP-DISH' PADDLES, 2-WAY MODELS

With this design the paddle case has an integral 2-way mechanism, allowing it to be used for slam systems on larger doors, fitted vertically or horizontally. Order as centre units only, or as full system.

! Deep dish (30 mm) with internal finger-shield and beaded edge on flap for easy operation. Stainless locking bolts slides on carrier, giving protection against flap being forced. Low-profile lock with double-sided key cylinder as standard.

W Latches slam against sides of door frame or strikers, released by lifting flap.

↕ Locking with key blocks flap, but end latches are still free to operate using 'free movement' aperture in link bar.

≡ Pierced rim, internal welded studs, or plain rim with mild steel models (for weld-on fixing). Gasket supplied.

🔑 'FT' keys as standard, with shuttered keyway. Optionally, 'FS', '92', 'DLP' or 'Ronis' key types. Non-locking models.

🔧 Polished stainless steel, or mild steel, clear zinc-plated. Optionally, black powder-coated finish.

M With stainless models, all components made in Grade 304. With mild steel models, case and flap in CR4 with mild steel slam bolt.

? Alternative end latches. 'Reverse flap' models.

Standard panel cut-out, 'Open-fix' models

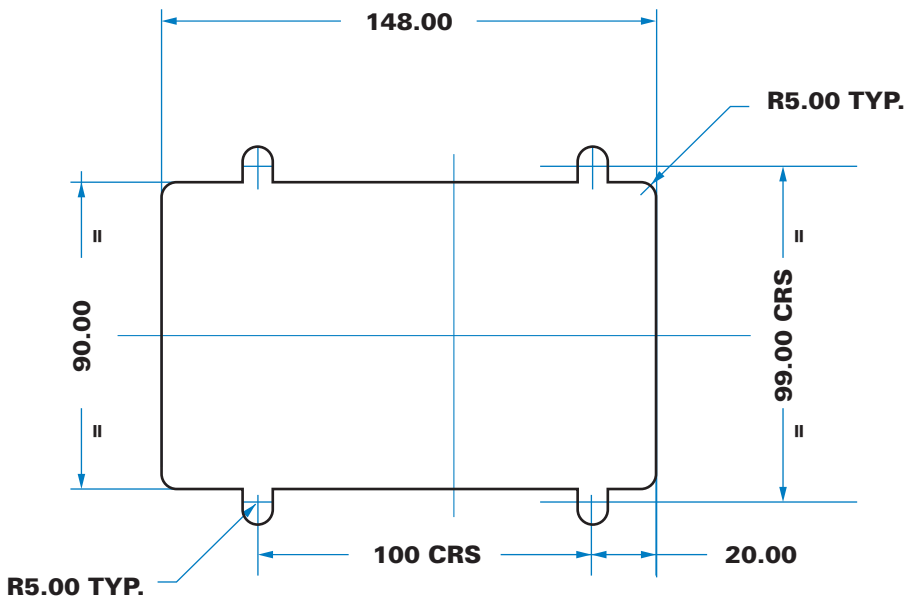

'Deep-dish' paddles, non locking versions are also available



815

'DEEP-DISH' PADDLES, STANDARD PANEL-PIERCING DIMENSIONS

The illustrations show recommended panel-piercing dimensions for 'deep-dish' paddles, both locking and non-locking models.

Open fixing versions can be mounted using M6 or 1/4 inch dome-headed bolts, (or equivalent rivets) and appropriate washers and securing nuts.

Stud-fixed models

Concealed-fixing versions have 4-off weld studs M6 x 15mm, at different positions to holes. Request engineering drawing.

Recommended maximum torque for securing weld-studs is 4.5Nm (3.3ft-lb)

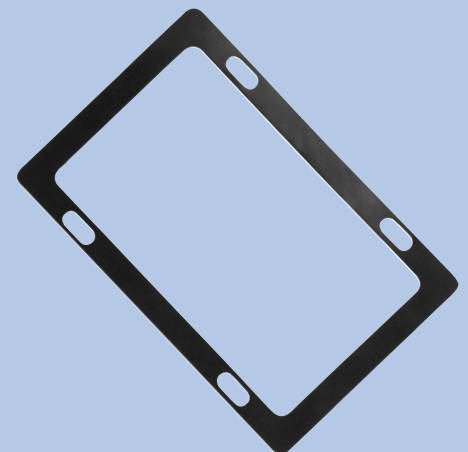

Gaslets are provided with all models.



9/02010B/IR Slam-bolt, black, with studs and gasket (also shows optional inside release knob).

'DEEP-DISH' PADDLES, WITH STUDS FOR BLIND-MOUNTING

This page illustrates an optional method of fixing from within, which gives a neat appearance, more resistant to corrosion and physical interference. 'Blind-mounting' is available with all operating models.

ORDERING CODE

Stainless models (slam-bolt), with studs

9/02030	Deep-dish paddle, locking
9/02030/01	As above, FT111
9/02031	Deep-dish paddle, non-locking

Mild steel models (slam-bolt), with studs

9/02010	Deep-dish paddle, locking
9/02010/01	As above, FT111
9/02011	Deep-dish paddle, non-locking

Stainless models (hook-latch), with studs

9/02024	Deep-dish paddle, locking
9/02024/01	As above, FT111
9/02025	Deep-dish paddle, non-locking

Mild steel models (hook-latch), with studs

9/02004	Deep-dish paddle, locking
9/02004/01	As above, FT111
9/02005	Deep-dish paddle, non-locking

A knob for inside release can be fitted to all slam-bolt models. This operates even when paddle has been locked from outside.

Add suffix "IR" to part number.

SPECIFICATION

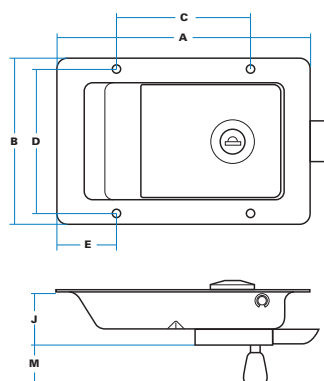

A Case length	170 mm
B Case width	110 mm
C Stud centres	90 mm
D Stud centres	99 mm
E Location	40 mm
J Maximum depth	44 mm
M Knob height	35 mm

Blind-mounting models have four studs (M6x15mm) welded on inside rim. All other dimensions shown on Page C13.

! Deep dish (30 mm) with internal finger-shield and beaded edge on flap for easy operation. Stainless locking slide on carrier, giving protection against flap being forced. Low-profile lock with double-sided key cylinder as standard.

W Slam-bolt or hooked latch operation. Also see 2-way models.

M Plain rim with internal welded studs for concealed fixing ('blind-mounting'). Gasket supplied.

K 'FT' keys as standard, with shuttered keyway. Optionally, 'FS', '92', 'DLP' or 'Ronis' key types. Non-locking models.

F Polished stainless steel, or mild steel, clear zinc-plated. Optionally, black powder-coated finish.

M With stainless models, all components made in Grade 304. With mild steel models, case and flap in CR4 with mild steel slam bolt.

? Alternative release knob on slam-bolt models. Reverse flap models.



9/01840



View of underside showing circular form & tapped bosses

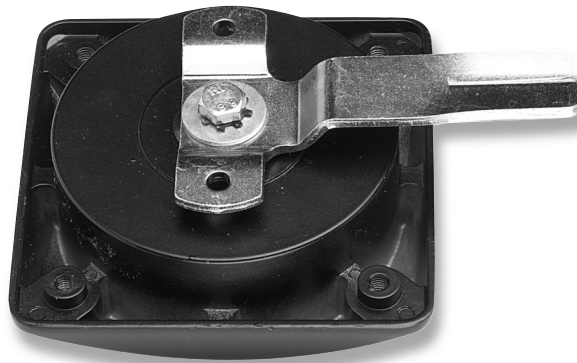

020

SEMI-FLUSH RECESS LATCH WITH FULL WATER-SEALING

Robust, one-piece latch, very easily fitted. Looks good on machinery enclosures, cabinets and inspection panels, providing highly cost-effective alternative to plant-on handles or other flush-latch systems.







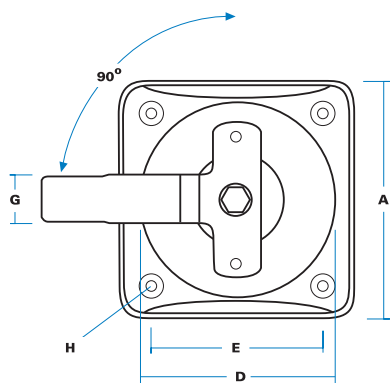
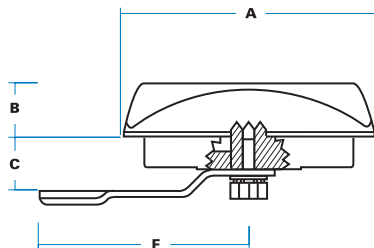

ORDERING CODE

- 9/01840 Semi-flush recess latch
- 9/01840/1 As above, FS 880 standard keys
- 9/01841 Non-locking model

SPECIFICATION



A Case length / breadth	98 mm
B Height	20 mm
C Max depth	22.5 mm
D Recess diameter	82 mm
E Hole centres	72 mm
F Engagement	82 mm
G Latch bar width	20 mm
H Hole sizes	M5 x 10 mm

-  Low profile, deep recess for finger-tip action, water-sealed, with concealed fixing. Latch bar accepts rods for 3-way action.
-  Handle operates latch bar with cam-form allowing 4mm take-up against seals.
-  Rotation 90 degrees. latch bar can be fixed in-line or at 90 degrees to handle. Totally symmetrical, non-handed.
-  Fits through 83mm diameter aperture. Secured by screws into 4-off tapped bosses.
-  "FS" keys only, with shuttered keyway. Non-locking version available.
-  Black powder-coated, with bright chromium-plated handle as standard; alternatively, all black.
-  Zinc diecast handle & base, steel latch bar, zinc plated, Nitrile seal.
-  Alternative latch bars as required.



Model 21 in 'open' mode, with handle raised and latch-bar relaxed. Note the adjustable contactor, along with 'U'-brackets to clamp latch into position.

ORDERING CODE

- 9/03000** 'Model 21' compression latch
(mixed differ 'FT'keys)
- 9/03000/01** As above, standard keys (FT111)

SPECIFICATION

See overpage for dimensions and panel piercing details



In the 'usual' arrangement for this type of latch system the contactor is positioned above the handle (as with a regular 'drop-T'). This will suit doors hinged at the side, with the latch mounted in a sideways orientation.









In this configuration the latch-bar is reversed to bring the contactor under the handle position. This is ideal for top-hinged doors and hatches, where handle lifts in the normal way while engagement takes place at the bottom face. The bar is released and secured by a hexagon bolt and securing plate



123

'MODEL 21' FLUSH FIT COMPRESSION LATCH

'Model 21' is an altogether new design in composite materials, providing a well-styled, versatile locking unit. Fixed invisibly, without ugly bolts or rivets, it allows easy adjustment with the latching point either above or below the handle, and with 6mm of 'take-up' to make an effortless seal against gasketed doors. The latch is ideal for electrical enclosures and 'visible' applications where good appearance is essential.

-  Water and corrosion resistant, with depth, direction, and 'throw' of latch changed quickly and easily to give great range of adjustment. Simple to fit, with 'U'-brackets and gasket provided.
-  Unlock and lift handle, which releases latch bar, and turn to open door. To secure, bring latch to vertical and press down on handle, which compresses bar against door-edge.
-  Latch travels 90 degrees from centre (rest) position in either direction against 'stops'. It is not 'handed'.
-  Unit fits through aperture, is clamped against panel edge by two U-brackets, and secured by M8 locknuts on 45mm bolts.
-  'FT' double-sided keys with shuttered keyway, or optionally, 'FS' keys.
-  Black, self-coloured, with lightly-textured finish. Latch bar is yellow-zinc plated for corrosion resistance
-  Shell & hub in glass-filled nylon, zinc diecast handle, latch-bar & brackets in mild steel, with cut-rubber gasket.
-  2-way and 3-way versions also available.

'Model 21' latch with
engagement below handle



21

'MODEL 21' NEW CONCEPT COMPRESSION LATCH

A truly revolutionary design which takes the central idea of the traditional 'drop-T' latch and reworks it from first principles, greatly improving both function and appearance to make this a latch fit for the 21st Century.

- Superb styling, with elegant and symmetrica oval shape.
- Turn-&-press to compress latch against a gasketed door-edge.
- Fast and easy 'invisible' fixing through simple panel cut-out, water and corrosion-resistant.
- Total flexibility in use – not 'handed', adjustable, with latching-point actually brought under the handle if desired.

SPECIFICATION

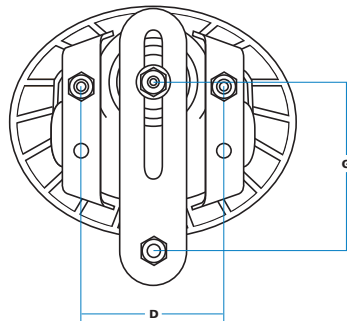
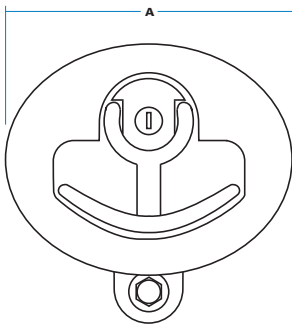

A Major diameter	150 mm
B Minor diameter	120 mm
C Maximum depth	72 mm
D Fixing centres	75 mm
E Min depth to bar	28 mm
F Max depth to bar	55 mm
G Max travel from the axis	100 mm

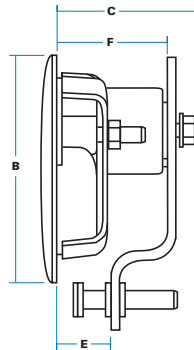

Note: Engagement range (distance below mounting surface) can range from a theoretical 2mm – 75mm

Lock series; 'FS' & 'FT' (double-sided) key types.

Materials; Shell and hub in 30% glass-filled nylon. Handle as zinc alloy diecasting, powder-coated.

Latch bar and brackets in mild steel, yellow zinc-plated.

A special latch-bar is available for 'above handle' only applications, dimension 'G' = 65mm

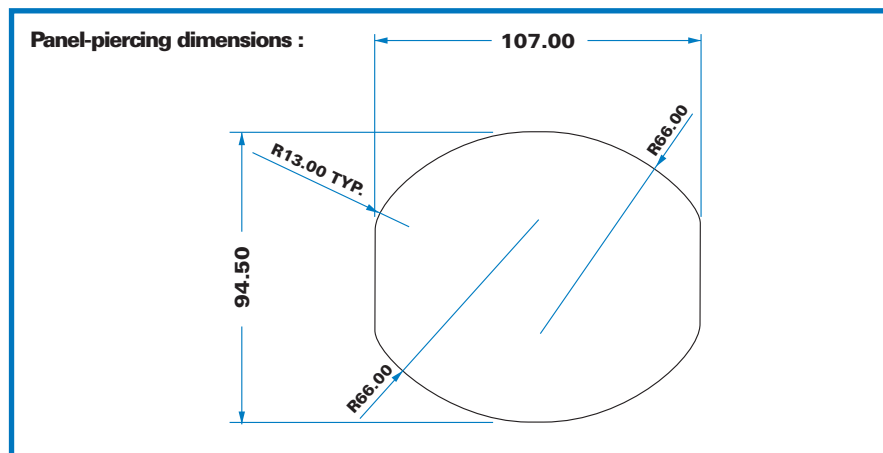

**'DROP-T'
SINGLE-POINT
LATCHES**



9/01501
Single-point model
showing standard latch bar
and adjustment nuts

Self-contained handle, lock and adjustable latch in a flush-fitting recess pan, with good resistance to water penetration. Easily fixed into a simple cut-out, with shaped latch tongue giving 3mm take-up against gasketed door edge. Stainless or carbon-steel models. Suits vehicle compartments & toolboxes, compressors, generators, other large enclosures.

! Stainless models are bright-polished for good appearance, neoprene seal under stainless 'cup' washer for weatherproofing, rubber gasket supplied as standard

W Lift handle to turn latch tongue, which is adjustable through 12mm vertically. Locks only in centre (rest) position.

↕ Latch travels 90 degrees from centre against 'stops' and is 'handed' LH or RH as specified, non-reversible.

⚙ Four holes in rim at 7.5mm diameter for bolts or rivets. Latch bar is adjusted by 2 x M10 nuts.

🔑 'FS' keys with shuttered keyway as standard. Optionally, 'FT' double-sided keys. Non-locking versions also available.

🔧 Polished stainless steel with chrome handle & hub, or carbon steel, zinc-plated. Optionally, black powder-coated. All internal parts are zinc plated for corrosion resistance.

M 'T'-pan in grade 304 stainless steel, or carbon steel to CR4. Handle, hub and support bracket are zinc diecast.

? Alternative latch bars. Weathershield options. 'Blind mounting'.

Panel
Piercing



ORDERING CODE

Stainless Steel Models

9/01501 LH, locking (Mixed differ)

9/01502 RH, locking (Mixed differ)

9/01503 LH, standard-key FS880

9/01504 RH, standard-key FS880

Mild Steel models

9/01511 LH, locking (Mixed differ)

9/01512 RH, locking (Mixed differ)

9/01513 LH, standard-key FS880

9/01514 RH, standard-key FS880

Non-locking models shown opposite

SPECIFICATION

Standard model with 'cranked down' latch bar.

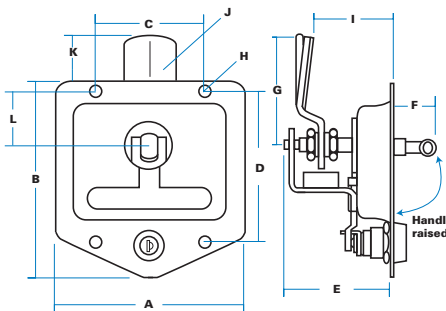

A Width of pan	120 mm
B Length of pan	125 mm
C Hole centres	69 mm
D Hole centres	95 mm
E Max. depth	68 mm
F Height of handle	30 mm
G Length of latch	70 mm
H Hole Size (dia)	7.5 mm
I Engagement (normally set at 51 mm)	43-55 mm
J Width cam travel 3 mm depth	30 x 5 mm deep
K Projection	30 mm
L Location	34 mm
'T' dimension can be varied using different latch bars. See options.	
Gasket ref: MP00450 (locking)	

Direction of Movement

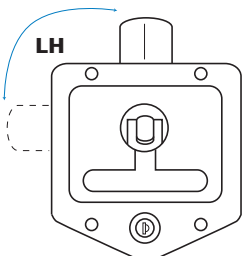

Handle turns anticlockwise to release the latch tongue

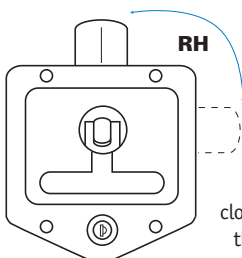

Handle turns clockwise to release the latch tongue

9/01505
Single-point model in
'rest' position.

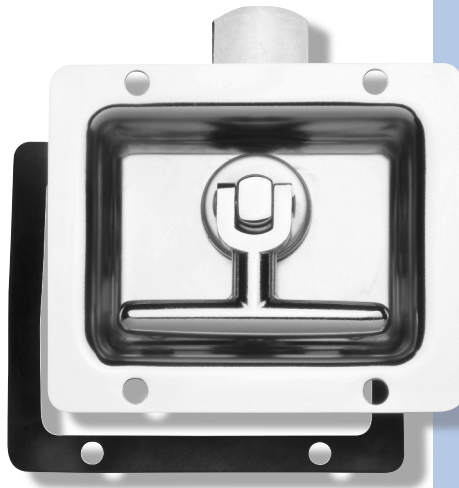

424

'DROP-T' NON-LOCKING LATCHES

Identical in function to locking models, but with no lock cylinder and reduced pan dimensions.

These are used when no security is required or where free-opening is mandatory (fire equipment, etc).

ORDERING CODE

Stainless Steel Models

9/01505 LH, non-locking, stainless steel

9/01506 RH, non-locking, stainless steel

Mild Steel Models

9/01515 LH, non-locking, zinc-plated

9/01516 RH, non-locking, zinc-plated

SPECIFICATION

Standard model shown with 'cranked down' latch bar

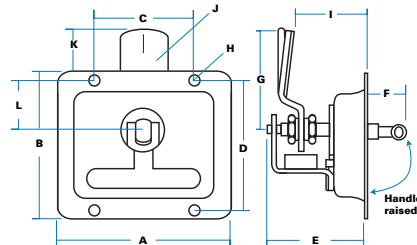

Directions of Movement

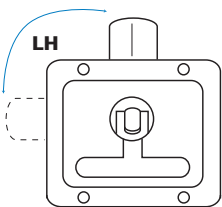

Handle turns anticlockwise to release the latch tongue

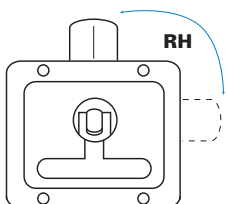

Handle turns clockwise to release the latch tongue

A Width of pan	120 mm
B Length of pan	102 mm
C Hole centres	69 mm
D Hole centres	90 mm
E Max. depth	68 mm
F Height of handle	30 mm
G Length of latch	70 mm
H Hole Size (dia)	7.5 mm
I Engagement (normally set at 51 mm)	43-55 mm
J Width 30 x 5 mm deep cam travel 3 mm depth	
K Projection	30 mm
L Location	34 mm
T dimension can be varied using different latch bars. See options	
Gasket ref: MP00568 (non-locking)	

! Polished diecast 'hub', and neoprene seal under stainless 'cup' washer for good appearance, corrosion resistance and weatherproofing. Gasket supplied.

W Lift handle to turn latch bar, with 5 mm cam-form, adjustable through 12 mm vertically.

↕ Latch travels 90° from centre (rest) position against 'stops' and is 'handed' LH or RH (not reversible).

⚙ Four holes in flanges at 7.5 mm diameter. Latch bar is adjusted by 2 x M10 nuts.

🔧 Polished stainless steel with chrome handle and hub, or mild steel, zinc-plated. Optionally, black powder-coated. All internal parts are zinc plated for corrosion resistance.

M 'T'-pan in 2mm stainless steel grade 304, bright polished, or mild steel to CR4. 'T'-handle and hub are zinc diecast.

Panel Piercing

C30

9/01501/SF Drop-T with stud-fixing, also showing rubber gasket and diecast support bracket

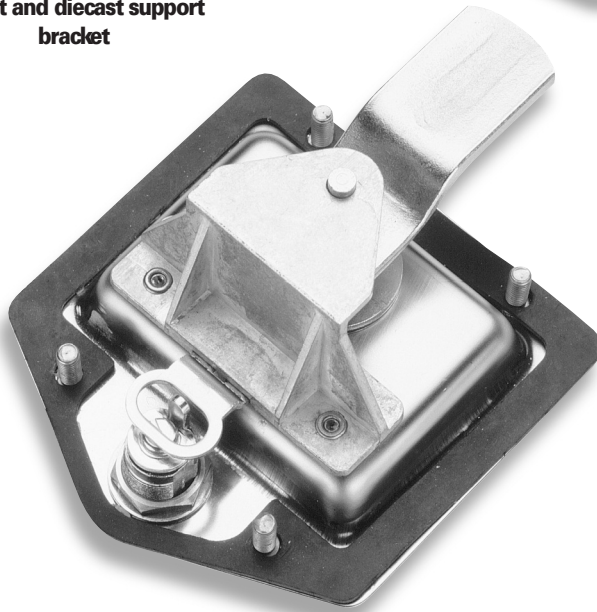

'DROP-T' MODELS WITH STUD-FIXING

This is an optional feature which allows the 'Drop-T' unit to be secured from beneath, with no mounting holes, screws or rivets visible from outside.

Four weld-studs (M6 x 15 mm) are fitted to the flanges in same positions as normal mounting holes, giving better appearance, more security, and preventing entry of corrosion-causing agents.

Stud-fixing is an option on all 'Drop-T' models, including mild steel and powder coated versions.

ORDERING CODE

Stud-fixing models
Add the suffix "/SF" to our regular part numbers.

SPECIFICATION

Fixing centres as pierced models.
Recommended maximum torque for securing weld-studs is 4.5 Nm (3.3 ft lb)

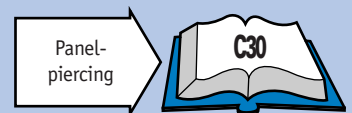

Drop-T with straight latch bar

Suffix 'A'
'T' dimension variable
from 29-41 mm,
'Nominal' = 35 mm

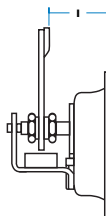

Specify LH or RH
5/02068 = RH
5/02069 = LH

Drop-T with long, straight latch bar

Suffix 'C'
'G' dimension is
100 mm
('K' is 60 mm)

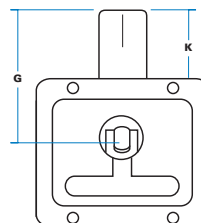

Specify LH or RH
5/02431 = RH
5/02432 = LH

Drop-T with 'cranked-up' latch bar

Suffix 'B'
'T' dimension variable
from 21-33 mm,
'Nominal' = 30 mm

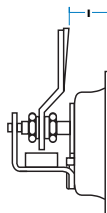

Specify LH or RH
5/02070 = RH
5/02071 = LH

Drop-T with straight, hooked latch bar

Suffix 'D'
'G' dimension (to
hook edge) is 65 mm.

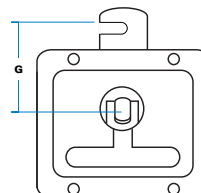

Specify LH or RH
5/02058 = RH
5/02059 = LH

'DROP-T' ALTERNATIVE LATCH BARS

Standard models use 'cranked-down' latch bars but various options are illustrated. These are not reversible and cannot be changed after assembly. All are 5 mm thick with 3 mm 'V'-raised cam form. (Use the suffix letters shown to specify the latch bar required.)

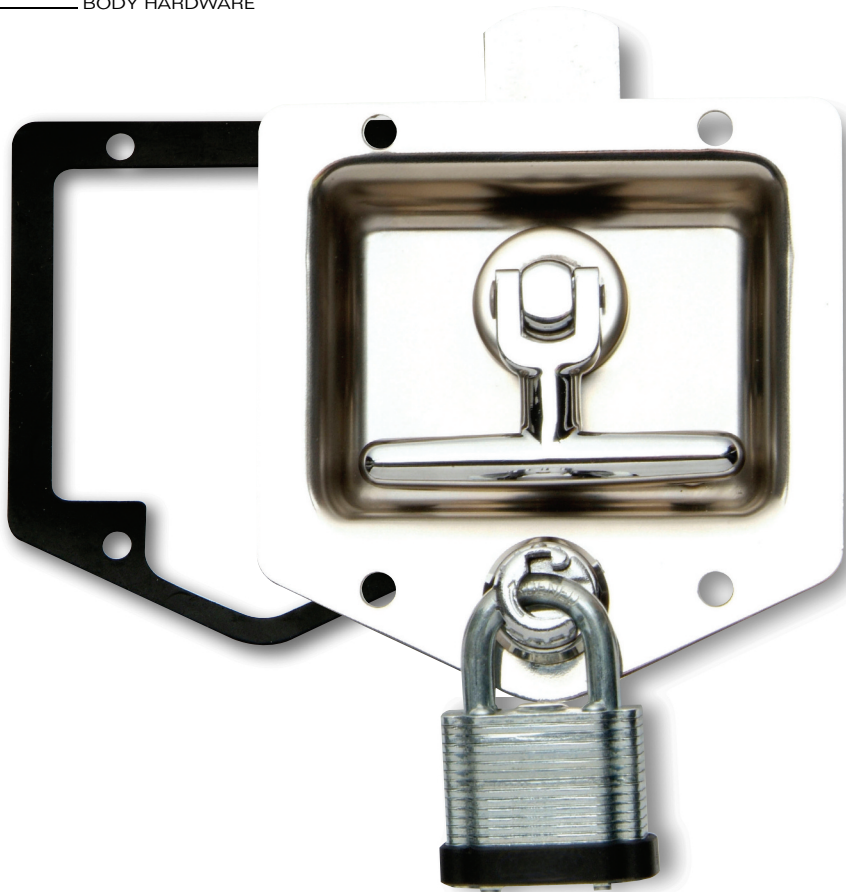

C30

'DROP-T' PADLOCKABLE MODELS

Identical in function and dimensions to standard locking models, but allowing a padlock to be fitted. This is ideal when it is necessary to visually check that compartments have been secured, and with rental equipment when the operator prefers to fit their own standard padlock.

All of the regular options are available but a diecast, spring-loaded knob replaces the usual lock cylinder. To order, add the suffix '/PL' to the normal part number.

! Stainless models are bright-polished for good appearance, with neoprene seal under stainless 'cup' washer for weatherproofing, and rubber gasket supplied as standard.

W Lift handle to turn latch tongue. Return to centre (rest) position and fold down. To lock, turn diecast knob through 180° then depress top plunger and insert padlock through aperture. The handle now cannot be turned and the latch is held rigid.

↕ Latch travels 90° from centre against 'stops' and is 'handed', LH or RH, as specified, non-reversible.

W Four holes in rim at 7.5mm diameter for bolts or rivets. Latch bar adjusted by 2 x M10 nuts.

W Polished stainless steel with chrome handle, hub and knob, or carbon steel, zinc plated. Optionally, black powder-coated. All internal parts are zinc-plated for corrosion resistance.

? Alternative latch bars, 2-way & 3-way operation, 'Blind mounting' with weld-studs

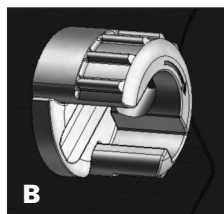
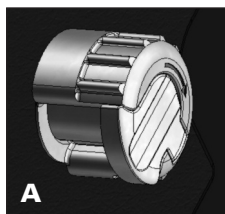

**View A shows knob in 'rest' position.
View B shows the top section retracted
to allow entry of padlock shackle**

ORDERING CODE

Add suffix "/PL" to regular part number

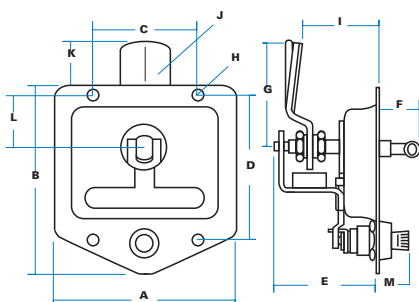

SPECIFICATION

A Width of pan	120 mm
B Length of pan	125 mm
C Hole centres	69 mm
D Hole centres	95 mm
E Max depth	68 mm
F Height of handle	30 mm
G Length of latch	70 mm
H Hole sizes (dia)	7.5 mm
I Engagement (normally set at 51mm)	43-55 mm
K Projection	30 mm
L Location	34 mm
M Height of Knob	25 mm

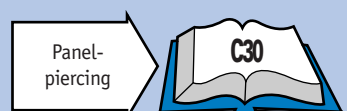

- Complete system, supplied with rods and guides
- Assembled and 'handed' on site
- Stainless steel or zinc-plated



Single-sided 'FS' keys as standard

ORDERING CODE

9/01561	3-way Drop-T set, stainless, mixed differ, c/w rods
9/01561/01	As 9/01561, FS880
9/01562	3-way Drop-T set, mild steel, mixed differ, c/w rods
9/01562/01	As 9/01562, FS880
9/01567	Centre only, 3-way Drop-T, stainless
9/01567/01	As 9/01567, FS880
9/01568	Centre only, 3-way Drop-T, mild steel
9/01568/01	As 9/01568, FS880

Non-Locking models shown opposite

Direction of Movement

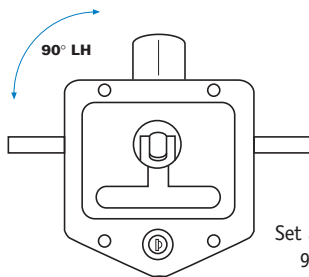

Set at factory for 90° LH but 'stops' are reversible on site

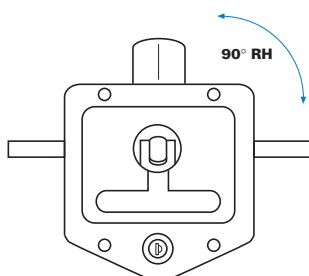

SPECIFICATION

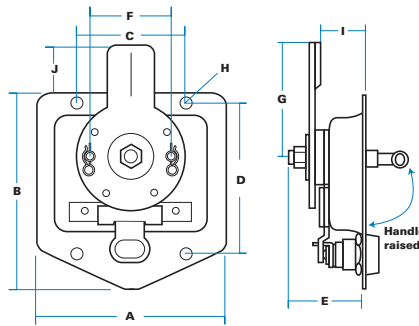

A Width of pan	120 mm
B Length of pan	125 mm
C Hole centres	69 mm
D Hole centres	95 mm
E Max depth	45 mm
F Rod fixing centre	52 mm
G Length of latch Cam depth	70 mm 3 mm
H Hole sizes (dia)	7.5 mm
I Engagement	27 mm
J Visible length	30 mm

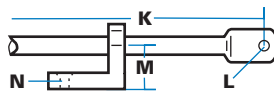

K Rod length	1145 x 9.5 mm
L Hole dimension	(dia) 7.5 mm
M height to central line	14 mm
N Hole sizes	(dia) 5mm c/s 10 mm

Rods withdraw by 25mm in line of travel, as latch disc rotates through 90°.

Rod Ref (3/18702) Guides Ref (3/18716)

123

'DROP-T' 3-WAY LATCH SYSTEM

The 3-way 'Drop-T' provides a complete latching system for the largest doors. Handle, lock, latch and flush recess pan form a self contained unit needing only a simple cut-out. Rods attached on site and adjustable for either LH or RH movement. Suits drop-down hatches, truck toolboxes and other large enclosures.



Polished diecast 'hub', and neoprene seal under stainless 'cup' washer for good appearance, corrosion-resistance and weatherproofing.



Lift handle to turn, releasing latch tongue and withdrawing rods. Reverse to close. Tongue has 3mm cam-form for easy engagement.



Latch travels 90° from centre against 'stops', which can be adjusted to allow either LH or RH operation.



Four holes in flanges at 7.5mm diameter. Rods are secured by split pins through pillar rivets.



'FS' keys as standard, with shuttered keyway. Optionally 'FT', '92' or 'DLP' keys.



Polished stainless steel with chrome handle and hub, or mild steel, zinc-plated. Optionally, black powder-coated.



'T' pan in 2mm stainless steel, Grade 304, bright polished, or mild steel to CR4, zinc-plated. 'T' handle and hub are zinc diecast, polished and chromium-plated or zinc-plated.



Special rod lengths. Plain flanges or 'blind-mounting' with M6 welded studs. Non-locking and 2-way models, cranked tongues, etc. Weathershield options.

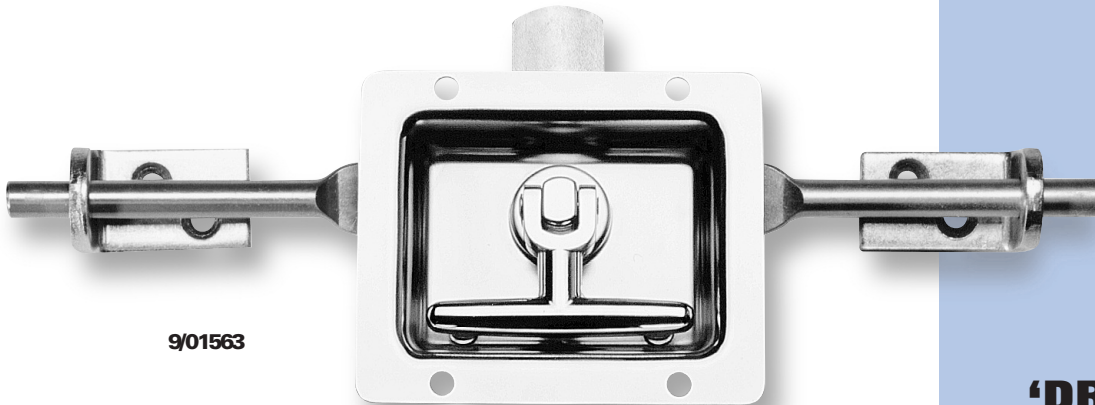

9/01563

'DROP-T' 3-WAY NON LOCKING LATCH SYSTEM

The multi-point 'Drop-T' is available as non-locking versions, usually with centre latching tongue and rods. Rods attached on site and adjustable for either LH or RH movement.

! Polished diecast 'hub', and neoprene seal under stainless 'cup' washer for good appearance, corrosion-resistance and weatherproofing.

W Lift handle to turn, releasing latch tongue and withdrawing rods. Reverse to close-tongue has 5mm cam-form for easy engagement.

↕ Latch travels 90° from centre against 'stops', which can be adjusted to allow either LH or RH operation.

🔧 Polished stainless steel with chrome handle and hub, or mild steel, zinc-plated. Optionally, black powder-coated finish.

ORDERING CODE

9/01563	3-way Drop-T set, stainless, non locking, c/w rods
9/01564	3-way Drop-T set, mild steel, non locking, c/w rods
9/01569	Centre only, 3-way, stainless, non locking
9/01570	Centre only, 3-way, mild steel, non locking

SPECIFICATION

A Width of pan	120 mm
B Length of pan	100 mm
C Hole centres	69 mm
D Hole centres	90 mm
E Max depth	45 mm
F Rod fixing centre	52 mm
G Length of latch Cam depth	70 mm 3 mm
H Hole sizes (dia)	7.5 mm
I Engagement	27 mm
J Visible length	30 mm
K Rod length	1145 x 9.5 mm (dia)

Rods withdraw by 25mm in line of travel, as latch disc rotates through 90°.

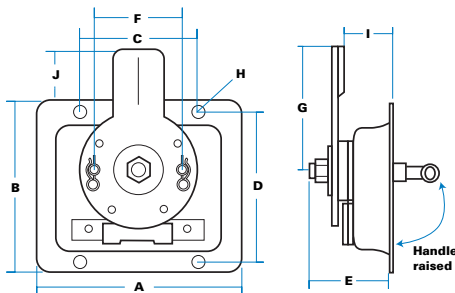

LATCH TONGUE OPTIONS

Tongues have 3mm cam-form

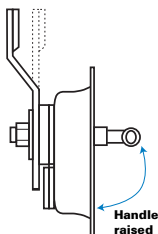

'Cranked down'
3-way tongue can be shaped to increase 'I' dimensions
Suffix A
I=32mm
Suffix B
I=37mm

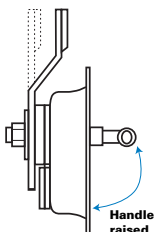

'Cranked up'
3-way tongue can be shaped to reduce 'I' dimensions
Suffix C
I=22mm
Suffix D
I=17mm

Illustration shows 3-way centre with tongue cranked down to 37mm. Also visible are pillar-rivets for attachment of rods, and screws to set 'L' or 'R' movement

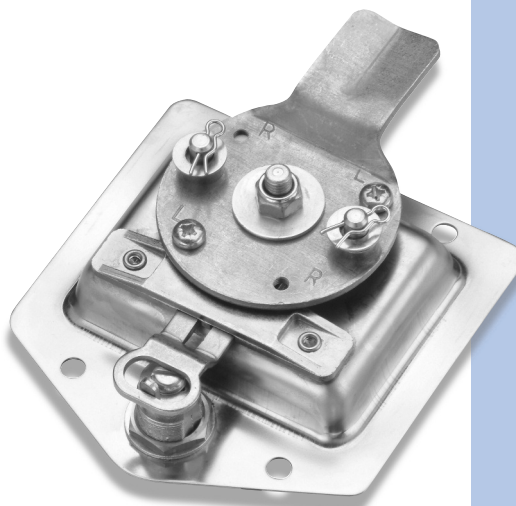

LATCH TONGUE OPTIONS

The standard multi-point latch tongue can be cranked to give a number of options, providing engagement depths between 17-37mm in 5mm increments. However this is not adjustable and cannot be varied on site. (Use the suffix letters shown to specify the latch bar required.)



9/01621
2-way slam latch
system

'DROP-T' 2-WAY MODELS

With multi-point versions the centre latching tongue can be removed to provide 2-way action only. The centre case can then be used with rods, or with standard end latches as illustrated. Adjustable for either LH or RH movement.

! Polished diecast 'hub', and neoprene seal under stainless 'cup' washer for good appearance, corrosion-resistance and weatherproofing.

W Use with 10mm rods as a 'deadbolt' latch or with end-latches and link bars as a 2-way slam system.



'DROP-T' WITH 'WEATHERSHIELD' LOCKS

Where additional protection is desired for the lock cylinder, the 'drop-T' can be fitted with a protective cover. Two styles are available, either a sliding diecast plate (chrome) or a moulded flip-up cap illustrated. They can be used with all 'drop-T' models.

ORDERING CODE

9/01621	2-way Drop-T slam system, stainless case, mixed differ.
9/01621/01	As above FS880
9/01622	2-way Drop-T slam system, mild steel case, mixed differ.
9/01622/01	As above FS880
9/01623	2-way centre only, stainless, mixed differ.
9/01623/01	As above FS880
9/01624	2-way centre, mild steel, mixed differ.
9/01624/01	As above FS880
3/18702	Rod only, 1145mm

Non-locking models also available.

Slam systems include end-latches and (flat) link bars, normally in mild steel.

SPECIFICATION

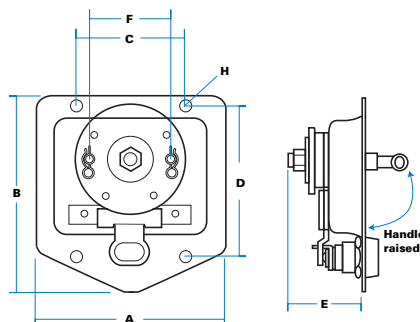

A Width of pan	120 mm
B Length of pan	125 mm
C Hole centres	69 mm
D Hole centres	95 mm
E Max depth	45 mm
F Fixing centres	52 mm
H Hole sizes (dia)	7.5 mm



'Drop-T' with flip-up moulded cap 9/00928

To order, add suffix "/MC" to our normal part number.



'Drop-T' with sliding weathershield cover, using lock 7/08996

To order, add suffix "/WS" to our normal part number.

Panel Piercing - Locking Models

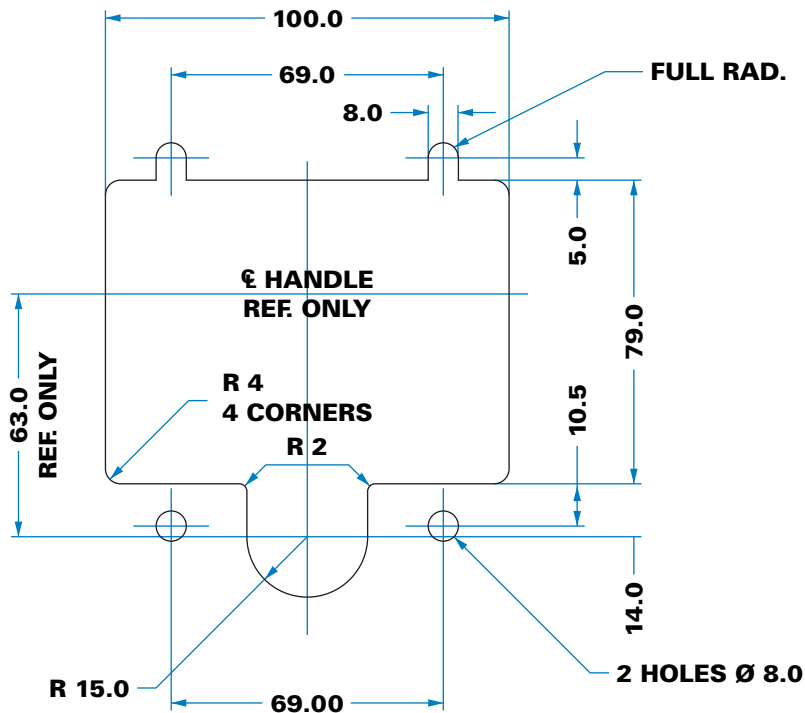

Panel Piercing - Non-locking Models

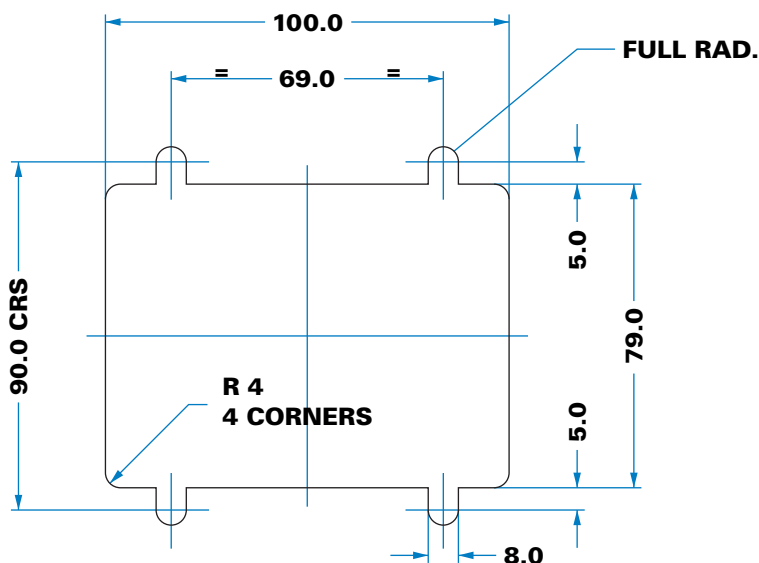

**‘DROP-T’ MODELS
STANDARD
PANEL-PIERCING
DIMENSIONS**

The illustrations show recommended panel-piercing dimensions for all models of ‘Drop-T’ latches, both locking and non-locking models.

Open fixing versions can be mounted using M6 or 1/4 inch dome-headed bolts, (or equivalent rivets) and appropriate washers and securing nuts. Concealed-fixing versions have 4-off weld studs, M6 x 15mm, at same positions.

**‘DROP-T’ WITH
SQUARE SHAFT**

To special order our drop-T models can be supplied with an 8mm-square shaft rather than with latch bar. Enquire to sales office (Ref:9/01571, etc)

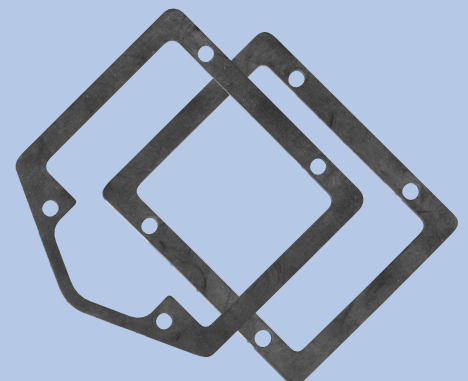

Gaslets are provided with all ‘Drop-T’ models.

ORDERING CODE

Standard Models

9/02058	2-way system complete, RH
9/02059	2-way system complete, LH
9/02060	2-way mechanism only, RH
9/02061	2-way mechanism only, LH

Special ('historic') models

3/02858	2-way system complete, RH
3/11048	2-way mechanism only, RH

Note

'Historic' models have mechanism length at 1320 mm and 'F' dimension 57 mm, and must use end-latches 3/22386.

Right-hand illustrated

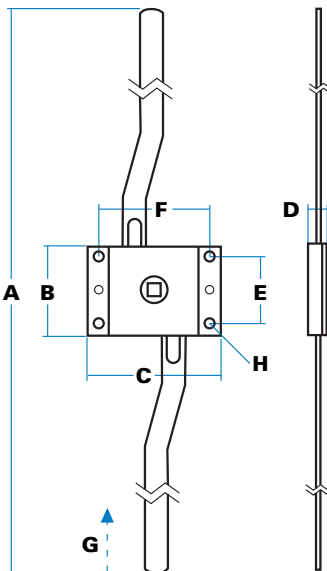

SPECIFICATION

A. Length of system (extended)	2000 mm
(retracted)	1950 mm
B. Case length	50 mm
C. Case width	75 mm
D. Case height	14 mm
E. Hole centres (vertical)	38 mm
F. Hole centres (horizontal)	62 mm
G. Withdrawal (each end)	25 mm
H. Hole sizes (diameter)	4 mm

With end latches attached, maximum system length is 2120 mm.

Dimensions of end latches (3/22387) shown separately.

Full system includes end-latches (3/22387)

Striker plates (3/12341), rivets (19-7), and wave washer (58-21).



Complete right-hand slam system 9/02058 (includes all items shown) shown fully extended from inside.

133

2-WAY SLAM SYSTEMS

The standard model illustrated is representative of a family of 2-way centre mechanisms, used with our end latches to provide slam action on two sides of a door or panel. Right-hand and left-hand systems are available, with many options to suit (volume) applications.



System slams shut, is opened by inside/outside handle or T-key. It can be slammed even when handle is locked, due to 'free movement' allowed by link bars.



Rotation of centre follow-bush (8 mm) withdraws link bars and slam bolts. System is handed by direction of rotation of follow bush and position of bars.



System is fully plant-on. Plain end of bars should be cut and drilled as required : rivets and washers are supplied with kit. Bolt pull length adjustable.



Zinc-plated throughout.



- Special link bars to order
- Permanently-attached inside handle
- 'Male drive' (8 mm square) spindle on inside/outside of latch.
- Alternative end latches
- Case hole dimensions (F = 57 mm)





Right hand centre (3/12507), shown with attachment points fully extended.

2-way centre (3/12508) is identical, but without centre bolt.

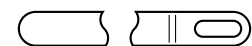
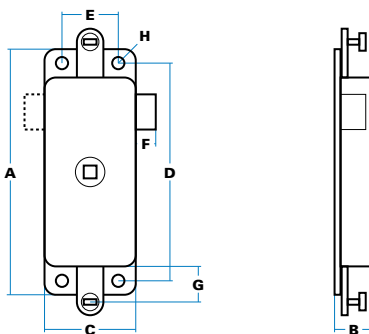
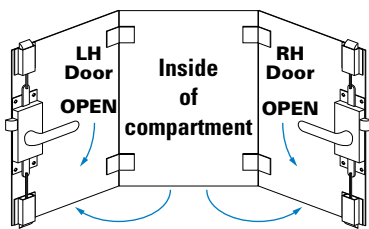

Standard linkage bar 3/12497, used on 3-way slam system

ORDERING CODE

3/12506	3-way slam centre, LH
3/12507	3-way slam centre, RH
3/12508	2-way slam centre, RH
3/12509	2-way slam centre, LH
3/12497	Linkage bar (915mm)

SPECIFICATION

A Length	127 mm
B Height	19 mm
C Width	45 mm
D Hole Centres	114 mm
E Hole Centres	28 mm
F Bolt projection	11 mm
G Length	Extended 21 mm Withdrawn 14 mm
H Hole Sizes (diameter) c/s 8 mm	Ø 5.5 mm

Follow bush accepts 8 mm square shaft from both sides.

Rotation 40° to fully withdraw centre bolt and links, direction of rotation as shown in diagrams.

Materials: Case and follow bush, zinc diecastings. All other components are mild steel.

2/3

2/3-WAY SLAM CENTRES

An exceptionally neat and compact unit which is used to make up 2-way or 3-way slam systems. 'Quick-fit' attachment points on case allow link bars to be quickly and easily attached, (generally with slam latches 3/22387). The integral slam-bolt provides centre-latching when fitted.

LEFT AND RIGHT 'HANDS'

A new, left-hand version has recently been developed to suit European and U.S. requirements where fittings are normally on the left-side rear doors.



System can be slammed-shut even when an exterior handle is in 'locked' position. Attached slam bolts (adjustable) will return links to extended position.



Rotation of follow-bush (as shown) withdraws slam bolt fully into case, also withdraws links by 7mm at each end, which operate (attached) slam latches. Unit is 'handed' by position of centre bolt and by direction of rotation of follow-bush (and operating handle).



Zinc-plated as standard. Optionally, case can be polished and chromium plated.



Centre-bolt omitted for 3/12508/9. Bolt can be reversed or extended to special request but bolt will withdraw to 11mm only.

A new left-handed version has recently been developed to suit European and U.S. requirements where fittings are normally on the left-side rear doors.

ORDERING CODE

3/18341	3-way slam system, left-hand
3/18342	3-way slam system, right-hand
3/18343	2-way slam system, right-hand
3/18344	2-way slam system, left-hand

Normally supplied in boxed sets of 10 units. All components are provided, including guides (3/18617), strikers (3/12341), rivets (19-7) and wave washers (58-21).

SPECIFICATION

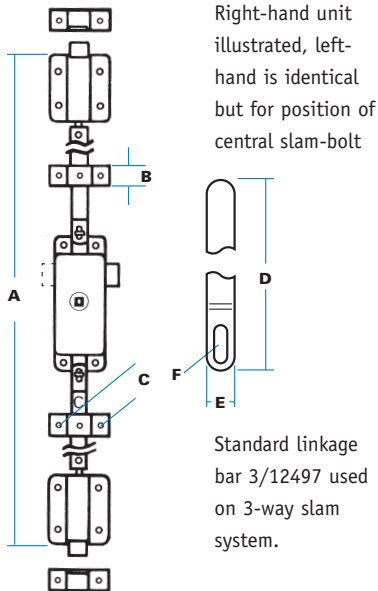

A. Max. Length of system	2057 mm
B. Guide plate width	25 mm
C. Guide hole centres	40 mm
D. Length of linkage bar	915 mm
E. Linkage bar section	12 x 3 mm
	Cranked 5 mm (rolled edges)
F. 'Free movement' slot	22 mm

All other dimensions shown on individual component pages. Centre bolt withdraws by 11 mm maximum.



Complete right-hand assembly 3/18342 (includes all items shown)





Latch is shown as mounted on inside of panel.



2/3-WAY SLAM SYSTEMS

These versatile systems are assembled on site from standard end-latches, together with centre case (opposite) and connecting bars. The three slam bolts act together and are withdrawn simultaneously.

Left and right-hand versions are identical apart from position of centre bolt and direction of rotation of centre follow-bush. 2-way versions do not have centre slam-bolt.

-  System slams shut, is opened by inside/outside handle or T-key. It can be slammed even when handle is locked, due to 'free movement' allowed by link bars.
-  Rotation of centre follow-bush withdraws slam bolt fully into case, also withdraws links at each end, which operates slam latches. System is handed by position of centre-bolt and direction of operation of follow-bush.
-  Components are fully plant-on, with 'quick fit' attachment of link bars to centre case. Plain end should be cut and drilled as required: rivets and washers are supplied with kit.
-  Zinc-plated throughout.
- 
 - Centre bolt omitted for 3/18343
 - Bolt can be reversed or extended to special request.
 - Alternative end latches
 - Special link bars to order

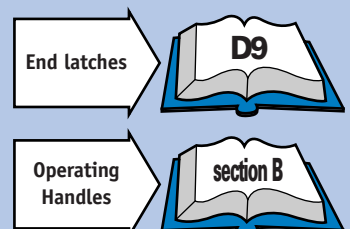



9/01050
Centre case only
(shown with links
fully extended)

1/29624
Round rod
(1100mm length)

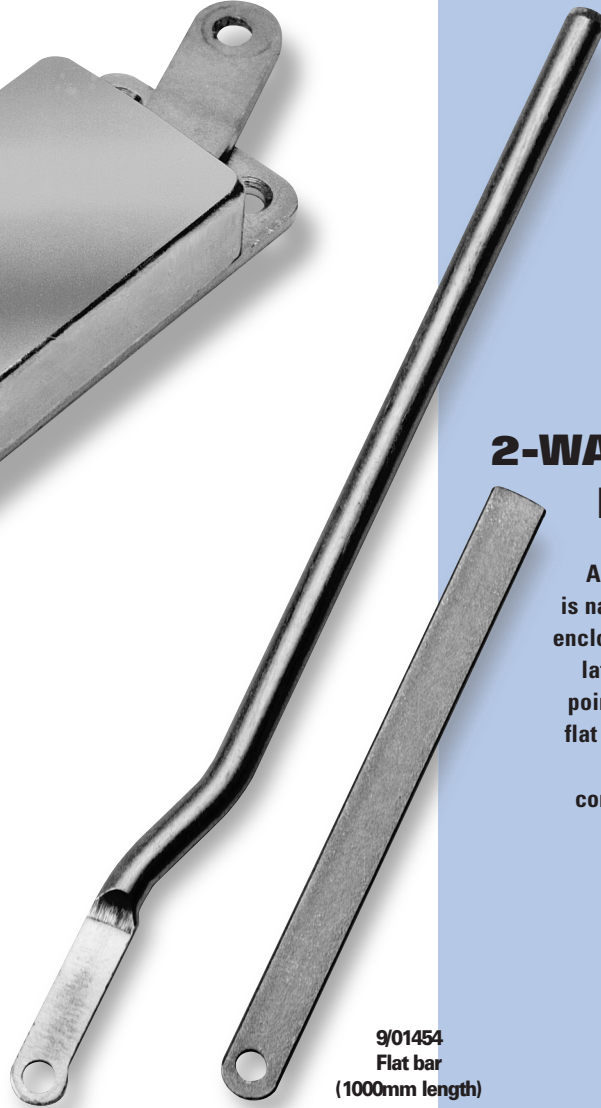

9/01454
Flat bar
(1000mm length)

2-WAY DEADBOLT MECHANISM

A 2-way 'conformity' latch that is narrower and more completely enclosed than standard 2-way rod latches, with easily accessible points for attachments of rods or flat bars and fully in-line 'throw'.

Used for roller shutters, compartments and larger doors.

ORDERING CODE

9/01050	2-way centre case only
9/01051	2-way centre c/w rods
1/29624	Rod only, 9.5mm dia. x 1100mm
9/01454	Flat bar 13 x 3mm, length 1000mm

SPECIFICATION

A Length	127 mm
B Height	19 mm
C Width	45 mm
D Hole Centres	114 mm
E Hole Centres	28 mm
F Holes Sizes (Diameter), c/s 8mm	5.5 mm
G Length Of Links	Extended 35 mm Withdrawn 20 mm
H Hole Size	7 mm

Follow bush accepts 8mm square shaft from both sides.

Rotation 90° anti-clockwise to fully withdraw links.

Materials: Case and follow bush, zinc diecastings. All other components are mild steel.

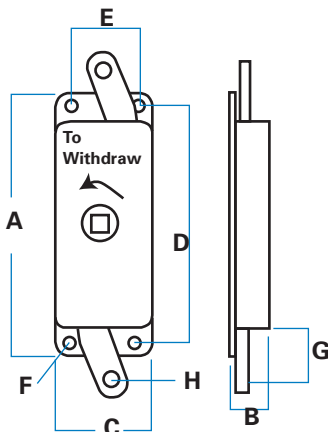

Centre bush drives links positively, no spring-return action is involved.



Rotation of follow-bush 90° anti-clockwise will withdraw links by 15 mm. Clockwise rotation extends links and holds them in place by over-centre action.



Four countersunk holes in backplate (5.5 mm, c/s 8 mm) secure unit to panel.



Zinc-plated as standard. Optionally case can be polished and chromium plated.



Full system supplied with 9.5 mm rods attached as 9/01051. Flat bars can be supplied separately or fully-attached as required. Centre case can be fitted with captive 8mm square shaft and permanently-attached inside handle.

ORDERING CODE

3/18794	2-way rod latch, RH, (set)
3/18795	2-way rod latch, LH (set)
3/18794 MO	2-way latch, RH, no guides
3/18795 MO	2-way latch, LH, no guides
3/18899	Guide, 2-way latches
3/18898	Packing-plate for guides

Right-hand illustrated

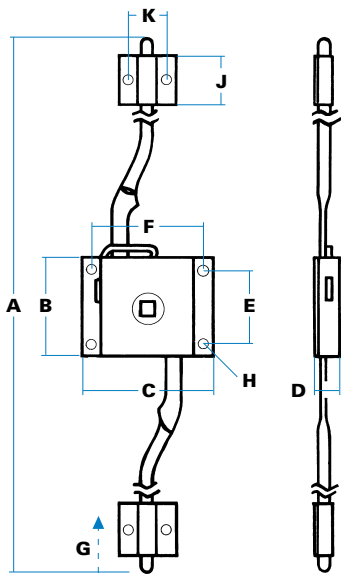

SPECIFICATION

A. Length of system (extended)	2210 mm
(retracted)	2160 mm
B. Case length	50 mm
C. Case width	67 mm
D. Case height	14 mm
E. Hole centres (vertical)	38 mm
F. Hole centres (horizontal)	57 mm
G. Withdrawal (each end)	24 mm
H. Hole sizes (diameter)	4 mm
J. Guide length	25 mm
K. Hole centres	22 mm

Rod diameter 10 mm. Follow bush mounted centrally to accept 8 mm square shaft.

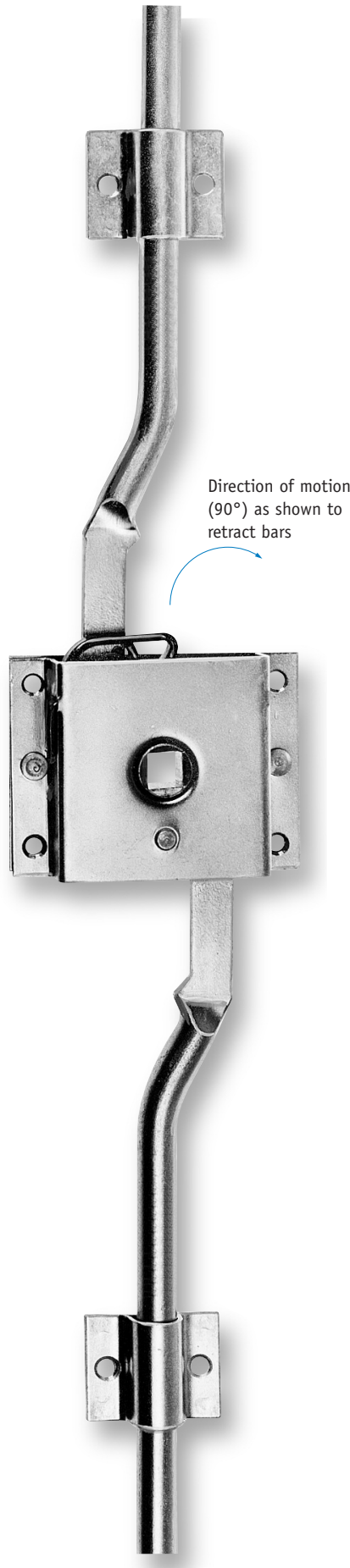
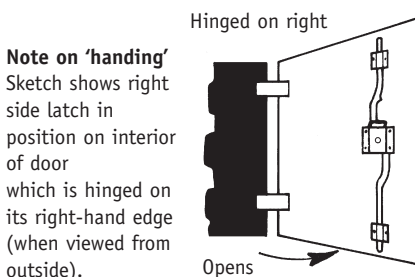

Right-hand rod latch 3/18794 (includes guides) shown fully extended, from inside.



2-WAY ROD LATCHES

Again, a design which is an industry-standard for securing large doors requiring latching on two edges. This is a 'deadbolt' system with 10 mm diameter rods driven by centre bush, and held extended by action of a strong spring. Right-hand and left-hand models are available, with many special options.

- Close door, turn inside/outside handle (or T-key) to 'throw' rods past door edge. System cannot be slammed.
- Centre bush rotates through 90° as shown to withdraw rods by 24 mm (each end). System is 'handed' by direction of rotation.
- Latches are fully plant-on. Rod ends should be cut as required: guides are supplied with full system.
- Zinc-plated throughout.
- Special rod lengths to order
 - Permanently-attached inside handle
 - 'Male drive' (8 mm square) spindle on inside/outside of latch.
 - Case hole dimensions (F = 62 mm)



ORDERING CODE

3/18238 3-way rod latch, RH, (set)

3/18254 3-way rod latch, LH, (set)

3/18238 MO 3-way latch RH,
no guides/keepers

3/18254 MO 3-way latch LH,
no guides/keepers

3/18702 Rod only, 1145 mm length

3/18716 Guide, 3-way latches

3/18722 'Keeper', 3-way latches

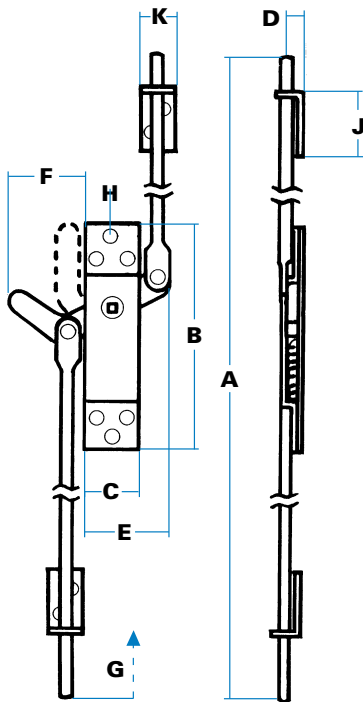

SPECIFICATION

A. Length of system (extended)	2264 mm
(retracted)	2230 mm
B. Case length	145 mm
C. Case width	36 mm
D. Height to rod centre	15 mm
E. Rear projection	57 mm
F. Front projection (extended)	54 mm
(retracted)	21 mm
G. Withdrawal (each end)	33 mm
H. Hole sizes (diameter) 6 mm, c/s 9 mm	
J. Guide plate length	40 mm
K. Guide width	25 mm

'Keeper' dimensions 120 x 25 mm, maximum height 12 mm, hole centres 101 mm
Centre 'tongue' & guide thickness, 4 mm
Rod dimensions : 10 mm dia. x 1145 mm length.

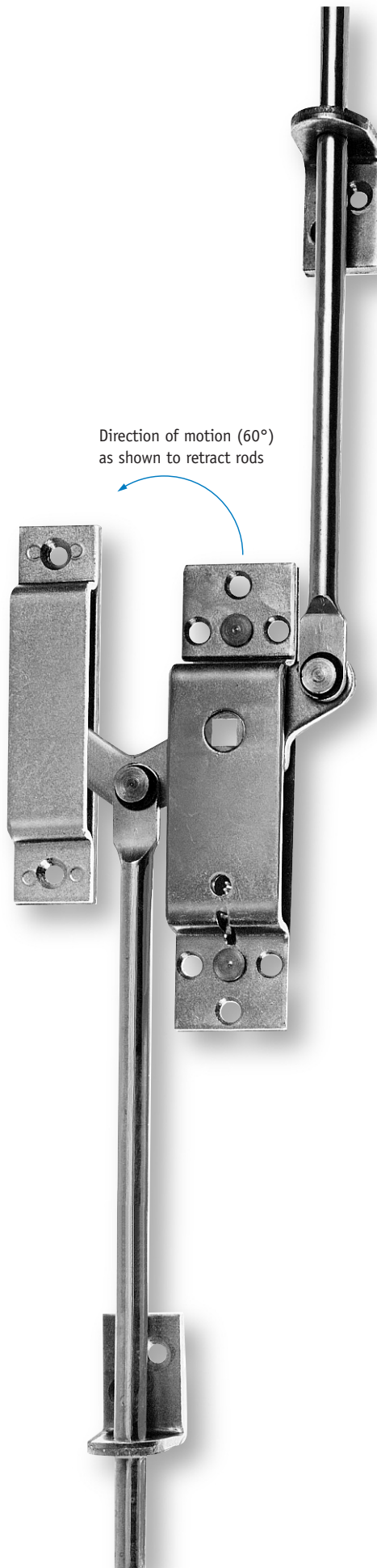

Left-hand rod latch 3/18254 (includes guides & keeper plate) shown fully extended, from inside.

633

3-WAY ROD LATCHES

A heavy-duty design which provides 3-point latching with an exceptional amount of 'throw'. This is a 'deadbolt' system with 10 mm diameter rods driven by centre bush, and held extended by action of a strong spring. Right-hand and left-hand models are available, with many options.



Close door, turn inside/outside handle (or T-key) to 'throw' rods and extend centre tongue. System cannot be slammed.



Centre bush rotates through 60° as shown to withdraw rods by 33mm (each end) and to pivot centre tongue to vertical. System is 'handed' by direction of rotation and position of tongue and rods.



Latches are fully plant-on. Rod ends should be cut as required : guides and keeper are supplied with full system.



Zinc-plated throughout.



- Special rod lengths to order
- Permanently-attached inside handle
- 'Male drive' (8 mm square) spindle on inside/outside of latch.

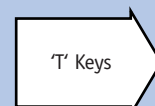

SIMPLIFIED ROD LATCHES

These models do not have mounting case or spring, and fit directly on to a fixed, 8 mm shaft. They represent a very simple, economical way of securing large compartments. Additional support can be gained by use of standard rod guide-plates.

9/01177 (shown)

Centre bar (5/00508) has 32 mm centres and 8 mm 'diamond' piercing. Rotation through 90° will withdraw rods by 15 mm, approx. Rod lengths 1090 mm. (Also available with 'square-on' piercing as 9/01178).

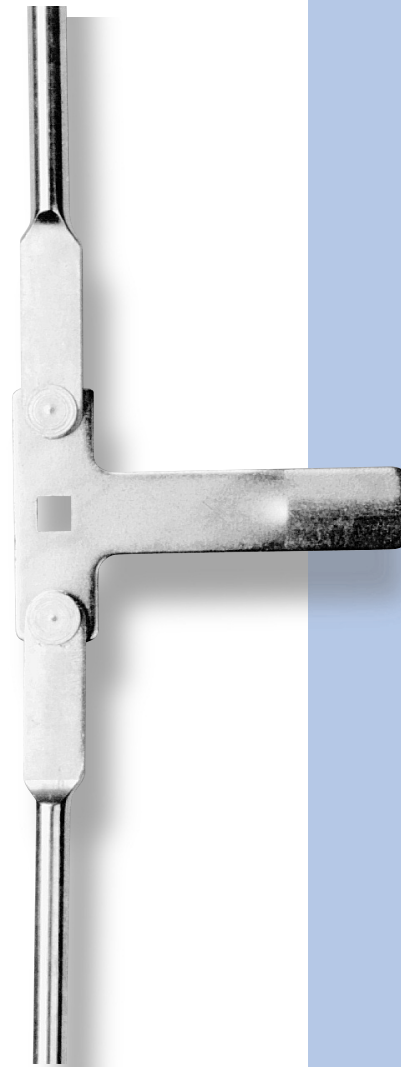
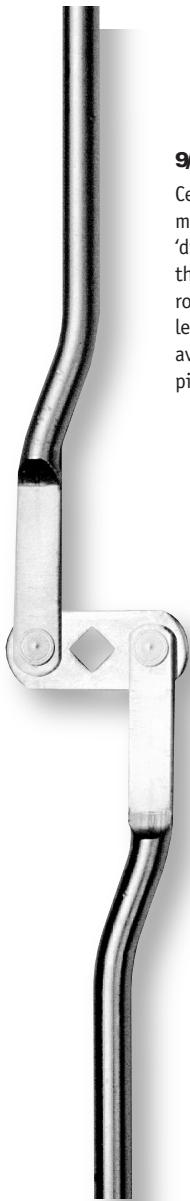

9/01779 (shown)

Centre bar (5/01993) has 50 mm centres and latching tongue with cam-form to 85 mm length. Rotation through 90° will withdraw rods by 25 mm, approx. Straight rods at 380 mm (each).

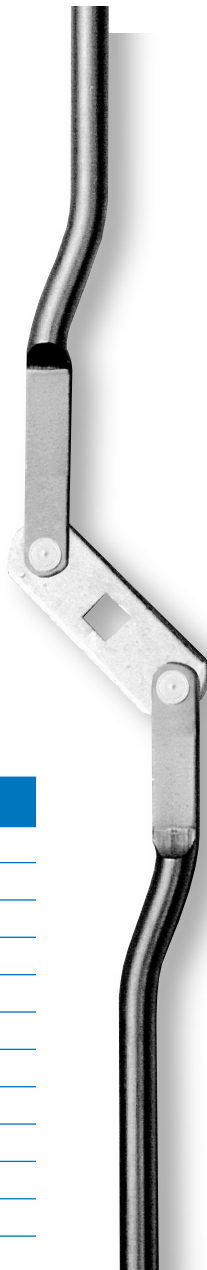

9/01078 (shown)

Centre bar (5/00789) has 46 mm centres and 8 mm 'square-on' piercing. Rotation through 90° will withdraw rods by 23 mm, approx. Rod lengths 1090 mm. (Also available with 'diamond' piercing as 9/01077).



Rods are completely free to move on handle shaft, to a maximum of 160° travel.



Centre bar must be secured to handle, often using locknuts on M10 threaded shaft. Rod guides at each end will provide additional support.



Zinc-plated throughout.



Centre bars in 3 mm-thick mild steel, riveted to 10 mm-diameter rods normally at 1090 mm length.



- Special rod lengths
- Rods can be 'opposed' (opposite to illustrations)
- Tapered ends.

ORDERING CODE

2-way latch at 32 mm centres

9/01177 'diamond' piercing

9/01178 'square-on' piercing

2-way latch at 46 mm centres

9/01077 'diamond' piercing

9/01078 'square-on' piercing

3-way latch at 50 mm centres

9/01779 'square-on' piercing

3/18716 Rod guide



Guide plate 3/18716

Made in 4 mm material, base size 25x40 mm, with height to hole centre line of 14 mm

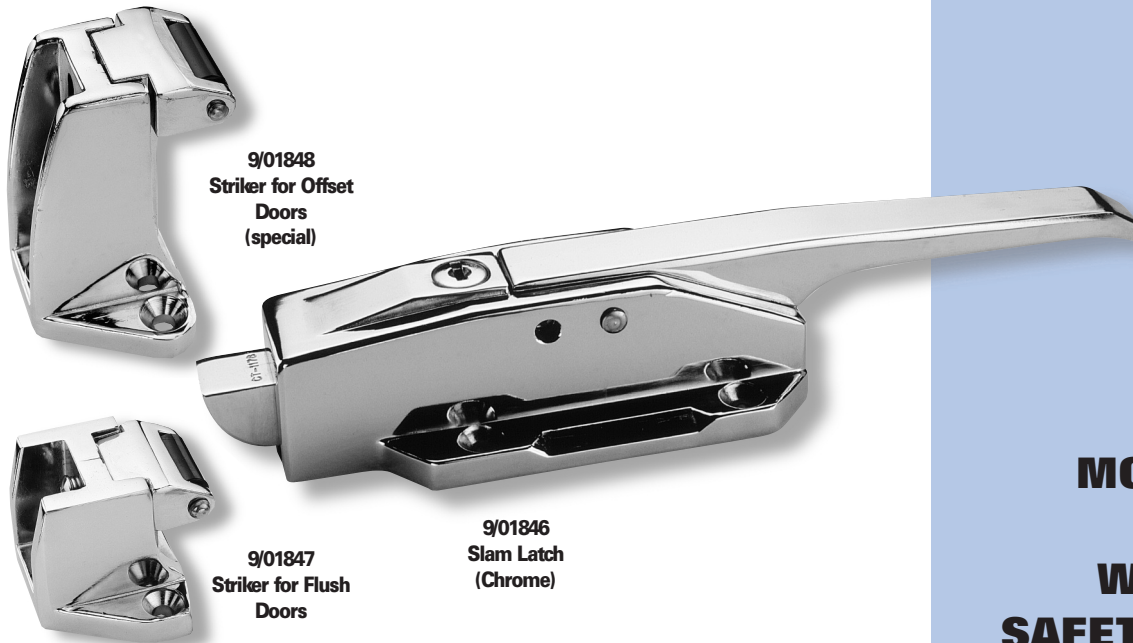

**SURFACE -
MOUNT SLAM
LATCH SET
WITH INSIDE
SAFETY RELEASE**

This latch is widely used for large-size insulated enclosures, such as cold stores or containerised units, where a surface-mounted latch is preferable to avoid breaching the integrity of the door.

With slam action against a roller striker, this system can be used on doors flush-fit against the frame, or offset between 35-70mm height. There is an inside safety "punch" handle for emergency release.

! Smooth slam action and inside release with fluorescent 'mushroom' head for good visibility and fast operation. Offset striker adjustable in 2.5mm increments.

↕ Locking with key blocks movement of handle, but bolt can still be slammed shut and opened from inside.

⌘ Surface-mounted latch and striker through 6 mm countersunk holes in flanges.

🔑 Non-standard, single-sided keys. Can also be locked with padlock or cotter pin through body of latch.

🔧 Bright chromium plated or black electrophoretically painted for exterior use.

M Diecast in zinc alloy with inside release moulded in glass-filled material with rubber sleeve and stainless mounting plate.

£ Highly competitive against market alternatives.

ORDERING CODE

9/01843 Latch set (comprising 9/01846, 9/01847, 9/01849)

9/01843B As above, black

9/01848 offset striker (special order only)

SPECIFICATION

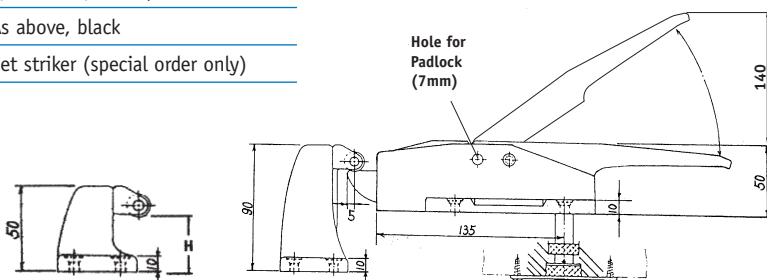

(Standard distance for fixing)

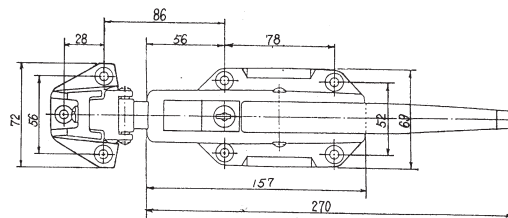

All mounting holes in latch & striker are 6 mm diameter in 10 mm deep flanges

Inside release handle

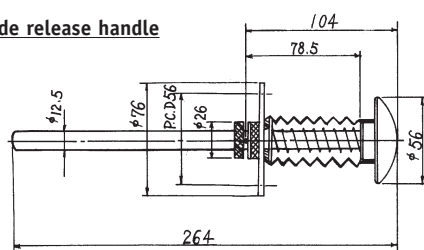

Fixing through 3x5 mm holes in stainless steel flange plate

Striker height (H) to roller

9/01847 30 mm, fixed

9/01848 65-100 mm adjustable

Adjust striker block by set-screws against base plate in 2.5mm increments.



9/01849
Inside release handle with fluorescent 'mushroom'

LATCHES

**LATCHES,
CATCHES,
& DOOR
HOLDBACKS**

**NEW
PRODUCT**



New, circular door hold-back can be used with all-glass doors

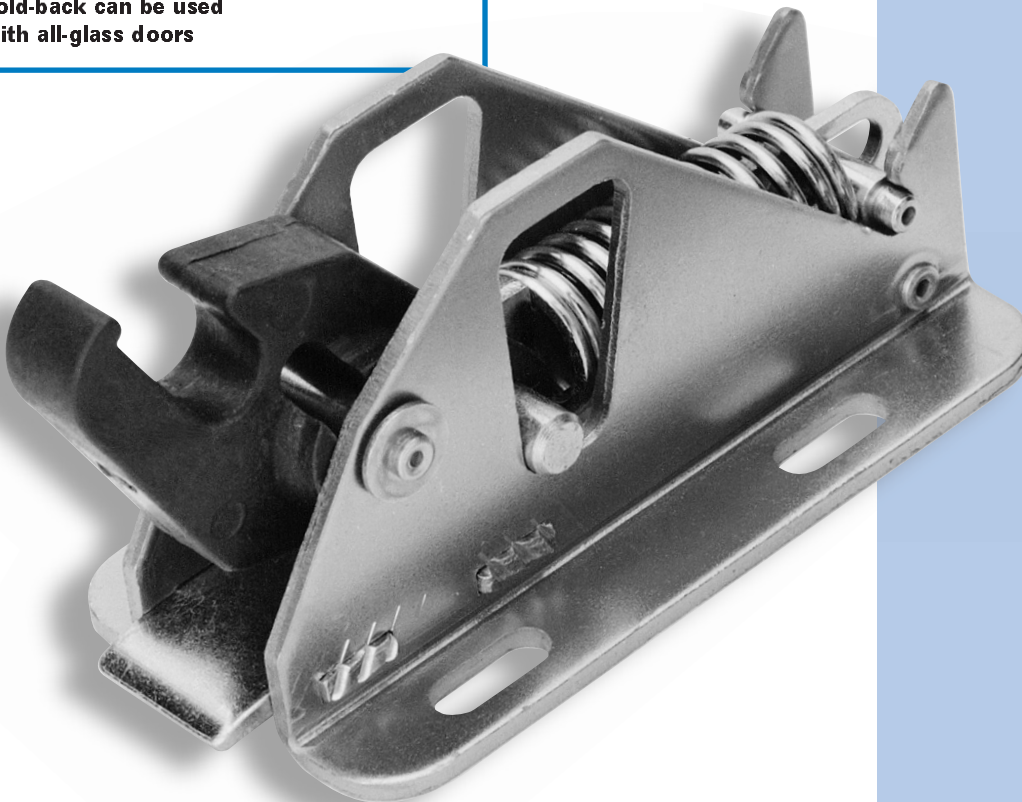

Above: Engine cover 'hold-down' latch suits buses, grilles and large industrial enclosures

The WBH range extends from simple 'budget' and 'slam' latches to advanced, anti-burst models for on-road vehicles.

Additionally, this section includes new types of door hold-back units and over-centre catches, with innovative designs in stainless steel and in moulded materials.

Where appropriate, anti-burst latches supplied to major automotive manufacturers are tested to meet SAE & ECE 11 specifications.

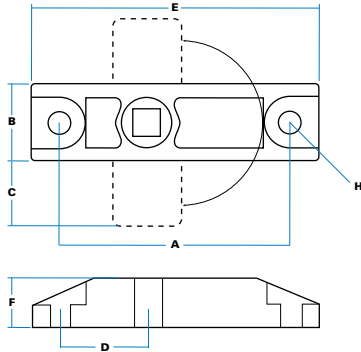
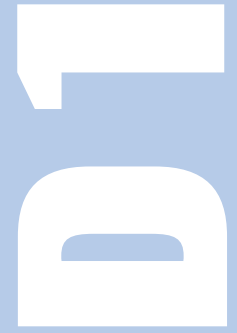

9/01956 (set)
Budget latch & catch
plate, complete.



9/01957
(with shaft)

ORDERING CODE

- 9/01956 Moulded budget latch & striker
9/01957 As above, c/w shaft & pin

SPECIFICATION

A	Hole Centres	66 mm
B	Case Width	22 mm
C	Bolt Projection	19 mm
D	Location	33 mm
E	Case Length	83 mm
F	Thickness	14 mm
H	Hole Size (diameter)	Ø 7 mm
J	Shaft (when supplied)	10 mm



9/01960

ORDERING CODE

- 9/01960 Moulded escutcheon cover

SPECIFICATION

A	Length	40 mm
B	Height (Max.)	8 mm
C	Width	30 mm
D	Diameter	16 mm
E	Hole Centres	20 mm
F	Hole Centres	18 mm
H	Hole Sizes, (diameter)	4 mm c/s 6 mm

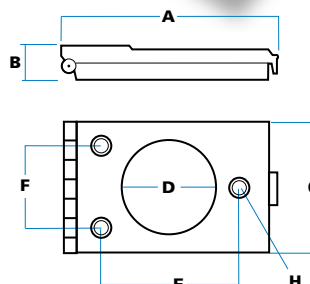

MOULDED 'BUDGET' LATCH

An ingenious design that replicates the function of our 'Universal' budget latch, but which takes full advantage of the properties of moulded materials. It is tough, lightweight, non-magnetic, self-lubricating, and totally corrosion-resistant.

A special version is supplied with 8mm steel shaft, which can be fitted to either face (9/01957). This is normally used with moulded handle, 5/01664.

- Simple 'deadbolt' latch, operated by 8mm square or by slot in top & bottom faces, against ramped striker.
- Non-handed design, with bolt able to travel 180° through case but held positively in open and closed positions by concealed spring.
- Bolts or rivets through fixing holes in recessed areas. Use large-headed fasteners (to 12mm dia.) for security.
- Self-colour black with attractive textured finish.
- M** Moulded throughout in acetal copolymer for maximum strength/wear resistance.
- T** Progressive load tests were carried out by an independent proof house, and as a comparison on steel model (3/09656).

Moulded latches operated without distortion until loading of 0.63KN (70Kg). Steel latches became progressively distorted and failed at around 1.5KN (165Kg).

Note These latches are not recommended for applications involving impact loading.

MOULDED ESCUTCHEON COVER

Simple 'snap-shut' covers to protect external panel aperture. Waterproof, opens to 150° for easy fitting (no spring return).

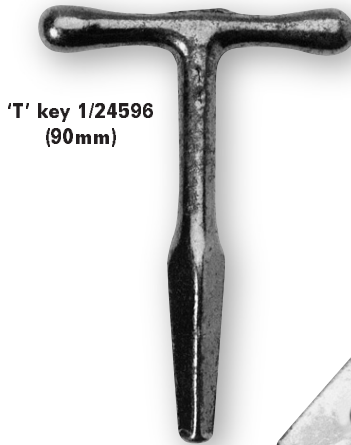

'T' key 1/24596
(90mm)

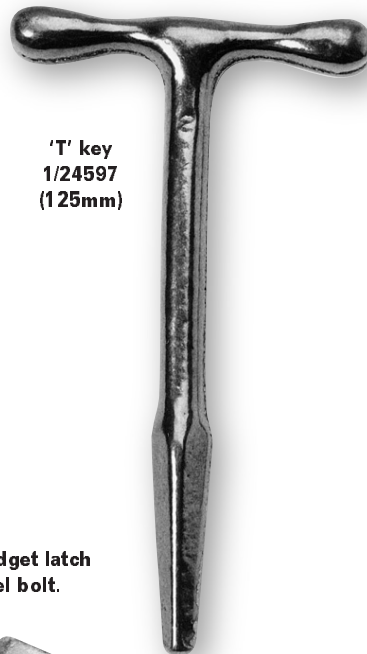

'T' key
1/24597
(125mm)

3/09656 Budget latch
with steel bolt.

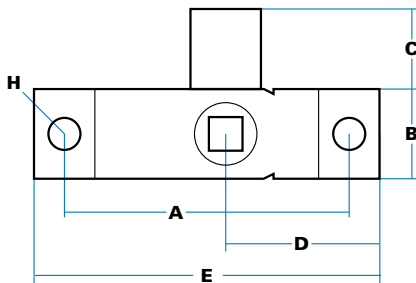
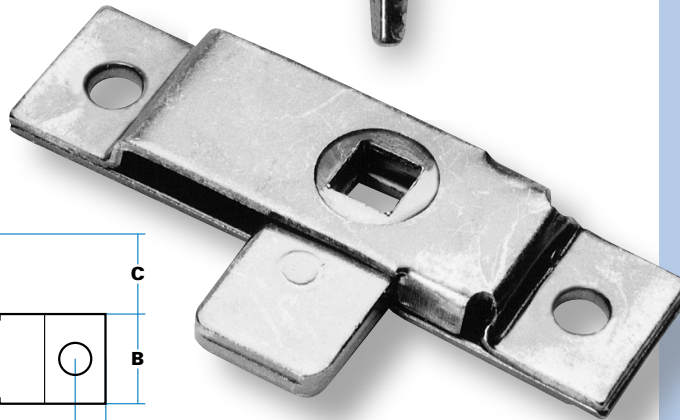

ORDERING CODE





1/24596	'T' Key 90 mm length
1/24597	'T' Key 125 mm length
3/09656	Universal budget latch - steel
3/09282	Universal budget latch - moulded bolt
3/09656SS	Universal budget latch - stainless steel

SPECIFICATION

A	Hole Centres	66 mm
B	Case Width	22 mm
C	Bolt Protection	18 mm
D	Location	38 mm
E	Case Length	85 mm
F	Thickness	10 mm
H	Hole Size Diameter	7 mm

**'UNIVERSAL'
BUDGET LATCH
& FITTINGS**

This simple 'deadbolt' latch has become an industry standard. Basic model is mild steel construction, with options in stainless steel or with moulded bolt. Two sizes of operating keys are available and diecast escutcheon covers can be fitted to conceal panel aperture.

-  Simple 'deadbolt' latch operated by 8mm square follow-bush.
-  Non-handed design, with bolt able to travel 180° through case, but held positively in open and closed positions by concealed spring.
-  Bolts or rivets through fixing holes through top & bottom plates.
-  Zinc plated throughout, with mild steel models.
-  Moulded nylon bolt (black) as option with mild steel model. All-stainless latch for corrosion resistance (food industry, etc.).

T-Keys are in malleable iron, burnished & lacquered, and suit all 8mm square follow-bushes.

7/27900
2-hole cover

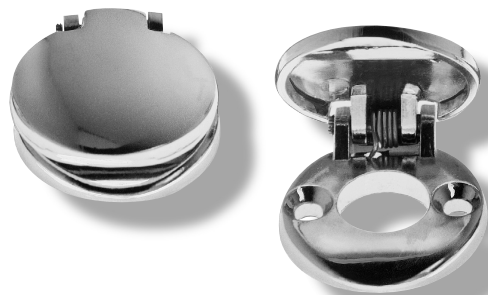

ORDERING CODE

7/27900	Escutcheon Cover, 2-hole, chrome
----------------	----------------------------------

SPECIFICATION

A	Length	32 mm
B	Height (max.)	8 mm
C	Width	28 mm
D	Diameter	13 mm
E	Hole Centres	20 mm
F	Hole Centres	15 mm
H	Hole Sizes, c/s 5mm	3 mm

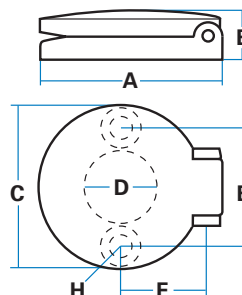

**DIECAST 2-HOLE
ESCUTCHEON
COVER**

Simple 'snap-shut' covers to protect external panel aperture. Waterproof, with spring return, opens to 110° for easy fitting.

3/10510 (LH)



3/10511 (RH)

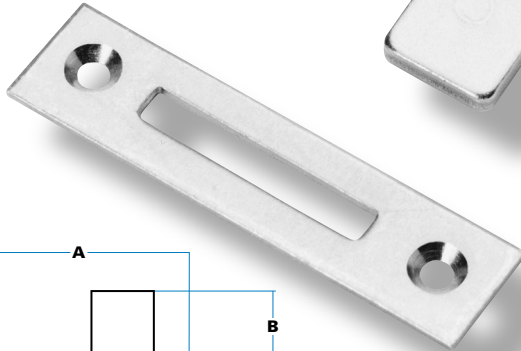

9/00749 striker plate
(60mm hole centres)

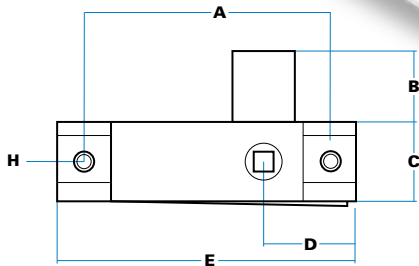

ORDERING CODE

3/10510	Budget latch, LH
3/10511	Budget latch, RH
3/10510/01	Budget latch, LH, 5mm holes
3/10511/01	Budget latch, RH, 5mm holes
9/00749	Striker plate

SPECIFICATION

A Hole Centres	66 mm
B Bolt Height	18 mm
C Case Width	22 mm
D Location	28 mm
E Case Length	83 mm
F Thickness	10 mm
H Hole Sizes, (diameter)	6 mm c/s 10 mm

9/00160
3-hole cover



ORDERING CODE

9/00160	Diecast Escutcheon Cover
----------------	--------------------------



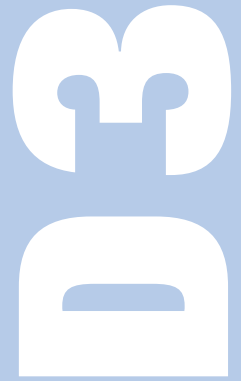
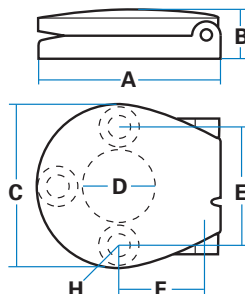

SPECIFICATION

A Length	28 mm
B Height (max.)	8 mm
C Width	28 mm
D Diameter	13 mm
E Hole Centres	20 mm
F Hole Centres	12 mm
H Hole Sizes, (diameter)	3 mm c/s 5 mm



**'HANDED'
BUDGET LATCHES**

Cleverly designed so that top and bottom plates are mechanically interleaved for maximum strength, these latches have an exterior spring and are 'handed' as shown. Fixing holes on standard models are countersunk after plating but versions are available with plain 5mm holes.

-  Simple 'deadbolt' latch operated by 8mm square follow-bush.
-  Bolt travels 90° only, LH or RH as shown, and is positively held in both 'open' and 'shut' position by fitted spring.
-  Bolts or rivets through fixing holes.
-  Latches and striker plate are zinc-plated throughout.

**DIECAST 3-HOLE
ESCUTCHEON
COVER**

Simple 'snap-shut' covers to protect external panel aperture. Waterproof, with spring return, opens to 110° for easy fitting.

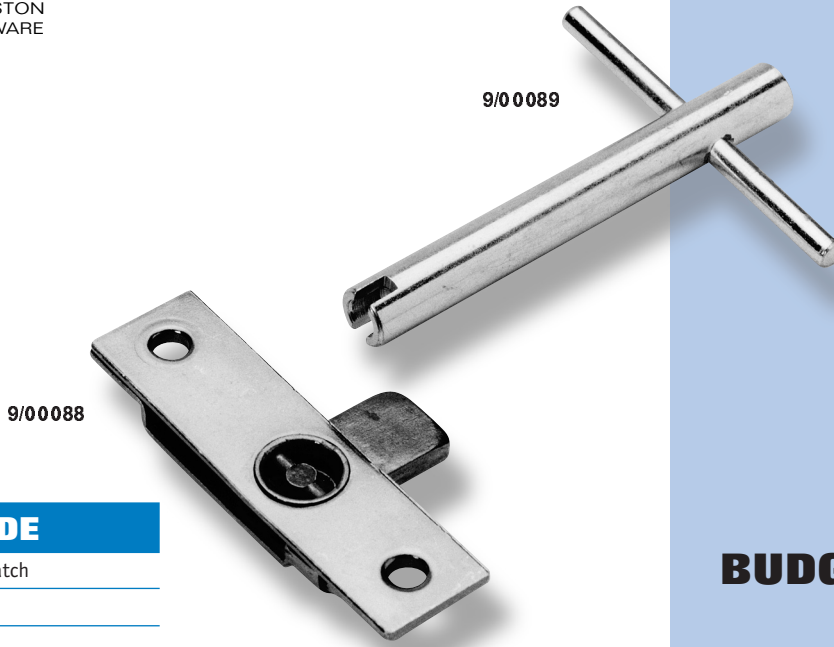

SECURITY BUDGET LATCHES

With same dimensions as the 'Universal' model, this design has a forged brass bolt to provide a blind, dust-proof centre which requires a special security key to operate. Latch is zinc plated.

ORDERING CODE	
9/00088	Security budget latch
9/00089	Security key
9/00749	Striker plate

ORDERING CODE	
3/09817	'Mortice' budget latch
9/00749	Striker plate

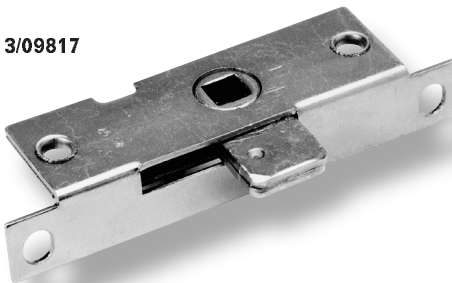

'MORTICE' BUDGET LATCH

This is a very useful model when used with wooden or board panels, since the latch can be morticed into the door edge, and the flange gives a clean, hard-wearing edge. Zinc plated, 'handed' (LH) as shown.

SPECIFICATION		
A	Hole Centres	76mm
B	Bolt Height	15mm
C	Case Width	26mm
D	Flange Height	17mm
E	Case Length	83mm
F	Location	36mm
G	Hole Centres	94mm
H	Hole Sizes (Diameter)	Ø 7mm
J	Hole Sizes	6 x 8mm

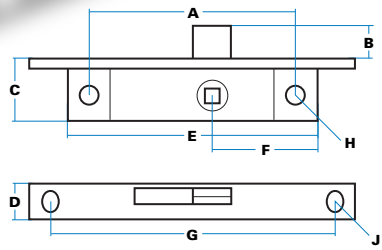

ORDERING CODE	
3/10843	'Bridge' latch, LH
3/10844	'Bridge' latch, RH

SPECIFICATION		
A	Hole Centres	76mm
B	Bolt Height	20mm
C	Case Width	22mm
D	Location	31mm
E	Case Length	90mm
F	Max. Height	21mm
G	Bolt Min. Height	22mm
H	Hole Sizes (Diameter)	Ø 5.5mm

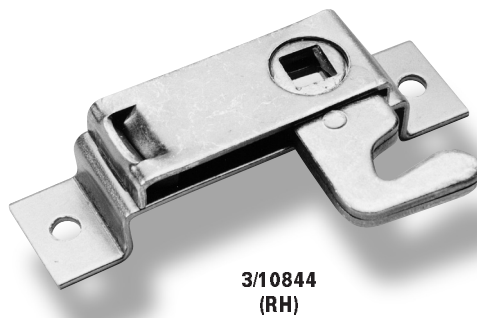

'BRIDGE' BUDGET LATCH

Mounted on a 'bridge' plate, this model gives extra clearance from the fixing surface. The hook gives a positive 'hold-down' against a stud or pin. Note that the hooked bolt does not completely withdraw into the case. Zinc plated, 'handed' as shown.

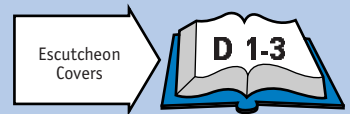
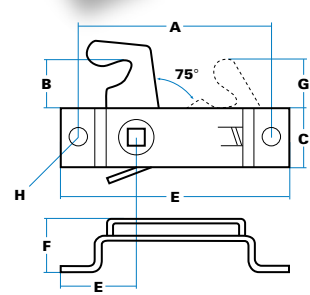

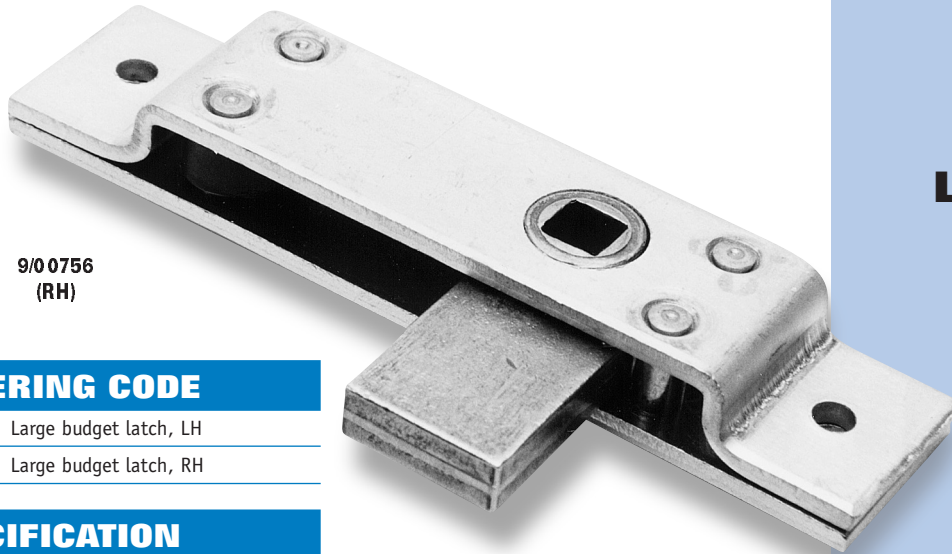
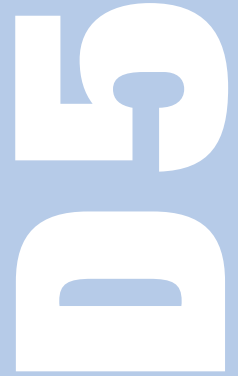

9/00756
(RH)

ORDERING CODE

9/00755 Large budget latch, LH

9/00756 Large budget latch, RH

SPECIFICATION

A Hole Centres	108 mm
B Bolt Height	25 mm
C Case Width	28 mm
D Location	48 mm
E Case Length	127 mm
F Case Depth	15 mm
G Location	22 mm
H Hole Sizes (Diameter)	∅ 5 mm

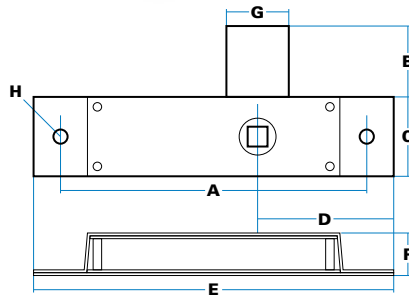

LARGE BUDGET LATCHES

With exceptionally strong construction, this model suits heavy applications and where a stronger, more substantial bolt is required to resist abuse. Uses include large storage containers, bus engine and luggage compartments.



Very substantially constructed with 3mm steel plates for full length of latch, four steel pillar rivets to prevent 'bowing' and distortion, and forged 8 mm brass bolt.



'Handed' for 90° operation, LH/RH as shown operated by standard 8mm square follow bush.



Fixing through 5mm holes. These can be enlarged or countersunk to special order.



Zinc-plated, with chemically-blackened spring.

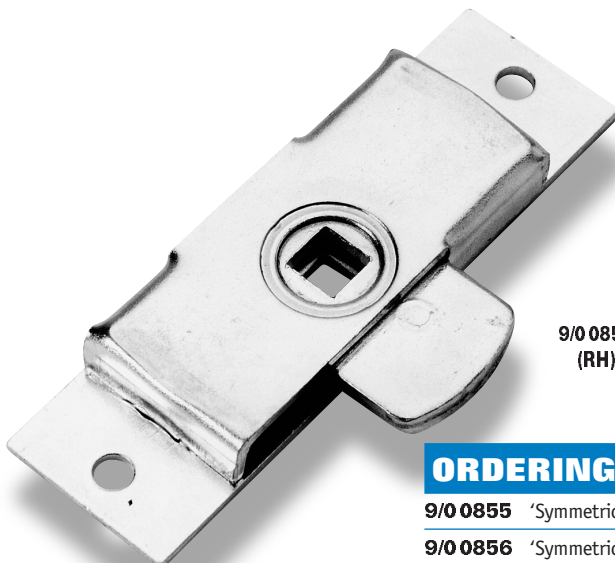

9/00856
(RH)

ORDERING CODE

9/00855 'Symmetrical' budget latch, LH

9/00856 'Symmetrical' budget latch, RH

SPECIFICATION

A Hole Centres	86 mm
B Bolt Height	15 mm
C Case Width	28 mm
D Location	51 mm
E Length	98 mm
H Hole Sizes (Diameter)	∅ 5 mm

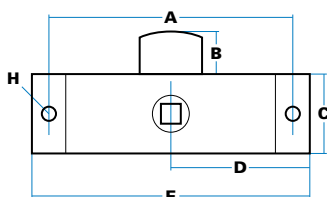

'SYMMETRICAL' BUDGET LATCHES

All-steel latches, with bolt centred in case for symmetrical operation. Movement 90°, LH or RH, with bolt held positively by a concealed spring. Finish is clear zinc plated.



Fixing through 5mm holes. These can be enlarged or countersunk to special order.



Zinc-plated throughout.

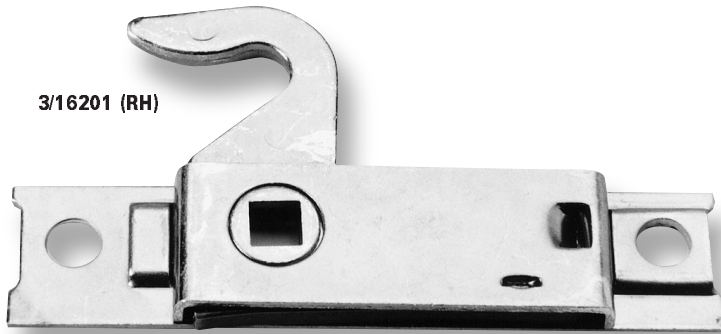
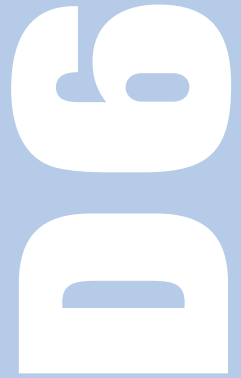

3/16201 (RH)

HOOKED BUDGET LATCHES

These models have a shaped 'hooked' bolt which engages with a pin to hold two panels together laterally. The shape of the hook and string spring provide very positive engagement.



'Handed' for 90° operation, LH/RH as shown, with deadbolt held positively in both 'open' and 'shut' positions by fitted spring. Note that tip of bolt will project from case when bolt is withdrawn.



Plant-on fixing through 9mm holes. Note that top and bottom plates are mechanically interleaved for maximum strength.



Normal finish is zinc plated.

SPECIFICATION

A Hole Centres	93 mm
B Engagement	24 mm
C Case Width	25 mm
D Location	42 mm
E Case Length	112 mm
F Max. Height	8 mm
G Min. Projection	13 mm
H Hole Sizes	9 mm

Original application: as boot latches, LH on MG Midget, RH on TR4/5.

Right-hand illustrated

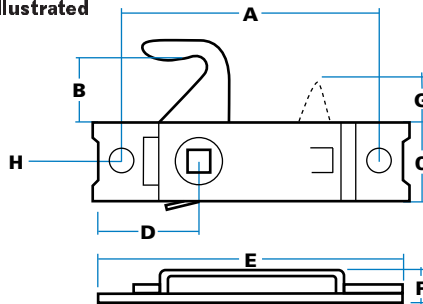

ORDERING CODE

3/16200 Hooked budget latch, LH

3/16201 Hooked budget latch, RH

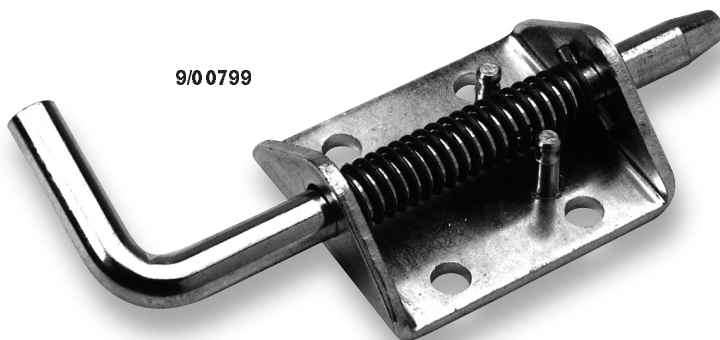

9/00799

ORDERING CODE

9/00799 Spring bolt

SPECIFICATION

A Case Length	60 mm
B Case Width	50 mm
C Height	15 mm
D Engagement	25 mm
E Projection	10 mm
F Projection	65 mm
G Hole Centres	30 mm
H Hole Sizes (Diameter)	7 mm

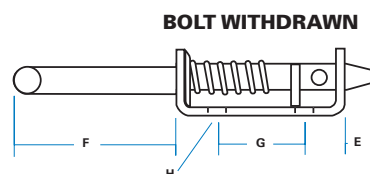
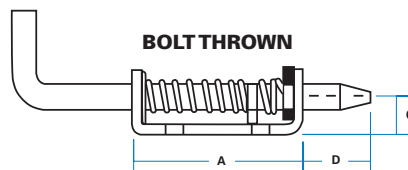

SPRING BOLT (LOCKABLE)

A simple, plate mounted spring bolt, using 10mm diameter steel rod with turned end for easy engagement. When withdrawn the bolt can be turned to lock behind two pillar rivets as shown. Bright zinc-plated finish.

MOULDED SLAM LATCHES

The unique design of these latches allows 'fix through' mounting to suit narrow door pillars, sections and channels. Moulded construction provides the benefits of lightweight, self-lubricating action, and total corrosion resistance at an inexpensive price.



Basic Latch (9/01530) is operated by rod or cable as part of a slam system. Single-point models use a large knurled knob for good grip.



Slam bolt retracts fully into case when operated. Slotted bolt-pull provides 'lost-motion' so latches can always be slammed, even when a system is in 'locked' mode.



Fixing by rivets through 6mm holes in case. Use large-headed fasteners to spread load over area.



Latches are self-coloured black with attractive textured finish.



Moulded in acetal copolymer, with stainless steel spring.



Tooling allows special bolt nose shapes to be made, subject to economical minimum batches.



Cycle Testing: The slam latch 9/01530 was tested to over 50,000 cycles of slam and withdrawal with no appreciable wear to bolt-nose or bolt-pull.



Highly competitive against market alternatives.

ORDERING CODE

- 9/01528** Moulded slam latch, reversed knob
9/01529 Moulded slam latch, pull-knob fitment
9/01530 Moulded slam latch

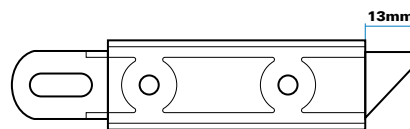

Special model with side-action bolt, suitable for roller shutters, etc.

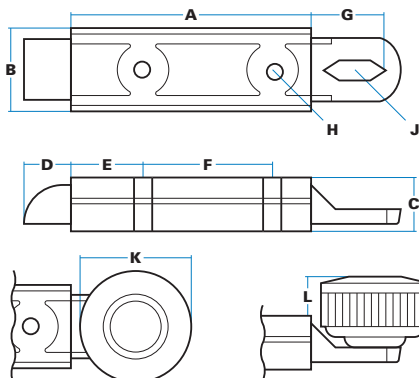

SPECIFICATION

A Body Length	80 mm
B Body Width	29 mm
C Body Height	18 mm
D Bolt Projection	16 mm
E Location	23 mm
F Location	44 mm
G Location	25 mm
H Hole Diameter	Ø 6 mm
J Slot Dimension	7x20 mm
K Knob Diameter	Ø 38 mm
L Knob Height (max)	16 mm

Spring pressure: 6kg to full bolt withdrawal

Note: Knob & rivet can be supplied loose, for assembly after latch is installed in panel.

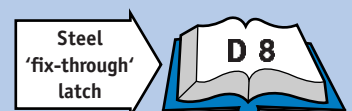

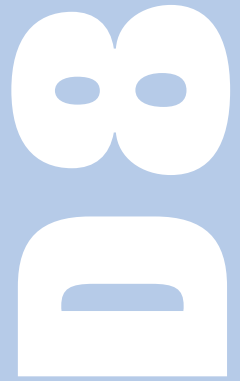

9/01186

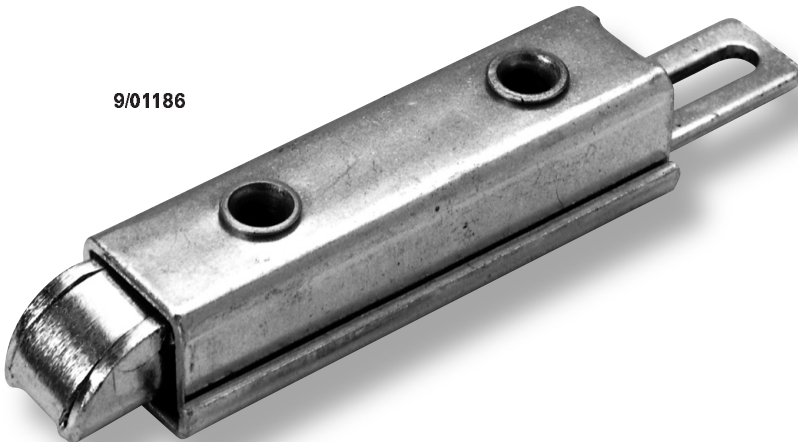

ORDERING CODE

9/01186 'Fix-through' slam latch steel

SPECIFICATION

A Body Length	80 mm
B Max. Width	25 mm
C Max. Height	20 mm
D Projection	13 mm
E Location	20 mm
F Location	43 mm
G Location	23 mm
H Hole diameter	7 mm
J Slot dimensions	6x20 mm
K Knob diameter	Ø38 mm
L Knob height (max)	20 mm

Spring pressure: 5kg to full bolt withdrawal

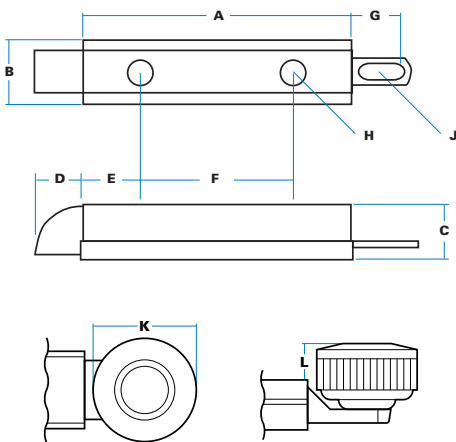

**'FIX-THROUGH'
SLAM LATCH
IN STEEL**

Special design allows 'fix-through' mounting, to suit narrow door pillars, sections and channels. This is interchangeable with our moulded model (9/01530) but may be preferred where there is possibility of impact loads or lateral stress.



Slam bolt retracts fully into case when operated. Slotted bolt-pull provides 'lost-motion' so latches can always be slammed, even when a system is in 'locked' mode.



Fixing by rivets through 7mm holes in case. Use large-headed fasteners to spread load over area.



Bright zinc-plated

9/01728
'nose-up'

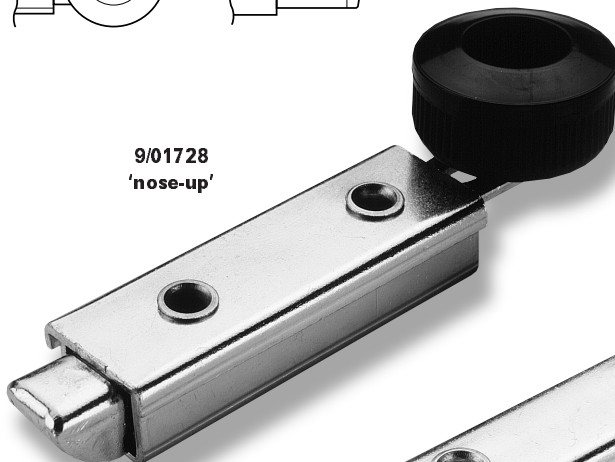

9/01729
'nose-down'



ORDERING CODE

9/01728 Latch & knob, nose-up

9/01729 Latch & knob, down

**SINGLE POINT
SLAM LATCHES**

The basic steel latch can be fitted with a large, knurled moulded knob, riveted in position in either 'nose-up' or 'nose-down' styles.

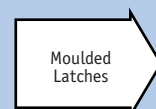



END-SLAM LATCHES (END BOLTS)

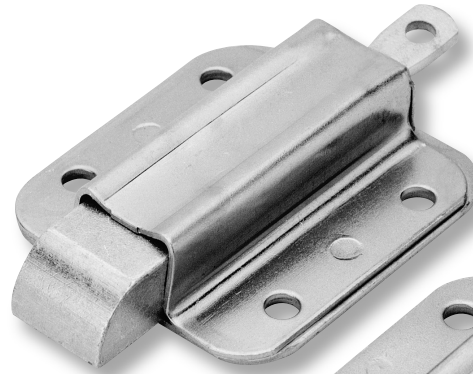

3/22387 with plain bolt-pull

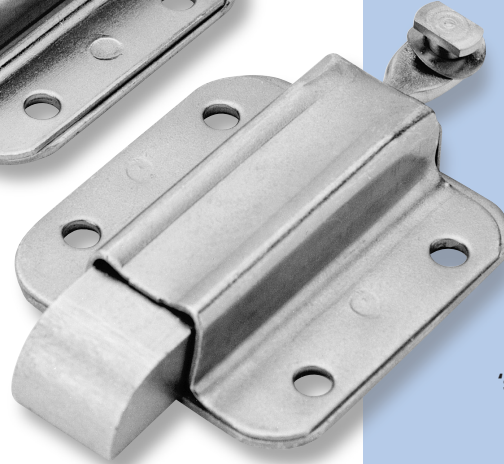

3/22386 with 'quick-fit' attachment point

3/22388 'Nose-up' bolt allows use on inward-opening doors



Precision-made latches which have become motor-industry 'standards', with solid, machine-cut steel bolts and 'quick-fit' attachment point if desired. Adjustable bolt-pull allows bolt projection to be varied, and bolts are reversible to 'nose-up' position. Stainless steel models available.

ORDERING CODE





3/22386	End latch, nose-down, 'quick-fit' pull
3/22387	End latch, nose-down, plain pull
3/22388	End latch, nose-up, plain pull
3/22389	End latch, nose-up, 'quick-fit' pull
3/22392	End latch, special (non-reversible)
9/01187	Stainless steel latch (as 3/22387)
3/22384	Packing plate

SPECIFICATION

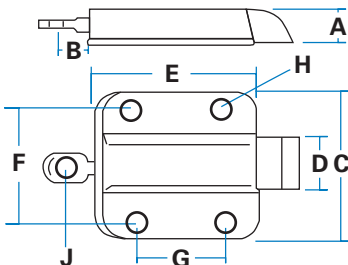
A	Bolt Thickness	13 mm
B	Bolt Pull	13 mm
C	Width	57 mm
D	Bolt Width	19 mm
E	Body Length	62 mm
F	Hole Centres	44.5 mm
G	Hole Centres	33 mm
H	Hole Diameter	Ø 5.5 mm
J	Hole Diameter	Ø 5 mm

Bolt projection variable, 9-16 mm.
Minimum load 5kg for full bolt travel.
Mild steel model made in CR4.
Stainless models in grade 304 with stainless bolt-pull, bolt and spring.



-  Spring-loaded slam latches, normally used as part of a 2-way or 3-way system.
-  Bolt retracts fully into case either by slam-action or by withdrawing bolt-pull.
-  Four holes, 5.5mm dia, through both thicknesses of material. A packing plate is available (3/22384).
-  Zinc-plated finish on mild steel models. Stainless steel models supplied in mill-finish, can be polished as an option.
- T** Bolt spring pressure is 6kg (14lbs)
- ?** Bolt length can be varied and bolt-nose cut to special profiles. Model 3/22392 has off-centre pull and special non-reversible bolt.

Detail of 'quick-fit' attachment.
The cropped rivet allows fast attachment of link bar as shown. A wave washer prevents rattle and excessive 'play'.

Suggested link bar 3/1 2497, length 915mm.
Linkage bar is pierced to accept rivet and allow 22mm free movement.

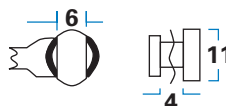



9/01455 (LH) with plain bolt-pull.
Bolt adjusted to 17mm,
minimum projection



**9/01458 (RH) with 'quick-fit'
attachment point. Bolt
adjusted to 25mm, max
projection**

**SIDE-ACTION
SLAM LATCHES
(FOR ROLLER SHUTTERS)**

Standard end latches with side-cut machined steel bolts at 45° angle, making them suitable for roller shutters or drop-down hatches. Adjustable bolt-pull allows projection to be varied, with 'quick-fit' attachment point for use with 2-way mechanisms.

ORDERING CODE

9/01455	Side-action latch LH
9/01456	Side-action latch RH
9/01457	Latch with 'quick-fit' pull,LH
9/01458	Latch with 'quick-fit' pull,RH
3/12497	Slotted bar, 915mm
3/22384	Packing plate

SPECIFICATION

A	Bolt Thickness	13 mm
B	Bolt Pull	13 mm
C	Width	57 mm
D	Bolt Width	19 mm
E	Body Length	62 mm
F	Hole Centres	44.5 mm
G	Hole Centres	33 mm
H	Hole Diameter	∅ 5.5 mm
J	Hole Diameter	∅ 5.0 mm

Bolt projection variable, 17-25 mm.
Minimum load 5kg for full bolt travel.
Mild steel model made in CR4.
Stainless models in grade 304 with stainless bolt-pull, bolt and spring.

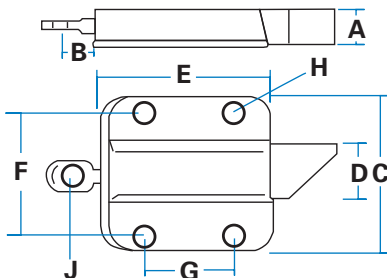

Mount on door moving vertically downwards, latch slams against a ramped striker plate.

Bolt retracts 13mm into case, either by slam-action or by withdrawing bolt-pull

Four holes, 5.5mm dia, through both thicknesses of material. A packing plate is available (3/22384).

Zinc-plated finish on mild steel models.

T Bolt spring pressure is 6kg (14lbs)

? - Bolts to special dimensions
- Top/bottom-knob models
- Stainless steel versions

Detail of 'quick-fit' attachment.
The cropped rivet allows fast attachment of link bar as shown. A wave washer prevents rattle and excessive 'play'.

Suggested link bar 3/12497, length 915 mm.
Linkage bar is pierced to accept rivet and allow 22 mm free movement.

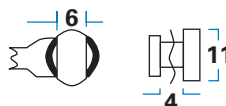

9/00279
'Nose-up'

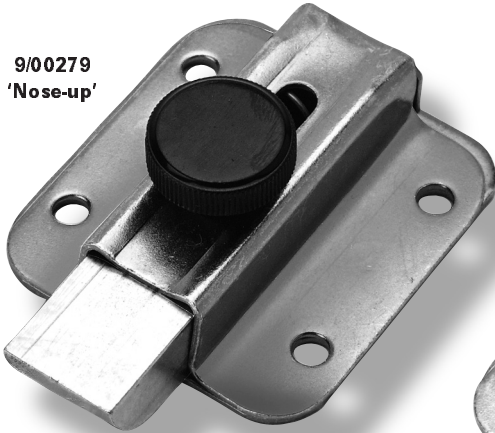

9/01059
Bottom knob
latch

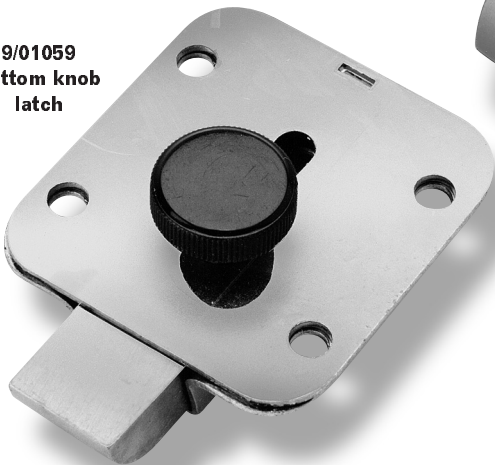

9/01243
'Nose-down'

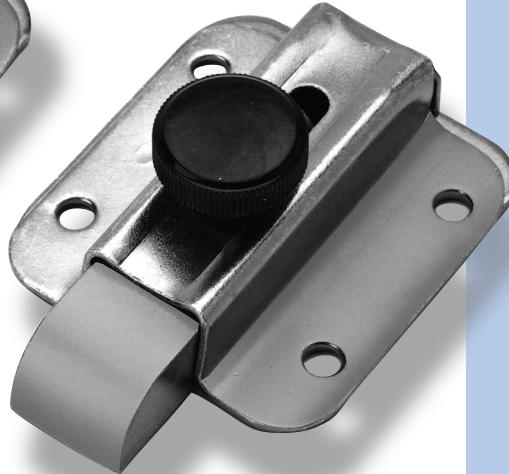

Stainless steel models are mill-finished but can be bright polished to special request.

ORDERING CODE

9/00279	Top-knob latch, nose-up mild steel
9/00279SS	Top-knob latch, nose-up stainless steel
9/01059	Bottom-knob latch, mild steel
9/01059SS	Bottom-knob latch, stainless steel
9/01243	Top-knob latch, nose-down mild steel
9/01243SS	Top-knob latch, nose-down stainless steel
9/00028	Pull-handle latch, mild steel

9/00028
Pull-Handle Latch
Fully adjustable
and fully reversible.



Height of loop 33 mm (max) above surface. Also available parallel to latch (height 13mm)

SINGLE POINT SLAM LATCHES

A range of compact slam latches derived from our standard end-bolts, but with direct action by knob or loop handle. These models are useful for seat squabs, gates and passive doors. They are also available in stainless steel.

Dimensions as 3/22386,
Bolt-spring pressure 2.5kg.

TOP-KNOB LATCHES



Surface-mounted design with 20mm diameter knob, at height 10mm above bolt case. Slam bolt projects 17mm and withdraws 15mm (non-adjustable and non-reversible).



Mild steel version is zinc-plated. Stainless steel version is mill finished.

BOTTOM-KNOB LATCHES



Useful for cowls or doors which need to be operated from outside. The knob can be removed, fitted through appropriate slot in the panel, and screwed back. Bolt is non-adjustable and non-reversible.

PULL HANDLE LATCHES



The standard end-latch with a 'loop' handle in 6mm diameter bar, raised at approx. 30° to horizontal.



Slam bolt is adjustable, with projection variable from 9mm - 16mm, withdrawing approx. 9mm. Bolt can be reversed to 'nose-up' position.



Mild steel version is zinc-plated.



9/0 0805
(LH)

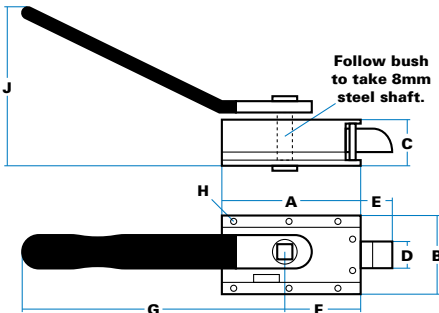

SPECIFICATION

A Case Length	70 mm
B Case Width	64 mm
C Case Height	20 mm
D Bolt Width	19 mm
E Bolt Projection	15 mm
F Location (bush)	32 mm
G Handle Length	165 mm
H Hole Sizes (dia)	5 mm
J Handle Height	90 mm
Depth Under Case	4 mm
Total bolt withdrawal	10 mm
Total Handle movement	45°
Min. load for full bolt retraction	10kg

ORDERING CODE

- 9/0 0805 Slam latch LH, with handle
- 9/0 0806 Slam latch RH, with handle
- 9/0 0851 Special latch (clockwise)
- 9/0 0852 Special latch (anti-clockwise)
- 9/0 0803 Slam latch, non-handed

Illustration to show 'handing'

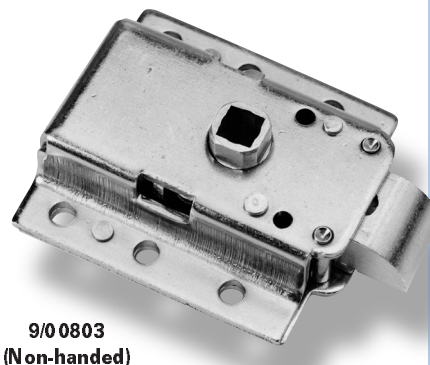
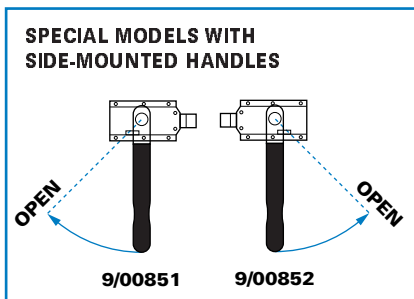
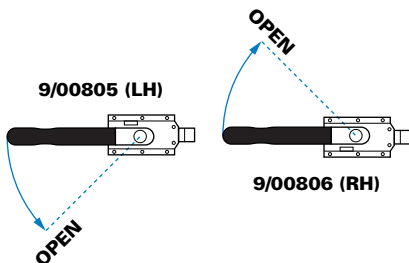

9/0 0803
(Non-handed)

**HEAVY-DUTY
SLAM LATCHES**

Exceptionally robust latches with fitted release handle for easy operation. There is a steel follow-bush so that when fitted on inside of a door, latch can be operated from outside by a standard 8mm square shaft. Suitable for heavy compartment doors and some types of off-road vehicle cabs.



Latch slams against door edge on ramped striker, is released by fitted handle or from reverse side through 8mm square follow bush.



Handle movement 45°, LH/RH as shown, with four options available.



Plant-on fixing by bolts or rivets through 5mm diameter holes on flanges. There is a bottom projection of 4mm on follow-bush for location purposes.



Zinc-plated, with black, nylon-dipped handle.



Bolt shape and projection variable, although total travel cannot be altered.



Use with any of our diecast locking handles with 8mm square shaft.

**NON-HANDED
SLAM LATCHES**

Essentially the same latch as above, but non-handed and without handle. Ideal for heavier doors where strong spring action is required.

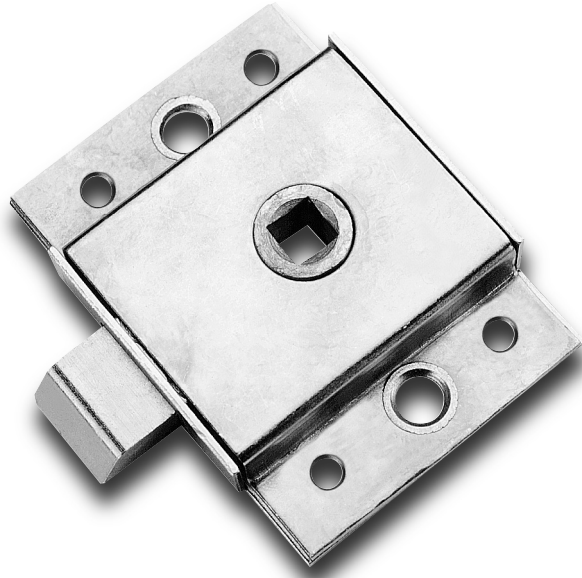

9/02732 with
6.5mm holes &
16mm bolt

ORDERING CODE

9/02730 'Utility' slam latch, 10mm bolt

9/02732 'Utility' slam latch, 16mm bolt

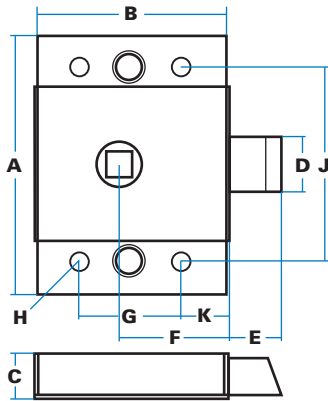

SPECIFICATION

A Case Length	80 mm
B Case width	60 mm
C Case Height	14 mm
D Bolt width	19 mm
E Bolt projection	10/16 mm
F Location (bush)	34 mm
G Hole centres	36 mm
H Hole sizes	dia 6.5 mm
J Hole centres	62 mm
K Location	14 mm
Bolt withdraws (maximum)	10mm
Bolt-spring pressure for full travel	5Kg

'Original' Models

Models below are identical but with mounting holes at 8mm diameter, countersunk to 10mm dia. (centre hole is an assembly feature only).

ORDERING CODE

3/17330 'Utility' slam latch, 10mm bolt

3/17332 'Utility' slam latch, 16mm bolt

9/01372 As 3/17330, bolt 'nose-up'

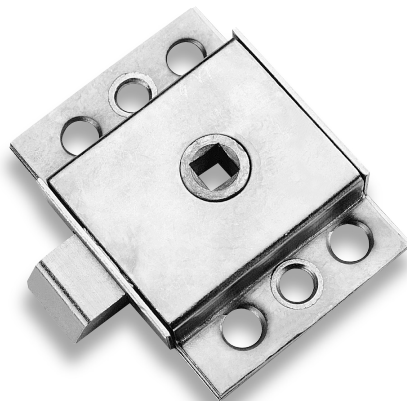

3/17332 with
8mm holes &
16mm bolt

310

'UTILITY' SLAM LATCHES

These well-proven latches have recently been re-designed to reduce size of mounting holes. The 'original' versions are still available when required.

Plant-on latches with central follow-bush which rotates 45° in either direction to withdraw bolt. Can be slammed even when handle is in 'locked' mode. Two lengths of bolt, zinc-plated finish.



Latch slams against striker plate; bolt is released by action of follow-bush.



Latches are non-'handed'. Rotate follow-bush in either direction to withdraw slam-bolt.



Fully plant-on fixings by bolts or rivets through three holes as shown.



Zinc-plated.



- Bolt fitted 'nose-up'
- Permanently retained inside spindle/handle
- Alternative fixing holes



'MINI' SLAM LATCHES

Originally developed for the 1961 'Mini' car, these latches are still the neatest and most compact models available. Normally used with our exterior locking handles, the latches can be slammed shut without damage, even when the handle (or safety catch) is in 'locked' position. Suitable for auxiliary compartment doors and off-road vehicles.



ORDERING CODE

- 3/22510** Latch, (RH), with safety catch
- 3/22511** Latch, (LH), with safety catch
- 3/22512** Latch, (RH), without safety catch
- 3/22513** Latch, (LH), without safety catch
- 1/27106** Striker plate

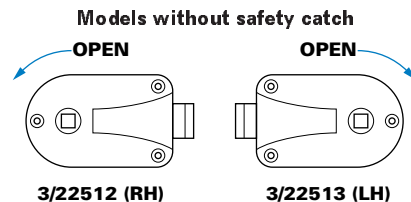
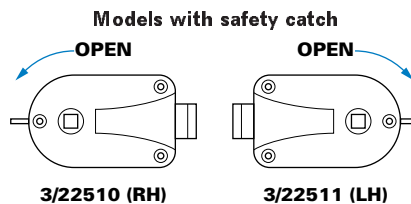
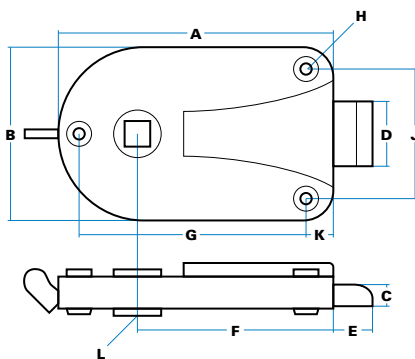

SPECIFICATION

A Case Length	95 mm
B Case Width	60 mm
C Case Height	16 mm
D Bolt Width	22 mm
E Bolt Projection	18 mm
F Location	66 mm
G Hole Centres	77 mm
H Hole Sizes	5 mm c/s 9 mm
J Holes Centres	43 mm
K Location	10 mm
L Projection	4 mm
Total bush movement	45°
Total bolt withdrawal	15 mm
Minimum load for full bolt retraction	6kg

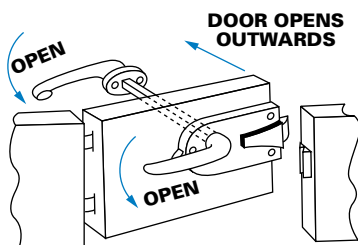

TYPICAL INSTALLATION - RIGHT-SIDE DOOR

Latch slams against striker plate; bolt is released by action of follow-bush.

Latches are 'handed' LH/RH by direction of rotation of bush, as shown. The safety catch (when fitted) prevents operation from outside, but allows latch to slam as normal.

Fully plant-on fixings by bolts or rivets through three 5 mm holes as shown.

Bright zinc-plated, with brass bolt and chromium plated safety catch.

Use with any of our outside handles, with 8 mm square shaft. Inside handle mounts directly onto through-shaft. Suggested striker plate is 1/27106



9/01283, RH latch,
shown in 'open'
position

9/00724 Striker,
normally used with
this latch

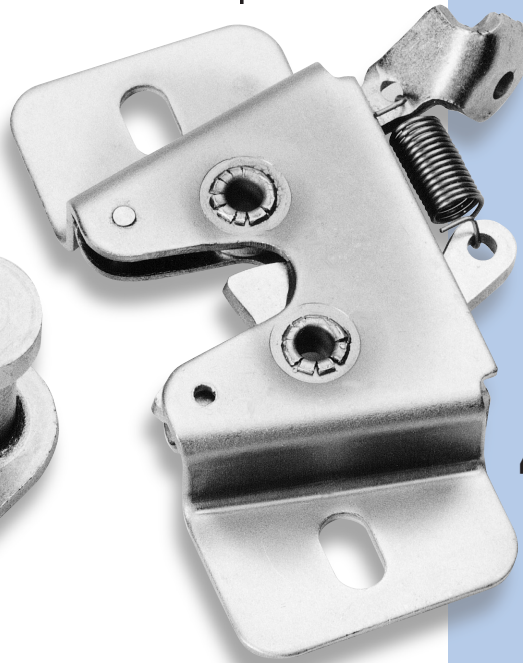
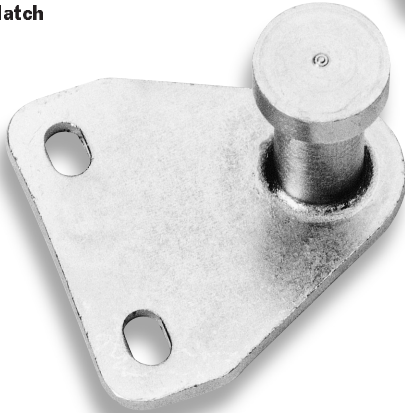

'CLAW' LATCHES SIDE-MOUNT

Extremely versatile units which sit within a compartment and slam against a striker peg to provide a very positive engagement. They release by pressure against top trigger or by remote cable. Used for top-opening hatches and covers where latch is concealed below edge of door or base unit.

LH 9/01583

Latches shown
with claw in
'engaged' position

RH 9/01283

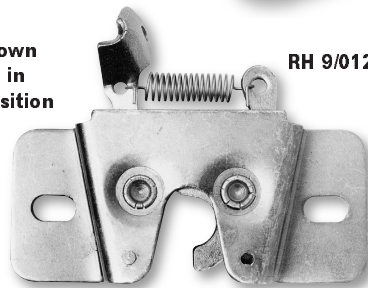
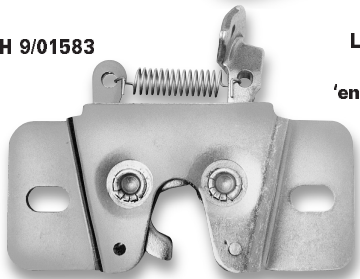

ORDERING CODE

9/01283 Claw latch RH, side-mount

9/01583 Claw latch LH, side-mount

9/00724 Pin-striker, 52 mm

9/01246 Pin-striker, 23 mm

SPECIFICATION

A	Length	100 mm
B	Height	50 mm
C	Width	19 mm
D	Location	21 mm
E	Hole Centres	76 mm
F	Location	30 mm
G	Hole Size (diameter)	3 mm
H	Hole Sizes	6.5 x 12 mm
Maximum force on trigger to release: 2.5kg		

J	Width	51 mm
K	Height	35 mm
L	Length	51 mm
M	Location	32 mm
N	Hole Centres	32 mm
O	Hole Sizes	5.5 x 9 mm
P	Pin diameter	12.5 mm
Q	Thickness	3 mm

An alternative striker, 9/01246, has K=23mm. Striker pins are staked and brazed, hardened and plated.



Slam-action against pin or loop striker plate. Both 'hands' available as illustrated.



Claw engages with striker and is released by pressure on top trigger or can be operated remotely via cable to hole in trigger plate.



Plant-on fixing through elongated holes in side flanges.



Zinc-plated latch and strikers.



Use with camlocks or handle with appropriate latch bar. 'Turnbutton' lock 9/01875 can release either directly or by remote cable.



Anti-burst properties
When rig-tested these latches can achieve values in excess of 6.0KN transverse load (direct pull). However they must not be used for passenger restraint doors.

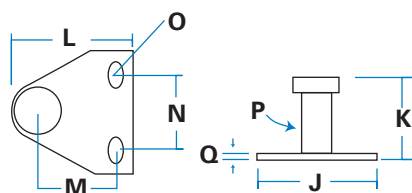
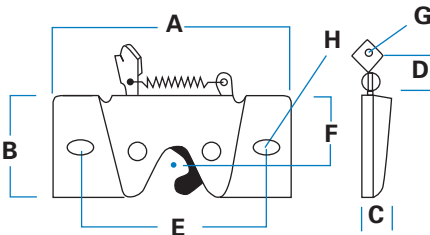

See 9/01875
'turnbutton'
lock



9/00724 Striker,
normally used with
this latch

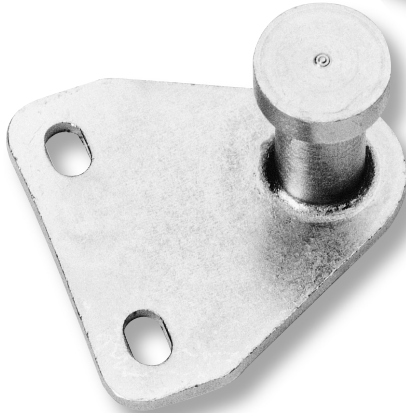

9/00263, RH latch,
shown in 'open' position
with fitted moulded
cover
(latch only is 9/00283)

LH 9/01183

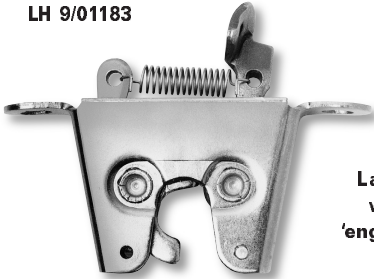

RH 9/00283

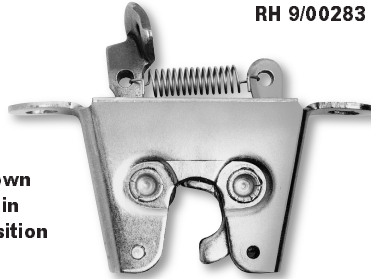

Latches shown
with claw in
'engaged' position

'CLAW' LATCHES TOP-MOUNT

Ideal for top-opening compartments, these latches can be mounted on lid or base without danger of injury from sharp edges, while striker can be placed below opening line. Latches can be operated by direct pressure on top 'trigger' or by remote action. Also suit sliding doors and roller shutters.



Slam-action against pin striker plate. Both 'hands' available as illustrated.



Claw engages with striker and is released by pressure on top trigger or can be operated remotely via cable to hole in trigger plate.



Plant-on fixing through elongated holes in top flanges.



Zinc-plated latch and strikers. Moulded 'buffer' in black pvc.



Use with camlocks or handle with appropriate latch bar. 'Turnbutton' lock 9/01875 can release either directly or by remote cable.



Anti-burst properties
When rig-tested these latches can achieve values in excess of 6.0KN transverse load (direct pull). However they must not be used for passenger restraint doors.

ORDERING CODE

9/00263 Claw latch RH, c/w 'buffer'

9/00283 Claw latch RH, no 'buffer'

9/01183 Claw latch LH, no 'buffer'

9/00724 Pin-type striker

3/21787 Moulded 'buffer' only

SPECIFICATION

A Length	100 mm
B Height	50 mm
C Width	19 mm
D Location	21 mm
E Hole Centres	82 mm
F Location	30 mm
G Hole Size (diameter)	3 mm
H Hole Sizes	7 x 9 mm
Maximum force on trigger to release: 2.5kg	
J Width	51 mm
K Height	35 mm
L Length	51 mm
M Location	32 mm
N Hole Centres	32 mm
O Hole Sizes	5.5 x 9 mm
P Pin diameter	12.5 mm
Q Thickness	3 mm

Striker pins are staked and brazed, hardened and plated.

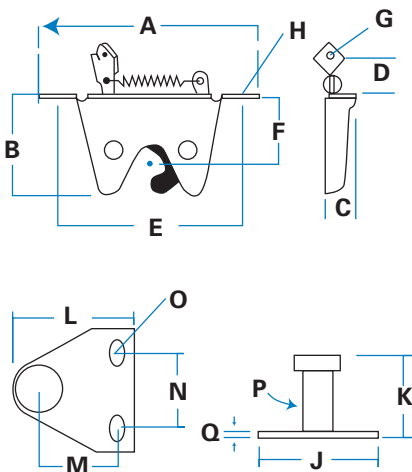

See 9/01875
'turnbutton'
lock

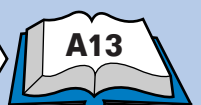







PLATE-TYPE 'CLAW' LATCH

An unusual design in which a rotating pawl engages and releases the operating 'claw'. All motion is in the same plane, allowing the latch to fit into a confined aperture between panels.

Applications include vehicle compartments, partitions and hatches. A special loop-striker and a moulded cover are optional.

-  Anti-burst designs: fitted microswitch indicates if not properly closed.
-  The latch is slammed into a special loop-striker, engaging the 'claw' and trapping the 'nose' of the latch against the reverse of the striker loop as shown.
-  'Claw' is released by a rotating pawl, which has two operating points, for internal and external release.
-  'Plant-on' fixing by three tapped holes in backplate.
-  Zinc plated, with 'claw' encapsulated for appearance, wear-and-corrosion-resistance.
-  Moulded cover for enhanced appearance (retained by screw). Microswitch can be fitted to indicate if not properly closed. Actuator arm can be fitted to release point, allowing latch to be operated by solenoid.

Originally designed as boot latch for Jaguar XJS sports saloon and Daimler limousines.

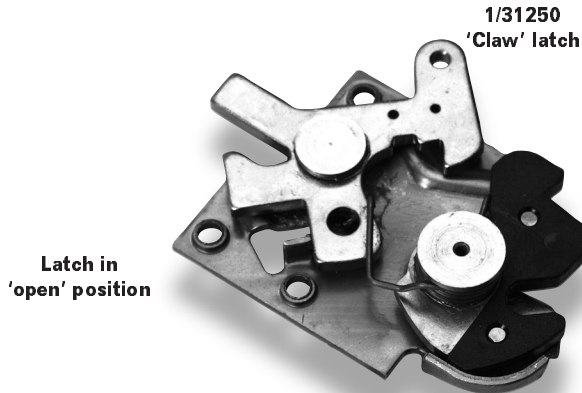
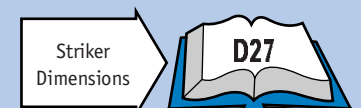

9/01384
'Double-loop'
striker

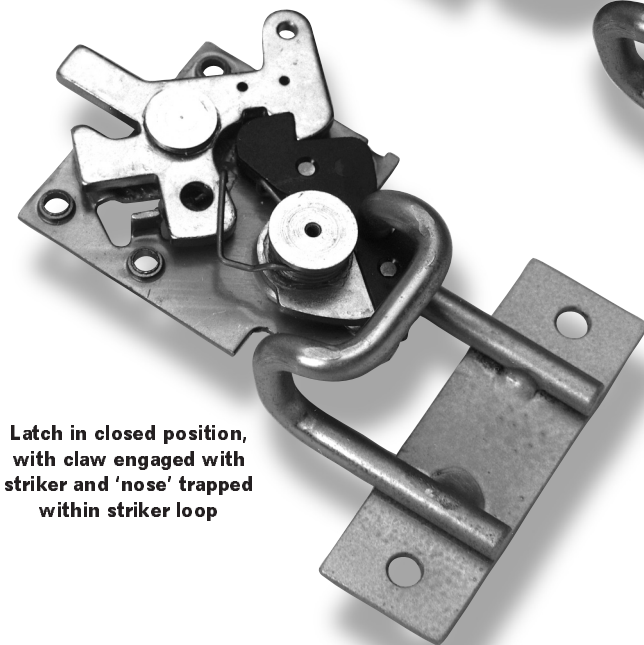

Latch is shown with
rigid moulded cover,
actuator arm,
and microswitch on pawl

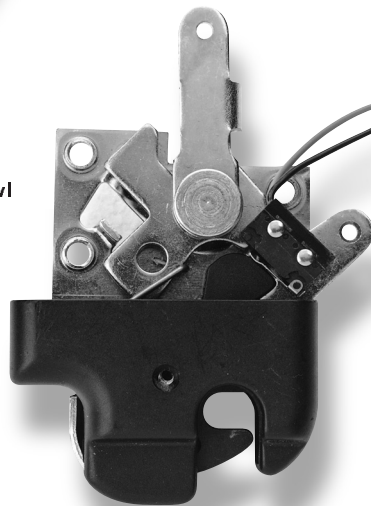

ORDERING CODE

- 1/31250** Plate-type 'claw' latch
- 9/01770** 'Claw' latch with microswitch
- 9/01771** 'Claw' latch, switch and actuator arm
- 9/01769** Moulded cover for 'claw' latch
- 9/01384** 'Double-loop' striker

SPECIFICATION

A Plate length	86 mm
B Plate width	62 mm
C Max. height	17.5 mm
D Lever	30 mm
E Holes tapped	M6
F Hole diameter	Ø 3.8 mm

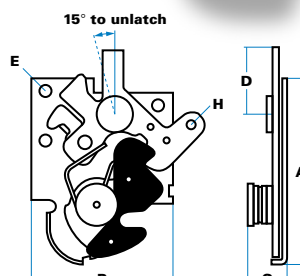

Right-hand
(9/0 0424) in
unlatched position

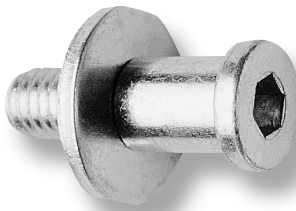

9/00425 Striker

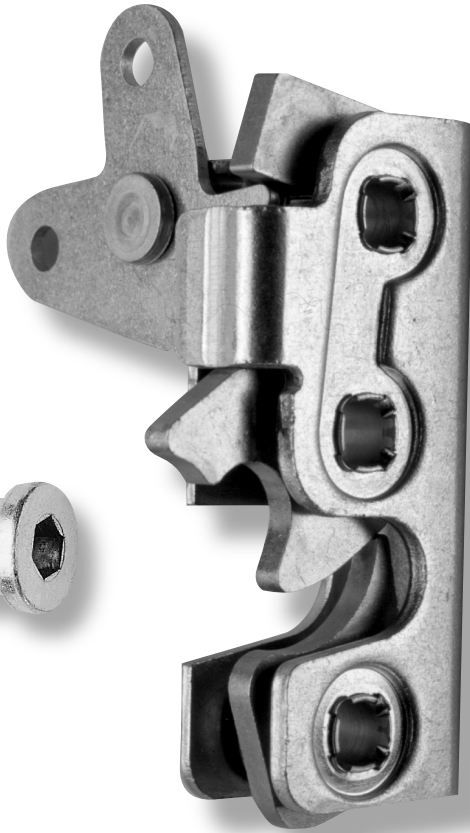

ORDERING CODE

9/0 0423	Rotary latch, LH
9/0 0424	Rotary latch, RH
9/0 0425	Striker pin, (not handed)

SPECIFICATION

A Case length	92 mm
B Case width	40 mm
C Case depth	20 mm
D Location	21 mm
E Pivot to hole	21 mm
F Location	59 mm
G Actuator hole (dia)	6.5 mm
H Mounting hole (dia)	8.0 mm
J Pin head diameter	19 mm
K Surface projection	26 mm
L Total pin length	44 mm
M Washer diameter	30 mm
N Striker pin diameter	14 mm

SAFETY CRITICAL

Right-hand
illustrated

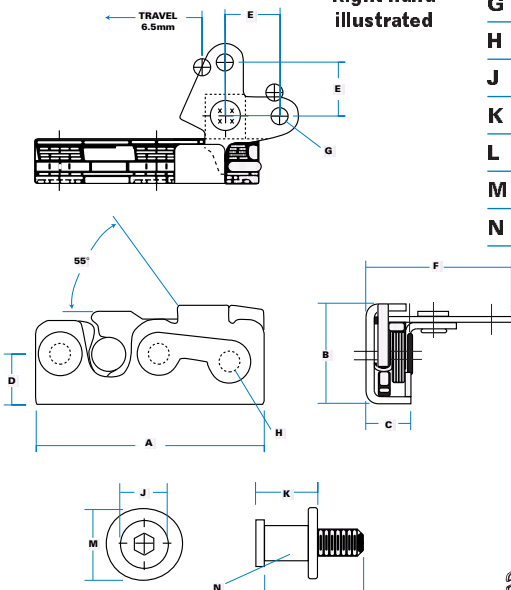



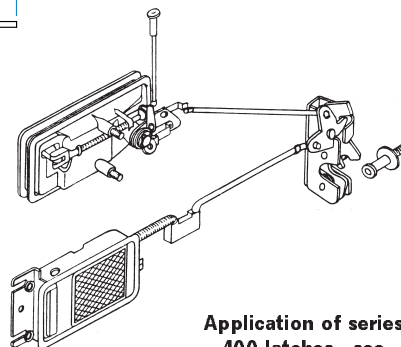



Striker pin head 8mm hex x 4mm deep
Thread form 14 UNC Class 2A



Application of series
400 latches - see
'Flap Handles'

**'SERIES 400'
ANTI-BURST
LATCHES**

The exceptionally neat and compact design of the 'Series 400' makes it suitable for confined spaces and thin doors. It provides 2-stage anti-burst latching, with mounting through the pivot points for great strength.

-  Slam-action against striker pin. Both 'hands' available as illustrated.
-  Claw engages pin with 2-stage action, and is released by pull as shown on 2-lobe actuator arm.
-  Plant-on to edge of door, fixing through body of latch with cut-out for actuator arm.
-  Clear zinc-plated throughout.
-  Alternative actuator arms to special order.
-  Use with 'remote action' handles, turnbuttons, wire and rod linkages, etc.
-  **Anti-burst properties**
When rig-tested these latches can achieve values in excess of 8.9 KN* transverse load in fully-latched condition. However vehicle builders are responsible for evaluating performance in their own particular application and for ensuring that appropriate legislation is satisfied.

* SAE & ECE11 Specification

'FLAP' HANDLES
1/25653-54



B28

See 9/01875
'TURNBUTTON' LOCK

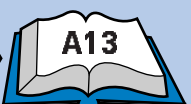

A13









9/01830
Right-hand latch with fitted cover and integral inside handle

ANTI-BURST LATCHES FOR OFF-ROAD VEHICLES

Specially developed for agricultural tractors, construction plant and similar off-road vehicles, these latches are easily fitted to single-skin doors, with a neat, moulded trim cover for good appearance.

Latches operate from a push-button handle mounted on the outside panel, so that plunger engages with 'trigger'.

-  Two-stage rotary action, integral inside release, with fixing holes concealed by trim cover. Steel cover plate reinforces latch to increase strength rating.
-  'Handing' shown for front-hinged doors. Reverse handing for front-opening.
-  Latch slams against pin-striker, is released by exterior 'trigger' or by lifting inside handle. There is no inside locking function.
-  Attach to door edge by 2 x M6 high-tensile bolts through steel cover plate (which must be used). Trim cover is retained by M6 screw into threaded hole on side-face.
-  Black zinc-plated with moulded trim cover and inside release, bright zinc plated striker.
-  When rig-tested these latches can achieve values in excess of 8.9KN (2000lb) Transverse load in fully-latched condition. The design is intended for off-road vehicles, and constructors are responsible for evaluating performance in their own particular application and for ensuring that appropriate legislation is satisfied.

ORDERING CODE

9/01830	Latch assembly, RH
9/01831	Latch assembly, LH
9/01832	Striker pin

Note: Above assemblies include steel cover plate, moulded trim cover and inside release handle.

SPECIFICATION

A Height	80 mm
B Width	47 mm
C Depth	17 mm
D Location to hole	26 mm
E Length, handle	80 mm
F Location to face	9 mm
G Location to latch centre	19 mm
H Hole sizes	6 mm
J Hole centres	31.5 mm
K Hole size (Threaded)	M6
L Pin total length	41 mm
M Threaded	12 mm x 1 mm fine pitch
N Hexagon across flats	16 mm

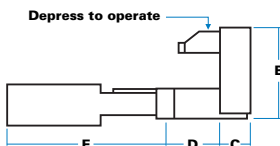
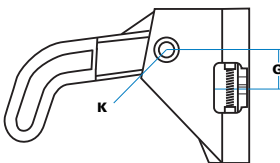
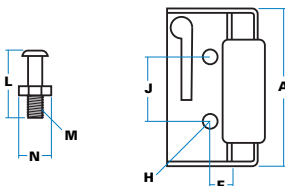

Above drawings include cover plate

View of left-hand latch from exterior, showing 'trigger' for outside release, steel cover plate and moulded trim cover.



3/30476
Right side latch
(visible face)



3/21330
Universal striker
(Plant-on)



ORDERING CODE

3/30476 Disc latch, RH

3/30477 Disc latch, LH

3/22142 Disc latch, RH (Mini)

3/22143 Disc latch, LH (Mini)

3/21330 Loop-striker

Illustration to show operation of actuation levers (right-hand shown)

SAFETY CRITICAL

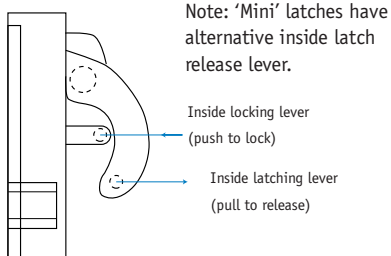
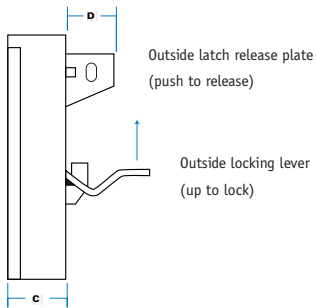

Use connecting clips 1/26869-70

Max travel for inside/outside release of latch 8 mm

Max travel for inside/outside release of lock 10 mm

SPECIFICATION

3/30476
Right-side
illustrated

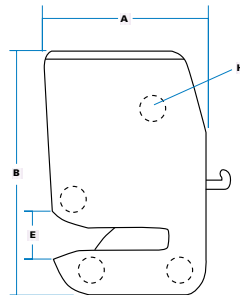

A Max width	66 mm
B Body height	94 mm
C Body depth	21 mm
D Push plate width	20 mm
E 'Throat' height	18 mm
H Holes	c/s 13 mm Ø 7 mm

For other dimensions consult engineering drawing

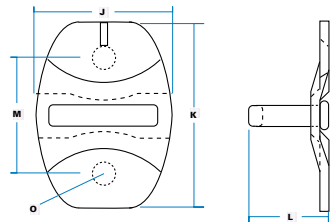

J Max width	45 mm
K Plate height	60 mm
L Loop depth	27 mm
M Hole centres	38 mm
O Hole sizes	c/s 13 mm Ø 7 mm

2020

**'DISC' LATCHES,
PUSH-BUTTON
MODELS**

These models are fully plant-on to the door edge, and operate directly from a push-button unit. The latches have built-in locking functions and fully interconnected inside/outside operation. When correctly fitted they meet legal requirements for on-road vehicles.



Slam-action against loop-striker. Both 'hands' available as illustrated.



Striker loop engages with a slotted steel disc with 2-stage action, and is released by (outside) push-plate or (inside) latching lever. The separate locking levers block operation of latch release.



Fully plant-on to door edge, fixing through body of latch with cut-outs for operating levers.



Moulded body is white, face-plate and striker are bright zinc-plated, other components zinc finish.



Body is acetal co-polymer, face-plate and operating components are steel. Striker plate is hot staked, brazed and hardened.



Alternative inside release.



Use with WBH push-button designs and inside release units.



Anti-burst properties

When rig-tested these latches can achieve values in excess of 8.9KN* transverse load in fully-latched condition. However vehicle builders are responsible for evaluating performance in their own particular application and for ensuring that appropriate legislation is satisfied.

* SAE & ECE II specifications

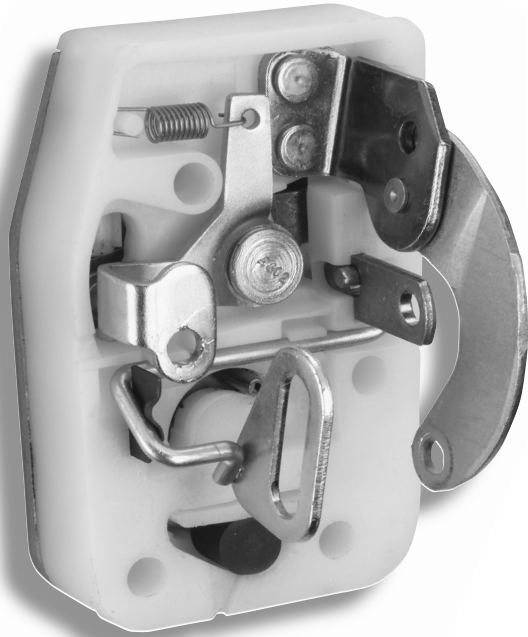

(outside view)

9/02142
Right side latch
showing
operating levers

'DISC' LATCHES, LINKAGE-TYPE

In this design the 'push-plate' (shown opposite) is replaced with a linkage lever, so that the latch can be operated at a distance by connecting rod from a suitable handle. There is also an outside locking lever, which connects to an exterior private lock.

ORDERING CODE

9/02142 Disc latch, RH

9/02143 Disc latch, LH

3/21330 Loop-striker

Illustration to show operation of actuation levers (right-hand shown)

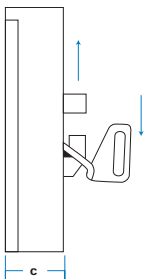

Outside latching (up to release)

Outside locking lever (down to lock)

Inside locking lever (push to lock)
Inside latching lever (pull to release)

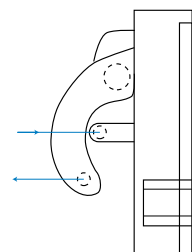

Use connecting clips 1/26869-70

Max travel for inside/outside release of latch 8 mm

Max travel for inside/outside release of lock 10 mm

SPECIFICATION

9/02142
Right-side
illustrated

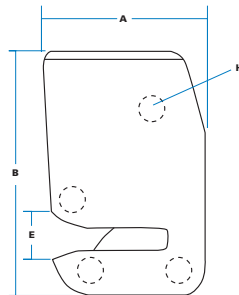

A Max width	66 mm
B Body height	94 mm
C Body depth	21 mm
E 'Throat' height	18 mm
H Holes	c/s 13 mm Ø 7 mm

For other dimensions consult engineering drawing

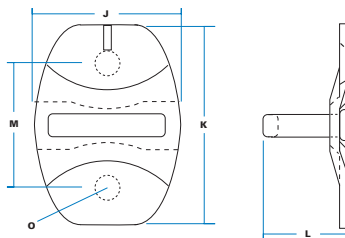

J Striker width	40 mm
K Plate height	78 mm
L Loop depth	30 mm
M Hole centres	51 mm
O Hole sizes	c/s 13 mm Ø 7 mm



Slam-action against loop-striker. Both 'hands' available as illustrated.



Striker loop engages with a slotted steel disc with 2-stage action, and is released by (outside) push-plate or (inside) latching lever. The separate locking levers block operation of latch release.



Fully plant-on to door edge, fixing through body of latch with cut-outs for operating levers.



Moulded body is white, face-plate and striker are bright zinc-plated, other components zinc finish.



Body is acetal co-polymer, face-plate and operating components are steel. Striker plate is hot staked, brazed and hardened.



Alternative inside release.



Use with WBH 'flap handle' designs and inside release units.



Anti-burst properties

When rig-tested these latches can achieve values in excess of 8.9KN* transverse load in fully-latched condition. However vehicle builders are responsible for evaluating performance in their own particular application and for ensuring that appropriate legislation is satisfied.

* SAE & ECE II specifications

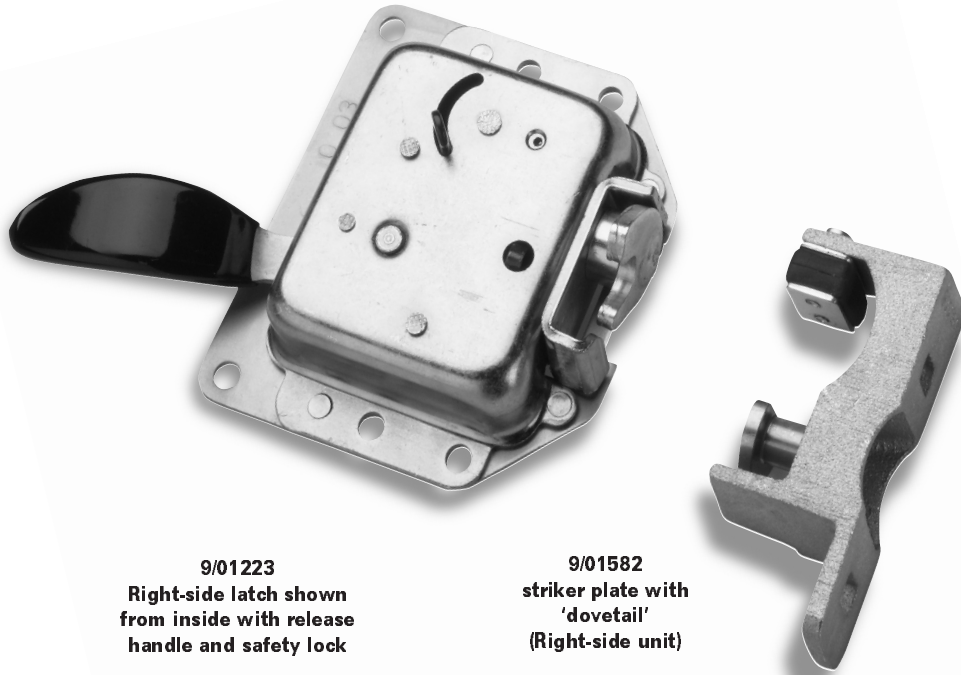

9/01223
Right-side latch shown
from inside with release
handle and safety lock

9/01582
striker plate with
'dovetail'
(Right-side unit)

'PLANT-ON' ROTARY LATCHES

A sturdy plant-on latch, easily installed, with the positive action of a rotary 'claw' combined with the convenience of operation by a directly - mounted handle. Developed from the Land Rover 'Defender' latch series, this is suitable for off-road and specialist vehicles. Not for personnel doors.

ORDERING CODE

9/01223	Rotary latch RH
9/01224	Rotary latch LH
9/01582	Heavy duty striker, RH
9/01581	Heavy duty striker, LH

SPECIFICATION

A	Case Length	115 mm
B	Case Width	127 mm
C	Case Height	30 mm
D	Handle projection	82 mm
E	Inside shaft	8mm sq. x 25 mm length
F	Base To Pin	60 mm
H	Hole Sizes	8 mm
J	Length	105 mm
K	Height	45 mm
L	Width	30 mm
M	Location	25 mm
N	Hole centres	60 mm
O	Hole sizes	8 x 13 mm
P	Pin diameter	12.5 mm

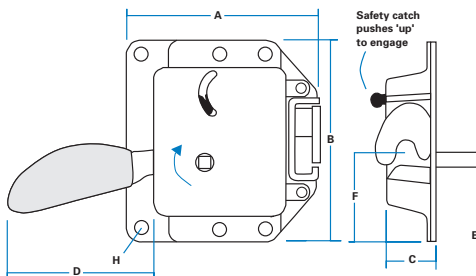

SAFETY CRITICAL

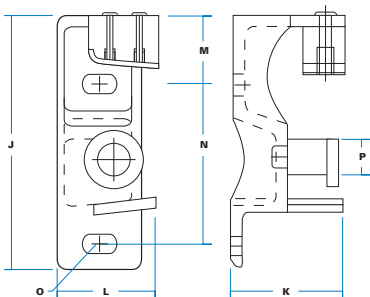

View from outside, with fixed
operating shaft



Latch slams against striker pin, and is released by rotation of inside/outside handle.



Two-stage latching action. Integral safety catch on inside face prevents latch release. Handle must be lifted upward to open.



Fixing onto panel by screws/rivets through 6-off holes in flanges.



Finish is zinc-plated throughout, with black PVC dipped handle.



Options include models with fitted outside handle .



Anti-burst properties
When rig-tested with heavy-duty striker, these latches can achieve values in excess of 8.9KN* transverse load in fully-latched condition. However vehicle builders are responsible for evaluating performance in their own particular application and for ensuring that appropriate legislation is satisfied. * SAE & ECE II specifications



Consult sales office for suitable outside handle options (locking and non-locking)

220

**NEW MODEL
DOOR
HOLD-BACK
with inside release**

This unit is smaller, stronger, and more forgiving of misalignment than our previous model. Completely redesigned as a diecast assembly, it is fitted to the mounting surface through two hollow rivets as shown.

There is an adjustable striker pin, with moulded 'buffer' to cushion impact. The striker is released by gentle pressure on inside handle.

Intended to hold back doors and windows on tractor cabs and similar machines, the pin-&-socket action allows the unit to be used elsewhere, particularly when fitted with linkage for remote-actuation.



9/01951
Holdback and
Striker (Complete)

Adjustable
Striker Pin Assembly

ORDERING CODE

- 9/01951 Door holdback & striker pin
- 5/01664 Moulded handle only, red

SPECIFICATION

A Total Width	78mm
B Faceplate Height	45mm
C Aperture (dia)	18mm
D Case Depth	13mm
E Handle Height	60mm
F Max. Depth	67mm
G Hole Centres	62mm
H Hole Dimensions (dia)	5.5mm
J Striker Total Length	47mm

Total handle movement
either direction to release striker
automatic spring - back centering

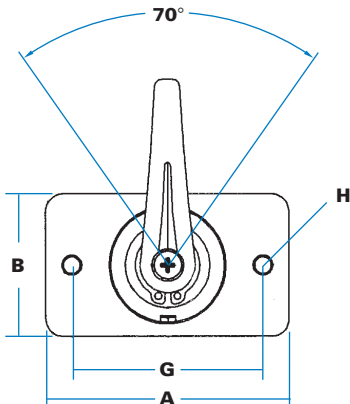

Striker assembly (adjustable)

Comprises threaded steel pin, nut, washers, moulded 'buffer' and steel locking plate. Finish is zinc plated, normally supplied unassembled.

Striker pin
diameter = 8mm

M8 nut, spring washer
& 2-off 30mm washers
provided

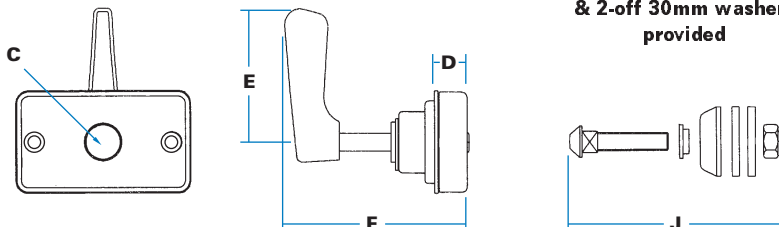

Steel striker is mounted onto door exterior, holdback is fitted into panel so that striker slams into hardened steel jaws.

Gentle pressure on inside handle (in either direction) releases jaws, and a spring ejects striker with some force.

Holdback is inserted through panel cut-out and fixed through two hollow rivets. (Handle can be attached separately). Striker pin threaded and provided with nut, washers and moulded 'buffer'.

Black powder-coated with black moulded handle (optionally red). Striker pin & washers are zinc-plated.

-
- Handle can be fitted at any 90° position
 - Length of operating shaft can be varied to suit door thickness
 - Alternative handles
 - Remote-operated models



9/01351
Holdback and
Striker pin



9/01351/02
Remote-operated model, with
steel lever and cable-hole.

ORDERING CODE

9/01351	Door holdback & striker pin
9/01351/01	Holdback & pin, handle unattached
9/01351/02	Holdback & pin, remote-operated
5/01664	Moulded handle only, red

An adjustable striker can be provided, with moulded buffer. Ask for details.

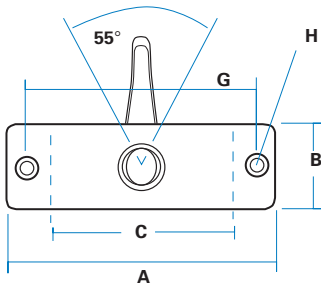

M8 nut, spring washer
& 2-off 30mm washers
provided

Striker pin
diameter = 8mm

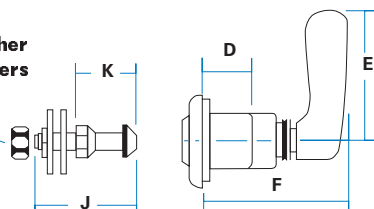

SPECIFICATION

A Total Width	124mm
B Faceplate Height	42mm
C Case Width	94mm
D Case Depth	22mm
E Handle Height	60mm
F Max. Depth	67mm
G Hole Centres	106mm
H Hole Dimensions	6.5mm
J Striker Total Length	47mm
K Closing Length	27mm

Faceplate: Steel, powder-coated.
Gasket: Closed-cell foam
Body: Acetal copolymer.

Striker pin, Machined steel, hardened and zinc-plated.

242

DOOR HOLD-BACK with direct inside & cable release

A neat, lightweight unit which enables a door to be held open (against the body panel), and released from the inside. Usual application is for tractor cabs and similar, but the unit can be adapted for securing lids and compartments.

Note: In some applications this unit has been replaced by the later model, 9/01951



Steel striker is mounted onto door exterior, holdback is fitted into panel so that striker slams into hardened steel jaws.



Gentle pressure on inside handle (in either direction) releases jaws, and a spring ejects striker with some force.



Holdback is inserted through panel cut-out and fixed through two hollow rivets in steel faceplate. (Handle can be attached separately). Striker pin threaded and provided with nut and washers.



Black powder-coated faceplate on black moulded case. Handle shown is red. Striker pin & washers are zinc-plated.



Handle can be fitted at any 90° position. Alternative handles available (retained by screw on 8mm square drive spindle). Remote-operated models

Striker pin length can be varied. Striker can be attached to steel plate for surface-mount applications.



Cycle Testing: The door holdback and striker were mounted on a representative door and were slammed and released for over 50,000 cycles without noticeable wear or damage.



9/01958
Holdback unit,
with striker and
mounting gasket

DOOR HOLD-BACK WITH INSIDE / OUTSIDE RELEASE

A circular hold-back with rotary action, this model has 'jaws' that can be released by levers on both inside and outside. Made in tough, self-coloured moulded materials, it is flange-fitted through three holes to a metal panel and the striker pin is attached to door or window, with a moulded 'buffer' to cushion impact.

These hold-backs are used on tractor and similar machines to hold doors and windows firmly against the side of the cab. Similar models are available for all-glass panels.



As the unit is slammed, the striker pin causes two sprung pins to separate and then close again behind the shaped 'nose'. Action of the operating levers will release the pins, and a sprung central plunger ensures the striker pin is ejected.



Inside or outside release levers are rotated in either direction through approximately 15 degrees to disengage striker pin.



Unit is mounted from outside through a circular aperture and is fixed through three equi-distant mounting holes. A gasket is supplied. Striker pin is secured by single hexagon bolt at rear, also with gasket.



Unit is self-coloured with textured black finish. Striker pin, 'jaws' and entry sleeve are bright nickel-plated.



'O'-ring fixing through varying glass thickness. With/without exterior release lever. Striker pin/buffer length variable

ORDERING CODE

9/01958 Rotary holdback and striker, panel fixing

9/01954 Rotary holdback and striker, for glass fixing

SPECIFICATION

A Total depth	52 mm
B Body diameter	44 mm
C Striker body projection	18 mm
D Striker piercing (dia)	16 mm
E Fixing holes (dia)	54 mm
H Hole sizes (dia)	6 mm

Note : Holdback & Striker are designed to suit 3mm-thick panels.

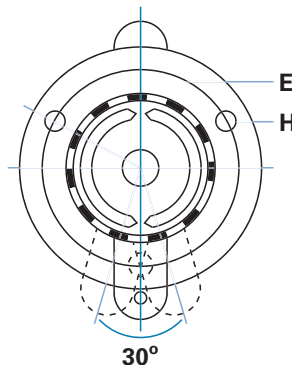
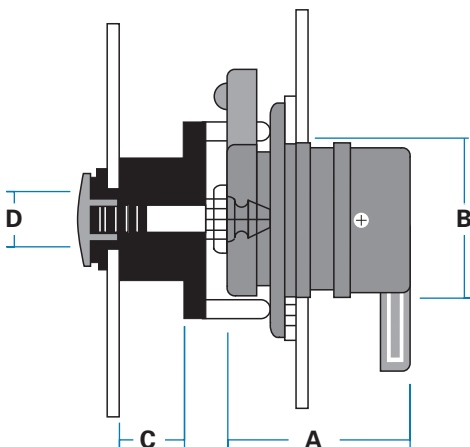



9/01479

ORDERING CODE

9/01479 Hook latch

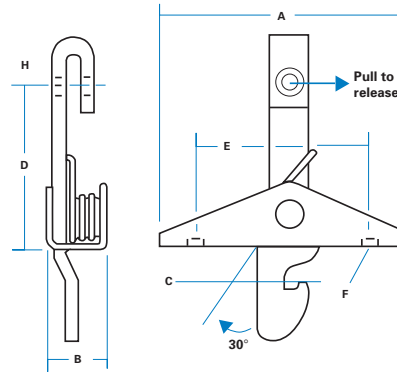

Max. travel of actuating lever is 20mm to give hook movement of 30° approx.

SPECIFICATION

A Case Length	75 mm
B Case Width	20 mm
C Depth Of Hook	17 mm
D Height	47 mm
E Hole Centres	57 mm
F Hole Sizes	5 mm
H Hole Size, (diameter)	6mm c/s 9 mm

**HOOK LATCH
REMOTE-
OPERATED**

This novel design has a spring-loaded hook in 4mm material, mounted into a 'U'-section case. The hook slams against a pin or slot and is released by side ways 'pull'.
Finish is zinc-plated



ORDERING CODE

9/01936 Diecast snap-catch

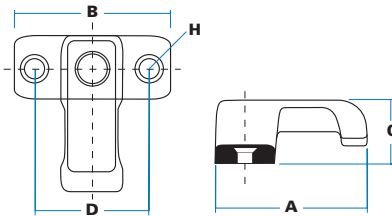

SPECIFICATION

A Arm length	47 mm
B Plate length	48 mm
C Height	19 mm
D Hole Centres	35 mm
H Hole Sizes (dia)	c/s 4 mm

**DIECAST
SNAP-CATCH**

A clever little catch, used for holding hatches and panels in either open or closed positions. A concealed spring and 'detente' holds the arm securely in position. Finished in black powder-coating and suitable for inside or external fitting.



9/01828 (set)

ORDERING CODE

9/01828 Outside hold-back (set)

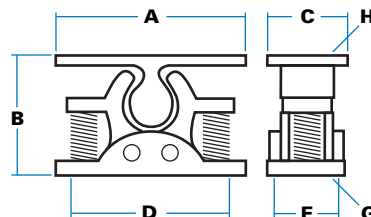

SPECIFICATION

A Length	65 mm
B Depth (closed)	41 mm
C Width	30 mm
D Hole centres	55 mm
E Hole centres	17mm
G Base hole sizes (dia)	4 mm
H Top holes (slots)	4 mm x 9 mm

**OUTSIDE HOLD-
BACK
[CORROSION-
RESISTANT]**

A useful exterior slam catch, with white nylon 'jaws' supported on stainless coil springs for smooth action and strong retention. Pull-out force for separation is 15 Kg.

9/01383 Catch in
'open' position



9/01384 Double
loop striker

Catch in
'closed' position

ORDERING CODE

9/01383 Hold-down catch

9/01384 Double loop striker

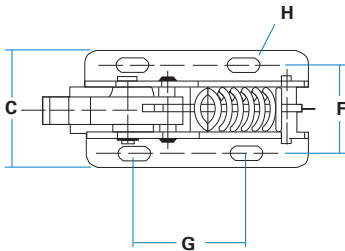
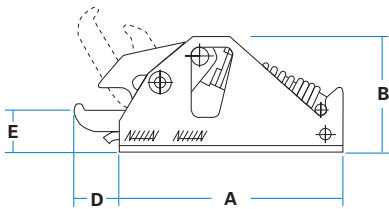

SPECIFICATION

A Case Length	110 mm
B Case Height	56 mm
C Case Width	58 mm
D Projection	21 mm
E 'Claw' Height	21 mm
F Hole Centres	44 mm
G Hole Centres	55 mm
H Hole Sizes	16.5 x 6 mm

J Height Of Loop	60 mm
K Width Of Loop	50 mm
L Hole Centres	70 mm
M Projection	45 mm
N Plate Width	30 mm
O Hole Size	8 mm

The 'Double-loop' striker provides great freedom in the mounting positions of catch and striker.

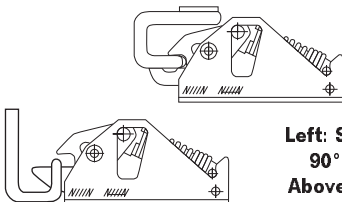

Left: Striker is at
90° to catch
Above: Striker is
parallel with catch

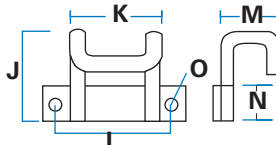

120

INSIDE HOLD-DOWN CATCH over-centre action

A robust and simple plant-on unit which uses over-centre action to trap and hold down the striker-loop. Widely used for engine covers, grills, luggage compartments and for machine covers and canopies.



The catch is mounted on cover or base, and simply slams against a striker. Release is by direct pull away from striker, usually using a grab handle. Pull -out force is 20kg (55lbs)



Slam-action causes moulded 'claw' to rotate through 60°, bringing the powerful spring over-centre to trap and hold down the striker loop.



Fixing through four elongated holes in base-plate.



Steel parts are zinc-plated. 'Claw' is glass-filled nylon in black.



Use with grab handles 9/01526, 9/00214 or similar.

DOOR BUFFER ASSEMBLY

Moulded buffer with steel insert threaded M8, together with two steel spacing washers. Cushions door closure, prevents rattle.



9/01968

Buffer height 10mm x 30mm diameter. Black, with plated insert.

MOULDED OVER-CENTRE CATCH

This is a smart panel-fastener ('draw latch'), made completely in tough, self-colour moulded material (glass-filled nylon) to eliminate any possibility of corrosion. A simple finger-loop provides positive lock-down engagement, which can be replaced by a padlock if desired.

! The reinforced 'hook' is brought over the striker plate, and the centre section is pressed down to achieve over-centre action. Maximum 'draw' is 20mm. The press-fit finger-loop secures centre to base-plate.

+ Fully plant-on, secured by bolts or rivets to panel surfaces.

+ Black self-colour with lightly textured finish.

PADLOCKABLE OVER-CENTRE CATCHES

Steel over-centre catches with loop for padlock and hooked striker plate. Two body lengths are available as shown, with maximum 'draw' of 20 mm. Finish is clear zinc plated, with black, or stainless steel to special order.



9/01984
Catch & striker
assembly

ORDERING CODE

9/01984 Moulded over-centre catch
& striker assembly

SPECIFICATION

A Length (overall)	125 mm
B Width	25 mm
C Height (max)	26 mm
D Hole centres (base)	33.4 mm
E Hole Sizes	5 mm c/s 8 mm
F Max 'draw'	20 mm

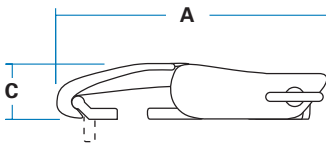
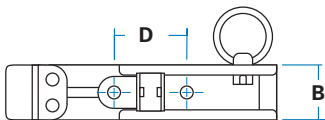

9/00285
Short catch &
Striker Plate

9/00284
long catch &
Striker Plate

ORDERING CODE

9/00284 Overcenter catch/hook - long

9/00285 Overcenter catch/hook - short

SPECIFICATION

A Length (long model)	130 mm
Length (short model)	66 mm
B Width	25 mm
C Height	20 mm
D Loop Diameter	10 mm
E Hole Centres	34 mm
F Hole Centres	32 mm
G Max. Open	52 mm (short) 80 mm (long)
Closed	42 mm (short) 60 mm (long)
H Hole Sizes	5 mm

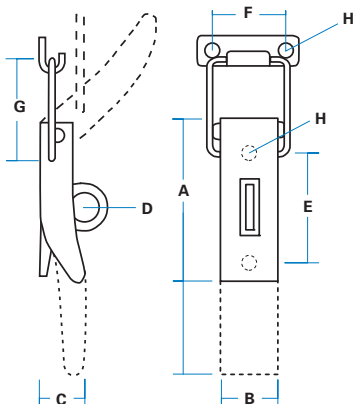



9/02094
locking unit
c/w striker plate

9/02096
non-locking unit
c/w striker plate

ORDERING CODE

9/02094 Locking unit, with
striker plate, black

9/02094/01 As above, FT 111

9/02096 Non-locking unit, with
striker plate, black

SPECIFICATION

A Total Length	212 mm
B Length to striker pin	120 mm
C Max width (base)	96 mm
D Length (base)	30 mm
E Max width (strickers)	93 mm
F Hole centres (strickers)	58 mm
G Hole centres (base)	75 mm
H Hole Sizes (base)	8.5 dia
I Hole Sizes (striker)	8.5 x 20 mm
J Length (striker)	72 mm
K Max height (not shown)	42 mm

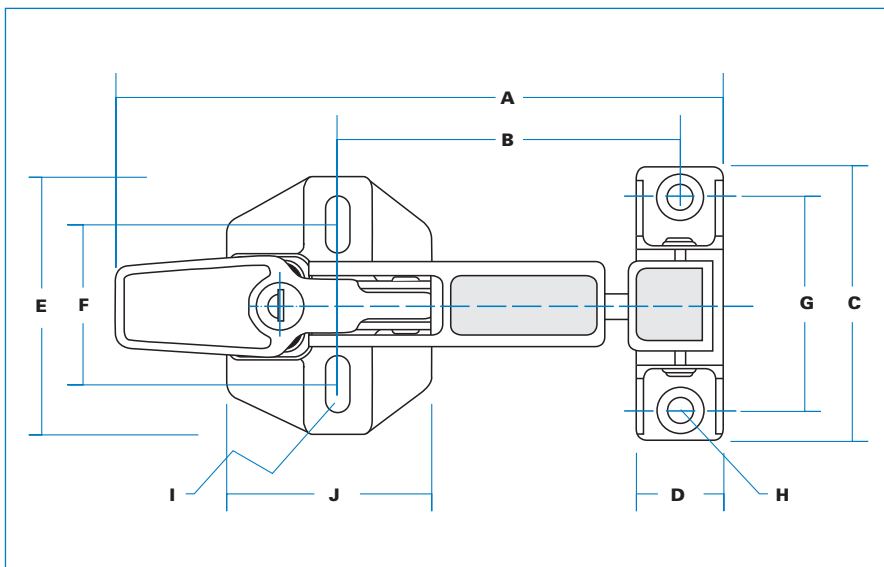

**OVER-CENTRE
FASTENERS
HEAVY DUTY
APPLICATIONS**

This robust catch incorporates a strong coil-spring which gives leveraged over-centre action against a stainless steel rod, mounted on a striker plate, with slotted mounting holes to allow for easy adjustment.

Cleverly designed as a diecast assembly for good appearance, the catch is generally used to secure fabricated covers or access doors on large earthmovers and similar applications. It is available in both locking and non-locking versions.



Base-plate is mounted on fixed member, striker plate is mounted on mating panel. The catch body is brought down so that operating 'claw' engages with striker pin, and the pivoted lever-handle is then pressed down to achieve over-centre action, forcing panels tightly together.



Action of lever-handle extends spring-loaded plunger, holding catch tightly in position and preventing 'rattle'. On locking versions, lock cylinder secures handle against striker plate.



Completely plant-on fixing, by bolts or rivets through mounting holes (slotted for adjustment on striker plate).



'FT' or optionally 'FS' key types. Non-locking version available.



Black powder-coated as standard. Optionally, clear zinc plated.



Special key types, key numbers, and sets.

1/27106
(Serrated base)

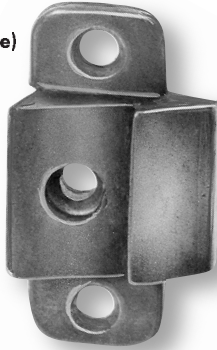

Versatile 2-step design, used with "Mini" slam latches and similar models.

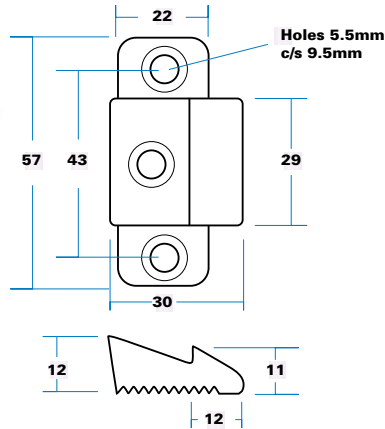

1/27107
(Serrated base)

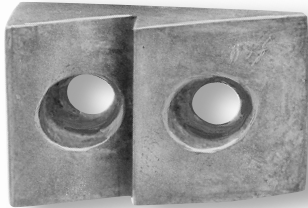

2-step striker for thicker doors/frames with longer depth of travel for full closure. Suits 'Mark 50' heavy-duty slam latches, etc.

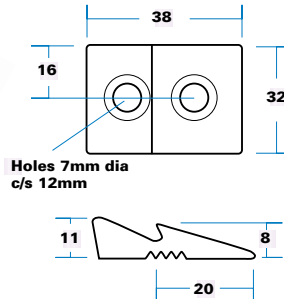

1/27113
(Serrated base)

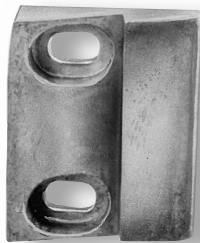

Useful 2-step striker with adjustable mounting holes. Use with most slam latches, 'paddle' latches, etc.

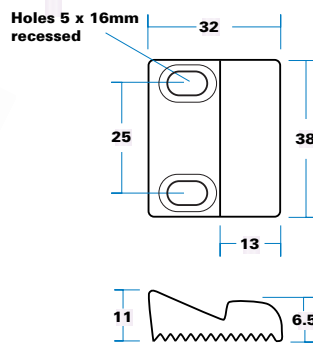

3/12341
(Plain base)

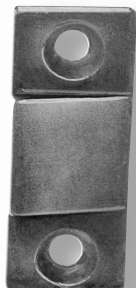

Standard with 2 & 3-way slam systems. Use with end-bolts, moulded slam latch 9/01530, etc.

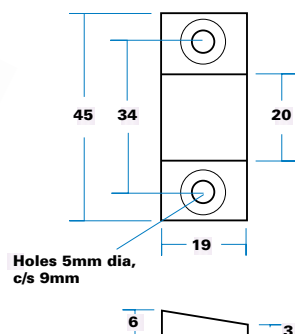

3030

DIECAST STRIKER PLATES

These strikers should be used with our various slam latches to protect door edges and ensure full engagement. Choice of striker will be determined by depth of door/pillar and clearance when closed. All units are zinc diecast and clear zinc-plated.

3/13521 Pin



3/13520 Plate

ALIGNMENT PLATE & PIN

The steel pin is usually fitted to the door frame and plate to the door edge. As door closes, the 'shoulder' on the pin is drawn into the shaped slot and provides firm and positive support. Zinc-plated. Request dimensions from sales office

CONTROLS

**INSIDE
RELEASES,
WINDOW
HANDLES &
SUPPORT STAYS**

This section contains a varied assortment of products for controlling operation of doors and windows. Also included are support stays, which find application in all types of boxes, front-opening panels, and large enclosures.



These elegant handles are variations on a theme - with centre-screw fixing, concealed fix, or accepting an externally-threaded shaft (dome-nut supplied)

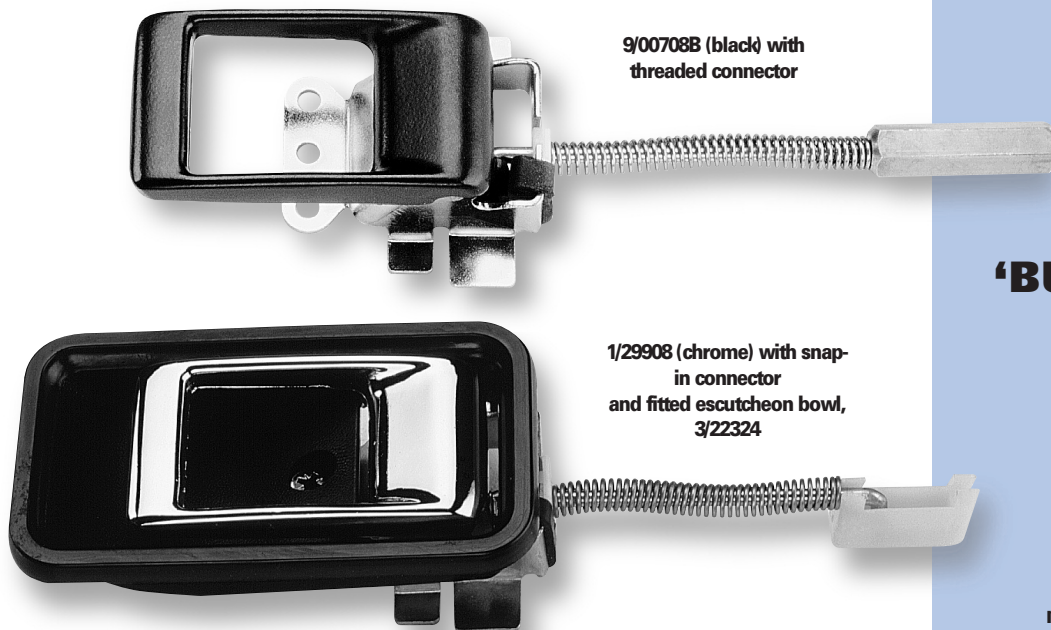

'BUCKLE' INSIDE RELEASE HANDLES

A neat, automotive design which is very easy to fix. There is no locking feature, so it is used on doors where inside locking is achieved by sill-button or other means. Two styles of connector as shown, non-handed.

ORDERING CODE

1/29908	'Buckle' release, chrome, (snap-in)
1/29908B	As above, black
9/00708	'Buckle' release, chrome (threaded)
9/00708B	As above, black
3/22324	Moulded escutcheon bowl, black
9/00078	Connector rod, 3.5 mm x 1 metre
7/26668	Sill-button, black

Special Models

Threaded connectors can be provided to alternative threads/lengths and with other features to facilitate attachment.

Installation of 'buckle' release

Illustration shows inside handle with simple connection to latch.

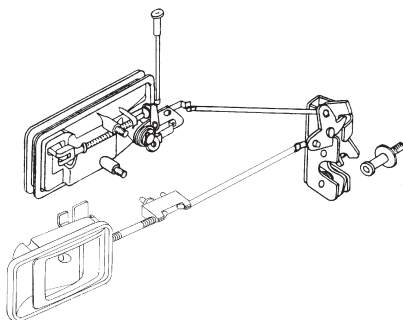

This is an installation using our outside 'flap' handle, 1/25653, with 'freewheeling' action. See section B.

SPECIFICATION

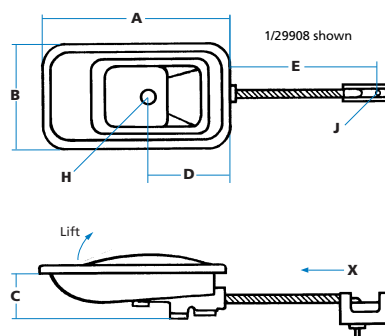

A	Bowl total length	102 mm
B	Bowl width	55 mm
C	Depth to base	23 mm
D	Location	45 mm
E	Location to 'J'	75 mm
H	Hole size (dia)	5 mm
J	Hole size (dia)	3.5 mm
X	Travel of latch release	15 mm

A rubber buffer on the frame acts as a stop, 'cushioning' action and preventing rattle.

Adjustable connector (9/00708, etc)

Hexagonal brass connector, length 40 mm, threaded 10/24 UNC (RH thread) allows 5 mm of adjustment.

Adjustable connector (9/00708)

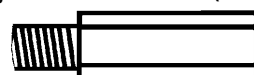

Semi-plant-on for easy installation, cushioned action and choice of finish options.



Lift flap to withdraw latch connection point 'X'



Handle is bolted to inside door skin through base, and connected to latch. Trim panel is fitted, and moulded escutcheon is slipped over 'buckle' and secured through centre hole, concealing edges of panel.



Bright chromium-plated or black buckle, on zinc-plated frame. Black escutcheon.



Zinc diecast 'buckle' on steel frame, with bowl moulded in ABS.



Alternative connectors



Anti-burst latches (pages D20-21)



7/26668
sill button

Moulded in black ABS with plain core, self-taps onto thread-rolled rod (4.2 mm diameter)



1/29774 (RH)
illustrated with trim
bezels 3/14422

'FLUSH CASE' INSIDE RELEASE HANDLES with safety flap

Widely used through several generations of cars, vans and trucks, the 'flush-case' is strong, attractive, and easily fitted. There is a safety flap for internal locking, which provides visual indication that a door is secured.

! Semi-plant-on design for easy installation and adjustment, 'snap-in' connection, cushioned action, and wide choice of finish options.

W Lift flap to withdraw latch connection point 'X'. Safety flap operates separate connecting link to door latch, and blocks main flap.

M Handle is bolted to inside door skin through elongated hole/slots in brackets at each end. Link rods are pressed into connector block and into hole at (either) side of safety flap. Trim panel is fitted over handle, 2-piece bezels will conceal gaps.

W Case is powder-coated black or grey, or bright chromium plated. Standard moulded flaps are black or grey with 'quilted' pattern. Optionally, diecast main flap with smooth finish in black or chrome.

M Mild steel case with flaps moulded in ABS (or diecast main flap).

+ Use with 'disc' latches or similar (pages D20-21)

ORDERING CODE

1/29774	Flush case, RH, black
1/29775	Flush case, LH, black
3/15610	Flush case, RH, chrome/black flaps
3/15611	Flush case, LH, chrome/black flaps
3/15610/01	Flush case, RH, chrome/chrome flap
3/15611/01	Flush case, LH, chrome/chrome flap
3/14422	Trim bezel, black (2 required)
9/00078	Connector rod, 3.5 mm x 1 metre

SPECIFICATION

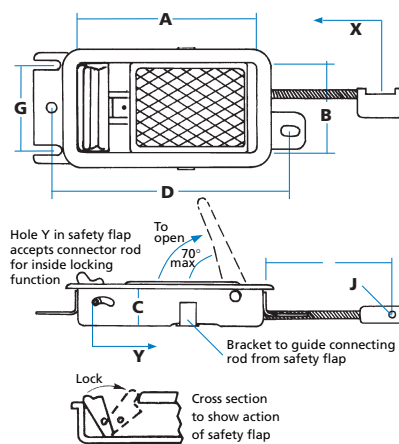

A Case length	112 mm
B Case width	58 mm
C Case depth	20 mm
D Hole centres	145 mm
E Location to 'J'	75 mm
F Flange depth	15 mm
G Location	50 mm
H Hole size	6 x 12 mm
J Hole size (dia)	3.5 mm
X Travel of latch release	15 mm
Y Travel of lock release	10 mm

Installation of 'flush case'

Illustration shows right-side handle with fully interconnected action through door latch to outside handle (See 'Flap handles').

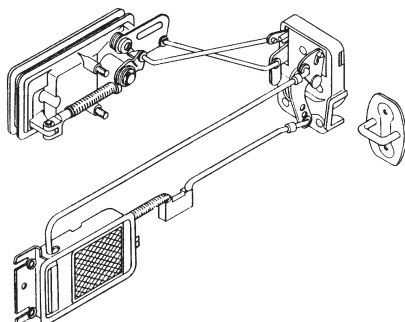

'Handing'

'Flush cases' are handed by position of connector block and small bracket.

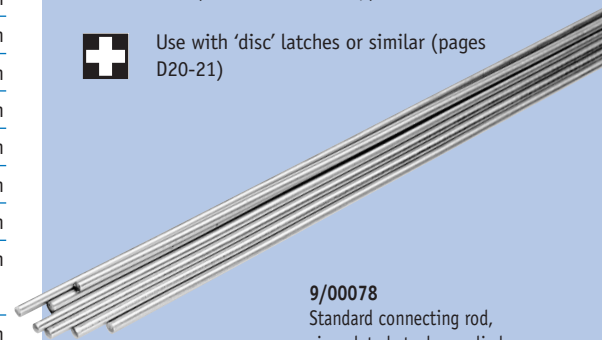

9/00078

Standard connecting rod, zinc-plated steel, supplied in straight 1-metre lengths.

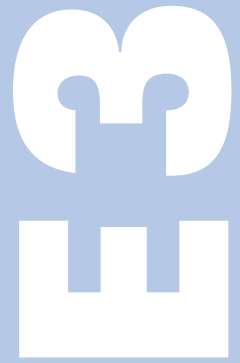

1/29902 (RH) illustrated with diecast chrome flap and trim bezels 3/14422.

'FLUSH CASE' INSIDE RELEASE HANDLES without safety flap

These versions of the 'flush case' suit internal doors where no safety flap is required, or where inside locking is achieved by other means (for example, by sill-button).

! Semi-plant-on design for easy installation and adjustment, 'snap-in' connection, cushioned action and wide choice of finish options.

W Lift flap to withdraw latch connection point 'X'.

M Handle is bolted to inside door skin through elongated hole/slots in brackets at each end. Trim panel is fitted over handle, 2-piece bezels will conceal gaps.

+ Case is powder-coated black. Standard moulded flap is black with 'quilted' pattern, optionally, diecast with smooth finish in black or chrome.

M Mild steel case with flap moulded in ABS or zinc diecast.

? - Threaded connector for adjustment.
- Special models with extended travel ('X' = 26 mm)

+ Use with 'Series 400' latches or similar (page D18)

ORDERING CODE

1/29450	Flush case, RH, black
1/29451	Flush case, LH, black
1/29902	Flush case, RH, black/chrome flap
1/29903	Flush case, LH, black/chrome flap
9/01013	Flush case, RH, threaded connector
9/01014	Flush case, LH, threaded connector
3/14422	Trim bezel, black (2 required)
9/00078	Connector rod, 3.5 mm x 1 metre

Special models

Using a different arrangement of operating links, connector travel ('X') can be increased to 25 mm for more positive latch release action (request 1/30601-2).

Installation of 'flush case'

Illustration shows right-side handle with simple connection to latch (See 'Flap handles').

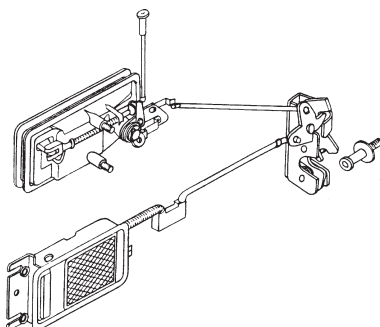

'Handing'

'Flush cases' are handed by position of connector block and small bracket.

SPECIFICATION

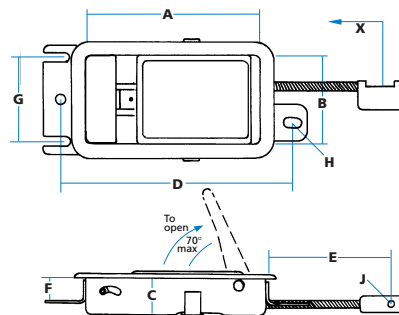

A	Case length	112 mm
B	Case width	58 mm
C	Case depth	20 mm
D	Hole centres	145 mm
E	Location to 'J'	75 mm
F	Flange depth	15 mm
G	Location	50 mm
H	Hole size	6 x 12 mm
J	Hole size (dia)	3.5 mm
X	Travel of latch release	15 mm

THREADED CONNECTORS



Connector block, 3/14493

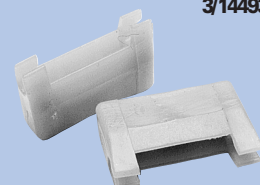

Useful nylon connector which accepts two pieces of linkage rod.



'WASHBOARD' INSIDE RELEASE HANDLES

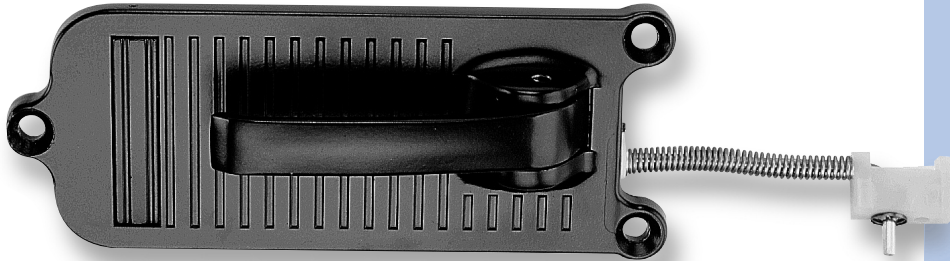

9/01597 (RH)
illustrated

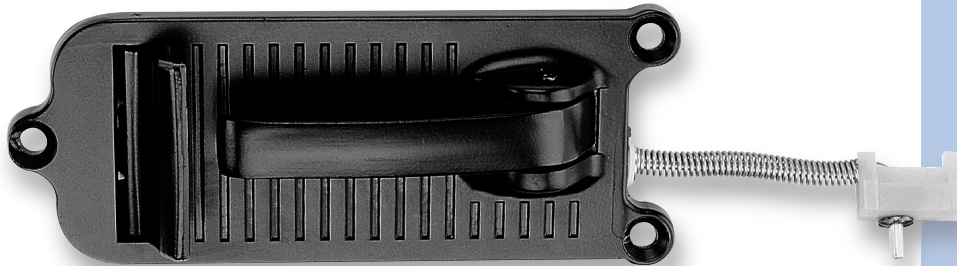

1/26650B (RH)
illustrated, showing
safety flap in 'locked'
position

The 'washboard' release represents an evolutionary stage between conventional 'rotary' inside handles and fully-flush designs. It is a diecast unit with a 'pull-out' handle that affords good grip, while sitting low against the side of the vehicle when in rest position.

Originally made for luxury cars it also suits trucks and buses and can be supplied with or without safety flaps as illustrated.

! Semi-plant-on design for easy installation, 'snap-in' connection, cushioned action, can be polished and plated to high standards of finish.

W Lift flap to withdraw latch connection point 'X'. Safety flap (when fitted) operates separate connecting link to door latch, and blocks main flap.

M Handle is fitted to inside door skin, link rods are attached, and trim panel is applied over ends of handle to conceal bolts.

P Black powder-coated as standard, optionally bright chromium-plated.

M Zinc diecastings with steel connecting links.

? Alternative connectors.

+ Anti-burst latches (pages D20-21)

ORDERING CODE

1/26650B	'Washboard', with safety, RH, black
1/26649B	'Washboard', with safety, LH, black
9/01597	'Washboard', no safety, RH, black
9/01596	'Washboard', no safety, LH, black

Installation of 'washboard' release

Illustration shows right-side handle with fully interconnected action through door latch to outside handle. With original scheme a push-button exterior handle was used.

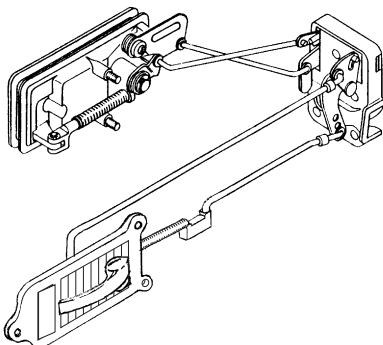

'Handing'

Separate base castings, handed by position of connection points and release handle.

SPECIFICATION

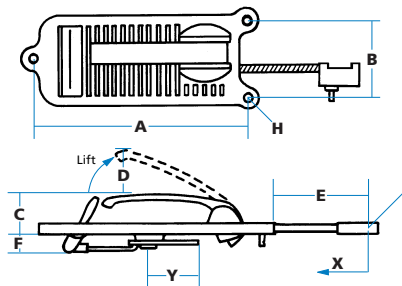

A Length (between centres)	155 mm
B Width (between centres)	53 mm
C Max height (at rest)	28 mm
D Max. travel	50 mm
E Location to 'J'	75 mm
F Max. depth	15 mm
H Hole sizes	6 mm (dia) c/s 12 mm
J Hole size (dia)	3.5 mm
X Travel of latch release	15 mm
Y Travel of lock release	22 mm

Note: Lock release lever 'Y' has two attachment points, allowing for adjustment of linkages on site.

Linkage clips

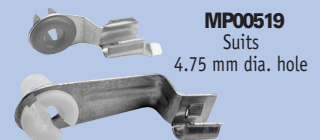

1/26869-70

Suits 5.5 mm dia. hole

All accept standard connecting rod.

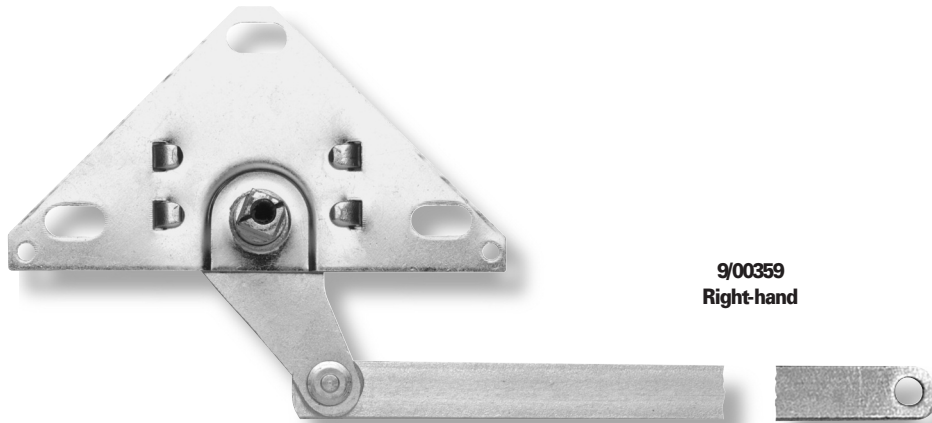
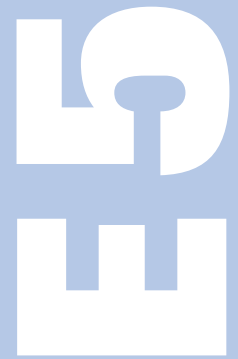

9/00359
Right-hand

'TRAIL-PLATE' INSIDE RELEASE & HANDLES

Highly versatile units which allow door latches to be operated from a handle some distance away. Particularly useful on wide doors, trucks, and off-road vehicles.

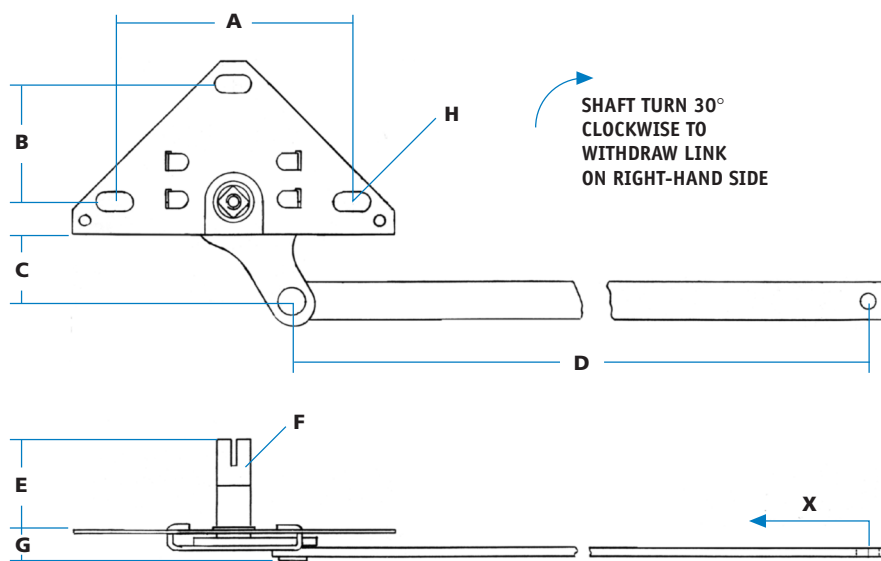

! Units are 'handed' LH/RH with a 8 mm-square (5/16") spindle, aligned at 45° to vertical, with provision for safety locking (see below).

W Pull inside handle as shown, withdrawing link bar and operating latch. Push in other direction to lock handle into a détente.

↕ Install as shown to achieve correct movement on each side of vehicle. Units may be inverted to reverse movement of link bar.

≡ Semi-plant on, with slotted holes for adjustment, and normally covered with trim panel.

🔧 Zinc-plated mechanism. Handles are chromium-plated.

? - Alternative spindles (length, alignment)
- Special link bars to order.

+ Use with inside handles shown, and with rotary latches (D18) or similar.

ORDERING CODE

9/00359 Inside release, RH

9/00360 Inside release, LH

SPECIFICATION

A Length (between centres)	80 mm
B Width (between centres)	40 mm
C Projection	22.5 mm
D Link bar	380 mm
E Spindle height	32 mm
F Spindle tapped	15 mm x 10-32 UNF
G Rear projection	10 mm
H Hole sizes	6 x 13 mm
X Travel of latch release	25 mm

Inside handles

E 6-10

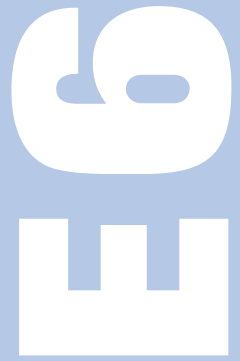

Adaptor Shim
1/07995

This useful spring-steel adaptor allows inside handles on this page (9.5 mm square core) to be used with 8 mm square shafts.

Fixing screw
handles have recessed hole to accept fixing screw, ref 24-16.

INSIDE RELEASE HANDLES

(Screw-Fixing to 9.5 mm square shaft)



1/24212
'Webbed' Style

NOTE: A matching window handle is available as 1/24214

1/24212

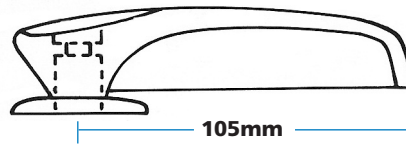

Height (max) - 28mm
Top recess 10mm diameter x 4mm deep

'Webbed' Style

Strongly-styled handle with 'webbed' sidewall, in black ABS with chrome-plated diecast base-plate. Screw-fixed into 9.5mm (3/8") square core, in-line with axis.

(was BL 'mini', etc.)



1/08438
'Fishtail' Design

1/08438

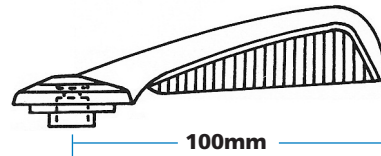

Height (max) - 25mm
Top recess 13mm diameter x 4mm deep

'Fishtail' Design

'Fishtail' design on sidewall, diecast and finished in bright chromium plating. Screw-fixed into 9.5mm (3/8") square core, in-line with axis. May require spacer ring, (5/01595).

(was Ford, Triumph, etc)



1/12000
'Traditional' Model

1/12000

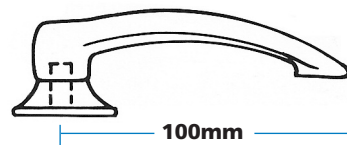

Height (max) - 35mm
Top recess 8mm diameter x 5mm deep

'Traditional' Model

'Traditional' model with high grip and integral skirt, diecast and chromium plated. Screw-fixed into 9.5mm (3/8") square core, in-line with axis.



1/11818
'Slimline' Handle

1/11818

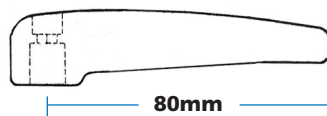

Height (max) - 23mm
Top recess 8mm diameter x 10mm deep

'Slimline' Model

Very elegant little handle with low height and smooth sidewalls. Screw-fixed into 9.5mm (3/8") square core, in-line with axis.



SN003



Standard 8 mm steel shaft, with chamfered corners, supplied in 150 mm lengths, bright zinc -plated

INSIDE RELEASE HANDLES

(Screw-Fixing to 8mm square Shaft)

Moulded handle



5/01664
(black)

5/01664

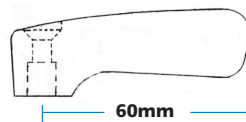

Height (max) - 25mm
Top hole diameter 6mm,
countersunk 10mm

Moulded Handle

A small, tough, useful handle made in wear-resistant Acetal, with fine-sparked finish. Normal colour is black, red also available. 8mm square core, in-line with axis.

'Traditional' handle



1/11930
1/11930B

1/11930

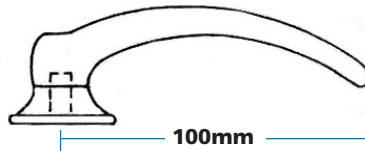

Height (max) - 40mm
Top recess 13mm diameter x 4mm deep

'Traditional' Handle

Diecast-handle with high grip and integral 'skirt'. Available in chrome or black powder-coated. 8mm square-core, in-line with axis

'Spade-end' handle



1/05171

1/05171

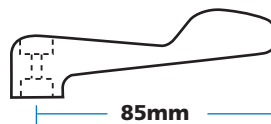

Height (max) - 30mm

'Spade-end' Handle

Diecast handle, useful for restricted spaces. Available in chrome only. 8mm square core, in-line with axis.

'Heavy-duty' handle



9/00801
9/00801B

9/00801

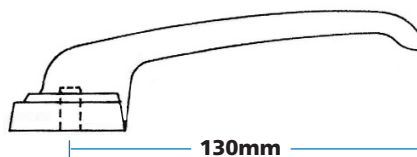

Height (max) - 40mm
'Skirt' diameter - 45mm

'Heavy-duty' Handle

A substantial handle developed for heavy trucks and also used for electrical control gear. Diecast, with chrome or black finish. 8mm square core, in-line with axis.

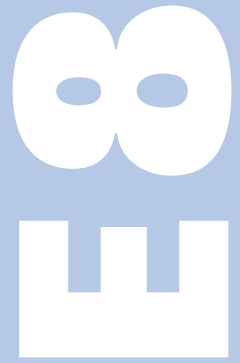

INSIDE RELEASE HANDLES CONCEALED-FIX MODELS



1/16420
Spring escutcheon
for 'traditional' handles
chrome plated

'Truncheon' Handles

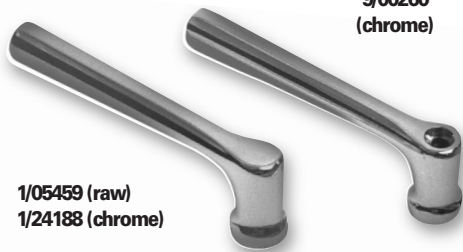

1/05459 (raw)
1/24188 (chrome)

9/00260 (chrome)

1/05459 (raw, drive-fit)
9/00260 (chrome, screw-fix)



100mm
Height _____ (max) 40mm

Centre hole in top face (when supplied),
6mm x 10mm c/s.

'Truncheon' Handles

A useful design with two versions. The plain handle is driven onto a shaft and is drilled & pinned. Otherwise, a centre hole is provided for screw fixing. 8mm square hole, in-line with axis. Finish is raw or chrome (black optional)

'Pin-Fix' Handles

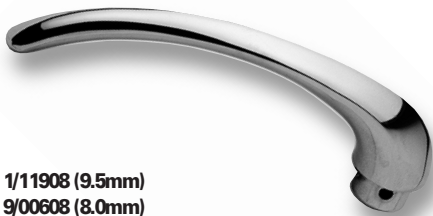

1/11908 (9.5mm)
9/00608 (8.0mm)

NOTE: A matching window
handle is available as 1/12308

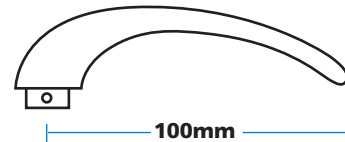

100mm
Height _____ (max) 25mm

Secure through pre-drilled holes
in base using pin 121-3.

Traditional 'pin-fix' Handles

A slim, curved handle fixed by pinning through pre-drilled holes in base.

Two versions are available.

1/11908, with 9.5mm square core
9/00608, with 8.0mm square core

A spring-escutcheon covers base of handle for neat appearance. (order separately)

'Modern' Handle



9/00239
NOTE: A matching window
handle is available as 9/00232

9/00239

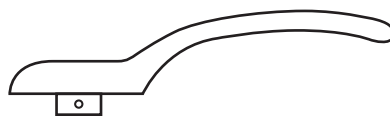

100mm
Height _____ (max) 25mm

Secure through pre-drilled holes
in base using pin 121-3.

'Modern' Handle

A modern car handle with attractive styling. It has 9.5mm (3/8") square core, in-line with axis, and is secured by pre-drilled holes in base. The adapter shim, 1/07995, can be used for 8mm square shafts.



9/00802
9/00802B

concealed
grub-screw

9/00802 & 9/00802B

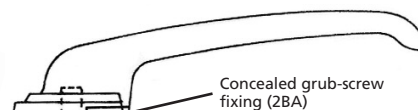

130mm

Height (max) - 40mm
'Skirt' diameter x 45mm

'Heavy-duty' Handle

A substantial handle, fixed by concealed grub-screw in 'skirt'. Finish is chrome or black, Square core at 8mm (5/16"), in-line with axis.

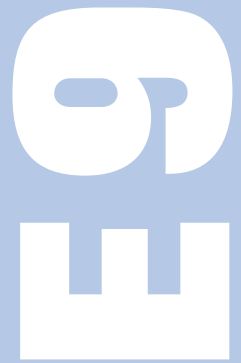

DIECAST WINDOW HANDLES

'Hi-line' style

Elegant handles suitable for most 9.5mm square-shaft drives. The packing shim 1/07995 can be used to convert to 8mm square-drive.

'Smooth-line' style

Attractive, clean-styled handles, with centre-fixing at 45° to axis. A moulded spacer disc (5/01595) is supplied as standard, and there is a choice of large or small knobs.

9/01595 (splined core model)

A special version has 'female' splined core to suit certain types of window regulators. Ask for drawing

'Low-line' style

A smaller, lower handle, which in standard version has a recessed hexagon-form to accept 'Wilmot Breeden'-style window regulators.

9/01701 (splined core model)

A special version has 'male' splined core to suit AC-Delco window regulators. Ask for drawing.



9/00874
Centre fix handle



9/00875
Concealed
fix handle

Grub screw
(2BA) supplied

ORDERING CODE

9/00874 Centre-screw handle, chrome

9/00874B Centre-screw handle, black

9/00875 Concealed-fix handle, chrome

9/00875B Concealed-fix handle, black

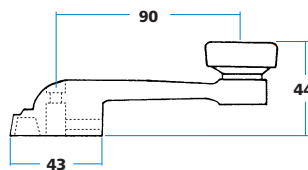

Core is 9.5mm square, in-line with axis

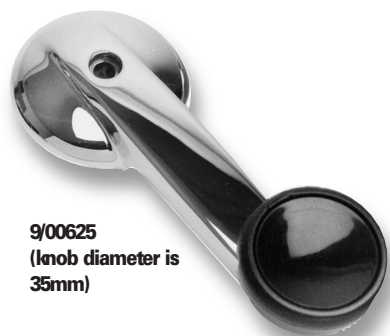

9/00625
(knob diameter is
35mm)



9/00225
(large, knurled
knob, 40mm dia.)

ORDERING CODE

9/00225 Window handle, chrome, large knob

9/00225B Window handle, black, large knob

9/00625 Window handle, chrome, small knob

9/00625B Window handle, black, small knob

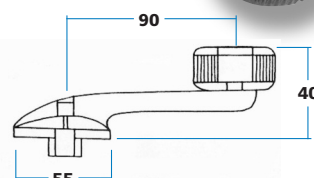

Core is 9.5mm square, at 45° to axis



1/24425
Handle with
'hexagon' form



9/01701
Handle with
'male' spline form

ORDERING CODE

1/24425 Window handle, chrome, hex

1/24425B Window handle, black, hex

9/01701 Window handle, chrome, spline

9/01701B Window handle, black, spline

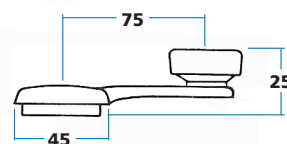

Top recess 6mm diameter x 10mm deep

7/03099

7/03098

Detailed view of 'star wheel' area.

SUPPORT STAYS 'STAR-WHEEL' RELEASE

This range of extensible stays provides a simple, inexpensive and long-lasting method of supporting top-hinged doors and hatches. The 'star-wheel' design allows automatic release - useful where two stays are fitted on a very wide panel. Many options are available.

ORDERING CODE

7/03098	Stay, 290/495 mm, 2 brackets
7/03099	Stay, 290/495 mm, bottom bracket only
9/00557	Stay, 290/495 mm, no brackets
9/00006	Stay, as 7/03099, with thumb-screw



Thumb-screw fitment

A weld-nut is fitted in the outer slide, so that the thumb-screw can be tightened, thus locking the stay at any intermediate position.

SPECIFICATION

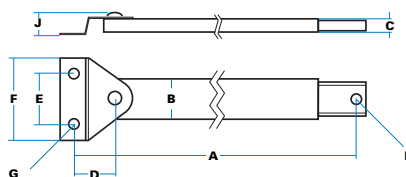

A Length between centres, closed	290 mm
extended	495 mm
B Max. Width (outer)	25 mm
C Max. Depth (outer)	12 mm
D Location (bottom)	28 mm
E Hole centres	35 mm
F Bracket width	57 mm
G Hole sizes (diameter)	9 mm
H Hole size (diameter)	6 mm
J Bracket height	14 mm

Note: Standard bracket shown is 7/03094, full dimensions on page C16



Stay extends as door is opened, and locks in the extended position. It is automatically released by a further slight extension, allowing unit to be closed.



Clear zinc-plated. To special order black zinc-plated.



Standard brackets (7/03094) as illustrated for plant-on fitting.



Mild steel throughout



7/03099 is a direct alternative to Jagger 2522/001



- Special lengths
- Alternative brackets
- Thumb-screw fitment (illustrated)
- Weld-studs on stay sections for concealed fixing

Alternative Brackets

E14

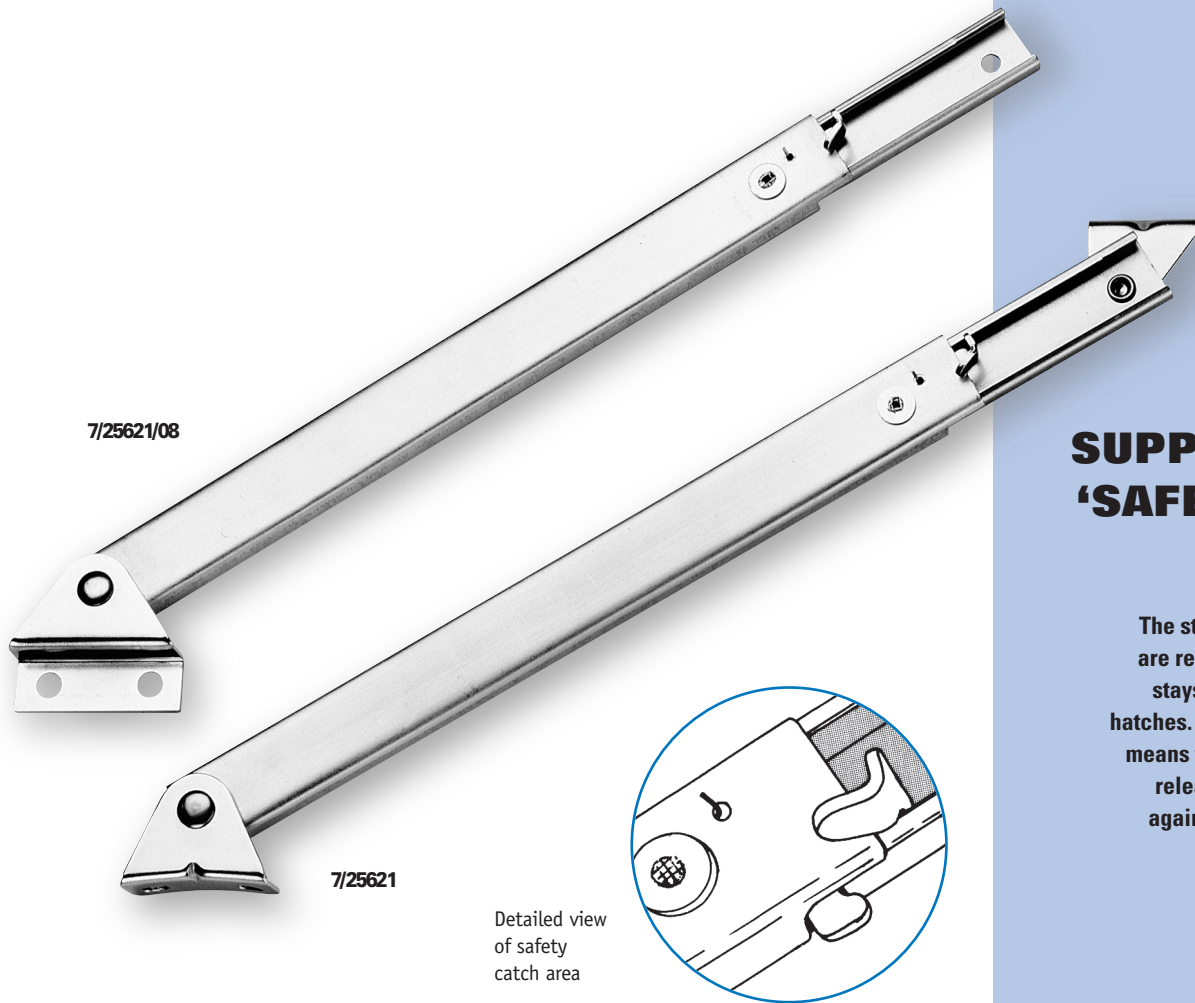
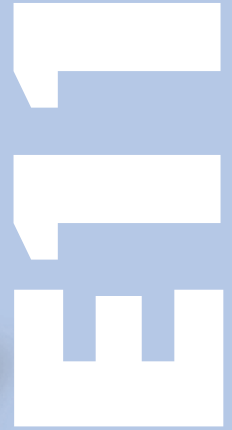

SUPPORT STAYS 'SAFETY CATCH' RELEASE

The standard models illustrated are representative of a family of stays for top-hinged doors and hatches. The 'safety-catch' design means the stay must be manually released - a useful precaution against vibration or accidental closure.

ORDERING CODE

7/25621 Stay, 285/470 mm, 2 brackets

7/25621/08 Stay, 285/470 mm, with base bracket (7/03094) special.

7/35838 Stay, 340/585 mm, no brackets

7/35838/01 Stay, 340/585 mm, with base bracket (7/03094) only.

7/35839 Stay, 210/335 mm, no brackets

7/35843 Stay, 285/425 mm, no brackets

7/35864 Stay, 340/530 mm, no brackets

Note: Standard brackets shown are 7/09514 (top) and 7/21194 (bottom). Bottom bracket has radiused base and elongated fixing holes for adjustment.

When supplied without brackets, top & bottom sections have mounting holes at 6mm diameter

SPECIFICATION

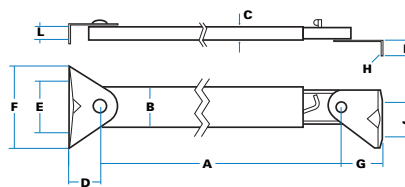

(Standard model 7/25621 shown)

A Length between centres, closed	285 mm
extended	470 mm
B Max. Width (outer)	25 mm
C Max. Depth (outer)	12 mm
D Location (bottom)	23 mm
E Hole centres (bottom)	32 mm
F Bracket width (bottom)	57 mm
G Location (top)	23 mm
H Hole sizes (diameter)	5 mm
J Hole centres (top)	19 mm
K Location (top)	9 mm
L Location (bottom)	13 mm



Stay extends as door is opened, and locks in the extended position. The safety catch must be depressed manually before it will close.



Clear zinc-plated. To special order, black zinc-plated.



Standard brackets as illustrated for plant-on fitting.



Mild steel throughout



- Special lengths (see models listed)
- Alternative brackets
- Weld-studs on stay sections for concealed fixing.

Alternative Brackets



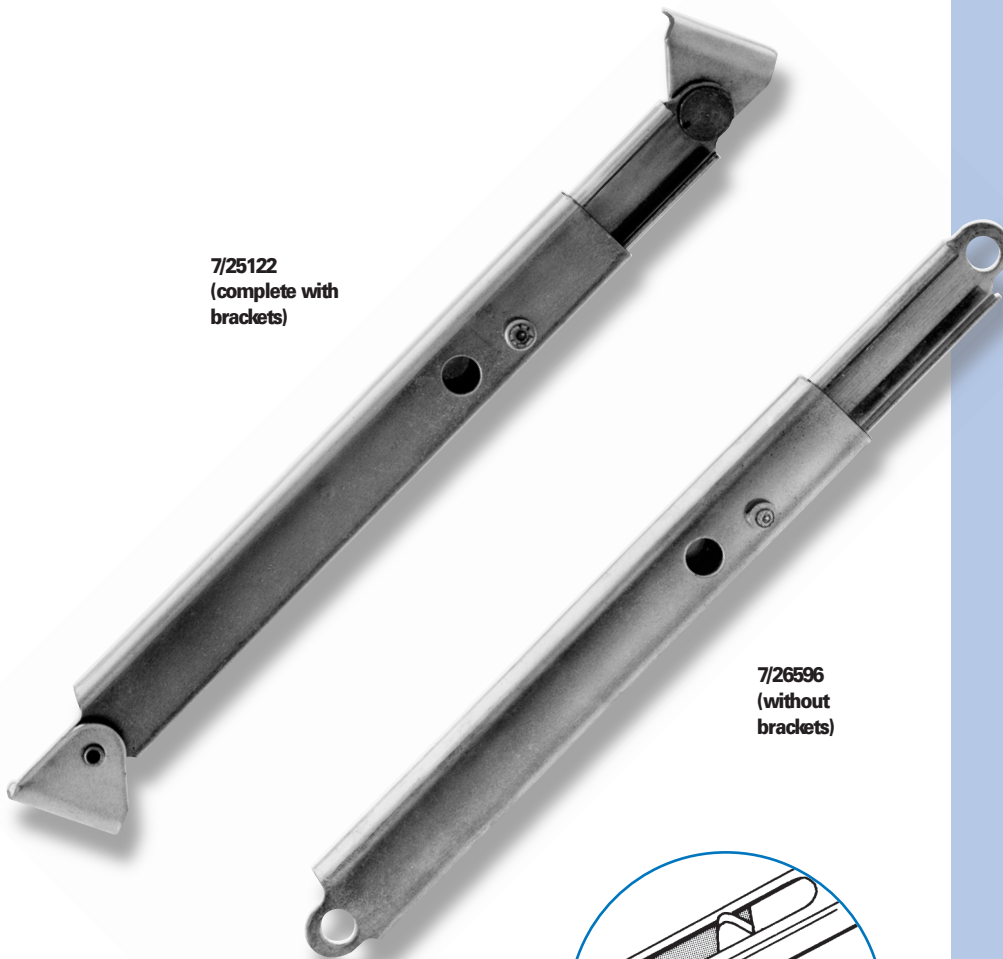

7/25122
(complete with brackets)

7/26596
(without brackets)

Detailed view of 'star wheel' area.

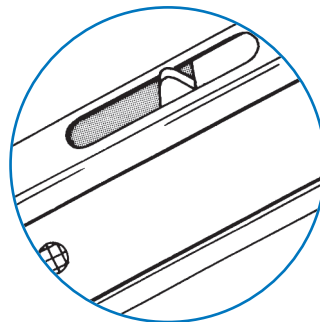

'MINIATURE' SUPPORT STAYS ['STAR-WHEEL' RELEASE]

These miniaturised versions of our standard stays use a section width of 9 mm x 19 mm, making them less obtrusive and suitable for smaller installations. The 'star-wheel' design allows automatic release - useful where two stays are fitted.

Applications include electrical cabinets, instrument cases, inspection windows and ski-boxes. Many options are available.

ORDERING CODE

7/25122	'Miniature' stay, 2 brackets
7/25122/01	'Miniature' stay, brackets reversed
7/25122/02	'Miniature' stay with thumbscrew
7/26596	'Miniature' stay, no brackets
7/26596/02	'Miniature' stay with thumbscrew



Thumb-screw fitment (7/26596/02)

A weld-nut is fitted in the outer slide, so that the thumb-screw can be tightened, thus locking the stay at any intermediate position.

SPECIFICATION

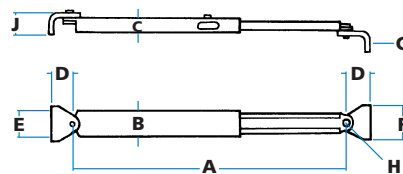

A Length between centres, closed	152 mm
extended	239 mm
B Max width (outer)	19 mm
C Max depth (outer)	9 mm
D Location	16 mm
E Hole centres	13 mm
F Bracket width	24 mm
G Hole sizes (diameter)	3.5 mm
H Hole sizes (7/26596)	dia. 10 mm
J Bracket height	13 mm

Note: Standard bracket shown is 7/25135



Stay extends as door is opened, and locks in the extended position. It is automatically released by a further slight extension, allowing unit to be closed.



Clear zinc-plated. To special order, black zinc-plated.



Standard brackets (7/25135) as illustrated for plant-on fitting.



Mild steel throughout.



- Special lengths
- Alternative brackets
- Thumb-screw fitment (illustrated)

Alternative Brackets



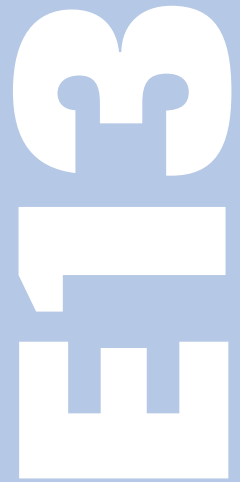

7/03094

Standard bracket with stay 7/03098-9, with double-raised base. Symmetrical. Material: 1.6 mm mild steel, bright zinc-plated. Base mounting holes 8 mm dia.

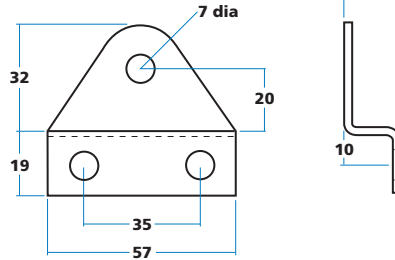

9/00628

Symmetrical bracket, narrow base and strengthening rib and inclined face. Material: 1.6 mm mild steel, bright zinc-plated. Base mounting holes 5.5 mm dia

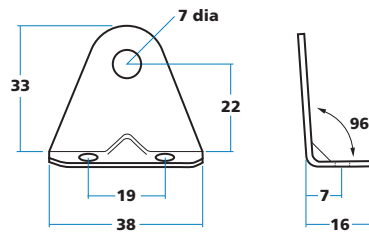

7/35598

Asymmetric bracket with wide base and elongated holes, with strengthening rib and inclined face. Material: 1.6 mm mild steel, bright zinc-plated. Base mounting holes 6 x 9 mm elongated.

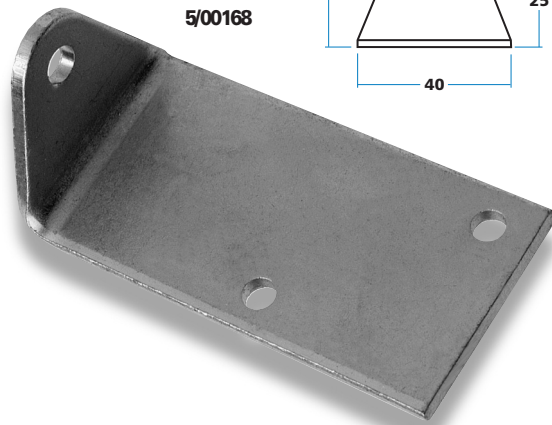
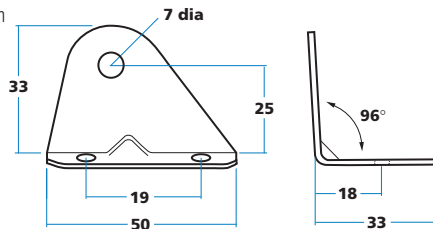

5/00168

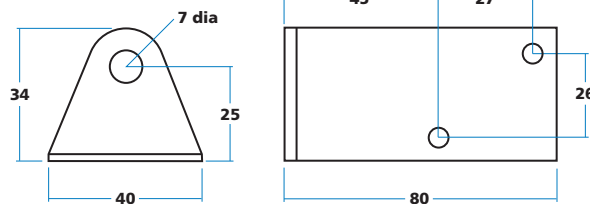

Large bracket to spread load over wider area, acting as a structural member. Material: 3 mm mild steel, bright zinc-plated. Base mounting holes 5.5 mm dia.

ALTERNATIVE BRACKETS - SUPPORT STAYS

These brackets can be fitted as alternatives to any of our support stays with 12 mm x 25 mm section, either to the outer face of the section (as normal) or reversed. Special brackets can be created where volume production is involved.

HINGES

**SPECIALITY
HINGES IN
STAINLESS
STEEL, DIECAST
& MOULDED
MATERIALS**

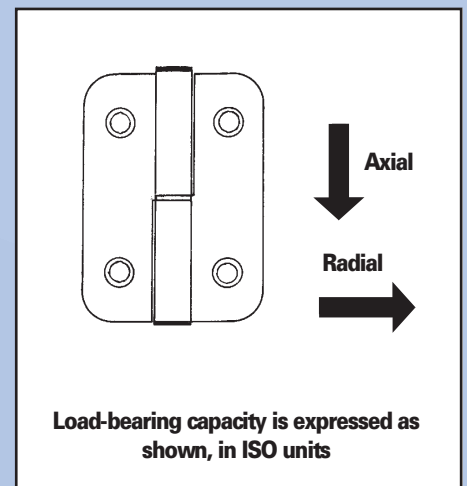

These are not simple, domestic-door hinges! Instead, WBH offers a number of speciality designs for particular requirements. These include 'lift-off' models for industrial enclosures, plus several types of hinge for boot, bonnet and windows in automotive applications.

Stainless hinges are polished to mirror-finish. Concealed-fix models are attractive and give added protection against theft and vandalism.



New, diecast 'block' hinges suit flush-fitting doors



Above: Stainless steel hinge, countersunk fixing holes and polished to a mirror-finish for high-quality enclosures



LIFT-OFF MOULDED HINGES

Large size, with
integral dust seal

These hinges have been designed for corrosion resistance, and to prevent stiffness and uneven action, common problems on construction sites and other 'dirty' environments. They are made from self-colour composite material, with a stainless pin 'buried' within the hinge and fitted with an 'O'-ring to stop dirt and debris from entering. Left-hand & right-hand versions.

ORDERING CODE

- 9/04442** Lift-off hinge, RH
9/04443 Lift-off hinge, LH

SPECIFICATION

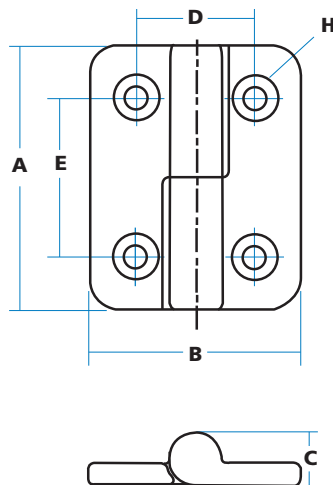





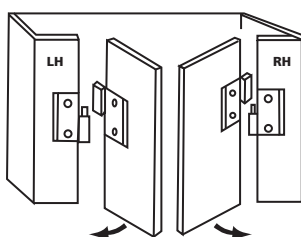

A Length	100 mm
B Width (total)	80 mm
C Height (max)	20 mm
D Location, (width)	45 mm
E Location (height)	60 mm
H Hole sizes (dia.)	8.5mm, c/s mm 18 mm

Leaf thickness 8.5mm, pin diameter 10mm.

Explanation of 'handing'



(two hinges should be fitted to each door)

-  Moulded for strength and good appearance, large-diameter stainless steel pin for easy assembly, with 'O'-ring fitted as shown.
-  Door lifts-off from fixed pin in bottom half of hinge. Oppose LH & RH if door is required to be permanently fixed.
-  Hinges open fully forward to 180°, backward to 110° from vertical.
-  Plant-on, and secured through countersunk holes in hinge leaf.
-  Black, self-coloured with fine-textured finish.
-  Moulded in 30% glass-filled, UV-stabilised nylon.
-  Axial loading: 10.87 kN (max advised)
Radial loading: 2.42 kN (max advised)
Endurance testing: 60,000 cycles (rig-tested to withstand salt/spray & debris injection)

9/01443
LH illustrated



LIFT-OFF STEEL HINGES

These steel hinges carry relatively high loads and are suitable for larger enclosures such as compressors, generators and electrical cabinets. They are available in either mild steel or stainless steel, with end caps and stainless pin and bearing washer for smooth operation and corrosion resistance. Left-hand and right-hand available.

Interchangeable with our moulded & diecast lift-off models

! Excellent surface finish (stainless models are mirror-polished), 3 mm material thickness and large-diameter stainless pin for easy assembly.

! Plant-on, and secured through countersunk holes in hinge leaf.

! Stainless steel models are mirror-polished. Mild steel models are yellow zinc-plated or black powder-coated.

M Stainless steel models in Grade 304, mild steel models in CR4, with stainless pin and washer and black moulded end-caps.

T **Stainless models**
Axial loading
Maximum advised: 46.46kN
Ultimate: 69.69kN

Radial loading
Maximum advised: 7.70kN
Ultimate: 11.60kN

Mild steel models
Axial loading
Maximum advised: 26.60kN
Ultimate: 39.90kN

Radial loading
Maximum advised: 5.86kN
Ultimate: 8.79kN

ORDERING CODE

9/01442 Stainless lift-off hinge, RH

9/01443 Stainless lift-off hinge, LH

9/01402 Steel lift-off hinge, RH, zinc

9/01403 Steel lift-off hinge, LH, zinc

9/01536 Steel lift-off hinge, RH, black

9/01535 Steel lift-off hinge, LH, black

SPECIFICATION

Right hand illustrated

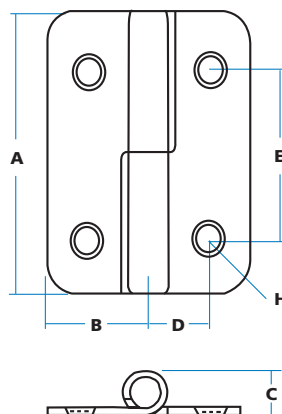

A Length	100 mm
B Width (half)	37 mm
C Height	15 mm
D Location to axis	22.5 mm
E Hole centres	60 mm
H Hole sizes (diameter)	10 mm, c/s 15 mm

Material thickness 3 mm, pin diameter 10 mm

Explanation of 'handing'

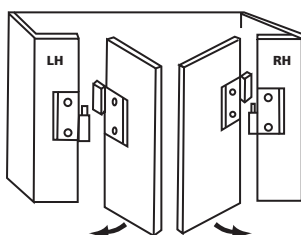

(two hinges should be fitted to each door)

Angle of opening
Hinges will open fully forward to 180°, backward to 90° from horizontal

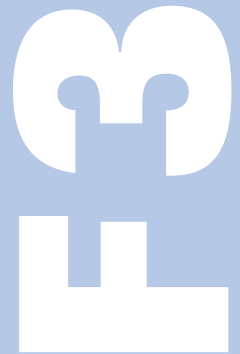
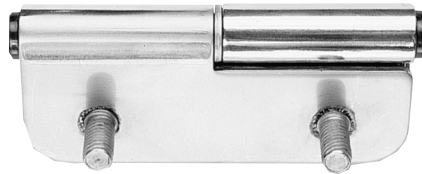

Illustration shows welded studs for concealed fixing.



9/01445 (LH)

9/01444 (RH)

LIFT-OFF CONCEALED-FIX STEEL HINGES

In this design fixing holes are omitted and are replaced with welded-on M8 threaded studs.

This provides an attractive, smooth, and tamper-proof visible surface, in either mirror-polished stainless steel or mild steel, black powder-coated. Left-hand and right-hand available.

! Excellent surface finish, 3 mm material thickness and large-diameter stainless pin for easy assembly.

M Fixing by two threaded studs, 15mm x M8 on each leaf.

T **Stainless models**
Axial loading
Maximum advised: 8.00kN
Ultimate: 12.10kN

Radial loading
Maximum advised: 4.10kN
Ultimate: 6.10kN

Mild Steel models
Axial loading
Maximum advised: 14.60kN
Ultimate: 22.00kN

Radial loading
Maximum advised: 3.70kN
Ultimate: 5.60kN

LIFT-OFF ADJUSTABLE STEEL HINGES

These hinges have elongated fixing holes as shown, to allow adjustment when bringing door to meet frame. All other dimensions and results as shown opposite. Stainless steel models only.

ORDERING CODE

- 9/01444 Stainless concealed hinge, RH
- 9/01445 Stainless concealed hinge, LH
- 9/01539 Steel concealed hinge, RH, black
- 9/01538 Steel concealed hinge, LH, black

Dimensions and fixing centres shown opposite

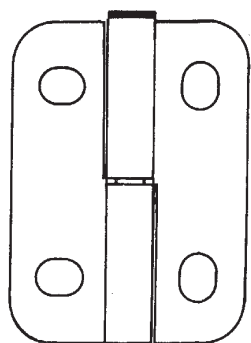

9/01400 (LH)

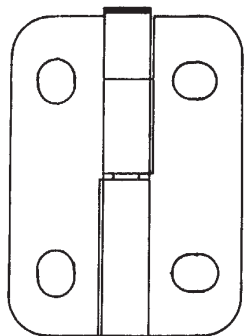

9/01401 (RH)

4 slots, positioned as shown, 11 mm wide x 14 mm long



9/01400 (LH) illustrated

ORDERING CODE

- 9/01400 Stainless adjustable hinge, LH
- 9/01401 Stainless adjustable hinge, RH

9/01824
RH illustrated



9/01825 (LH)

9/01824 (RH)

ORDERING CODE

9/01824 Concealed fix hinge, RH, black

9/01825 Concealed-fix hinge, LH, black

SPECIFICATION

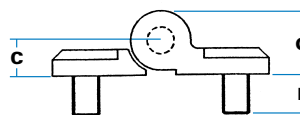
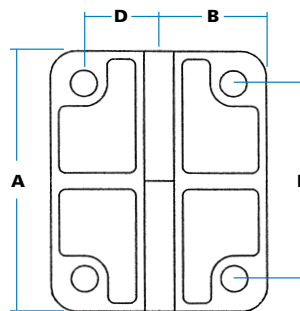

A Length	80 mm
B Width (half)	32.5 mm
C Height to pin	10.5 mm
D Location to axis	22.5 mm
E Mounting centres	60 mm
F Stud dimensions	M8 x 15 mm
G Height	19.5 mm

Pin diameter 8 mm, projecting 25 mm above face of lower hinge section.

Explanation of 'handing'

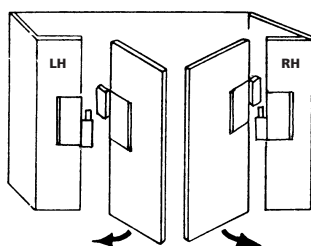

(two hinges should be fitted to each door)

Angle of opening

Hinges will open fully forward to 180°, backward to 45° from horizontal.

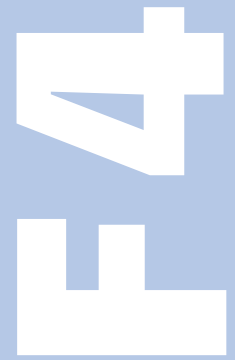

LIFT-OFF CONCEALED-FIX DIECAST HINGES - BLACK OR CHROMIUM PLATED

Lift-off hinges providing improved appearance and greater security by use of concealed fixing studs, secured from inside. These are robust hinges intended for large enclosure doors, interior or exterior use. Left-hand and right-hand.

Interchangeable with our moulded & diecast lift-off models



Doors lift-off fixed pin in bottom half of hinge. Use LH and RH together (opposed) when door is required to be permanently fixed.



Fixing by two threaded studs M8 x 12 mm, cast-in each leaf.



Black powder-coated finish.



Zinc alloy diecast, with 8 mm stainless steel pin.



Stainless models

Axial loading
Maximum advised: 15.36kN
Ultimate: 23.04kN

Radial loading
Maximum advised: 6.94kN
Ultimate: 10.41kN



Highly competitive against market alternatives.

Stainless
Models





9/01381
LH illustrated









9/01381 (LH)

9/01380 (RH)

LIFT-OFF MOULDED HINGES (SMALLER SIZE)

Developed as an alternative to our popular diecast 'torpedo' hinges, this smart design brings all the advantages of modern materials, yet is more economical and fully interchangeable with the diecast models. Left-hand and right-hand available.

Interchangeable with our diecast 'torpedo' hinges

-  Totally corrosion-resistant, for indoor/outdoor use, textured, self-colour finish, and self-lubricating - will not seize up or bind.
-  Doors lift-off fixed pin in bottom half of hinge. Use LH and RH together (opposed) when door is required to be permanently fixed.
-  Plant-on, and secured through countersunk holes in hinge leaf.
-  Black, with matt textured finish.
-  Hinges moulded in 15% glass-filled nylon, with 10 mm diameter pin in Grade 303 stainless steel, ultrasonically welded into lower half.
-  **Stainless models**
Axial loading
Maximum advised: 2.63kN
Ultimate: 3.95kN

Radial loading
Maximum advised: 0.76kN
Ultimate: 1.15kN
-  Highly competitive against market alternatives.

ORDERING CODE

9/01380 Lift-off moulded hinge, RH

9/01381 Lift-off moulded hinge, LH

Explanation of 'handing'

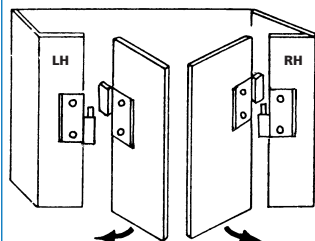

(two hinges should be fitted to each door)

Angle of opening

Hinges will open fully forward to 180°, backward to 45° from horizontal.

SPECIFICATION

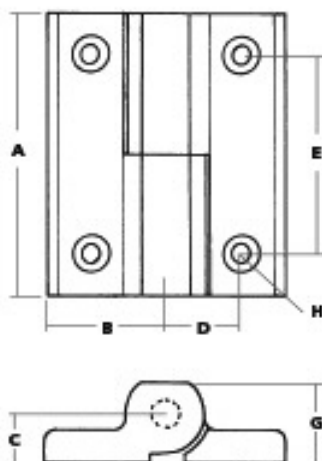

A Length	74 mm
B Width (half)	30 mm
C Height to pin	12 mm
D Location to axis	18 mm
E Hole centres	51 mm
G Height	20 mm
H Hole sizes	(diameter) 5 mm, c/s 9 mm

'Torpedo' hinges

F6

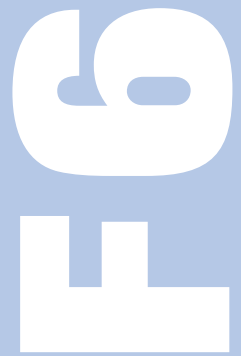

7/10016
LH illustrated

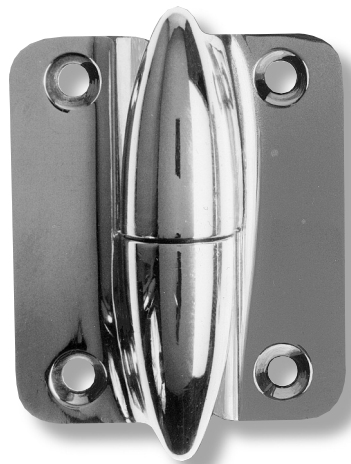

7/10016 (LH)



7/10015 (RH)

ORDERING CODE

7/10015 Lift-off hinge, RH, chrome

7/10016 Lift-off hinge, LH, chrome

1/26809 Lift-off hinge, RH, raw

1/26808 Lift-off hinge, LH, raw

Add suffix 'B' for black finish

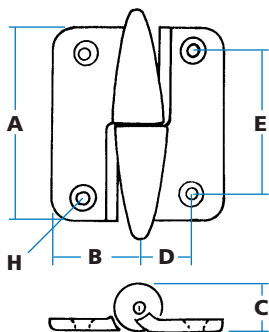

SPECIFICATION

A Length (max)	76 mm
B Width (half)	30 mm
C Height	18 mm
D Location to axis	18 mm
E Hole centres	51 mm
H Hole sizes (diameter)	5 mm, c/s 9 mm

Angle of opening

Hinges will open fully forward to 180°, backward to 60° from horizontal



Doors lift-off fixed pin in bottom half of hinge. Use LH and RH together (opposed) when door is required to be permanently fixed.



Plant-on, and secured through countersunk holes in hinge leaf.



Bright chromium-plated or raw finish (for painting). Black to special order.



Zinc alloy diecast, with stainless steel pin.



Rig-tests show that two hinges (on a 1-metre frame) carried a load of 60kg. (130lb) without damage, equivalent to a moment of force of 60NM (3.43KN).

SPECIFICATION

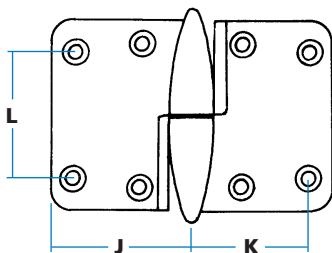

J Width (half)	48 mm
K Location to axis	42 mm
L Hole centres	44 mm
All other dimensions as 2-hole models	



7/04131 (LH)

ORDERING CODE

7/04132 4-hole hinge, RH, chrome

7/04131 4-hole hinge, LH, chrome

4-HOLE 'TORPEDO' HINGES

These 4-hole versions are recommended for heavier doors where the extended leaf enables weight to be better distributed. Left-hand and right-hand available.



Rig-tests show that two 4-hole hinges carried a load of 125kg (275lb) without damage, equivalent to a moment of force of 125NM (7.34KN).

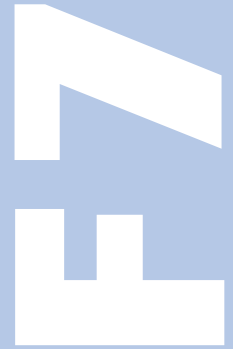

DIECAST WINDOW/HATCH 'FLAT' HINGE

A low-profile design with concealed fixing on the leaf into two tapped bosses. These, with securing plate and rubber gaskets, allow a panel to be held securely without damage or fracture. Ideal for top-hinged windows and hatches.



9/00699
Black



9/00700
Chromium-plated

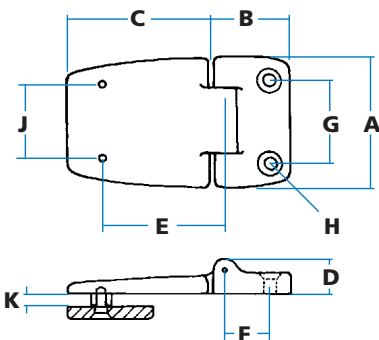

SPECIFICATION

A Width (max)	62 mm
B Length (butt)	36 mm
C Length (leaf)	70 mm
D Height (max)	18 mm
E Location to pivot	60 mm
F Location to pivot	23 mm
G Hole centres	43 mm
H Hole sizes (diameter)	6 mm c/s 12 mm
J Hole centres	38 mm
K Aperture for panel	6 mm (optimum)
Angle of opening	160° forwards



Window glass or hatch panel is clamped between hinge leaf and securing plate.



Hinge 'butt' is plant-on fitting through two countersunk holes.



Black powder coated or chromium plated. coloured finishes on request.



Zinc diecast, with stainless steel pin and rubber gaskets and nylon spacers on leaf/securing plate.



Axial Loading
Maximum advised: 2.86KN
Ultimate: 4.30KN

Radial Loading
Maximum advised: 2.80KN
Ultimate: 4.20KN

ORDERING CODE

9/00699 'Flat' hinge, black

9/00700 'Flat' hinge, chromium plated



9/00034

ORDERING CODE

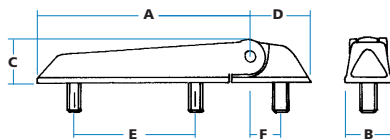

9/00034 Boot/bonnet hinge, chrome

9/00634 Boot/bonnet hinge, black

SPECIFICATION

A Leaf length	135 mm
B Width (max)	22 mm
C Height	19 mm
D Length (butt)	30 mm
E Hole centres	58 mm
F Location	15 mm

Stud sizes

Butt end, 15 mm x 5/16" UNF

Leaf end, 15 mm x 1/4" UNF (2)



Hinge opens fully to 90°



Hinge is plant-on, with three threaded studs on bottom face.



Chromium-plated or black powder-coated.



Zinc diecast, with steel hinge-pin and studs, zinc-plated for corrosion resistance.

Pin is driven fully-flush when assembled.



9/00048

SPECIFICATION

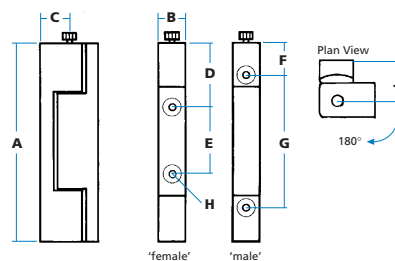

A Length	100 mm
B Width	15 mm
C Height to pin	15 mm
D Location	35 mm
E Hole centres	32 mm
F Location	16 mm
G Hole centres	64 mm
H Hole sizes	(dia) 5 mm c/s 9 mm
J Height to hole	15 mm

INVISIBLE - FIXING 'FRENCH' HINGES

An alternative to lift-off "block" hinges, this design allows door and frame to be assembled separately, then brought together and retained by inserting the 6 mm knurled pin. Fixing holes are completely hidden and movement is through 180°. Finish is chromium-plated with stainless steel pin.

ORDERING CODE

9/00048 'French' hinge, chromium-plated



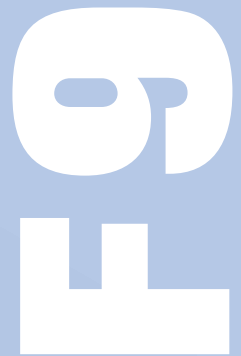

RAISED-PROFILE HINGES

in stainless steel

In this design the hinge pin is raised above the surface to allow clear opening of doors. The hinge leaf is shaped accordingly, giving additional strength and good appearance. 'Handed' only by direction of fitted pin, and available in two sizes as shown.

ORDERING CODE

9/01780	Stainless profile hinge, 120 mm, RH
9/01781	Stainless profile hinge, 120 mm, LH
9/01782	Stainless profile hinge, 80 mm, RH
9/01783	Stainless profile hinge, 80 mm, LH

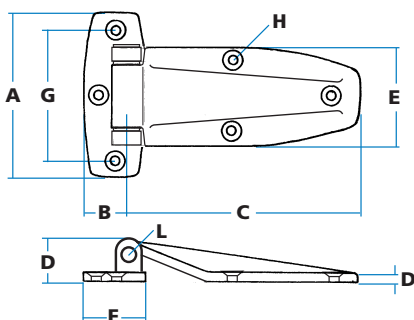

SPECIFICATION

	80mm	120mm
A Width	64 mm	82 mm
B location	20 mm	25 mm
C Length	80 mm	120 mm
D Height	15 mm	20 mm
E Max. Width	40 mm	50 mm
F Base centres	28 mm	32 mm
G Location	52 mm	64 mm
H Hole sizes(dia)	4 mm	6 mm
J Location	9 mm	12 mm
K Thickness	2.5 mm	4.0 mm
L Pin diameter	6 mm	8 mm

Note: Headed pin is shown fitted in right hand position: this is removable and can be reversed on site



Hinges open fully forward to 180°



Plant-on, and secured through countersunk holes in leaf butt. Hinge pin is removable.



Bright polished.



Stainless steel in Grade 304 with stainless pin and bearing washers.

ORDERING CODE

9/00701	Diecast profile hinge, 120 mm
----------------	-------------------------------

less expensive than stainless models, the diecast hinge is ideal for interior and less-demanding applications



DIECAST RAISED-PROFILE HINGES

A similar model to the 120mm hinge, but made in zinc diecast alloy and chromium-plated for good appearance. Also available with black powder-coated finish.



9/01542

OLE

FIXED -PIN VERTICAL LEAF HINGES

An attractive and useful hinge for large enclosures where door frame width is restricted, but where relatively heavy loading is anticipated. This is a fixed-pin hinge and it is non-handed.

ORDERING CODE

9/01542 Vertical hinge, stainless steel

Concealed-fixing option
with welded studs



To special order, hinges can be supplied with M8 threaded studs, welded to underside of hinge leaf in same position as normal holes.

SPECIFICATION

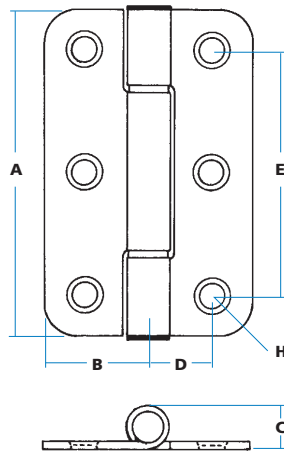

A Length	130 mm
B Width(half)	40 mm
C Height	15 mm
D Location to axis	22.5 mm
E Hole centres	94 mm
F Hole sizes (diameter)	10mm, c/s 15 min

Material thickness 3 mm, pin diameter 10mm

Angle of opening

Hinges will open fully forward to 180° , backward to 90° from horizontal

! Mirror-polished stainless steel in 3 mm material thickness, with end caps and large-diameter stainless pin and bearing washers for smooth movement and corrosion resistance.

M Plant -on, and secured through countersunk holes in hinge leaf.

P Mirror-polished

M Stainless steel in Grade 304 with stainless pin and washers and black moulded end-caps.

? - Weld-on studs
- Mild steel model to special order.

T Axial Loading
Maximum advised: 31.80kN
Ultimate: 47.70kN

Radial Loading
Maximum advised: 10.53kN
Ultimate: 15.80kN



9/01967
Left-side hinge



DIECAST 'BLOCK' HINGES FOR FLUSH DOORS

These 'block' hinges are a simple way to hang flush doors on metal cabinets, electrical enclosures, etc, allowing "lift-off" capability from a narrow door surround.

'Handed', left- and right -, these hinges provide great flexibility in a variety of configurations. See schemes below. Use one hinge of each hand to create a non-lift-off, permanently retained door

ORDERING CODE

9/01966	Hinge, RH, chrome
9/01966B	Hinge, RH, black
9/01966R	Hinge, RH, raw
9/01967	Hinge, LH, chrome
9/01967B	Hinge, LH, black
9/01967R	Hinge, LH, raw

SPECIFICATION

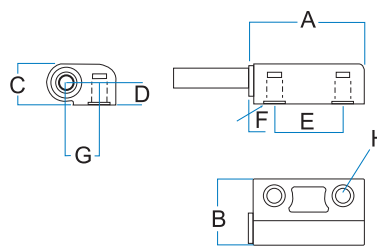

A Length (half)	43 mm
B Width	25.5 mm
C Height	15 mm
D Height to pin	8.5 mm
E Location	25.5 mm
F Location	9.5 mm
G Location	12.7 mm
H Hole sizes	M6x9 mm

Note: Hinge pin diameter 6 mm, projection 25 mm.

Door Fixing Modes

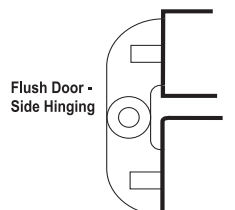
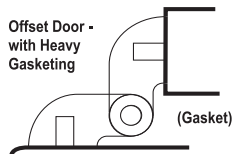
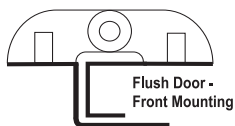

Bottom half of hinge contains a fixed, stainless steel pin, and is fitted to door frame. Top half is fitted to face of door and is lifted on (and off) pin. Movement is completely free.

Plant-on fitting, with two holes in base of each portion, tapped for M6 bolts.

Chromium-plated, black powder-coated or raw metal for painting after assembly.

M Zinc diecast, with stainless steel pin.

A Interchangeable with Southco offset knuckle '400' series.

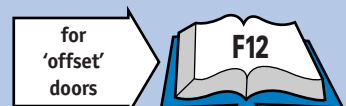

Hole & peg design



60mm length
1/26380

35mm length
1/26392

Two-hole design

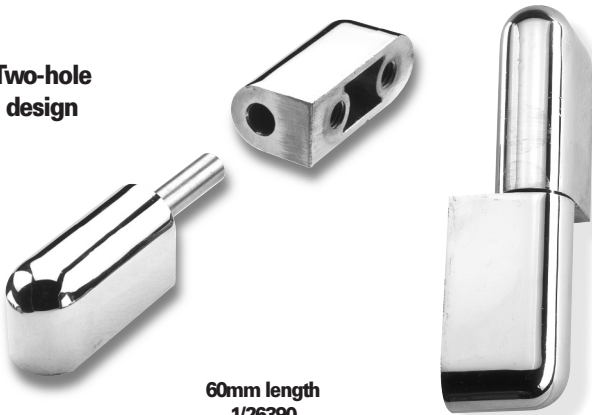

60mm length
1/26390

**DIECAST
'BLOCK' HINGES
FOR OFFSET
DOORS**

Small & 'Mini' sizes

'Block' hinges are a neat, convenient method for hanging externally-fixed doors on metal cabinets, electrical enclosures, etc. Non-handed, the upper part simply sits onto a fixed steel pin. (Oppose hinges for when door is permanently fitted).

These two smaller sizes have a 'peg' for location purposes. A stainless steel pin is optional.

ORDERING CODE

'Mini' (35 mm) hinges (hole and peg)

1/26391	raw finish
1/26392	chrome finish
1/26393	black finish

'Small' (60 mm) hinges (hole and peg)

1/26379	raw finish
1/26379B	black finish
1/26380	chrome finish

Two-hole design (60mm only)

With this option the 'peg' is replaced by a second tapped hole at the same location.

'Small' (60 mm) hinges (2 holes)

1/26389	raw finish
1/26389B	black finish
1/26390	chrome finish

Note: Add 'SS' to order code to specify stainless pin on 35 mm and 60 mm models.

SPECIFICATION

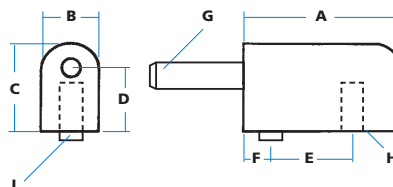

Hole-and-peg models

	35 mm hinge	60 mm hinge
A Length (half)	17.5 mm	30 mm
B Width	13 mm	13 mm
C Height	14 mm	14 mm
D Height to pin	7.5 mm	7.5 mm
E Location	7.5 mm	16 mm
F Location	5 mm	8 mm
G Pin diameter	6 mm	6 mm
H Hole size	6 mm x M5	6 mm x M5
J Peg size	2 x 3 mm dia	3 x 6 mm dia

Bottom half of hinge contains a fixed steel pin and is fitted to door frame. Top half is fitted to door edge and is lifted on (and off) pin. Movement is completely free.

Chromium-plated, black powder-coated or raw metal for painting after assembly.

Plant-on fitting. Tapped hole (M5 x 6mm) and location peg. (Two holes optional on 60mm size)

Zinc diecast, with mild steel pin, zinc-plated. Stainless pin is optional.

Stainless
'Block'
hinges



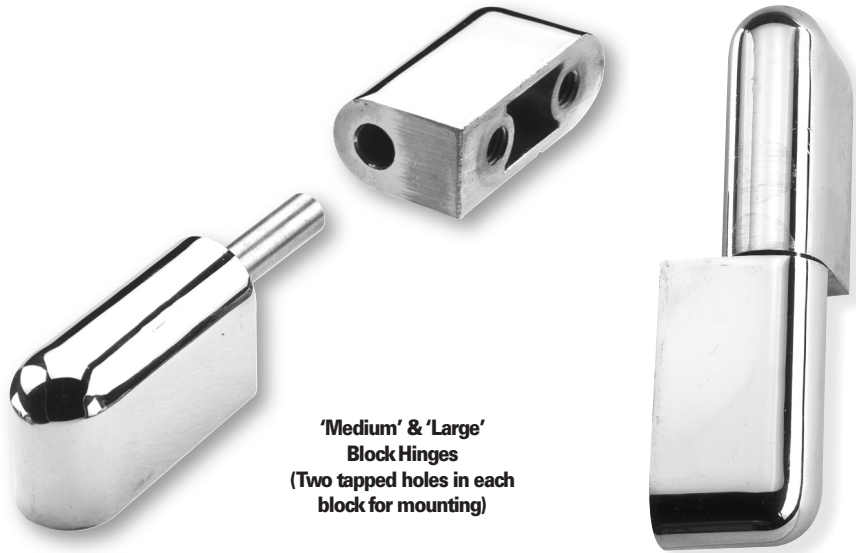

**'Medium' & 'Large'
Block Hinges**
(Two tapped holes in each
block for mounting)

DIECAST 'BLOCK' HINGES FOR OFFSET DOORS

Medium & Large sizes

'Block' hinges are a neat, convenient method for hanging externally-fixed doors on metal cabinets, electrical enclosures, etc. Non-handed, the upper part simply sits onto a fixed steel pin. (Oppose hinges for when door is permanently fitted).

ORDERING CODE

'Medium' (76 mm) hinges (2 holes)	
1/26750	raw finish
1/26915	chrome finish
1/26915B	black finish

'Large' (100 mm) hinges (2 holes)	
9/00838	raw finish
9/00839	chrome finish
9/00840	black finish

Note: Add 'SS' to order code to specify stainless pin on 76 mm models.

SPECIFICATION

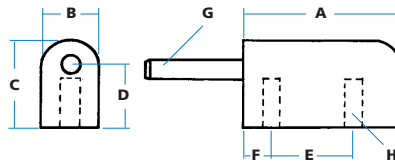

'Medium' (76mm) hinges

A Length (half)	38 mm
B Width	17 mm
C Height	19 mm
D Height to pin	11 mm
E Location	19 mm
F Location	9 mm
G Pin diameter	6 mm
H Hole size	M6 x 7.5 mm

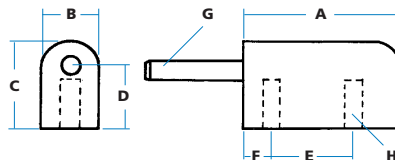

'Large' (100mm) hinges

A Length (half)	50 mm
B Width	19 mm
C Height	28 mm
D Height to pin	19 mm
E Location	25 mm
F Location	13 mm
G Pin diameter	8 mm
H Hole size	M8 x 13 mm

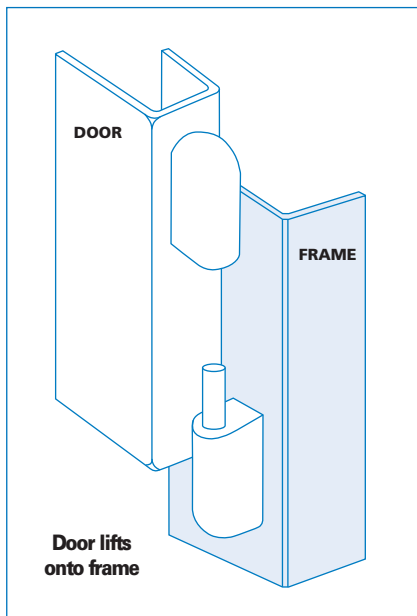

Bottom half of hinge contains a fixed steel pin and is fitted to door frame. Top half is fitted to door edge and is lifted on (and off) pin. Movement is completely free.



Chromium-plated, black powder-coated or raw metal for painting after assembly.



Plant-on fitting, with two tapped holes in each half.



Zinc diecast, with mild steel pin, zinc-plated on 76mm models. Stainless pin as standard on 100 mm Models.



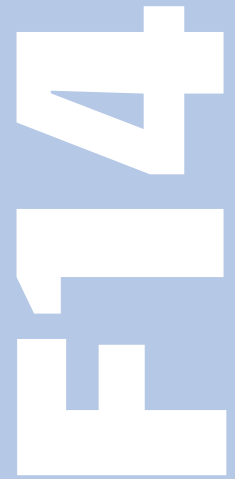

Large
(100 mm hinge)

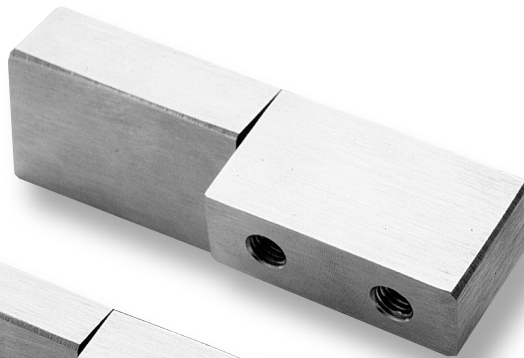

Medium
(76 mm hinge)



Small
(60 mm hinge)

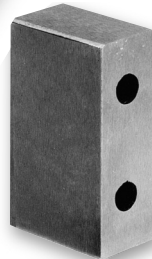
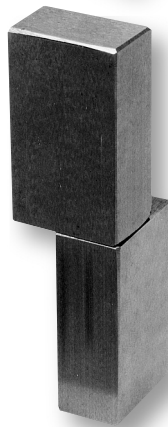
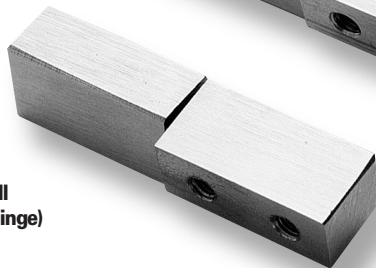

STAINLESS 'BLOCK' HINGES FOR OFFSET DOORS

These machined block hinges suit high-quality cabinets and enclosures, where stainless steel fittings are required to prevent problems with corrosion, staining and binding-up, which can occur in damp or chemically-active environments.

Produced in three standard sizes, the hinges have a ground satin finish and are lubricated with light oil for smooth action. They are exact alternatives to our diecast 'block' hinges

ORDERING CODE

9/01289	Stainless block hinge, 60 mm
9/01290	Stainless block hinge, 76 mm
9/01291	Stainless block hinge, 100 mm

SPECIFICATION

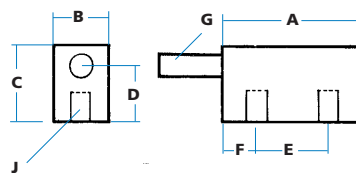

All corners have a radius and edges are chamfered.

	60 mm	76 mm	100 mm
A Length (half)	32 mm	38 mm	50 mm
B Width	13 mm	13 mm	18 mm
C Height	16 mm	19 mm	29 mm
D Height to pin	9.5 mm	13 mm	20 mm
E Location	16 mm	19 mm	25 mm
F Location	8 mm	9 mm	13 mm
G Pin diameter	6 mm	6 mm	8 mm
H Hole sizes	6 mm x M5	7.5 mm x M6	13 mm x M8

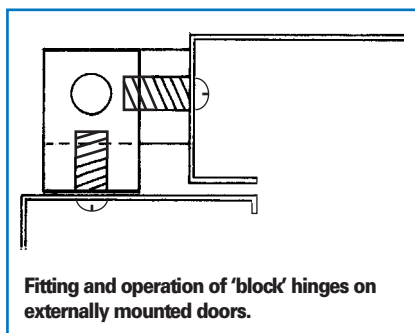

Fitting and operation of 'block' hinges on externally mounted doors.



Bottom half of hinge contains a fixed stainless pin and is fitted to door frame. Top half is fitted to door edge and is lifted on (and off) pin. Movement is completely free.



Ground, satin finish with chamfered edges. Bright-polished to special order.



Plant-on fitting, with tapped holes in base.



Stainless steel to Grade 303 throughout.



Special lengths using standard 'block' dimensions

GRABS

**'FOAMED' GRAB
RAILS, PLANT-ON
& RECESS-
FITTING GRAB
HANDLES, AND
'TRIM' ITEMS**

**NEW
PRODUCT**



Above: This 'handhold' is just one of our attractive 'foamed' products, moulded around a strong steel core.

By investing heavily in specialised tooling, WBH has created an attractive family of grab rails and handles to meet special customer needs. The 'foamed' products are steel-cored for great strength, and can be supplied in a variety of colours.

Other inside 'trim' items such as ashtrays, coat-hooks and drink-holders are useful additions to this range.



9/01725
Grab rail

'FOAMED' STEEL-CORED GRAB RAIL 300mm

Moulded in expanded polyurethane foam, this handle has a soft, resilient surface and no sharp edges, while the steel core provides strength and rigidity. This modern design replaces traditional steel stanchion rails, and ensures safety and comfort when used as a grab, or entry-assist rail.

! Soft, padded surface. No sharp edges, for maximum safety. Triangular section for good grip. Mounting holes concealed by 'snap-in' plugs.

🔧 Attractive, textured finish. Standard colours are black, red and yellow. Other colours can be moulded subject to batch-quantity requirements.

🔩 Fixing by bolting through four holes in steel core. Handle cannot be 'flexed'.

M Moulded in expanded polyurethane foam around solid, 10mm steel rod. Meets EC 95/28/CE regulations for combustibility (less than 100mm per minute)

A This handle is a direct alternative to Happich 930 0000

T **LOAD TESTING:** Tests carried out by an independent proof house gave following results: **Parallel to fixing**, load 3.70 Kilo-Newtons (377Kg) before distortion. **Vertical to fixing**, load 3.56 Kilo-Newtons (363Kg) before distortion. With ultimate strength over 1 tonne we recommend a safe working load of 250Kg (550lbs) max.

ORDERING CODE

9/01725	300mm grab rail-black
9/01725/01	300mm grab rail-red to RAL3020
9/01725/02	300mm grab rail, blue/grey
9/01725/03	300mm grab rail, yellow, RAL 1021

SPECIFICATION

A	Body Length	300 mm
B	Body Width	102 mm
C	Body Height	75 mm
D	Hole centres	165 mm
E	Hole centres	213 mm
F	Cross section	25 mm
H	Hole sizes (core)	7 mm
		10 mm steel reinforcement core

Plug diameter 15 mm accepting bolts to 12 mm head diameter x 7 mm shank.
Plug ref. 5/00538 (specify colour)

NOTE: Rigid steel core means that handle cannot be 'flexed' to accommodate deviations in fixing holes

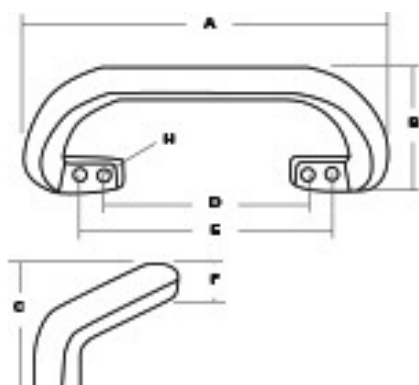



9/01226
Grab Rail

**'FOAMED'
STEEL-CORED
GRAB RAIL
475mm**

This model meets the requirement for an entry-assist rail with extended length of grip for use with entry steps on buses and coaches, or for high cabs and trucks. It is made in solid 10mm steel rod to achieve maximum strength without 'flexing'.

! Soft, padded surface. No sharp edges, for maximum safety. Triangular section for good grip. Mounting holes concealed by 'snap-in' plugs.

🔧 Attractive, textured finish. Standard colours are black red and yellow. Other colours on request.

🔩 Fixing by bolting through holes in steel core. Handle cannot be 'flexed'.

M Moulded in expanded polyurethane foam around solid, 10mm steel rod. Meets EC 95/28/CE regulation for combustibility (less than 100mm per minute).

A This handle is a direct alternative to Happich 930 0001

T **LOAD TESTING:** Tests carried out by an independent proof house gave following results: **Parallel to fixing**, load 3.47 Kilo-Newtons (353Kg) before distortion. **Vertical to fixing**, load 3.45 Kilo-Newtons (352Kg) before distortion. With Ultimate strength over 1 tonne we recommend a safe working load of 250Kg (550lbs) max.

ORDERING CODE

9/01226 475mm grab rail, black

9/01226/01 475mm grab rail, red, RAL 3020

9/01226/03 475mm grab rail, yellow, RAL 1021

SPECIFICATION

A Body Length	475 mm
B Body Width	90 mm
C Body Height	75 mm
D Hole centres	327 mm
E Hole centres	375 mm
F Cross section	33 mm
H Hole sizes (core)	7 mm
	10 mm steel rod reinforcement core

Plug diameter 15 mm accepting bolts to 12 mm head diameter x 7 mm shank.
Plug ref. 5/00538 (specify colour)

NOTE: Rigid steel core means that handle cannot be 'flexed' to accommodate deviations in fixing holes.

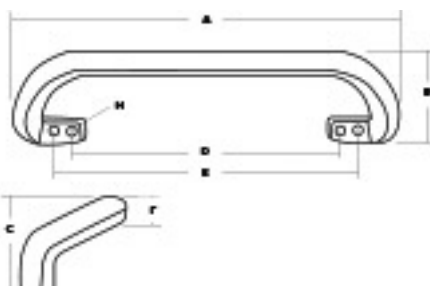



9/01228
Hand-hold in 'forward' mode, suitable for gantries, platforms, high-access doors, as a grab for standing passengers, machine covers and roller-shutters.

**'FOAMED'
STEEL-CORED
'HAND-HOLD'
150mm**

This unique design complements our range of larger "foamed" grab rails, but is suited to more restricted spaces. It makes an ideal alternative to traditional "6-inch" pulls, with textured, resilient surface, great strength, and a shape that lends itself to fixing in several modes as illustrated.

ORDERING CODE

9/01228 Hand-hold, black
9/01228/01 Hand-hold, red RAL3020

SPECIFICATION

A Body Length	175 mm
B Body Width	100 mm
C Body Height	66 mm
D Hole centres	151 mm
E Cross section	25 mm
H Hole sizes (core)	7 mm

Plug diameter 15 mm accepting bolts to 12 mm head diameter x 7 mm shank.
Plug ref. 5/00538 (specify colour)

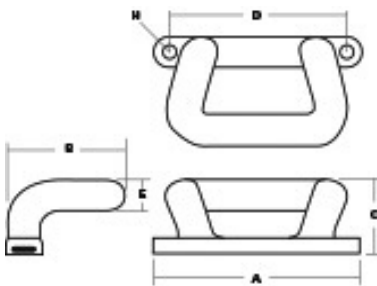

Hand-hold in reverse-mode: suitable for seat backs, trays and containers, trailers and caravans, marine applications.



- !** Resilient, padded surface. No sharp edges, for maximum safety. Triangular section for good grip. Mounting holes concealed by 'snap-in' plugs.
- 🔧** Attractive, textured finish. Standard colours are black and red, other colours can be moulded subject to batch-quantity requirements.
- 🔩** Fixing by bolting through holes in top rail (through steel core).
- M** Moulded in expanded polyurethane foam around welded steel former (core). Meets EC 95/28/CE regulation for combustibility (less than 100mm per minute).

T **LOAD TESTING:**
The handle was tested to destruction, with the following results:
Parallel to axis fixing, max load 14.84 Kilo-Newtons (1.51 tonnes)
Vertical to fixing, max load 13.77 Kilo-Newtons (1.4 tonnes)
With Ultimate strength over 1 tonne we recommend a safe working load of 500Kg (1100lbs) max.



9/01227
Armrest

4
5

UNIVERSAL ARMREST/ GRAB HANDLE

A plant-on, non-'handed' design, this armrest will enhance driver comfort and assist with door closure in almost any cab. With fixing holes normal to the base, and a soft, padded surface the armrest will suit most vehicles, from 'kit' cars to specialist commercial and off-road models.



Non-'handed' for universal fitting. Soft, padded surface for driver comfort.



Fixing holes normal (90°) to panel face, and below 'line of sight' for good visual appearance.



Black, textured finish.



High-density polyurethane foam around rigid steel 'former'. Meets EC 95/28/CE regulation for combustibility (less than 100 mm per minute).

ORDERING CODE

9/01227 Universal arm rest, black

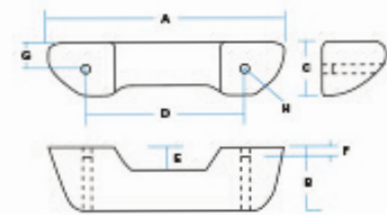

SPECIFICATION

A Body Length	222 mm
B Body Width	60 mm
C Body Height	50 mm
D Hole centres	148 mm
E Grip width	24 mm
F Fixing boss	8 mm
G Location	25 mm
H Hole sizes	6.5 mm



9/01145
(single)



9/01146

SPECIFICATION

A Body Length	51 mm
B Body Width	33 mm
C Body Height	16 mm
D Width (base)	40 mm
E Width (top)	61 mm
F Location	15 mm
H Hole size	5 mm

ORDERING CODE

9/01145 Coat-hook, single

9/01146 Coat-hook, double

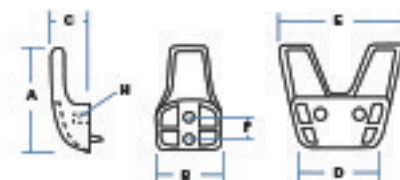

MOULDED COAT-HOOKS

Attractive moulded hooks, retained through fixing hole(s) which are concealed in service by press-shut integral covers. single or double models. Moulded in polypropylene with black, textured finish.

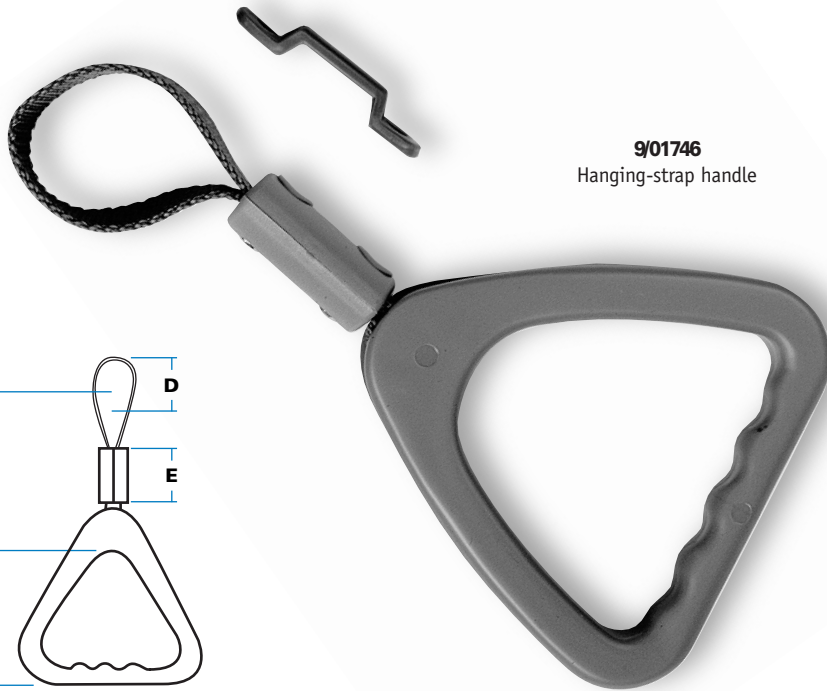
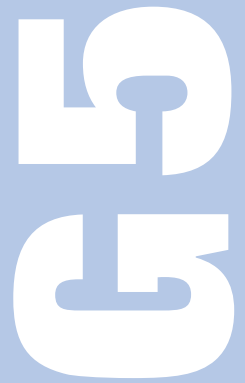

901746
Hanging-strap handle

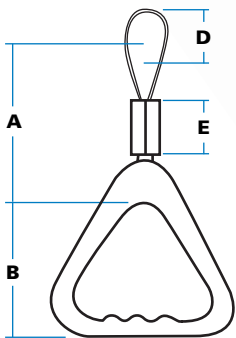

SPECIFICATION

A Height to rail centre (max.)	130 mm
B Grip height	100 mm
C Grip width	130 mm
D Max diameter	50 mm
E Sleeve length	50 mm

ORDERING CODE

901746 Hanging-strap handle, grey

Note: Strap length can be provided exactly to size for volume contract requirements.



Cut strap to desired size and secure with 2-piece sleeve. Attach bracket on top of rail to prevent sideways movement.



Normal finish is grey, black and other colours to special order.



Handle, brackets and strap moulded in polypropylene, (Burning rate less than 100 mm per minute).



On a test-rig, handle withstood loads of 2.1kN (470lbf). Recommended safe load is 1kN (225lbf).

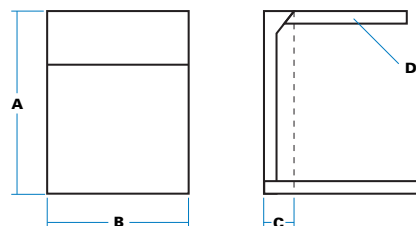

ORDERING CODE

901144 Drinks-holder, black
fixing through 6x5mm holes in back-plate

SPECIFICATION

A Length	100 mm
B Width	95 mm
C Depth	24 mm
D loop diameter	76 mm

FOLD-DOWN DRINK-HOLDER

Here is a useful add-on feature for passenger comfort on coaches, mini-buses and in off-road cabs. When closed, it fits neatly against a panel or seat-back, and opens to hold a cup, bottle or can securely in a moving vehicle.



Fix to vertical surface, pull down front lid and open 'loop'. Springs prevent rattle and accidental closure.



Moulded in ABS with fine textured finish, in black, grey or blue, with stainless springs. Material meets EC 95/28/CE for flammability resistance.



9/00404
(190mm)



9/00405
(280mm)

MOULDED STEEL-CORED HANDLES

Moulded in resilient elastomer around steel cores, these handles have been designed for those applications where great strength is required, but still offering good appearance and 'user-friendly' characteristics.

ORDERING CODE

9/00404 Moulded, steel-cored grab handle 190mm

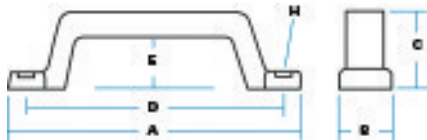

SPECIFICATION

A Body Length	190 mm
B Body Width	28 mm
C Body Height	50 mm
D Hole centres	157 mm
E Under grip	32 mm
H Hole sizes dia within 15 mm dia recess	8 mm

ORDERING CODE

9/00405 Moulded, steel-cored grab handle 280mm

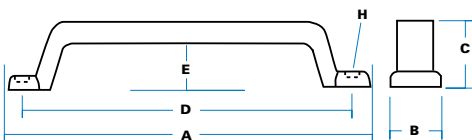

SPECIFICATION

A Body Length	280 mm
B Body Width	28 mm
C Body Height	55 mm
D Hole centres	253 mm
E Under grip	37 mm
H Hole sizes dia within 18 mm dia recess	8 mm

After fixing it is recommended that cover plugs are permanently retained with a suitable adhesive.

Textured plugs are available under following references 9/00404-MP00444 (15mm dia).
9/00405-MP00445 (18mm dia).

! Semi-rigid surface, no hard edges, with plugs to conceal fixings.

🔧 Self-colour black with gloss, textured finish.

🔩 Fixing by bolting through holes in steel core.

M Moulded in thermoplastic elastomer around steel core.

A These handles are direct alternatives to Titgemeyer 588-242 and 633-500 and Furgocar 1908 - 10263/64.

T **LOAD TESTING:**
Tests carried out by an independent proof house gave following results (at 15°C) before destruction.

Parallel to fixing:

9/00404, max load 19.47KN (1.99 tonnes)

9/00405, max load 12.83KN (1.30 tonnes)

Vertical to fixing:

9/00404, max load 13.67KN (1.39 tonnes)

9/00405, max load 12.03KN (1.23 tonnes)

With Ultimate strength over 1 tonne we recommend a safe working load of 500Kg (1100lbs) max.

£ Highly competitive against market alternatives.



'HIGH-GRIP' MOULDED STEEL- CORED HANDLE

Made in same length and construction as 9/00404, this model suits applications where exceptionally high grip is desirable. For example, where handle is fitted within a compartment so that much of its height is hidden by the door frame. Other uses include trailers and caravans, or inside service vehicles where unimpeded access is essential.

9/00403
'High-grip' handle with
steel core

ORDERING CODE

9/00403 'High-grip' handle, black

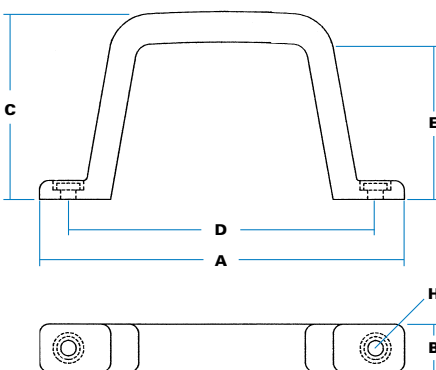

SPECIFICATION

A Body length	190 mm
B Body width	25 mm
C Body height	98.5 mm
D Hole centres	160 mm
E Under grip	82.5 mm
H Hole sizes (diameter) within 15 mm dia. recess	8mm

After fixing it is recommended that cover plugs are permanently retained with a suitable adhesive.

Replacement plugs are available as part reference 5/00538B.



Semi-rigid surface, no hard edges, textured finish with "snap-in" plugs to conceal mounting details.



Self-colour black with textured finish. Other colours subject to batch quantities.



Fixing by bolting through 8 mm holes in steel core and cover with plugs provided.



Moulded in thermoplastic elastomer around steel core.



Rig testing parallel to fixings achieved loads of over (500 Kg) before significant distortion. We recommend a safe working load of 250 Kg (550 lbs.) max.



9/01526

CONCEALED-FIX MOULDED GRAB HANDLE

Clean, sharp lines characterise this new addition to our range, intended for surface-mount applications where fixing from inside is desired. The handle contains threaded brass inserts, moulded-in during manufacture, and has a relatively high grip for a gloved hand.



Black, fine textured finish



Moulded in Nylon-6, glass-bead filled and UV stabilised



LOAD TESTING:
Tests carried out by an independent proof house gave following results:-
Parallel to fixing: Max load 5.50KN (616kg) before fracture.
Vertical to fixing: Max load 4.50KN (504kg) before fracture.
With ultimate strength over 500Kg we recommend a safe working load of 200Kg (440lbs) max.

ORDERING CODE

9/01526 Concealed-fix handle, black

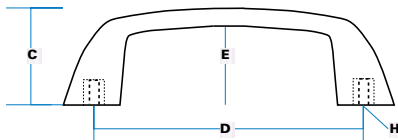
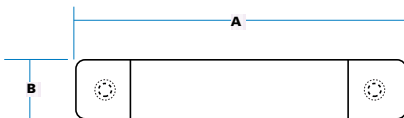

SPECIFICATION

A Body Length	145 mm
B Body Width	26 mm
C Body Height (max)	43 mm
D Hole centres	117 mm
E Under grip	35 mm
H Hole sizes (depth) with M8 threaded inserts	16 mm



9/01790
'Economy' Grab Handle

ORDERING CODE

9/01790 'Economy' grab handle - open fixing

SPECIFICATION

A Body Length	245 mm
B Body Width	25 mm
C Body Height	40 mm
D Hole centres	203 mm
H Hole sizes c/s	7 mm 12 mm

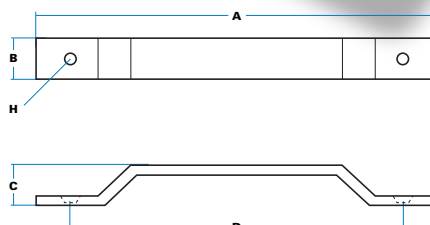

'ECONOMY' GRAB HANDLE

A smart, inexpensive handle with 'plant-on' fixing. It is made in black polypropylene with textured finish, with longitudinal ribbing to lighten weight and increase strength.



LOAD TESTING:
Tests carried out by an independent proof house gave following results.
Parallel to fixing: Max load 3.64 Kilo-Newton (407kg) before handle pulled away from bolts.
Vertical to fixing: Max load 2.87 Kilo-Newton (321kg) before handle pulled away from bolts.
With ultimate strength over 500Kg we recommend a safe working load of 100Kg (220lbs) max.



1/30357
Grab Handle
(173mm)

9/02357
Grab Handle
(203mm)

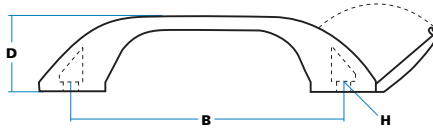
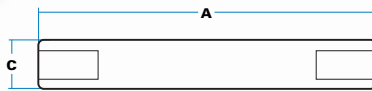

SPECIFICATION

A Length (1/30357)	173 mm
A1 Length (9/02357)	203 mm
B Hole centres (1/30357)	140 mm
B1 Hole centres (9/02357)	170 mm
C Width	30 mm
D Height	38 mm
H Hole sizes within recess	5 x 8 mm 10 x 13 mm

ORDERING CODE

1/30357	Grab handle, black, 173mm
1/30357/02	Grab handle, white (RAL 9016)
9/02357	Grab handle, black, 203mm

PHYSICAL PROPERTIES OF POLYPROPYLENE

Izod\impact strength at 23°C	9.5 kJ/m ²
Embrittlement temperature	-20°C
Heat distortion temperature (4.6kg/cm ²)	95°C
Melting range	165 - 175°C
Burning rate (3 mm) thickness	23mm/minute
UL94 Flammability rating	UL94HB
Resistance to ultraviolet light	After long exposure, some loss of pigment but no detrimental effect on strength

EXTERNAL-FIX GRAB HANDLES

with 'snap-shut' trim panels

NOW IN TWO SIZES!

Two useful grab handles, with integral 'snap-shut' panels to conceal fixing holes. Resilient, strong, with no sharp edges, they suit both inside and outside applications, such as vehicle seat-backs, cabinets, carrying-cases, etc.

- !** Strong, lightweight, attractive.
- !** Plant-on fixing, secured with bolts into slotted holes, integral cover panels.
- !** Textured finish, normal colours black, white and blue/grey. Other colours to special request.
- M** Moulded in polypropylene. See table for physical properties. Meets EC 95/28CE regulation for combustibility (less than 100mm per minute).
- T** **LOAD TESTING:** ON 1/30357: Tests carried out by an independent proof house gave following results (at 15°C).
Parallel to fixing: Max load 3.00 Kilo-Newtons (306kg) before handle pulled away from bolts.
Vertical to fixing: Max load 1.24 Kilo-Newtons (126kg) before handle pulled away from bolts.
 With ultimate strength over 300Kg we recommend a safe working load of 100Kg (220lbs) max.



7/28745

ORDERING CODE

7/28745 Diecast handle-chrome

7/28746 Diecast handle-black

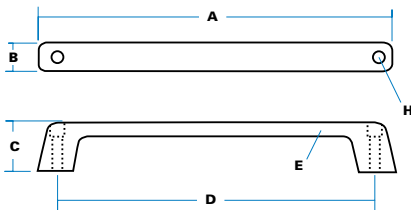

SPECIFICATION

A Body Length	150 mm
B Body Width	18 mm
C Body Height	37 mm
D Hole centres	136 mm
E Section min	7 mm
H Hole sizes (diameter)	6 mm, c/s 10 mm
recess depth 7mm,	body depth 25 mm

EXTERNAL-FIX GRAB HANDLE 150mm

A substantial diecast handle, with sufficient height to allow good grip. It is fixed externally through two deep-recessed mounting holes.



Well-styled high-standing alternative to traditional "6-inch" pulls.



Polished and bright chromium-plated, or black powder-coated.



7/35442

ORDERING CODE

7/35442 Grab handle-chrome

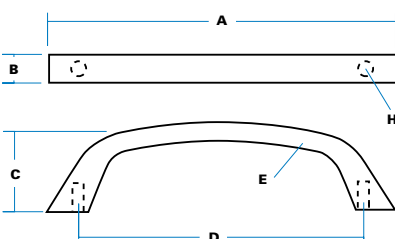

SPECIFICATION

A Body Length	110mm
B Body Width	13mm
C Body Height	25mm
D Hole centres	89mm
E Section	4mm
H Hole sizes (depth)	8mm
tapped 10-32 UNF	

CONCEALED-FIX DIECAST GRAB HANDLE

A neat 'cabinet' handle, suitable for cupboards and drawers and fixed from behind by two screws (not provided). Finish is bright chromium plated.

DIECAST GRAB-RAIL 250mm



9/00214
(black)

9/00224
(chrome)

This model was designed with clean, modern lines in reaction to traditional 'commode' style diecast grab handles with thin sections and curved shapes. It is ideal for use as an entry-assist on rear and side doors of trucks and vans, for compressor and engine covers, and on containerised gen-sets.



Low profile and wide section for good grip, with no sharp corners or edges. Fully plant-on, with semi-concealed fixing holes.



Black powder-coated or hand-polished and chromium plated. Special colours on request, volume permitting.

CONCEALED-FIX DIECAST GRAB HANDLE

An attractive handle with 'streamlined' design to avoid sharp corners, with fixing from underneath into two tapped holes. Available in hand polished chromium-plated finish, or black powder-coated.

ORDERING CODE

9/00214 Diecast grab rail-black

9/00224 Diecast grab rail-chrome

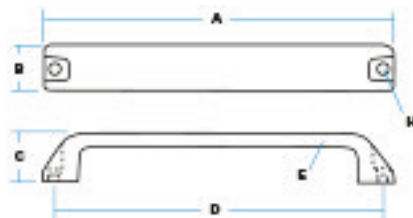

SPECIFICATION

A Body Length	255 mm
B Body Width	33 mm
C Body Height	35 mm
D Hole centres	238 mm
E Section min (ribbed)	3 mm
H Hole sizes (diameter)	7 mm, c/s 12 mm



7/10668
(chrome)

ORDERING CODE

7/10668 Grab handle-chrome

7/10669 Grab handle-black

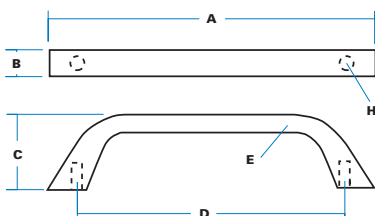

SPECIFICATION

A Body Length	136mm
B Body Width	13mm
C Body Height	32mm
D Hole centres	114mm
E Section	8mm
H Hole sizes (depth) tapped 10-32 UNF	8mm



1/29990

ORDERING CODE

1/29990 Ashtray, black, c/w bracket

Aperture size: 90mm & 58mm

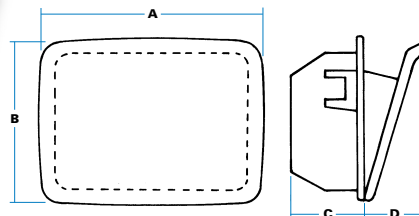

SPECIFICATION

A Length	100 mm
B Width	71 mm
C Depth	32 mm
D Max projection	38 mm

WALL-MOUNTED ASHTRAY

Attractive, moulded ashtray for recess fitting into simple cut-out, secured by screw and steel 'U'-bracket (provided). Textured finish in black ABS, suits side-panel, seat-backs, etc. Meets EC 95/28/C for combustibility. Easily separated for cleaning.

'Plant-in' Ashtray



1/29371

ORDERING CODE

1/29371 Ashtray, black lid

7/35270 Ashtray, chrome lid

Aperture size: 66mm & 53mm

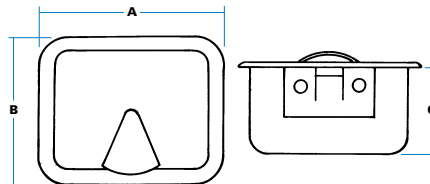

SPECIFICATION

A Length	82 mm
B Width	70 mm
C Depth	35 mm

'PLANT-IN' ASHTRAY

A neat metal ashtray which fits into a horizontal recess (armrest, transmission tunnel, etc), retained by spring clip but can be pulled-out for cleaning. Chromium-plated bowl and snuffer, black or chrome lid.

'Plant-in' Ashtray



7/04008

ORDERING CODE

7/04008 Ashtray assembly, chrome

Aperture size: 62mm & 53mm

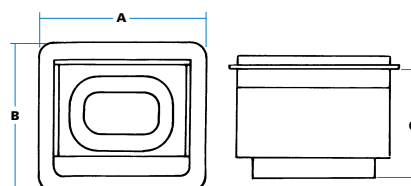

SPECIFICATION

A Length	70 mm
B Width	62 mm
C Depth	45 mm

'PLANT-IN' ASHTRAY WITH INNER BOX

A high-quality diecast ashtray which fits into a horizontal recess, and is retained by fixing holes in base of main body. Inner container removed for emptying, with bright-plated roll-top lid.

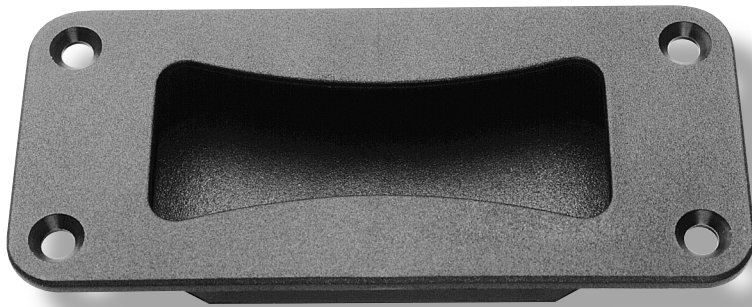

9/01390
Grab Handle

ORDERING CODE

- 9/01390 Recess grab handle, moulded
- 9/01391 Recess grab handle, diecast

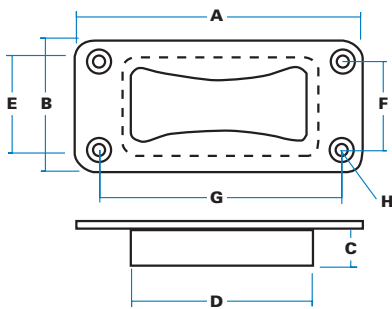

SPECIFICATION

A Length (outer)	133 mm
B Width (outer)	60 mm
C Depth	21 mm
D Length (inner)	95 mm
E Width (inner)	45 mm
F Hole centres	41 mm
G Hole centres	114 mm
H Hole sizes (diameter)	6 mm, c/s 10 mm

Note: Because of construction detail, there are projections on dimension 'D' to 115 mm on diecast model.



9/01388
Window-pull handle
(front view)

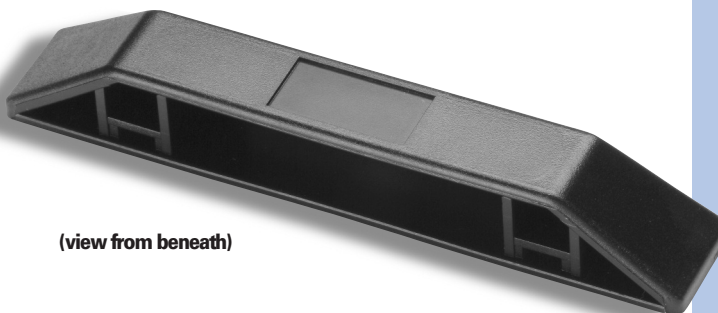

(view from beneath)

ORDERING CODE

- 9/01388 Window-pull handle

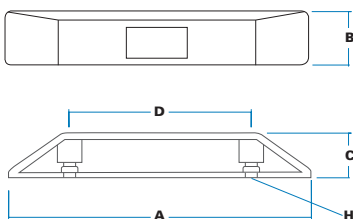

SPECIFICATION

A Length	200 mm
B Width (max)	35 mm
C Depth	30 mm
D Hole centres	120 mm
H Hole sizes (dia)	8mm

Note: Nut 'pockets' are 11 mm max. width

**DOUBLE-SIDED
FLUSH-FIT
GRAB HANDLES**

This design is available in both diecast and moulded construction. It is completely flush-fitting and easy to fix into panel aperture. The shaped edges allow easy action with roller shutters and sliding doors. Use the diecast version when handle is used to lift heavy equipment.



Fix through countersunk holes in top plate.



Diecast handle is black powder-coated, moulded handle has textured finish.



Diecast in zinc alloy, or moulded in glass-filled nylon with top and bottom plates ultrasonically welded together.

**WINDOW-PULL
HANDLE
(CONCEALED-FIX)**

This useful handle is used for pull-open windows in buses and coaches, and similar applications. It is fitted to the inside of the glass and is held by two bolts from outside, secured into hidden nuts contained in 'pockets' within the handle

Note: Some restrictions on availability may apply



Secure from outside through two holes in base of handle, into 11mm 'nut pockets'



Moulded in high-impact ABS with fine textured finish.

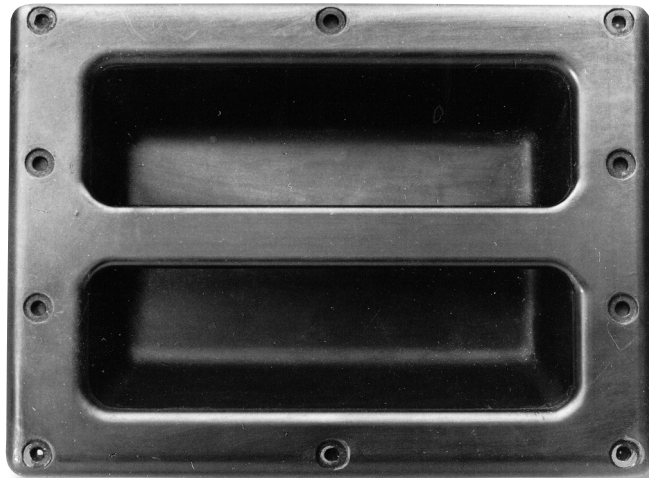

9/01389/01
Grab Handle

ORDERING CODE

9/01389/01 Flush-fit grab handle- black

SPECIFICATION

A Length	230 mm
B Width	170 mm
C Depth	30 mm
D Strap width	22 mm
E Hole centres	203 mm
F Hole centres	153 mm
H Hole sizes (diameter)	5 mm, 10 mm recess

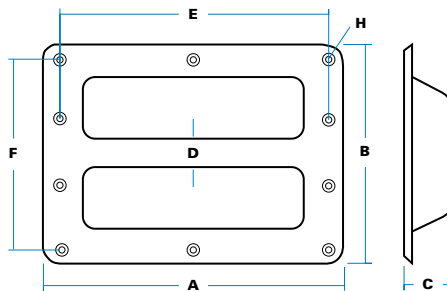

Consult engineering drawing for details of hole positions. Frame in 2 mm galvanised steel.

FLUSH-FIT STEEL GRAB HANDLE
encapsulated in
synthetic rubber (TPE)

A fully-recessed grab handle, large enough to receive a gloved hand. The unit is completely corrosion-resistant and shaped to allow run-off of water (spray, etc.). It is suitable for large commercial vehicles and trailers, etc.

- !** Galvanised steel frame with resilient moulded covering for user-friendly feel.
- 🔧** Smooth, semi-gloss finish. Standard colour is black.
- 🔩** Fixing through recessed holes in rim, use stainless steel or plated screws/rivets to avoid corrosion stains.

T **LOAD TESTING:**
Rig testing parallel to fixings achieved loads of over 6.00KN (610Kg) before significant distortion. We recommend a Safe Working Load of 200Kg (440lb)

THERMAL TESTING:
Cycled between +15°C & -30°C without embrittlement. Does not soften below +70°C.



9/01115
Grab Handle

ORDERING CODE

9/01115 Semi-flush handle-black
5/00939 Moulded gasket

SPECIFICATION

A Width	125 mm
B Centres	90 mm
C Depth	16 mm
D Height	10 mm
H Holes (diameter)	5 mm, C/S 9 mm
Inside diameter of pan 105 mm. Edges are embossed	

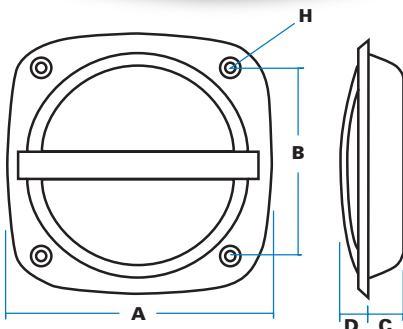

SEMI-FLUSH STEEL HANDLE

This model uses the same recess pan as our 'T' handle sets, 9/00186 etc, with a 10mm steel 'strap' welded across the recess to provide a strong, neat, semi-flush handle, Black finish, gasket supplied separately



9/00166SS

9/00163SS

ORDERING CODE

9/00163SS Stainless steel rail, 104 mm.

9/00166SS Stainless steel rail, 165 mm.

SPECIFICATION

	9/00163	9/00166
A. Length	104 mm	165 mm
B. Height	50 mm	50 mm
C. Hole centres	96 mm	157 mm
H. Hole sizes	M5	M5

Supplied with 2-off chromium-plated screws, M5 x 10 mm (ref. MP 00078).

Bar diameter:	9 mm
---------------	------

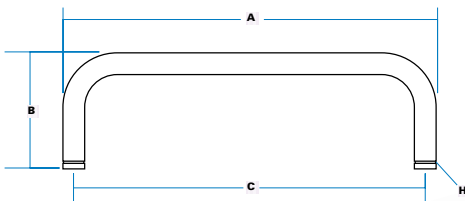

Widely used for electrical cabinets and equipment drawers, these handles are rolled from 9 mm stainless steel bar, bright polished.

Ends are drilled and tapped M5, and two screws are supplied for mounting from beneath.

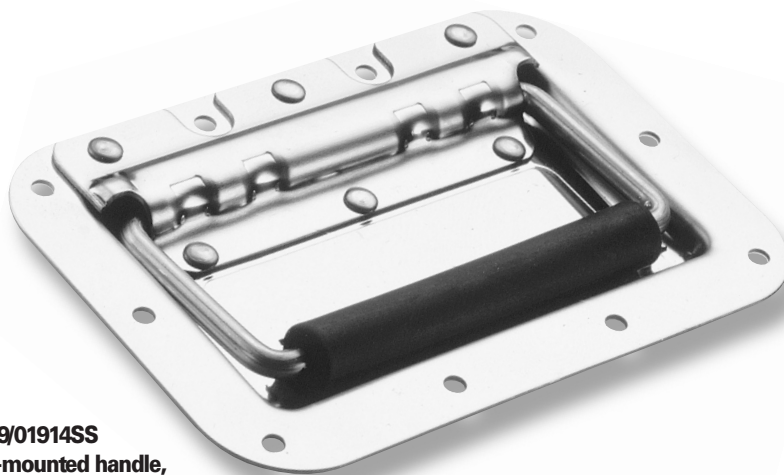

9/01914SS
Recess-mounted handle,
stainless steel

**LIFT-UP HANDLES
- RECESS
MOUNTING**

Very useful, plant-on 'chest' handle, with attached backplate and concealed spring which returns to 'rest' position. Stainless steel throughout, with 'grip' in resilient rubber. Also available for surface mounting (without recess plate) to special order.

ORDERING CODE

9/01914SS Recess handle, stainless steel

SPECIFICATION

A Plate Length	160 mm
B Pan Width	107 mm
C Pan Depth	6 mm
D Grip Length	110 mm
E Grip Diameter	12 mm
H Hole sizes (dia.)	6 mm

Angle of opening 85°. Consult engineering drawing for position of (10) fixing holes. Panel cut-out dimensions 75mm x 127mm.

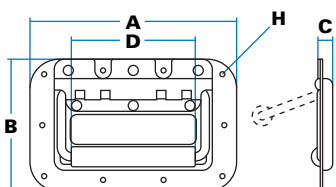

1/20550
Grab Handle



ORDERING CODE

1/20550 'Traditional' grab handle chrome

SPECIFICATION

A Total Length	165 mm
B Width (max)	41 mm
C Height (max)	46 mm
D Hole centres	140 mm
E Hole centres	19 mm
H Hole sizes (diameter)	5mm, c/s 10 mm

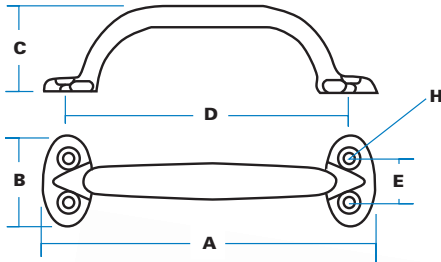

**'TRADITIONAL'
GRAB HANDLE**

Traditionally-styled handle for plant-on fitting. Hand-polished and chromium plated to a very high standard. Other finishes to special order.

7/28362
Grab Handle



ORDERING CODE

7/28362 'C' handle - chrome

7/28363 'C' handle - black

7/28364 'C' handle - raw finish

SPECIFICATION

A Total Length	155 mm
B Width (offset)	45 mm
C Height (max)	48 mm
D Hole centres	105 mm
H Hole sizes (diameter)	7 mm, c/s 11 mm

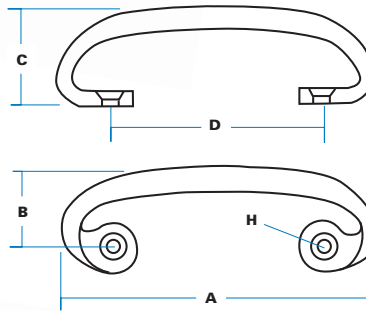

**'C - TYPE'
GRAB HANDLE**

Exceptionally strong handle with constant-section to avoid areas of weakness found in competitors' models. Hand-polished and chromium plated to very high standard. Also in black and raw finish

1/20574
Grab Handle



ORDERING CODE

1/20574 Lowline grab handle, chrome

SPECIFICATION

A Total Length	168mm
B Width (max)	23mm
C Height	30mm
D Hole centres	140mm
H Hole sizes (diameter)	7 mm, c/s 11 mm

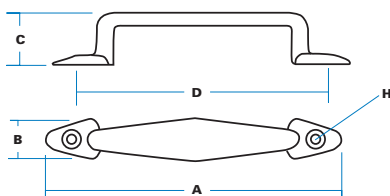

**'LOWLINE'
GRAB HANDLE**

A traditional design with shaped 'grip' area, and with low, flat styling for minimal projection. Hand polished and chromium plated to very high standard.

HARDWARE

**FUEL FILLER
CAPS, VALVES,
VENTILATORS &
LOAD CONTROL**



Our 'panic-button' emergency-stop unit suits generators and compressors. Recess pan is in stainless or black finish.

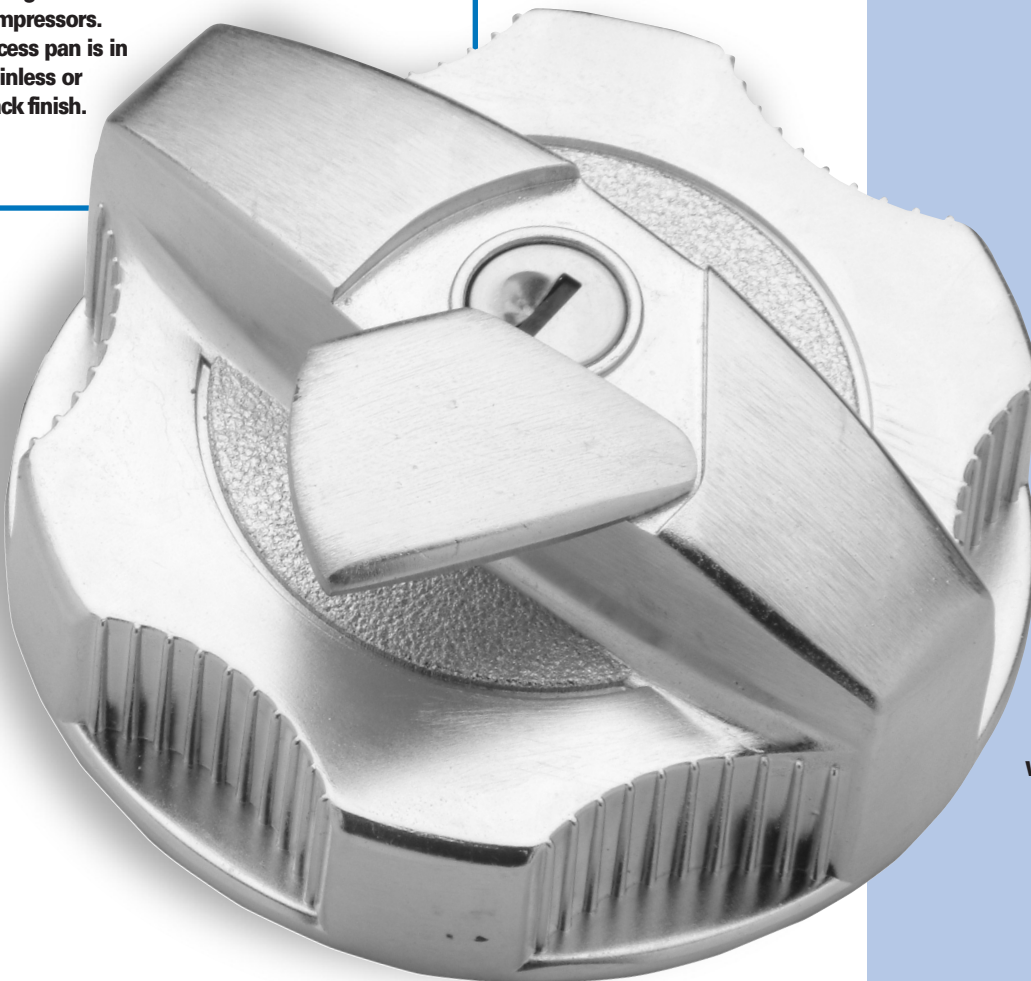

Above: New diecast fuel-filler cap has sliding 'weathershield' which protects keyhole from water and debris. Normally in black finish.

This 'hardware' section includes a number of different product lines where WBH has developed expertise. In particular, the range of filler caps has proved useful for both on-road and specialist vehicle applications, with robust diecast models for heavy construction plant. Additional items such as the rotary ventilator find many uses in vans and trailers.



'Snap-in' Barrel
'FS' or 'FT'



'Customised'
Key

604130
Locking cap



Double-sided "FT"
keys only

HEAVY-DUTY LOCKING FILLER CAP [& NECKS]

A sturdy, diecast cap designed for construction plant and heavy trucks, with a 'snap-in' barrel, allowing the cap to be matched with a full vehicle lock-set. A sliding diecast plate protects the key-aperture from water and debris.

Recommended specification is fully sealed, but caps can be vented for some applications. This model suits "internally-flanged" neck-ends, (illustrated) which can be brazed onto a plain filler pipe, generally at 76 mm (3 inch) diameter.

! Double-walled diecast construction with 'skirt' protecting the latch 'bayonet'. Finger-bar and scalloped edge for good grip, cover plate for weather-resistance.

W Rotate (unlocked) cap on filler neck until fully engaged, then turn key to operate latching tongue. Key only withdraws in 'locked' position.

K 'FT' keys as standard, with shuttered keyway. Optionally 'FS', 'DLP' or 'Ronis' key types.

W Black as standard. Other colours to request (red or yellow for diesel, etc).

M Zinc alloy diecastings, with steel 'bayonet' and latch, and bonded steel/nitrile rubber seal.

? - Coloured finishes
- 'Bayonets' at 45 & 55 mm
- Optional retaining chain
- Special key numbers/sets
- 'Customised' key types

T Caps are 100% tested to withstand tank pressure of 0.14 KgF/cm² (2 lb/in²) Inversion tests ensure caps do not exceed permitted flow rates on valved/vented models

ORDERING CODE

604130 Filler cap, black, non-vented

604131 Filler cap, black, vented

616900 Steel neck-end, (76 mm pipe)

(Ask for advice on suitability of caps where tank venting is required. EC regulations may apply.)

SPECIFICATION

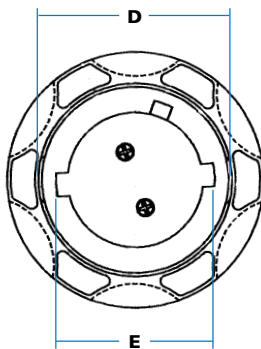
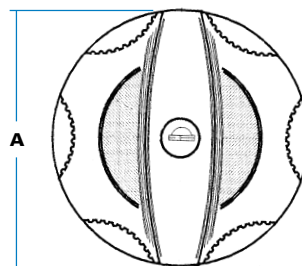
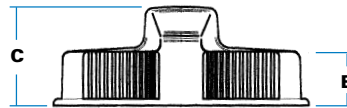

A Diameter	110 mm
B Base height	23 mm
C Max. height	44 mm
D Inside diameter	83 mm
E 'Bayonet' diameter	68 mm

Note: Alternative 'bayonets' can be fitted at 45 mm & 55 mm diameter, but these will reduce resistance of cap to vandal attack.

Filler neck ends

These are internally-flanged neck ends in mild steel, suitable for brazing to plain pipes at 76 mm (3 inch) and 57 mm (2.25 inch) diameter. Height is 18-20 mm only. Also in aluminium.

616900
78mm I.D.
(accepts
68 mm
bayonet)



616901
58mm I.D.
(accepts
45 mm
bayonet).





Non-locking cap with optional chain

Optional 'Snap-in' Barrel 'FS' or 'FT'



'Customised' Key option



Locking cap with optional 'Diesel' labels

ORDERING CODE

'Non-vented' models with 68 mm bayonet

- 602935** 'Chunky' cap locking, black
- 602936** 'Chunky' cap, non-locking, black
- 602888** 'Chunky' cap, locking, grey
- 604122** 'Chunky' cap, non-locking, grey

'Vented' models with 68 mm bayonet

- 600281** 'Chunky' cap, locking, black
- 600296** 'Chunky' cap, non-locking, black

616900 Steel neck-end, 77 mm diameter

616901 Steel neck-end, 58 mm diameter

(Ask for advice on suitability of caps where venting is required. EC regulations may apply).



616900
78mm I.D.
(accepts
68 mm
bayonet).

616901
58mm I.D.
(accepts
45 mm
bayonet).

SPECIFICATION

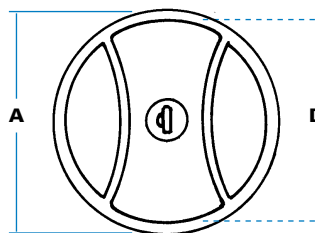
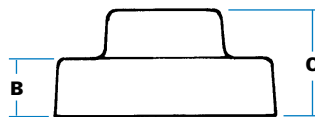

A Diameter	87 mm
B Base height	24 mm
C Max. height	42 mm
D Inside diameter	84 mm
E 'Bayonet' diameter (not shown)	68 mm

Note: Alternative 'bayonets' can be fitted at 45 mm & 55 mm diameter, but these will reduce resistance of cap to vandal attack.

Filler neck ends

These are internally-flanged neck ends in mild steel, suitable for brazing to plain pipes at 76 mm (3 inch) and 57 mm (2.25 inch) diameter. Height is 18-20 mm only.

**'CHUNKY'
COMMERCIAL
FILLER CAPS
[& NECKS]**

This model has been used by every British truck manufacturer as well as for 'static' applications such as power generator sets. Recommended specification is fully sealed but the 'Waso' venting system will suit some applications. Caps fit "internally-flanged" neck-ends, (illustrated) which can be brazed onto a plain filler pipe, generally at 76 mm (3-inch) diameter.

- !** Attractive, moulded 'shroud' with textured finish, and shaped top for good grip. 'Snap-in' lock barrel allows cap to be matched with full vehicle lockset.
- W** Rotate cap on filler neck until fully engaged. On locking models, turn key to operate latching tongue. Key only withdraws in 'locked' position.
- K** 'S'-type key as standard, with shuttered keyway. Optionally 'FS', 'FT', 'DLP' or 'Ronis' key types.
- H** Textured finish in black or grey. Other colours to special order only.
- M** Zinc alloy diecastings, with mineral-filled polypropylene shroud, steel 'bayonet' & latch, and bonded steel/nitrile rubber seal.
- ?** - Valved/vented specification
- 'Bayonets' at 45 & 55 mm
- Optional retaining chain
- 'Diesel' labels
- 'Snap-in' barrel
- 'Customised' key types.

T Caps are 100% tested to withstand tank pressure of 0.14 KgF/cm² (2 lb/in²) Inversion tests ensure caps do not exceed permitted flow rates on valved/vented models.

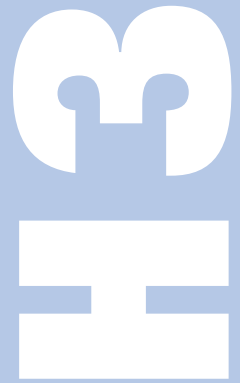

604021
'Finger-bar' cap, black



604023
'Diesel' cap, red.

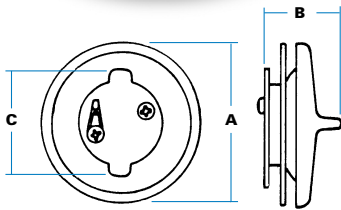

ORDERING CODE

'Non-vented' models (fully sealed)

604020 Finger-bar cap, grey

604021 Finger-bar cap, black

604023 Finger-bar cap, red (diesel)

'Valved & vented' models

604005 Finger-bar cap, grey

606581 Finger-bar cap, black

606090 Finger-bar cap, red (diesel)

SPECIFICATION

A Diameter 72 mm

B Height 30 mm

C Bayonet diameter 45 mm

A steel neck-end (616901) suits these caps, suitable for brazing to plain pipes at 57 mm (2.25 inch) diameter.

NON-LOCKING MOULDED FILLER CAPS

These caps have been widely used for on-road passenger cars and vans, as well as for industrial engines and static fuel tanks. There are two styles, with either 'finger-bar' or 'knurled rim', and both can be supplied in red with raised, "diesel" lettering. Recommended specification is fully sealed, but the 'Waso' venting system will suit some applications. Caps fit "internally-flanged" necks at 57 mm (2.25 inch) diameter, and steel or diecast neck-ends are available.

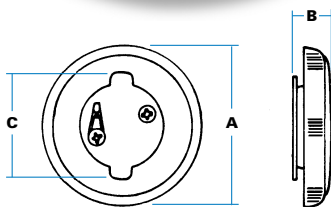

604016
'Diesel' cap, red.

ORDERING CODE

'Non-vented' models (fully sealed)

604011 Knurled cap, black

604016 Knurled cap, red (diesel)

'Valved & vented' models

604001 Knurled cap, black

604006 Knurled cap, red (diesel)

(Ask for advice on suitability of caps where venting is required. EC regulations may apply).

SPECIFICATION

A Diameter 72 mm

B Height 18 mm

C Bayonet diameter 45 mm

A screw-on diecast neck end (616421) can be used with this type of cap (with special bayonet).

- !** Visually attractive caps, resistant to scratching and corrosion, shaped for easy opening and removal.
- 🔧** Rotate cap on filler neck until fully engaged against ramped form.
- 🔧** Gloss finish on finger-bar caps in black, grey or red. Textured finish on 'knurled' caps in black or red.
- M** Acetal mouldings, with steel bayonet and bonded steel/nitrile rubber seal.
- ?** - Valved/vented specification
- 'Bayonets' at 45 & 55 mm
- Optional retaining chain
- T** Caps are 100% tested to withstand tank pressure of 0.14 KgF/cm² (2 lb/in²)
Inversion tests ensure caps do not exceed permitted flow rates on valved/vented models.

Retro-fit neck-end





604037
'Trimlock' cap with closed flap showing "skirt" at base



Standard 'S' series keys



604038
'Trimlock 2' cap with flap open

ORDERING CODE

'Non-vented' models (fully sealed)

604037 'Trimlock' cap, black

604038 'Trimlock-2' cap, black

'Valved & vented' models

604039 'Trimlock' cap, black

604040 'Trimlock-2' cap, black

616901 Steel neck-end, 58mm diameter

616421 Diecast filler neck

(Ask for advice on suitability of caps where venting is required. EC regulations may apply).

'Trimlock' & 'Trimlock-2' models

The original 'Trimlock' design sits neatly over the filler neck. Because this can be restrictive in some cases, the 'Trimlock-2' model has no "skirt", with wider diameter to give a lower, more streamlined appearance.



SPECIFICATION

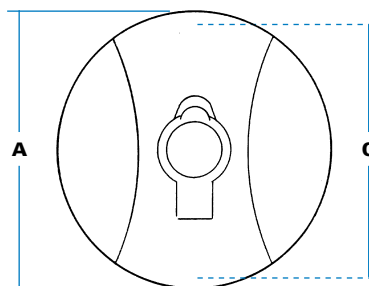
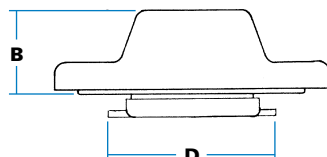

A Outside diameter (Trimlock)	70 mm
A Outside diameter (Trimlock-2)	78 mm
B Height	24 mm
C Inside diameter (Trimlock only)	65 mm
D Bayonet (Standard)	45 mm

Diecast filler neck-end (616421)

This diecast 'adaptor' ring fits a plain or externally-flanged pipe at 58 mm (2.25 inch) diameter, and is secured with two self-tapping screws. Aperture width is 42 mm, requiring the 37 mm 'bayonet' on accompanying cap.



'RETRO-FIT' LOCKING FILLER CAPS & NECKS

Designed by the 'Waso' company for the automotive aftermarket, these caps are useful when it is desired to add an inexpensive lock to a fuel tank as a security measure. A diecast neck-end (which can be fitted on-site) allows caps to be used even on plain filler pipes. The two models illustrated are identical apart from some details of cover mouldings.

! Smart moulded 'shroud' with unique flap design to prevent water ingress. Shape allows easy removal even in confined spaces.

W Rotate (unlocked) cap on filler neck until fully engaged, then turn key to operate latching tongue. Key only withdraws in 'locked' position.

K 'S'-type double-sided keys.

F Black textured finish.

M Zinc alloy diecast, with mineral-filled polypropylene shroud, steel 'bayonet' & latch, and bonded steel/nitrile rubber seal.

? - Valved/vented specification
- 'Bayonets' at 37, 45, & 55 mm
- Optional retaining chain
- 'Diesel' labels

T Caps are 100% tested to withstand tank pressure of 0.14 KgF/cm² (2 lb/in²) Inversion tests ensure caps do not exceed permitted flow rates on valved/vented models.

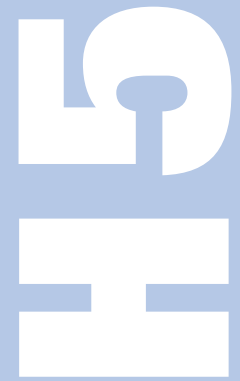

602691
Castellated cap with
optional chain

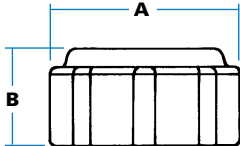

SCREW-TYPE (NON-LOCKING) FILLER CAPS

Two models of moulded cap with internal screw-thread, designed for 60 mm-diameter necks with matching thread.

The smaller cap has castellated ridges for good grip, and 'diesel' embossed on the top surface. It can be supplied fully sealed, or valved and vented. Normal finish is semi-gloss black, with colours on request. A chain is optional.

The larger cap will fit the same neck but has a ratchet-ring to prevent overtightening, and a central finger-bar. It is fully sealed, with black fine-textured finish.

SPECIFICATION

A Diameter	66 mm
B Height	36 mm

Internal diameter 60 mm x 6 mm buttress thread (see engineering drawing for details of thread).

ORDERING CODE

602691	Castellated cap, non-vented
601576	Castellated cap, valved & vented



603246
Ratchet cap

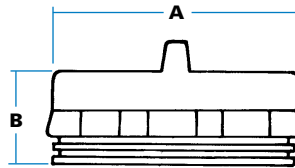

ORDERING CODE

603246	Ratchet cap, non-vented
---------------	-------------------------

SPECIFICATION

A Diameter (max)	76 mm
B Height (max)	54 mm

Internal diameter 60 mm buttress thread. Ratchet torque is 1.5 - 2.0 NM. Cap seals to pressure of 4 lb/in² when tightened to first 'click' of ratchet.

M Moulded in acetal, with nitrile rubber seals

T Caps are 100% tested to withstand minimum tank pressure of 0.14 KgF/cm² (2 lb/in²). Inversion tests ensure caps do not exceed permitted flow rates on valved/vented models.

FUEL TANK VACUUM-RELIEF VALVES

These one-way valves allow air to be drawn into the fuel tank, assisting flow and preventing implosion, but do not allow fuel vapour to be released.

Push-fit hoses allow valves to be connected to a spur-pipe, with inlet usually between body panels or other convenient location.

Valves normally contain a steel ball, but with a nylon ball they operate without fuel leakage at an angle of 90° to horizontal.

Material is acetal.

DIRECTION OF
AIR FLOW

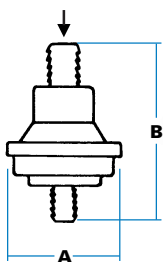

693296
Valve with hoses
attached



694035
Valve only



ORDERING CODE

694035	Relief valve only, (steel ball)
693296	Relief valve & hoses (steel ball)
693041	Relief valve only, (nylon ball)
693202	Relief valve & hoses (nylon ball).

SPECIFICATION

A Diameter (max)	36 mm
B Height (max)	54 mm

Upper spigot, diameter 9 mm (hose 14 mm)
Lower spigot diameter, 6 mm (hose 11 mm)

'PANIC BUTTON' EMERGENCY STOP-SWITCH & RECESS PAN

A neat self-contained and cost-effective unit which allows an engine or power-supply to be shut-down immediately. It comprises a red 'panic button' and contact block, which is easily assembled into a stainless steel recessed pan. Applications include power generators, compressors and public service vehicles where safety considerations apply.



9/01433 & 9/01463
Emergency stop switch
assembled into recess
pan

Rear-view of assembled
switch and recess pan

ORDERING CODE

- 9/01433** Emergency-stop pan & gasket
9/01463 Emergency-stop switch & contact block

SPECIFICATION

A	Pan total width	125 mm
B	Hole centres	90 mm
C	Projection, button	13 mm
D	Total depth of pan	43 mm
E	Projection, contactor	16 mm
F	Diameter, 'cup'	80 mm
H	Hole sizes (dia)	4.75 mm, c/s 9 mm

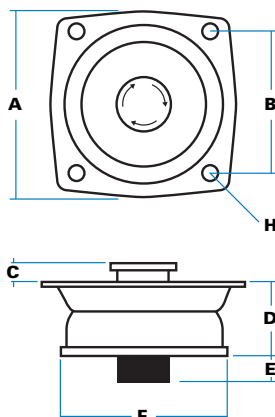

Illustration shows switch and pan in assembled condition, (without gasket for clarity).



Push-button switch and connector block are supplied as separate parts, to be fitted through pan aperture and assembled.

! Highly visible button within bright-polished pan, with welded rear 'cup' for attachment of water-resistant cover, and moulded gasket.

W Punch button to close switch and stop power-supply. Turn button to release.

M Insert button from front, through pan and into contact block, and turn 90° to engage. Then tighten two screws provided to secure block against rear of pan.

H Bright-polished stainless steel pan with moulded gasket. Zinc-plated switch with red moulded button. Pan also available in black.

T Switch is tested for make-&-break to 6 amps, at 415 V. AC. It is suitable for 12-240 volts AC/DC, with thermal current rating of 10 amps. Conforms to IS.13947/5I, from -25°C to +70°C

Ignition
Switches

A17



NEW MODEL ROTARY VENTILATOR WITH INSIDE GRILLE & ADAPTOR

WBH is delighted to introduce a new rotary ventilator, under exclusive UK licence from our long-time trading partner, UES International, of Australia.

The new model is better-looking and up to 25% more efficient in removing stale air from within a vehicle. Most significantly, however, UES has now created an inside adaptor-ring, allowing neat and easy installation of an inside grille, concealing all fixing screws and making the ventilator entirely suitable for mini-buses and other 'prestige' applications

! Construction prevents entry of rain, dust, and down-draughts. Air-scoop revolves on two steel bearings and will catch breeze even in stationary (exterior) locations. Quiet in operation with excellent rate of air-movement.

W Rotary scoop drives extraction fan, sucking air from inside vehicle compartment.

H Ventilator in black or white self-colour, adaptor & grille in black only.

M Four stainless screws/nuts provided & clips for inside grille.

H Black self-colour moulded ventilator as standard (white & grey as options). White base, and white moulded grille.

M Moulded in ABS with two steel bearings and stainless steel centre-shift

£ Highly competitive against market prices.

Base, spindle & bottom bearing

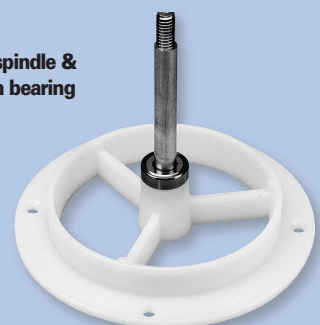

ORDERING CODE

9/01855 Ventilator only, black

9/01856 Ventilator only, white

9/01857 Adaptor & grille, black

Air-Extraction

Vehicle Speed		Volume	
MPH	KPH	Cu. ft/min	Cu. M/min
20	12	0.75	26
40	25	1.72	61
60	38	2.55	90
80	50	3.45	122
100	62	4.27	151
120	75	4.70	167
140	87	5.10	180

Installation Instructions

Remove moulded top cap, unscrew locknut and separate scoop from base. This can now be attached to outside roof around pre-cut 96mm diameter hole in panel, using four screws provided. On inside, fit adaptor ring to screws and secure with nuts. Re-assemble scoop and tighten centre locknut. Inside grille fits onto adaptor and is secured with clips provided.

SPECIFICATION

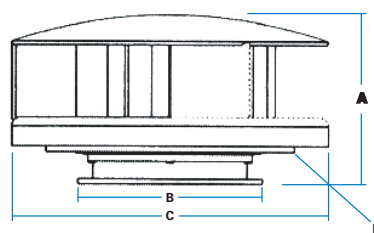

A Height (maximum)	120 mm
B Base diameter	140 mm
C Scoop diameter	240 mm
D Grille outer diameter	160 mm
E Depth of adaptor/grille	30 mm
F Hole centres (across base)	124 mm
F Hole sizes (dia)	5 mm, c/s 8 mm

wieght of Unit 660 grams (1.5lb)

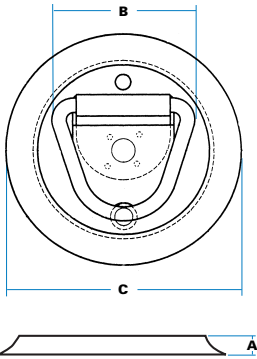

9/01181
Tie-down
ring & Shroud

TIE-DOWN RING & SHROUD

This useful steel tie-down has a moulded shroud for plant-on fixing to wall or floor. A high-tensile bolt should be used, fitting through steel support plate. There is a rubber plug to 'cushion' ring and prevent rattle. Bright zinc-plated.

ORDERING CODE

9/01181 Tie-down ring & shroud

9/01182 Tie-down ring only

Safe Working Load: 250 Kg.

SPECIFICATION

A Height	10 mm
B Loop width	50 mm
C Diameter	112 mm

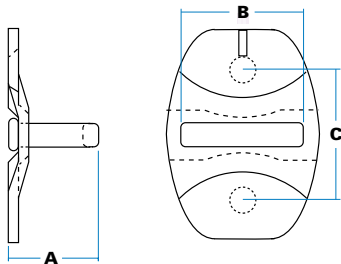

3/21330
Tie-down loop

TIE-DOWN LOOP

A plant-on, fixed loop able to accept very high loads. Welded assembly, hardened and bright zinc-plated with 7 mm fixing holes, countersunk to 13 mm.

ORDERING CODE

3/21330 Tie-down loop

Safe Working Load: 500 Kg

SPECIFICATION

A Height	27 mm
B Loop width	40 mm
C Hole centres	38 mm



9/01907
'Closed' Bracket
(1804)



9/01911
'Open' Bracket
(1844)

ORDERING CODE

9/01907 Decking bracket - closed ('1804')

9/01911 Decking bracket - open ('1844')

SPECIFICATION

A Bracket inside width	41 mm
B Bracket height	65mm
C Bracket length	78 mm

DECKING BRACKETS

Steel brackets in 3 mm material, used with '1806' type perforated track to make removable loading floors or stowing beams. (For example, will accept a wooden beam of 70 x 40 mm). 'Open' and 'closed' types, zinc-plated.

**PRODUCTS IN
STAINLESS STEEL**

This is a quick guide to the various WBH products available in '300' series (austenitic) stainless steel, for superior corrosion-resistance and use in demanding environments.

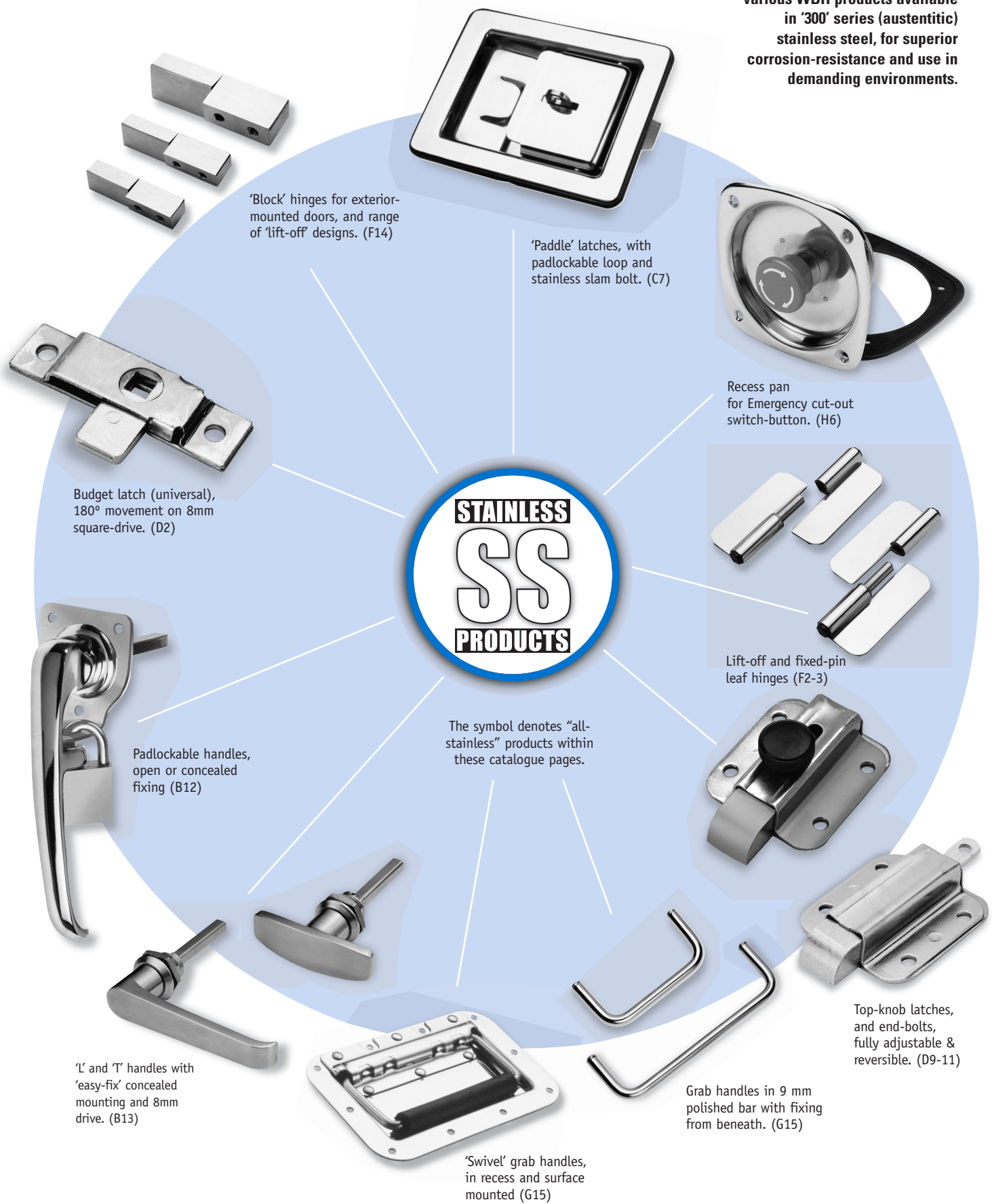

OUR FULL PRODUCT RANGE

COMPARTMENT LOCKS
'DROP-T' & 'PADDLE' LATCHES
'L' & 'T' HANDLES
ROD & SLAM LATCHES
BUDGET LATCHES
SUPPORT STAYS
ANTI-BURST SYSTEMS
INSIDE RELEASES
WINDOW REGULATORS
ARMRESTS & GRAB RAILS
STEERING COLUMN LOCKS
SPECIALITY HINGES
FILLER CAPS
IGNITION SWITCHES
ASHTRAYS & COATHOOKS
DOOR HOLDBACKS

Weston Body Hardware is a manufacturing company that provides purpose-designed systems in the whole area of access control, and maintains an extensive range of standard products as illustrated in this catalogue.

**We are represented by
agents and distributors
in most countries.
Ask for details**

Presented by:

WBH
WESTON BODY HARDWARE

Crossgate Road, Park Farm, Redditch B98 7SN, UK.
Tel: +44 (0)1527 516060 Fax: +44 (0)1527 526060
E.mail: lockmaster@wbh.co.uk
Website: www.wbh.co.uk

Certificate No:FM 35684



BS EN ISO 9001: 2000



A Metalrax Group PLC company