

# L-Series

## CIRCUIT BREAKER

The L-Series high performance, compact hydraulic-magnetic circuit breaker is ideally suited for the rigors and confined spaces found in today's telecom/datacom power distribution units and rack systems. It provides best in class performance in an innovative low profile, space saving package complementing the overall spatial objectives required by telecommunications and data-communications systems designers in their quest to reduce the overall size of equipment, while increasing transmission capacity.

The optional current transformer allows outlet metering and monitoring of power usage thus facilitating load adjustments and maximizing efficiency. Further, a patent pending flush rocker actuator design and optional push-to-reset guard offers additional protection against accidental switching.

Number of poles: 1-3. Maximum current and voltage ratings: .2-32A, 120/240-240VAC. Maximum interrupting capacity: 5000 Amps.



### Resources:

[Download 3D CAD Files](#)



[Watch Product Video](#)



### Product Highlights:

- Optional current transformer
- Ultra low profile design saves valuable space
- Optional handle guard actuator
- UL 489 LISTED Branch Circuit breaker
- Designed for worldwide datacenter compatibility with up to 240VAC ratings

### Typical Applications:

- Telecom/Datacom



**Carling Technologies™**

Innovative Designs. Powerful Solutions.

**Carling Technologies, Inc.**  
60 Johnson Avenue, Plainville, CT 06062  
Email: [sales@carlingtech.com](mailto:sales@carlingtech.com)  
Application Support: [team2@carlingtech.com](mailto:team2@carlingtech.com)  
Phone: 860.793.9281 Fax: 860.793.9231

[www.carlingtech.com](http://www.carlingtech.com)

# L-Series Circuit Breaker

## DESIGN FEATURES

### 1-Pole Configuration with Low Profile Rocker Actuator

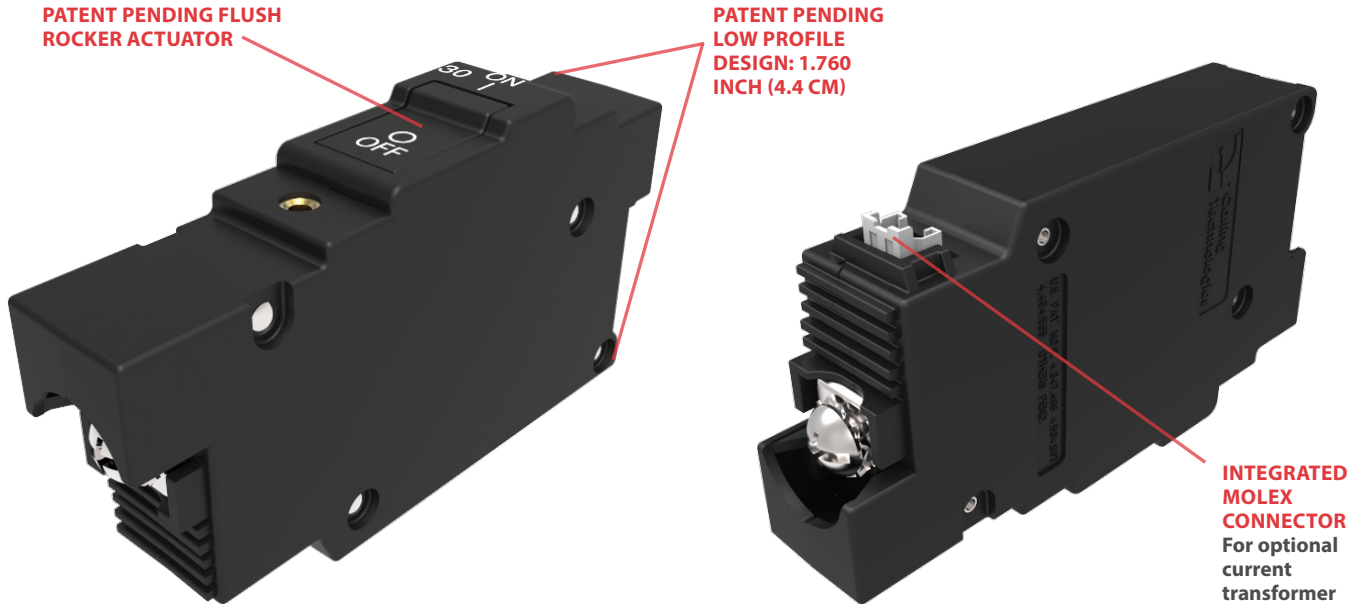

### 2-Pole Configuration with Push-To-Reset Guard

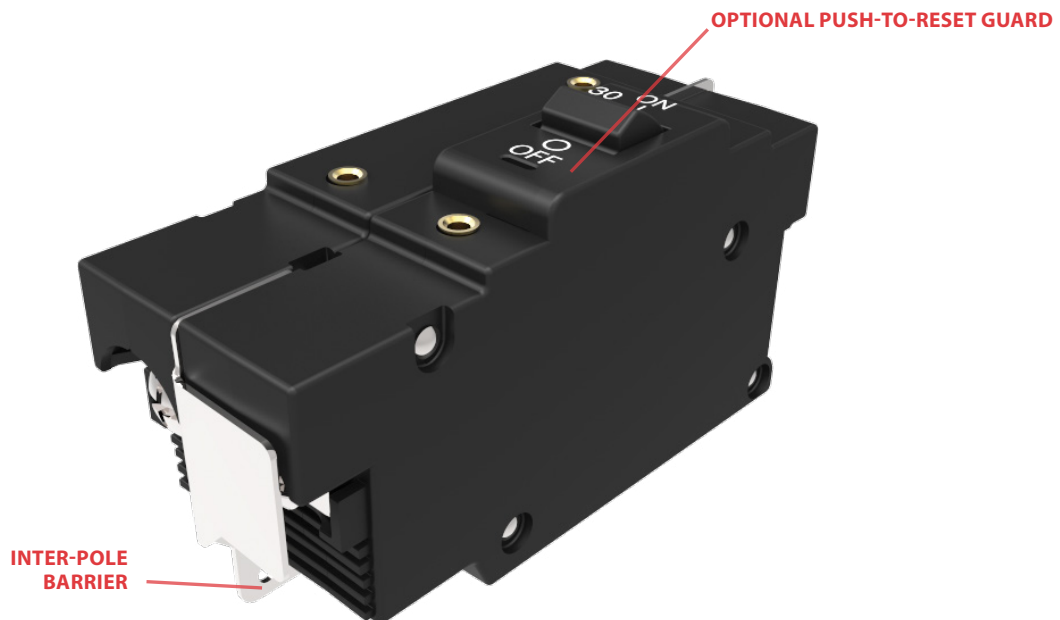

## Electrical Tables

Voltage, Current and IC Ratings

Voltage (VAC)	Current (Amps)	Number of Poles	Phase	Current Metering	Interrupt Capacity		
					UL489 (Amps)	EN60934	
						Icn	Inc
240	0.1 - 32	1	1	Yes	5000	3000	10000
240	0.1 - 32	2*	1	Yes	5000	3000	10000
240	0.1 - 20	3	3	Yes	5000	3000	5000
415/240	0.1 - 20	3	3	Yes	---	3000	5000
120/240	0.1 - 32	2	1	Yes	5000	3000	10000
120/240	0.1 - 32	3**	1	Yes	5000	3000	10000

Notes:

\* Breaking both sides of the line

\*\* 3<sup>rd</sup> pole to be neutral break

Time Delay

Delay Curve Number	Voltage	Description
21	50/60 Hz	Ultrashort
22	50/60 Hz	Short
24	50/60 Hz	Medium
26	50/60 Hz	Long
42	50/60 Hz	Hi-inrush, Short
44	50/60 Hz	Hi-inrush, Medium
46	50/60 Hz	Hi-inrush, Long

Impedance

RESISTANCE, IMPEDANCE VALUES  
from Line to Load Terminals

(Values Based on Series Trip Circuit Breaker)

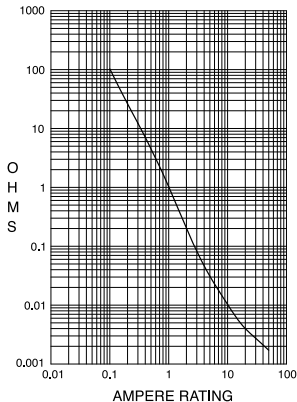

Current (amps)	Tolerance (%)
0.1-5.0	+/-15
5.1-32.0	+/-25

\*Manufacturer reserves the right to change product specification without prior notice.

## Electrical

### Current Metering

Integrated current transformer.  
 Measurement range: 1-32 Amps  
 Voltage output: 10mV per Amp  
 according to the formula below:  
 $2(\text{Amp}) \leq I \leq 32(\text{Amp})$   
 $V = 0.01 \times I \pm 2\%$

$$\left| \frac{\frac{V}{I} - \frac{V_{10}}{I_{10}}}{\frac{V_{10}}{I_{10}}} \right| \leq 0.85\%$$

Where V=CT output in volts V10=CT output in volts with I=I10=10 (A); I=primary current in amperage (50/60 Hz). Phase shift between primary current and CT output is  $0.25 \pm 0.25^\circ$ . Maximum crest factor of primary current is 1.73.

R1 shall be integrated in the breaker. R2 and R3 are provided by end user and external to the breaker. Connection: below Load Terminal. 2-pin connector, Molex 35362-0250. Mating Connector housing – Molex PN35507-0200. Dielectric Strength UL, CSA-1960V 50/60 Hz for one minute between all electrically isolated terminals. Comply with the 8mm spacing and 3750V 50/60 Hz dielectric requirements from hazardous voltage to operator accessible surfaces and between main circuits of adjacent poles per Publications EN 60950 and VDE 0805

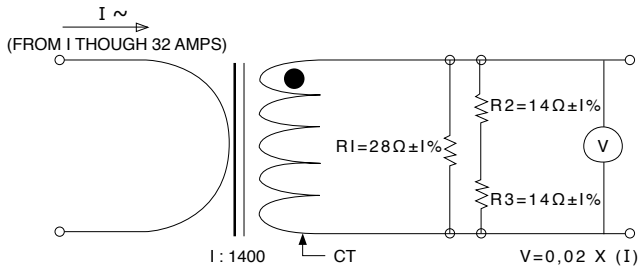

Insulation Resistance Minimum of 100 Megohms@500VDC  
 Overload 50 operations @ 600% of rated  
 Interrupt Capacity See Table 1

## Environmental

Environmental  
 Operating Temp  
 Vibration

MIL-PRF-55629 and MIL-STD-202G  
 -40°C to +85 °C  
 Withstands 0.06” excursion from 10-55 Hz and 10Gs 55-500 Hz at rated current per MIL-PRF-55629 and MIL-STD-202G, Method 204D, Test Condition A. Instantaneous and ultra-short curves tested at 90% of rated current.

Shock  
 Withstands 100 Gs, 6 ms saw tooth while carrying rated current per MIL-PRF-55629 and MIL-STD-202G, Method 213B, Test Condition “I”. Instantaneous and ultra short curves tested at 90% of rated current.

Thermal Shock  
 MIL-PRF-55629 and MIL-STD-202G, Method 107G, Condition A (5-cycles at -55°C to +25°C to +85°C to +25°C).

Moisture Resistance  
 MIL-PRF-55629 and MIL-STD-202G, Method 106G, i.e., Ten 24-hour cycles at +25°C to +65°C, 80-98% RH.

Salt Spray  
 Method 101, Condition A (90-95% RH @ 5% NaCl Solution, 96hrs)

## Physical

Number of Poles 1-3 poles  
 Termination Screw Terminals with the following thread sizes: 10-32, 8-32, M5, M4  
 Termination Barrier Standard for 2 & 3 poles  
 Mounting Threaded Insert: #6-32 UNC-2B, or M3X0.5-6H B ISO (2 per Pole)  
 Actuator Rocker, with or without guard  
 Internal Circuit Config. Series Trip  
 Materials Housing - Glass Filled Polyester  
 Rocker – Nylon 6/6  
 Line/Load Terminals – Copper Alloy; Bright Acid Tin Plated  
 Weight ~107 Grams (~3.76 Ounces) per pole  
 Standard Color Housing - Black, Rocker - Black

## Mechanical

Endurance 10,000 “On-Off” Operations @ 6 per minute; 6000 cycles with rated Current and Voltage; 4000 cycles without electrical load.  
 Trip Free Trips on overload even when actuator is forcibly held in the “On” position.  
 Trip Indication The operating actuator moves positively to the “Off” position when an overload causes the breaker to trip

\*Manufacturer reserves the right to change product specification without prior notice.

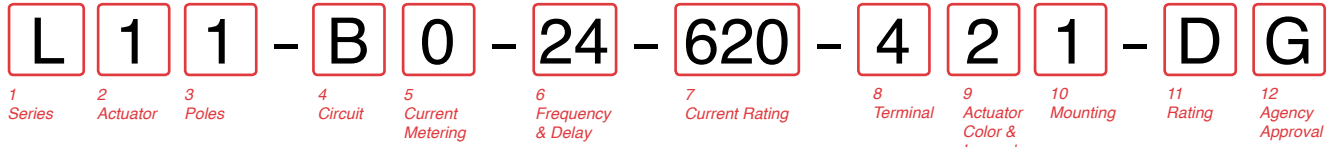

**1 SERIES**  
L

- 2 ACTUATOR**
- 1 Single Color Low Profile Rocker, Vertical Legend
  - 2 Single Color Low Profile Rocker, Horizontal Legend
  - 3 Single Color Push to Reset Low Profile Rocker, Vertical Legend
  - 4 Single Color Push to Reset Low Profile Rocker, Horizontal Legend

- 3 POLES**
- 1 One
  - 2 Two
  - 3 Three

- 4 CIRCUIT**
- B Series Trip (current)

- 5 CURRENT METERING**
- 0 Without Current Transformer
  - 1<sup>2</sup> Integrated Current Transformer, 1 per unit
  - 2 Integrated Current Transformer, 1 per pole

- 6 FREQUENCY & DELAY**
- 21 50/60Hz Ultra Short
  - 22 50/60Hz Short
  - 24 50/60Hz Medium
  - 26 50/60Hz Long
  - 42 50/60Hz Short, Hi-Inrush
  - 44 50/60Hz Medium, Hi-Inrush
  - 46 50/60Hz Long, Hi-Inrush

**7 CURRENT RATING (AMPERES)**

CODE	AMPERES	CODE	AMPERES	CODE	AMPERES
210	0.100	415	1.500	610	10.000
215	0.150	517	1.750	710	10.500
220	0.200	420	2.000	611	11.000
225	0.250	522	2.250	711	11.500
230	0.300	425	2.500	612	12.000
235	0.350	527	2.750	712	12.500
240	0.400	430	3.000	613	13.000
245	0.450	435	3.500	614	14.000
250	0.500	440	4.000	615	15.000
255	0.550	445	4.500	616	16.000
260	0.600	450	5.000	617	17.000
265	0.650	455	5.500	618	18.000
270	0.700	460	6.000	620	20.000
275	0.750	465	6.500	622	22.000
280	0.800	470	7.000	624	24.000
285	0.850	475	7.500	625	25.000
290	0.900	480	8.000	630	30.000
295	0.950	485	8.500	632	32.000
410	1.000	490	9.000		
512	1.250	495	9.500		

- 8 TERMINAL**
- 2 Screw Terminal, 8-32 (Bus Type)
  - 4 Screw Terminal, 10-32 (Bus Type)
  - E Screw Terminal, M4 (Bus Type)
  - H Screw Terminal, M5 (Bus Type)

**9 ACTUATOR COLOR & LEGEND**

Actuator Color	I-O	ON-OFF	Dual	Legend Color
White	A	B	1	Black
Black	C	D	2	White
Red	F	G	3	White
Green	H	J	4	White
Blue	K	L	5	White
Yellow	M	N	6	Black
Gray	P	Q	7	Black
Orange	R	S	8	Black

- 10 MOUNTING INSERTS<sup>3</sup>**
- 1 6-32 X .195 Threaded Inserts
  - A 6-32 X .195 Threaded Inserts with Terminal Barrier
  - 2 ISO M3 X 5 mm Threaded Inserts
  - B ISO M3 X 5 mm Threaded Inserts with Terminal Barrier

- 11 MAX. APPLICATION RATING**
- C<sup>1</sup> 120/240 VAC (2 or 3 Pole only)
  - D 240 VAC
  - P<sup>4</sup> 415Y/240 VAC (TUV only) 240 VAC 3 phase Delta

- 12 AGENCY APPROVAL**
- A Without approvals
  - G UL 489 Listed
  - 3 UL 489 Listed, TUV Certified

Notes:

- 1 3 Pole units available only when one of three poles is neutral
- 2 On Multi Pole units one current transformer is supplied on the actuator pole
- 3 Terminal barriers are required on multi poles breaker
- 4 Voltage rating P only available as a 3 pole device 20A max

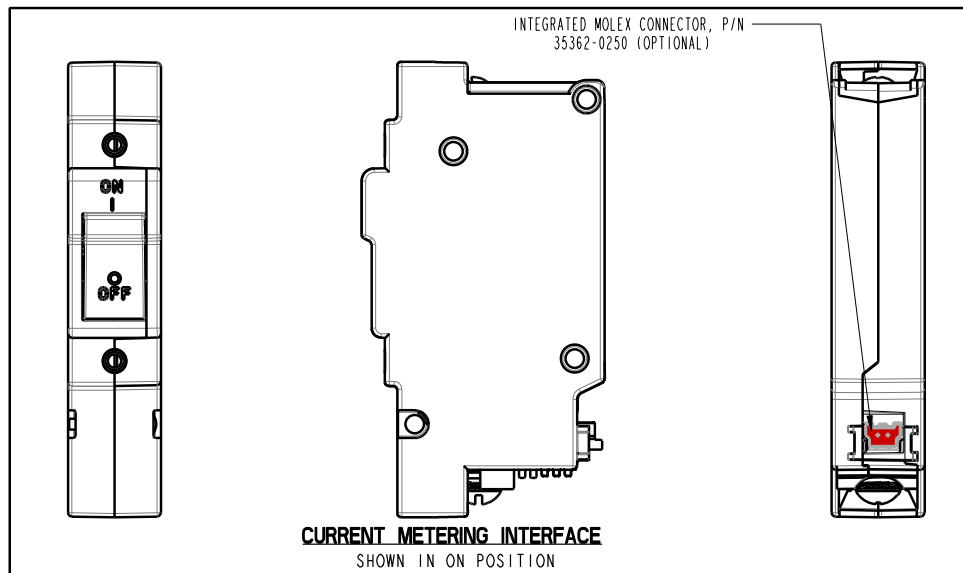
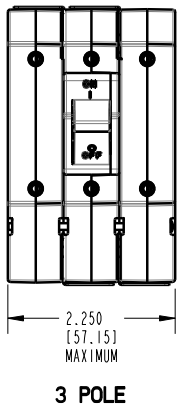
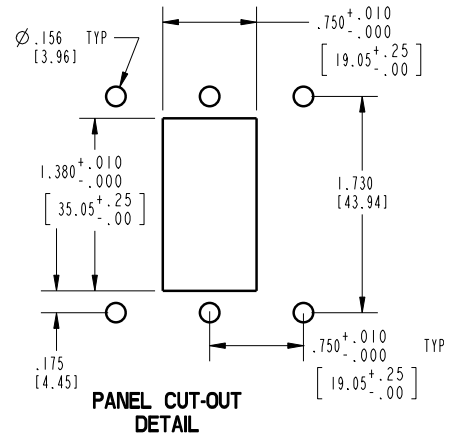
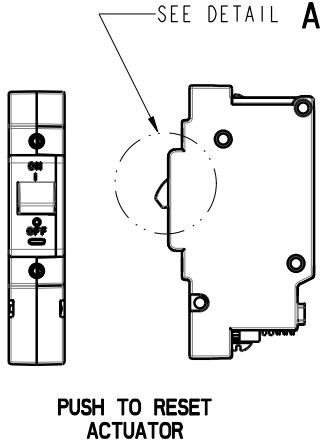
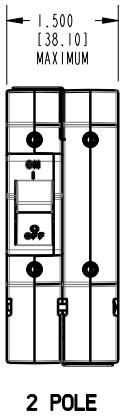
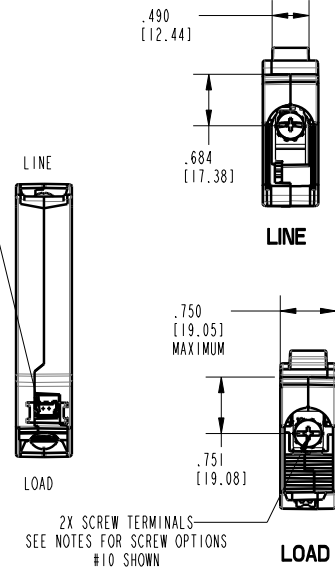
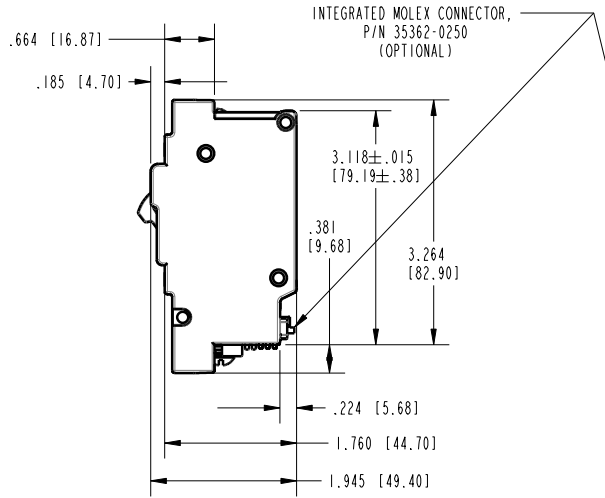
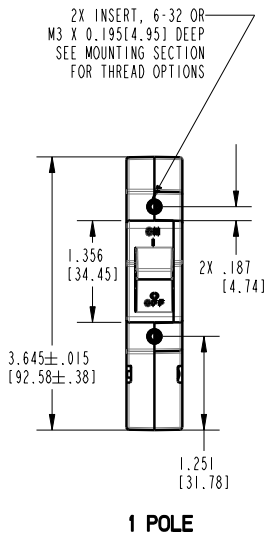

NOTES:  
1. SCREWS HAVE COMBINATION HEAD  
2. SCREW THREAD OPTIONS: #8-32, #10-32, MAX.7, M5X.8

**Ultrashort - AC**

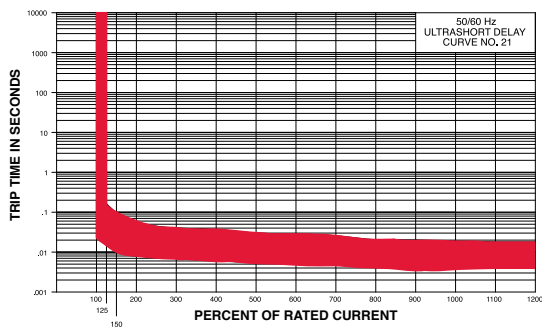

**Short - High Inrush AC**

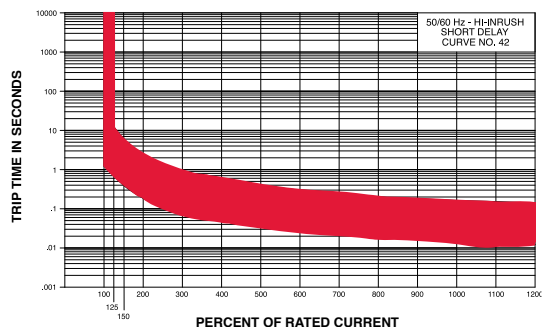

**Short - AC**

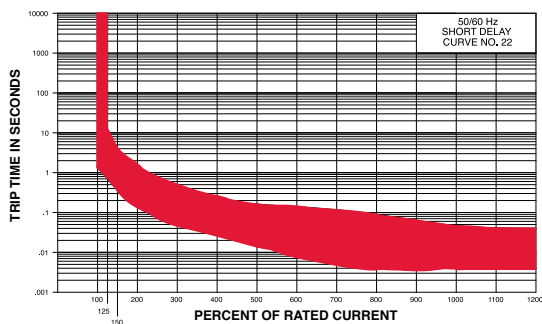

**Medium - High Inrush AC**

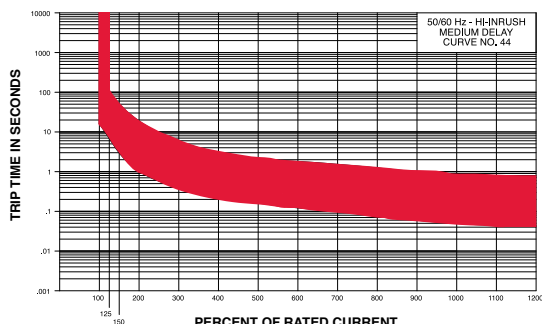

**Medium - AC**

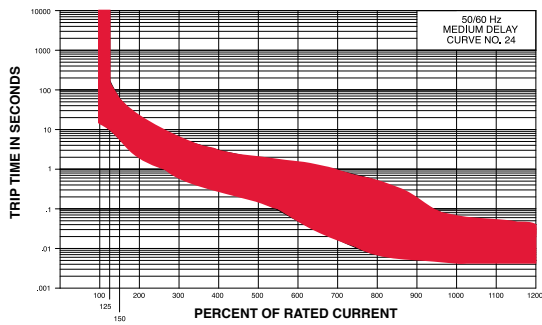

**Long - High Inrush AC**

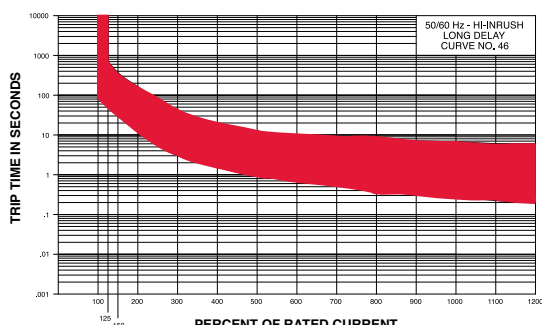

**Long - AC**

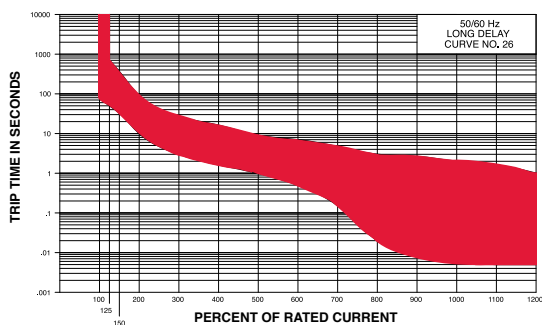

### Authorized Sales Representatives

Click on the group name on the map below to find your local representative or visit [www.carlingtech.com/findarep](http://www.carlingtech.com/findarep).

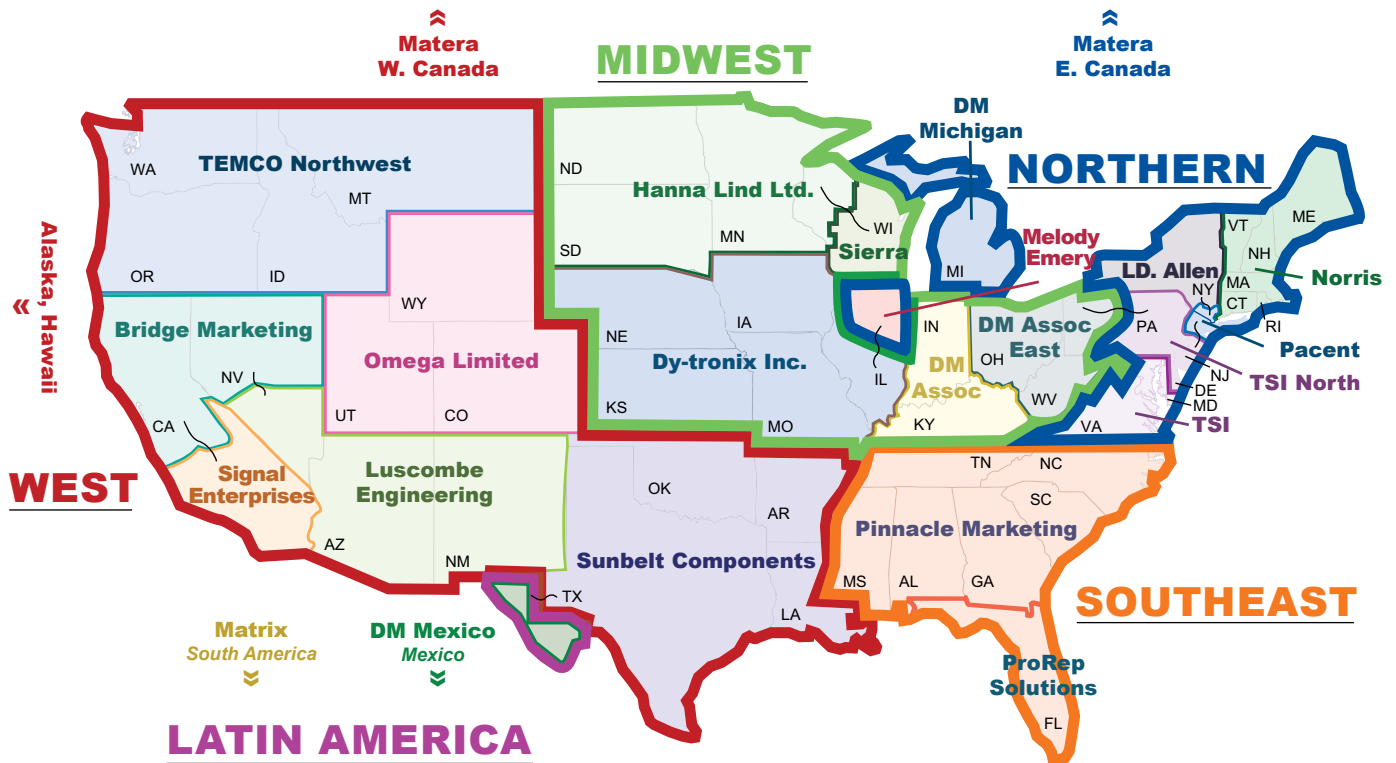

### About Carling

Founded in 1920, Carling Technologies is a leading manufacturer of electrical and electronic switches and assemblies, circuit breakers, electronic controls, power distribution units, and multiplexed power distribution systems. With four ISO registered manufacturing facilities and technical sales offices worldwide, Carling Technologies Sales, Service and Engineering teams do much more than manufacture electrical components, they engineer powerful solutions! To learn more about Carling please visit [www.carlingtech.com/company-profile](http://www.carlingtech.com/company-profile).

To view all of Carling’s environmental, quality, health & safety certifications please visit [www.carlingtech.com/environmental-certifications](http://www.carlingtech.com/environmental-certifications)





## **Worldwide Headquarters**

Carling Technologies, Inc.  
60 Johnson Avenue, Plainville, CT 06062  
**Phone:** 860.793.9281 **Fax:** 860.793.9231  
**Email:** sales@carlingtech.com

**Northern Region Sales Office:** nrsm@carlingtech.com  
**Southeast Region Sales Office:** sersm@carlingtech.com  
**Midwest Region Sales Office:** mrrsm@carlingtech.com  
**West Region Sales Office:** wrsm@carlingtech.com  
**Latin America Sales Office:** larsm@carlingtech.com

## **Asia-Pacific Headquarters**

Carling Technologies, Asia-Pacific Ltd.,  
Kowloon, Hong Kong  
**Phone:** Int + 852-2737-2277 **Fax:** Int + 852-2736-9332  
**Email:** sales@carlingtech.com.hk

**Shenzhen, China:** shenzhen@carlingtech.com  
**Shanghai, China:** shanghai@carlingtech.com  
**Pune, India:** india@carlingtech.com  
**Kaohsiung, Taiwan:** taiwan@carlingtech.com  
**Yokohama, Japan:** japan@carlingtech.com

## **Europe | Middle East | Africa Headquarters**

Carling Technologies LTD  
4 Airport Business Park, Exeter Airport,  
Clyst Honiton, Exeter, Devon, EX5 2UL, UK  
**Phone:** Int + 44 1392.364422 **Fax:** Int + 44 1392.364477  
**Email:** ltd.sales@carlingtech.com

**Germany:** gmbh@carlingtech.com  
**France:** sas@carlingtech.com



**Carling Technologies™**

Innovative Designs. Powerful Solutions.