

IDEX
FLUID & METERING

AirVantage®

ENERGY SAVING TECHNOLOGY

SAVE Energy • **SAVE** Compressor Cost • **SAVE** Operator Cost



Redefining Performance

- Reduces air consumption up to 50%
- Adapts to process conditions
- Powered only by compressed air
- Saves energy while maintaining flow†
- Increases productivity
- Reduces compressor maintenance



No Manual Setting!

- Auto adjusts to your process conditions



No Wiring or Batteries!

- Self contained 12V power generator

US Patent # 7,521,921.
Other Patents Pending

BLAGDON
PUMP®

WWW.BLAGDONPUMP.COM

The AirVantage® Difference

Energy Saving Technology

AirVantage is a new technology for Air Operated Double Diaphragm pumps that significantly reduces air consumption over conventional AODD pumps.

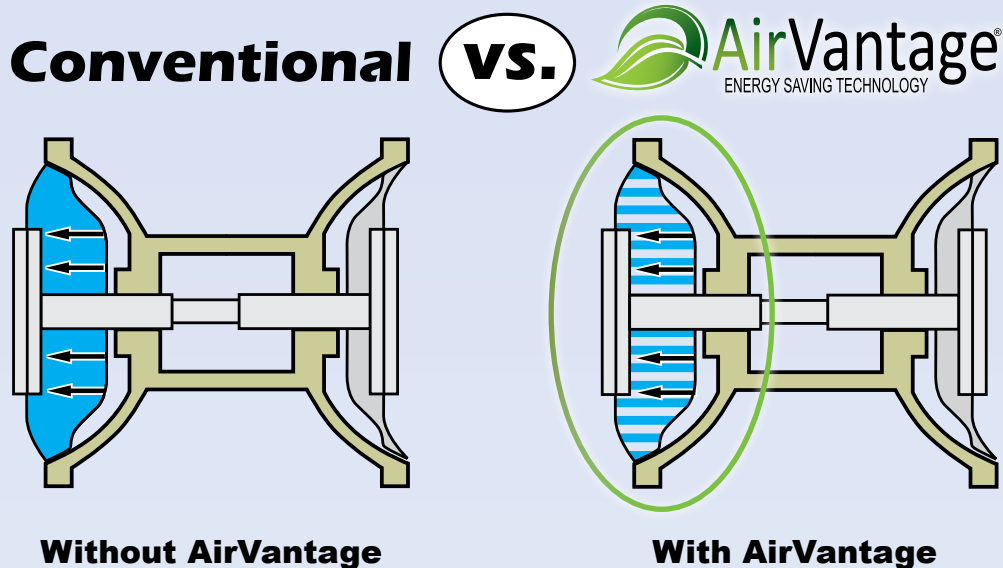

Without AirVantage
Conventional AODD pumps fully expand diaphragms to complete pump stroke, causing increased air usage and expense.

With AirVantage
AirVantage uses advanced technology to complete full diaphragm expansion using up to 50% less air while maintaining flow.

Benefits of AirVantage

- **Reduces air consumption**
 - Field testing shows up to 50% savings over conventional AODD pumps. AirVantage Technology is available with BLAGDON® metallic pumps with discharge line sizes of 2" or greater. BLAGDON center section upgrade kits are also available.
- **Adapts to process conditions**
 - Using an advanced learning program that receives velocity feedback from an embedded sensor, AirVantage optimizes energy consumption and automatically adapts to changes in system demand, constantly managing energy consumption.
- **Powered only by compressed air**
 - AirVantage uses a self-contained 12V power generator that converts a tiny portion of compressed air to power system electronics for managing energy.
- **Saves energy while maintaining flow**
 - Field trials have proven that AirVantage can maintain comparable flow capacity while reducing air consumption saving thousands of dollars in annual energy costs.
- **Increases productivity**
 - By using less air to operate pumps, AirVantage allows for more compressed air capacity system-wide to run more pumps generating greater productivity and better throughput.
- **Reduces compressor maintenance**
 - Air compressors with reduced demand need fewer repairs, saving customers thousands of dollars in maintenance and repair parts.

†: Maintains plus or minus 5% flow variation

How AirVantage® Works

Energy Saving Technology

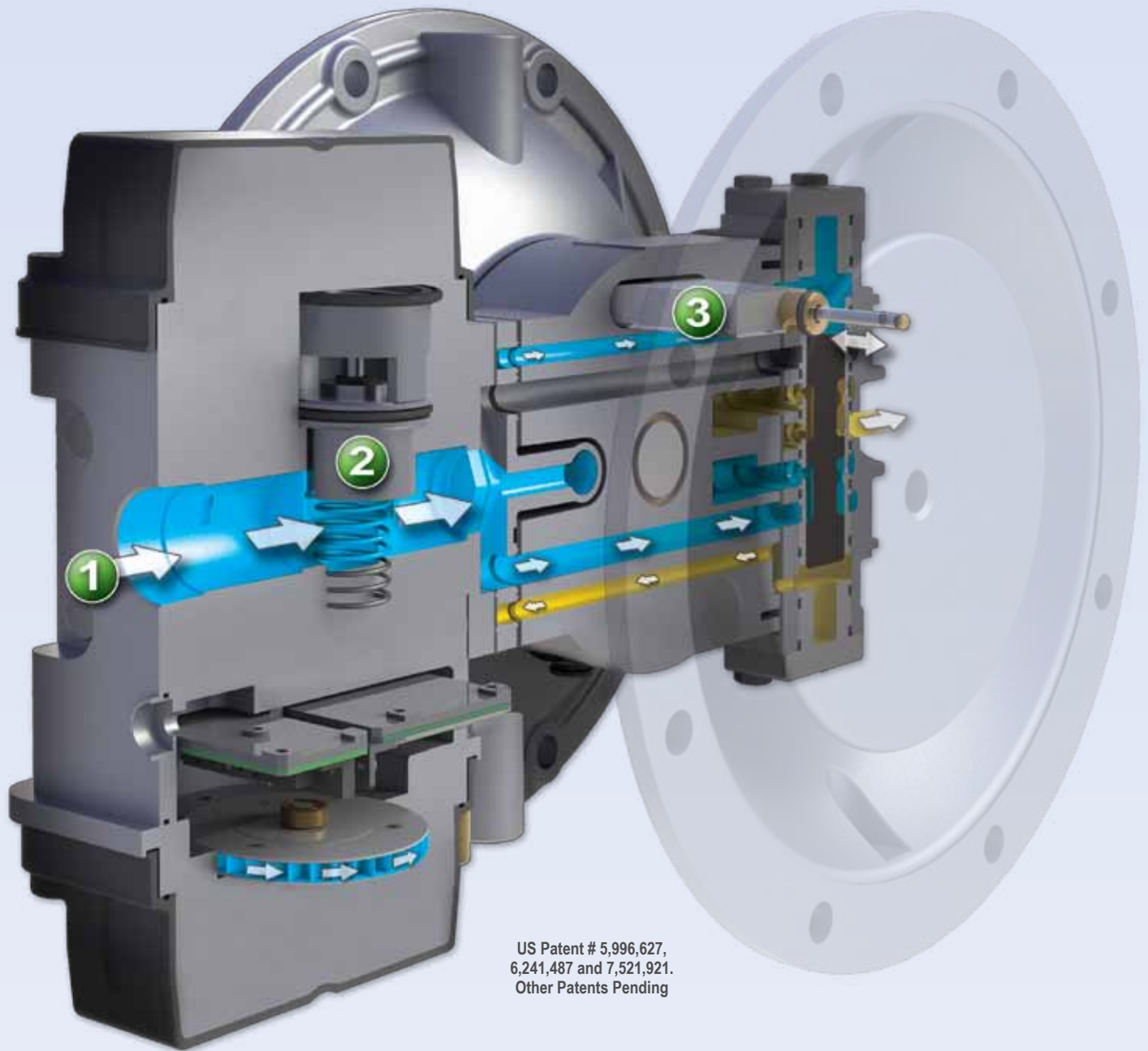

US Patent # 5,996,627,
6,241,487 and 7,521,921.
Other Patents Pending

Step 1

- Air enters main inlet.
- Small amount of air directed to turbine that powers the unit.

Step 2

- Air Regulator Valve controls air flow volume.
- Air continues on standard path through air system.

Step 3



- Sensor monitors pump velocity, sends data to microprocessor.
- Microprocessor calculates ideal air usage, regulates air valve.

AirVantage® Components

Energy Saving Technology



AirVantage Components

- **Air Regulator Control**
Contains PowerGen regulator and electro/pneumatic SMC pilot valve.
- **Mechanical Valve**
Opens and partially closes as directed by the Velocity Feedback System to save air while maintaining flow.
- **Velocity Feedback System**
Advanced learning program modulates air flow to optimize energy usage. Automatically adapts to changing process conditions. Green LED light is a diagnostic tool and indicates proper operation.
- **On/Off Switch**
On/Off switch allows the operator to measure air consumption with or without AirVantage once the pump goes on-line. AirVantage defaults to standard pump performance when in "off" mode.
- **PowerGen**  
Self contained 12V PowerGen module generates power for system using existing air. No need to run electrical or replace batteries.

US Patent #
5,996,627,
6,241,487 and
7,521,921.
Other Patents
Pending

Certified Best in Class



Member of:
Hydraulic
INSTITUTE



Let us show you how much
you can save with our
FREE 30-day trial in your facility.

Receive a complete test report.

AirVantage® vs. Competition

Energy Saving Technology

Annual Savings

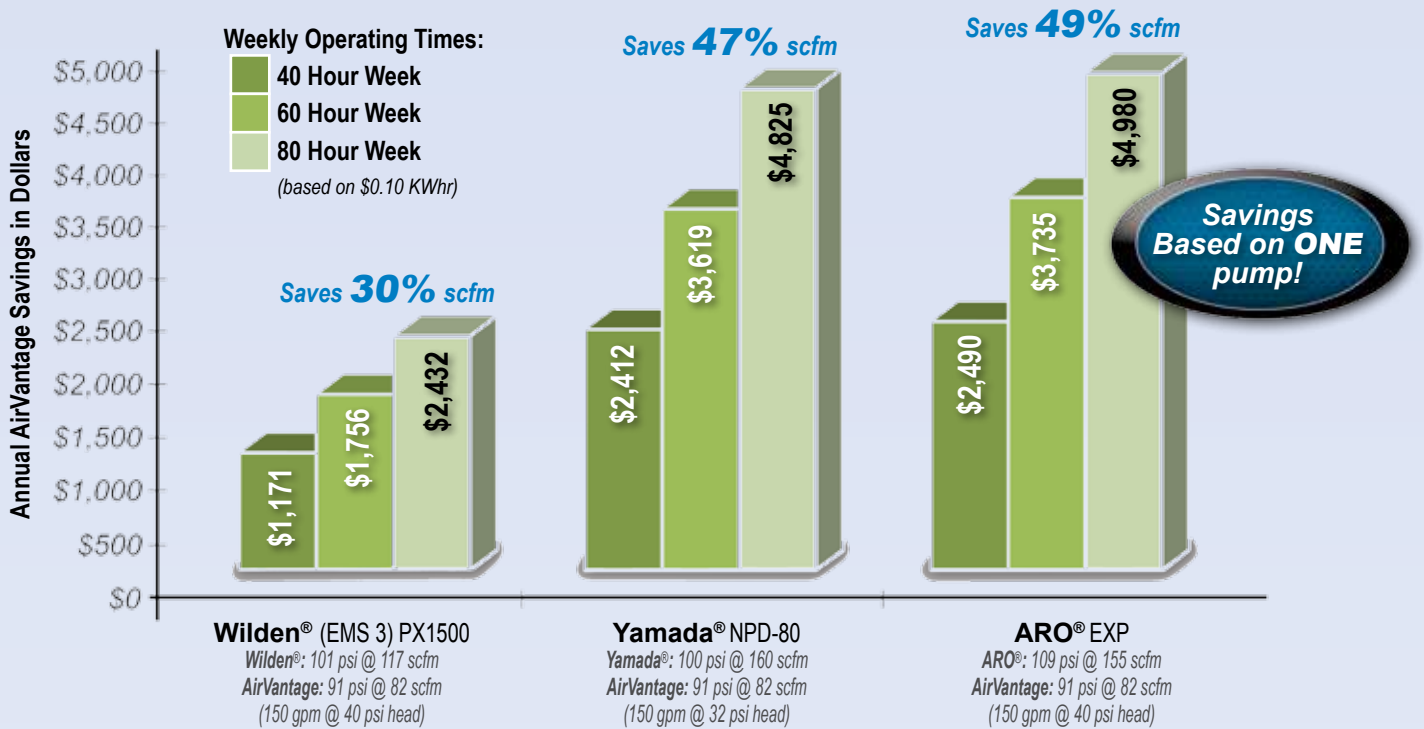

*Comparisons made from published data

Wilden® is a registered trademark of Wilden Pump & Engineering Company a Dover Resources Company
 ARO® is a registered trademark of Ingersoll-Rand Company • Yamada® is a registered trademark of Yamada Corporation

AirVantage Saves More Than Energy

BLAGDON AirVantage vs. Standard Pump

Ways You Save with AirVantage	50% Energy Savings	25% Energy Savings
1. Energy Savings (20-50%)	\$3,000	\$1,500
2. Less Energy Draw From Compressor Systems • Avoid buying additional air compressor	\$25,000	\$25,000
3. Reduced Air Compressor Maintenance Expense • 50% annually, including spare parts	\$2,500	\$1,250
4. Reduced Pump Maintenance & Operating Costs	\$1,750	\$1,750
5. Reduced Decibel Levels 8-10% • Based on single OSHA violation expense	\$1,500	\$1,500
Total Value Calculated	\$33,750	\$31,000
Total Value minus Air Compressor	\$8,750	\$6,000

In addition to saving energy, these are some examples of how AirVantage can add value to your overall operation:

- When AODD pumps require less energy for operation, there is lower demand for compressed air throughout the facility.
- Lower air compressor demand reduces annual repair parts and maintenance costs.
- Because AirVantage is self-adapting, less time is spent monitoring and manually adjusting the air-valve settings for optimizing energy consumption.
- AirVantage also operates at lower decibel levels, making for a safer work environment.

Results may vary: • Estimates shown are based on a 3" size pump, operating at 40 hours per week using \$.10/KWhr
 • Average factory air compressor maintenance costs estimated to be \$5,000 on repair parts and labor.

AirVantage® ATEX Certified

Energy Saving Technology



with Hazardous Certified Option

Hazardous Certified Option

AirVantage is the only electronic air savings device in the world that is certified for hazardous locations. The ATEX Certified option is rated explosion proof and has passed both ATEX and UL/CSA standards for hazardous duty applications.

Improved Characteristics:

- ATEX valve housing armor to meet explosion-proof guidelines
- Recessed on-off switch with ATEX safety plug
- Static-free borosilicate glass LED lens cover
- Intrinsically Safe electrical fittings for ATEX compliant cables and glands
- ATEX approved circuitry

Definitions:

ATEX: **AT**mospheres **EX**plosibles, European Standard for equipment certified safe to be used in potentially hazardous environments.

UL/CSA: Underwriters Laboratory/Canadian Standards Association, North American standards for equipment certified safe to be used in potentially hazardous environments.

Explosion Proof: Pump prevents transmission of internal explosions by enclosing parts that could ignite the surrounding atmosphere.

Hazardous Duty: Term for our ATEX certified pumps.

AirVantage Applications

Industries:

- Chemical / Petrochemical Processing
- Ceramic Glaze / Slip Processing
- Paints, Inks and Coatings
- Pulp and Paper Converters
- Adhesives Processing
- Industrial / Municipal Wastewater
- Construction / Utilities

Typical Applications & Usage:

Characteristics:	Application Type:	Description:
Long Hours of Operation	Recirculation, Mixing, Batching	Long hours of continuous operation consume the most energy. Small improvements in air consumption make huge impact on bottom line
High SCFM Consumption	Transfer, Loading, Offloading	Opportunities to reduce highest percentage of SCFM consumption
High Air Compressor Costs	Facility air capacity is at a premium	Reducing between 3-7 HP per pump can make a significant difference to compressor operation. (ex: 40 pumps x 5HP = 200 HP reduction)
Hazardous Duty ATEX Certified	Recirculation, Mixing, Batching, Transfer, Loading, Offloading, and Processing	Paints, Solvents, Fuels, Acids, and Hazardous Chemicals

AirVantage® Testimonial

Energy Saving Technology

Saint Gobain • Niagara Falls, NY

See how AirVantage is saving customers money and how it works for them. If you need more proof take our FREE 30-day Trial Challenge and get the exact numbers for your facility.



Saint Gobain Statistics:

Industry: **Construction Materials**

Compressor Gain: **2.5 HP per pump**

Energy Reduction: **23%**

Annual Energy Savings: **\$1,200**



*“At Saint Gobain, we took the 30-Day Energy Savings Challenge within our facility and **reduced our energy cost by 23%** at our fluid separation point.*

*Fluid separation points at Saint Gobain are the most process-critical applications within our facility. They serve multiple functions, including recirculation and batch transfer. They run 24 hours a day, seven days a week. Over this period of time, AirVantage™ reduced our air consumption by 23% **while maintaining our desired flow rates.***

*It was simple. All we did was install the trial AirVantage™ pump and it did the rest, **optimizing our energy consumption without special handling or monitoring.** As the pump application switched from batch transfer to recirculation to fluid separation, the AirVantage™ self-adjusted to the pressure drops and changing condition-points all by itself, using just the right amount of compressed air to operate our pump.*

*At the end of the product trial, test results showed the amount of compressed air the pump consumed with AirVantage™ versus data points collected prior to the product trial. We were surprised to learn that we can save as much as **\$1,200 in energy costs and increase our air compressor capacity by 2.5 HP per pump.***

We were very satisfied with the performance of the new system, and we plan to use AirVantage™ on all AODD pumps in the future.”

Rick Klok
Plant Manager
Grains and Powders Manufacturing Facility
Saint Gobain • Niagara Falls, NY

AirVantage® 3" AVB75

Energy Saving Technology



AVB75

- AirVantage
- All bolted construction
- Side discharge
- Ball check valves
- Durable diaphragm connecting rod
- Light weight - portable
- 90° - 180° manifold connection rotation
- Solids range +.25" (6mm) to .38" (9.65mm)
- Dry primes up to 20 feet of water
- Complete center section upgrade kits available

Curve: AVB75

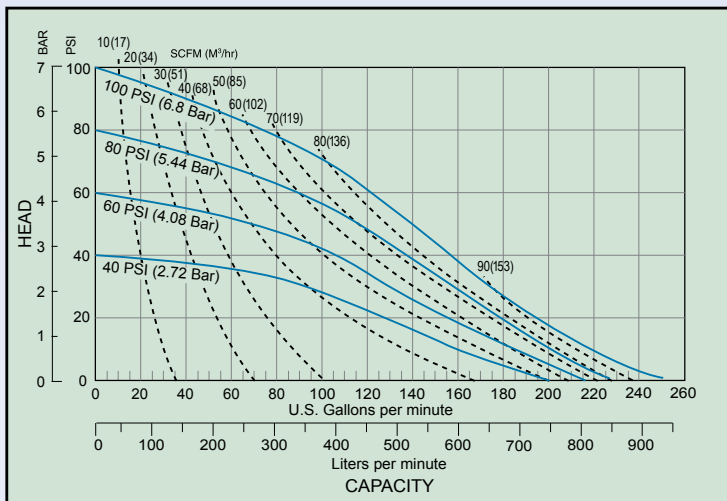

Performance based on the following: elastomer fitted pump, flooded suction, water at ambient conditions. The use of other materials and varying hydraulic conditions may result in deviations in excess of 5%.

Characteristics:		Standard Duty AirVantage
Fluid Characteristics	Water (base reference)	Best Type
	Suspended Solids	Best Type
	Non-Suspended Solids	Limitations
	Line Size Solids	Unsuitable
	Sludge / Slurry	Suitable
	High Viscosity (Flowable Fluids)	Suitable
	Erosion / Abrasive Fluids - High	Suitable
	Erosion / Abrasive Fluids - Moderate	Suitable
	Erosion / Abrasive Fluids - Low	Best Type
Corrosion	Suitable	
Installation	Permanent	Suitable
	Portable	Best Type
	Containment / Prevention	Limitations
	Flooded Suction	Suitable
	Suction Lift	Suitable
	Submerged	Suitable
Duty	Intermittent / On-Demand	Best Type
	Continuous	Suitable

Pump Model	Pump Design	Pipe Size		Capacity		Air Valve: No-lube, No-stall Guarantee	Solids Handling Up to		Heads - Up to				Displacement per Stroke	
		Intake	Discharge	GPM	LPM		Inch	MM	PSI	ft. of Water	BAR	M	Gallon	Liter
AVB75	Standard Duty	3" (internal)	3" (internal)	0-235	0-889	Yes	.38	9.65	125	289	8.6	88	1	3.78

AirVantage® 3" AVX75 - ATEX Certified

Energy Saving Technology



AVX75



Same as Model AVB with added Hazardous Duty and ATEX Certifications.

- ATEX valve housing armor to meet explosion-proof guidelines
- Recessed on-off switch with ATEX safety plug
- Static-free borosilicate glass LED lens cover
- Intrinsically Safe electrical fittings for ATEX compliant cables and glands
- ATEX approved circuitry

Curve: AVX75

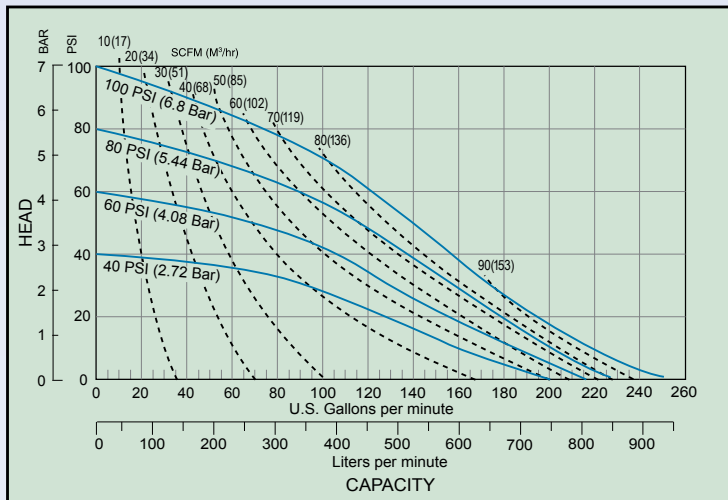

Performance based on the following: elastomer fitted pump, flooded suction, water at ambient conditions. The use of other materials and varying hydraulic conditions may result in deviations in excess of 5%.

Characteristics:		Standard Duty AirVantage
Fluid Characteristics	Water (base reference)	Best Type
	Suspended Solids	Best Type
	Non-Suspended Solids	Limitations
	Line Size Solids	Unsuitable
	Sludge / Slurry	Suitable
	High Viscosity (Flowable Fluids)	Suitable
	Erosion / Abrasive Fluids - High	Suitable
	Erosion / Abrasive Fluids - Moderate	Suitable
	Erosion / Abrasive Fluids - Low	Best Type
Corrosion	Suitable	
Installation	Permanent	Suitable
	Portable	Best Type
	Containment / Prevention	Limitations
	Flooded Suction	Suitable
	Suction Lift	Suitable
	Submerged	Suitable
Duty	Intermittent / On-Demand	Best Type
	Continuous	Suitable

Pump Model	Pump Design	Pipe Size		Capacity		Air Valve: No-lube, No-stall Guarantee	Solids Handling Up to		Heads - Up to			Displacement per Stroke		ATEX Certified Option	
		Intake	Discharge	GPM	LPM		Inch	MM	PSI	ft. of Water	BAR	M	Gallon		Liter
AVX75	Standard Duty	3" (internal)	3" (internal)	0-235	0-889	Yes	.38	9.65	125	289	8.6	88	1	3.78	Yes

AirVantage® Center Section Upgrades

Energy Saving Technology

Center Section Upgrades!

BLAGDON® AirVantage upgrade kits make it possible to upgrade your existing pumps without having to purchase a new one.

Improve your pumps efficiency while saving on:

- Acquisition cost
- Installation time
- Materials



B475.285.000



No Manual Setting!

- Auto adjusts to your process conditions



No Wiring or Batteries!

- Self contained 12V power generator

Construction Options: AirVantage AVB75 & AVX75

Diaphragm Material (temp range)	Wetted Material	Valve Material	Seat Material	Options
EPDM (280°F / -40°F, 138°C / -40°C)	Alloy C (Hastelloy® Equiv.)	EPDM	Aluminum	ATEX Certified
FKM (Fluorocarbon) (350°F / -40°F, 177°C / -40°C)	Aluminum	Neoprene	Carbon Steel	AirVantage: PowerGen or 110V electric plug-in
Neoprene (200°F / -10°F, 93°C / -23°C)	Cast Iron	Nitrile	EPDM	Kit: 10-30VDC Pulse Output Kit
Nitrile (190°F / -10°F, 88°C / -23°C)	Stainless Steel	PTFE	FKM	Kit: 110/120 or 220/240VAC Pulse Output Kit
Polypropylene (180°F / 32°F, 82°C / 0°C)		Santoprene®	Neoprene	Kit: Stroke Indicator Pins
Santoprene® (275°F / -40°F, 135°C / -40°C)			Nitrile	Porting: NPT Threads
Virgin PTFE (220°F / -35°F, 104°C / -37°C)			PTFE	Porting: BSP (Tapered) Threads
			Stainless Steel	Porting: Raised Face 150# Threaded ANSI Flange

Hastelloy® is a registered trademark of Haynes International, Inc. • Santoprene® is a registered tradename of Exxon Mobil Corp.

Optional Accessories:



Pulsation Dampeners

Maintains a constant air cushion volume for the most effective surge suppression.

MODEL #:
CONSULT FACTORY



Air Dryer

Removes 99% of the water, rust and other contaminants in compressed air lines.

MODEL#: 1/2": 020.047.000,
1": 020.048.008



Speed Control

Accurate control of variable flow rates with electric speed control system.

MODEL #: 110V: 032.022.000 220V:
032.023.000



AirVantage Validator

AirVantage Validator is used to measure air inlet pressure and pump air usage. Plumbs inline prior to the air inlet of pump.

MODEL#: METRIC: 475.282.000,
US: 475.274.000



Filter/Regulators

Clean, dry air optimizes AODD pump operation and reduces maintenance.

MODEL #:
20 MICRON: 070.020.000



FREE 30-DAY TRIAL

Take the AirVantage Challenge, contact your local BLAGDON distributor to schedule a **FREE** on-site analysis.

Only AirVantage goes beyond talking and shows you how much you can save by putting our pump in your facility for **FREE**.
Its as easy as 1-2-3.

1. Contact Your Local Distributor

- Tell them you want to take the FREE AirVantage Challenge.

2. Schedule a FREE Evaluation

- We install monitors on your system to evaluate current air consumption (SCFM).
- Then we install AirVantage and evaluate air consumption (SCFM).

3. Review your FREE Test Results

- Data from the on-site testing is presented in a comprehensive report.
- We review the report with you and show how AirVantage can save you money.
- We provide you with a savings estimate.



We install our monitor to your system and evaluate air consumption (SCFM). Then we install AirVantage and show you the results.

**MODEL#: METRIC: 475.282.000,
US: 475.274.000**

Distributed By:



This eco-friendly product is printed using soy-based inks on paper which is acid-free, contains 55% recycled content including 30% post-consumer waste, is bleached without using chlorine and the wood pulp is harvested from sustainable forests.



BLAGDON PUMP • R79 Shannon Industrial Estate • Shannon, Co. Clare, Ireland
Tel: +353 (0) 61 471933 • Fax: +353 (0) 61 475046 • E-mail: sales@blagdonpump.com • www.blagdonpump.com

©Copyright 2011 BLAGDON PUMP. All Rights Reserved.



blag_av_bro-rev0311