



M12 Automatisierungstechnik - Sonder - S-Kodierung

M12 Automation Technology - Special - S-Coding

Kabelsteckverbinder

- Schraubverriegelung nach DIN EN 61076-2-111
- Schutzart IP67 ¹⁾
- Einfache Montage
- 630 V/12 A
- Winkelsteckverbinder in 4 Positionen einstellbar

Flanschsteckverbinder

- Schraubverriegelung nach DIN EN 61076-2-111
- Schutzart IP67 ¹⁾
- Einfache Montage
- Litzen
- Verschiedene Bauformen

Cable Connectors

- Screw locking according to DIN EN 61076-2-111
- Degree of protection IP67 ¹⁾
- Easy assembly
- 630 V/12 A
- Angled connector adjustable in 4 positions

Panel Mount Connectors

- Screw locking according to DIN EN 61076-2-111
- Degree of protection IP67 ¹⁾
- Easy assembly
- Single wires
- Various variants

¹⁾Erläuterung der Schutzarten siehe technische Informationen./ ¹⁾Explanation of protection standards see technical information.

Kabelstecker mit S-Kodierung, Power
Male cable connector with S-coding, Power

Abbildung / Figure



Winkelstecker mit S-Kodierung, Power
Male angled connector with S-coding, Power



Maßzeichnung / Drawing

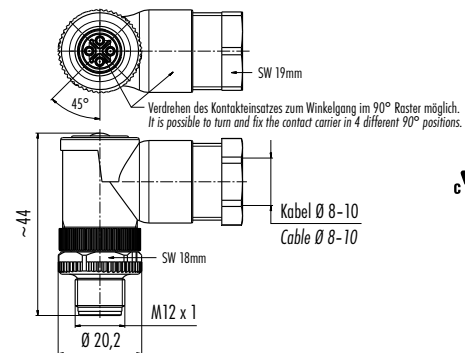
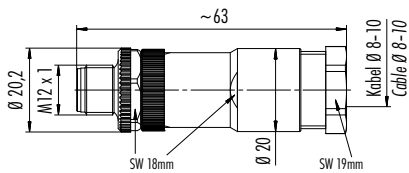

Bestell-Daten / Order Data

Polzahl Contacts	Kabeldurchlass Cable outlet	Bestell-Nr. Ordering-No.
3+PE	8-10 mm	99 0689 19 04

Polzahl Contacts	Kabeldurchlass Cable outlet	Bestell-Nr. Ordering-No.
3+PE	8-10 mm	99 0689 58 04

Technische Daten / Specifications

Polzahl	3+PE	Number of contacts
Steckverbinder Verriegelung	schrauben/screw	Connector locking system
Anschlussart	schraubklemm/screw clamp	Termination
Anschlussquerschnitt	max. 1,5 mm ² (max. AWG 16)	Wire gauge
Kabeldurchlass	8-10 mm	Cable outlet
Schutzart	IP67	Degree of protection
Mechanische Lebensdauer	> 100 Steckzyklen/> 100 mating cycles	Mechanical operation
Obere Grenztemperatur	+ 85 °C	Upper temperature
Untere Grenztemperatur	- 40 °C	Lower temperature
Bemessungsspannung	630 V	Rated voltage
Bemessungs-Stoßspannung	6000 V	Rated impulse voltage
Verschmutzungsgrad	3	Pollution degree
Überspannungskategorie	III	Overvoltage categorie
Isolierstoffgruppe	III	Material group
Bemessungsstrom (40°C)	12 A	Rated current (40 °C)
Durchgangswiderstand	≤ 3 mΩ	Contact resistance
Material Kontakt	CuZn (Messing/brass)	Material of contact
Kontaktoberfläche	Au (Gold/gold)	Contact plating
Material Kontaktkörper	PA	Material of contact body
Material Gehäuse	PA	Material of housing

Kabeldose mit S-Kodierung, Power
Female cable connector with S-coding, Power

Abbildung / Figure



Winkeldose mit S-Kodierung, Power
Female angled connector with S-coding, Power



Maßzeichnung / Drawing

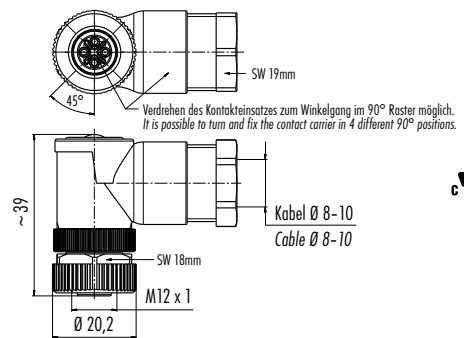
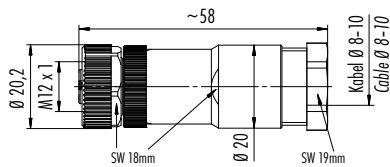

Bestell-Daten / Order Data

Polzahl Contacts	Kabeldurchlass Cable outlet	Bestell-Nr. Ordering-No.
3+PE	8-10 mm	99 0690 19 04

Polzahl Contacts	Kabeldurchlass Cable outlet	Bestell-Nr. Ordering-No.
3+PE	8-10 mm	99 0690 58 04

Technische Daten / Specifications

Polzahl	3+PE	Number of contacts
Steckverbinder Verriegelung	schrauben/screw	Connector locking system
Anschlussart	schraubklemm/screw clamp	Termination
Anschlussquerschnitt	max. 1,5 mm ² (max. AWG 16)	Wire gauge
Kabeldurchlass	8-10 mm	Cable outlet
Schutzart	IP67	Degree of protection
Mechanische Lebensdauer	> 100 Steckzyklen/> 100 mating cycles	Mechanical operation
Obere Grenztemperatur	+ 85 °C	Upper temperature
Untere Grenztemperatur	- 40 °C	Lower temperature
Bemessungsspannung	630 V	Rated voltage
Bemessungs-Stoßspannung	6000 V	Rated impulse voltage
Verschmutzungsgrad	3	Pollution degree
Überspannungskategorie	III	Overvoltage categorie
Isolierstoffgruppe	III	Material group
Bemessungsstrom (40°C)	12 A	Rated current (40 °C)
Durchgangswiderstand	≤ 3 mΩ	Contact resistance
Material Kontakt	CuZn (Messing/brass)	Material of contact
Kontaktoberfläche	Au (Gold/gold)	Contact plating
Material Kontaktkörper	PA	Material of contact body
Material Gehäuse	PA	Material of housing

Montageanleitung
Assembly instruction

Abisoliermaße Kabelsteckverbinder, Schraubklemmanschluss, nicht schirmbar
Strip measures cable connectors, screw clamp connection, not shieldable

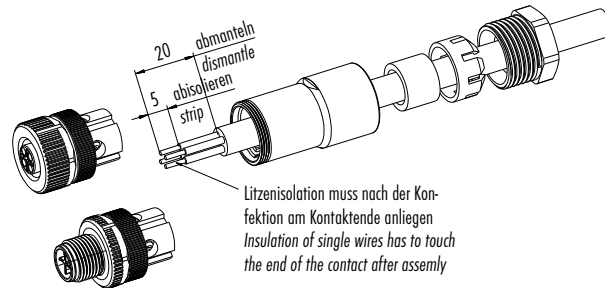

Abisoliermaße Winkelsteckverbinder, Schraubklemmanschluss, nicht schirmbar
Strip measures angled connectors, screw clamp connection, not shieldable

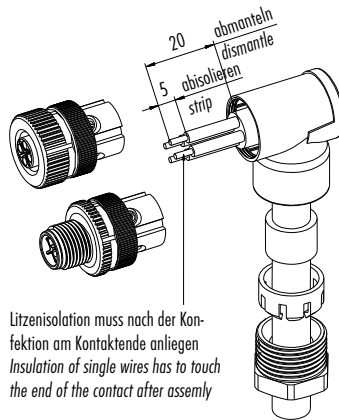

Kennlinie
Rating

Strombelastbarkeitskurve
nach DIN EN 60512 für
POWER-Kabelsteckverbinder

Derating curve
according to DIN EN 60512 for
POWER cable connectors

■ S-Kodierung 4-polig
S-coding 4 pole version

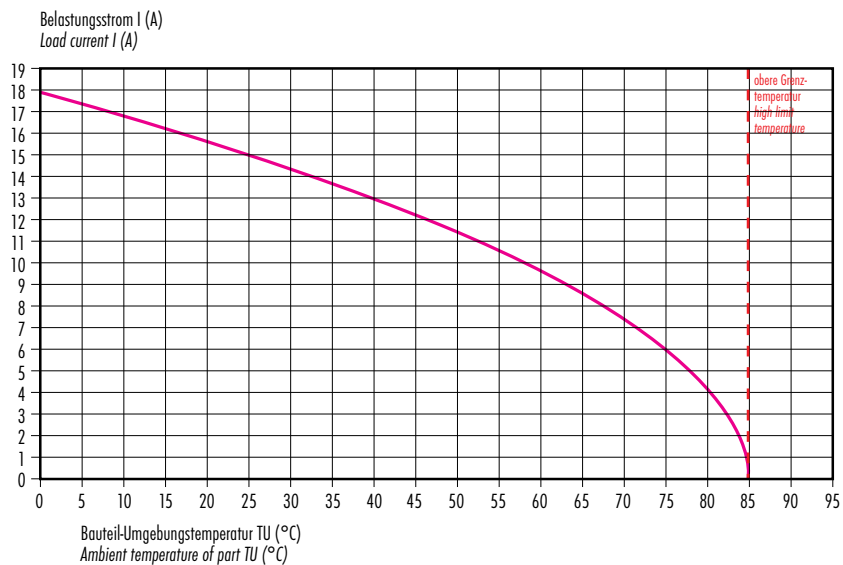



Flanschstecker mit S-Kodierung, Power, Schraubklemmanschluss
Male panel mount connector with S-coding, Power, screw clamp connection

Flanschstecker mit S-Kodierung, Power, mit Litzen
Male panel mount connector with S-coding, Power, with single wires

Abbildung / Figure



Maßzeichnung / Drawing

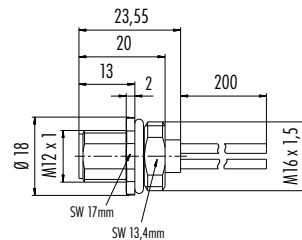
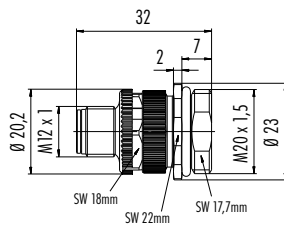

Bestell-Daten / Order Data

Polzahl Contacts	Befestigungsgewinde Fixing thread	Bestell-Nr. Ordering-No.
3+PE	M20 x 1,5	99 0693 500 04

Polzahl Contacts	Befestigungsgewinde Fixing thread	Bestell-Nr. Ordering-No.
3+PE	M16 x 1,5	09 0691 700 04

Technische Daten / Specifications

Polzahl	3+PE	Number of contacts
Steckverbinder Verriegelung	Schrauben/screw	Connector locking system
Anschlussart	Schraubklemm, Litzen (AWG 16)/screw clamp, single wires (AWG 16)	Termination
Anschlussquerschnitt	max. 1,5 mm ² (max. AWG 16)	Wire gauge
Kabeldurchlass	—	Cable outlet
Schutzart	IP67	Degree of protection
Mechanische Lebensdauer	> 100 Steckzyklen/> 100 mating cycles	Mechanical operation
Obere Grenztemperatur	+ 85 °C	Upper temperature
Untere Grenztemperatur	- 40 °C	Lower temperature
Bemessungsspannung	630 V	Rated voltage
Bemessungs-Stoßspannung	6000 V	Rated impulse voltage
Verschmutzungsgrad	3	Pollution degree
Überspannungskategorie	III	Overvoltage categorie
Isolierstoffgruppe	III	Material group
Bemessungsstrom (40°C)	12 A	Rated current (40 °C)
Durchgangswiderstand	≤ 3 mΩ	Contact resistance
Material Kontakt	CuZn (Messing/brass)	Material of contact
Kontaktoberfläche	Au (Gold/gold)	Contact plating
Material Kontaktkörper	PA	Material of contact body
Material Gehäuse	PA, Zink Druckguss vernickelt/zinc diecasting nickel plated	Material of housing

Flanschstecker mit S-Kodierung, Power, von vorn verschraubbar, mit Litzen
 Male panel mount connector with S-coding, Power, front fastened, with single wires

Abbildung / Figure



Flanschstecker mit S-Kodierung, Power, mit Litzen, M20 x 1,5
 Male panel mount connector with S-coding, Power, with single wires, M20 x 1,5



Maßzeichnung / Drawing

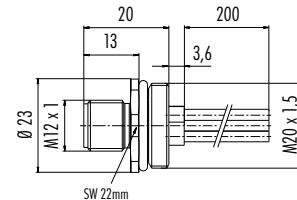
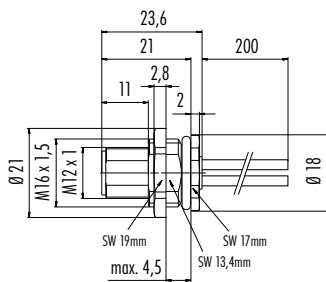

Bestell-Daten / Order Data

Polzahl Contacts	Befestigungsgewinde Fixing thread	Bestell-Nr. Ordering-No.
3+PE	M16 x 1,5	09 0691 121 04

Polzahl Contacts	Befestigungsgewinde Fixing thread	Bestell-Nr. Ordering-No.
3+PE	M20 x 1,5	09 0691 642 04

Technische Daten / Specifications

Polzahl	3+PE	Number of contacts
Steckverbinder Verriegelung	schrauben/screw	Connector locking system
Anschlussart	Litzen (AWG 16)/single wires (AWG 16)	Termination
Anschlussquerschnitt	max. 1,5 mm ² (max. AWG 16)	Wire gauge
Kabeldurchlass	—	Cable outlet
Schutzart	IP67	Degree of protection
Mechanische Lebensdauer	> 100 Steckzyklen/> 100 mating cycles	Mechanical operation
Obere Grenztemperatur	+ 85 °C	Upper temperature
Untere Grenztemperatur	- 40 °C	Lower temperature
Bemessungsspannung	630 V	Rated voltage
Bemessungs-Stoßspannung	6000 V	Rated impulse voltage
Verschmutzungsgrad	3	Pollution degree
Überspannungskategorie	III	Overvoltage categorie
Isolierstoffgruppe	III	Material group
Bemessungsstrom (40°C)	12 A	Rated current (40 °C)
Durchgangswiderstand	≤ 3 mΩ	Contact resistance
Material Kontakt	CuZn (Messing/brass)	Material of contact
Kontaktoberfläche	Au (Gold/gold)	Contact plating
Material Kontaktkörper	PA	Material of contact body
Material Gehäuse	Zink Druckguss vernickelt/zinc diecasting nickel plated, CuZn (Messing vernickelt/brass nickel plated)	Material of housing

Flanschdose mit S-Kodierung, Power, Schraubklemmanschluss
 Female panel mount connector with S-coding, Power, screw clamp connection

Abbildung / Figure



Flanschdose mit S-Kodierung, Power, mit Litzen
 Female panel mount connector with S-coding, Power, with single wires



Maßzeichnung / Drawing

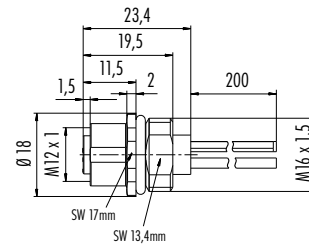
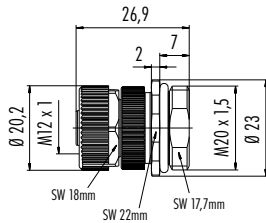

Bestell-Daten / Order Data

Polzahl Contacts	Befestigungsgewinde Fixing thread	Bestell-Nr. Ordering-No.
3+PE	M20 x 1,5	99 0694 500 04

Polzahl Contacts	Befestigungsgewinde Fixing thread	Bestell-Nr. Ordering-No.
3+PE	M16 x 1,5	09 0692 700 04

Technische Daten / Specifications

Polzahl	3+PE	Number of contacts
Steckverbinder Verriegelung	Schrauben/screw	Connector locking system
Anschlussart	Schraubklemm, Litzen (AWG 16)/screw clamp, single wires (AWG 16)	Termination
Anschlussquerschnitt	max. 1,5 mm ² (max. AWG 16)	Wire gauge
Kabeldurchlass	—	Cable outlet
Schutzart	IP67	Degree of protection
Mechanische Lebensdauer	> 100 Steckzyklen/> 100 mating cycles	Mechanical operation
Obere Grenztemperatur	+ 85 °C	Upper temperature
Untere Grenztemperatur	- 40 °C	Lower temperature
Bemessungsspannung	630 V	Rated voltage
Bemessungs-Stoßspannung	6000 V	Rated impulse voltage
Verschmutzungsgrad	3	Pollution degree
Überspannungskategorie	III	Overvoltage categorie
Isolierstoffgruppe	III	Material group
Bemessungsstrom (40°C)	12 A	Rated current (40 °C)
Durchgangswiderstand	≤ 3 mΩ	Contact resistance
Material Kontakt	CuZn (Messing/brass), CuSn (Bronze/bronze)	Material of contact
Kontaktoberfläche	Au (Gold/gold)	Contact plating
Material Kontaktkörper	PA	Material of contact body
Material Gehäuse	PA, Zink Druckguss vernickelt/zinc diecasting nickel plated	Material of housing

Flanschdose mit S-Kodierung, Power, von vorn verschraubbar, mit Litzen
 Female panel mount connector with S-coding, Power, front fastened, with single wires

Abbildung / Figure



Flanschdose mit S-Kodierung, Power, mit Litzen, M20 x 1,5
 Female panel mount connector with S-coding, Power, with single wires, M20 x 1,5



Maßzeichnung / Drawing

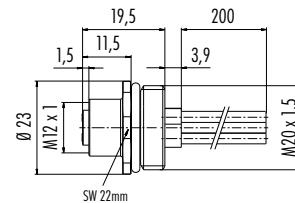
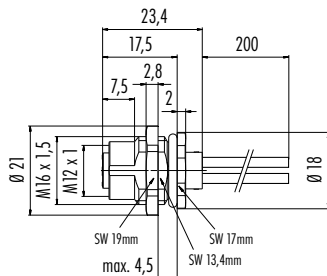

Bestell-Daten / Order Data

Polzahl Contacts	Befestigungsgewinde Fixing thread	Bestell-Nr. Ordering-No.
3+PE	M16 x 1,5	09 0692 121 04

Polzahl Contacts	Befestigungsgewinde Fixing thread	Bestell-Nr. Ordering-No.
3+PE	M20 x 1,5	09 0692 642 04

Technische Daten / Specifications

Polzahl	3+PE	Number of contacts
Steckverbinder Verriegelung	Schrauben/screw	Connector locking system
Anschlussart	Litzen (AWG 16)/single wires (AWG 16)	Termination
Anschlussquerschnitt	max. 1,5 mm ² (max. AWG 16)	Wire gauge
Kabeldurchlass	—	Cable outlet
Schutzart	IP67	Degree of protection
Mechanische Lebensdauer	> 100 Steckzyklen/> 100 mating cycles	Mechanical operation
Obere Grenztemperatur	+ 85 °C	Upper temperature
Untere Grenztemperatur	- 40 °C	Lower temperature
Bemessungsspannung	630 V	Rated voltage
Bemessungs-Stoßspannung	6000 V	Rated impulse voltage
Verschmutzungsgrad	3	Pollution degree
Überspannungskategorie	III	Overvoltage categorie
Isolierstoffgruppe	III	Material group
Bemessungsstrom (40°C)	12 A	Rated current (40 °C)
Durchgangswiderstand	≤ 3 mΩ	Contact resistance
Material Kontakt	CuSn (Bronze/bronze)	Material of contact
Kontaktoberfläche	Au (Gold/gold)	Contact plating
Material Kontaktkörper	PA	Material of contact body
Material Gehäuse	Zink Druckguss vernickelt/zinc diecasting nickel plated, CuZn (Messing vernickelt/brass nickel plated)	Material of housing

Montageanleitung
Assembly instruction

Abisoliermaße Fanschsteckverbinder, Schraubklemmanschluss, nicht schirmbar
Strip measures panel mount connectors, screw clamp connection, not shieldable

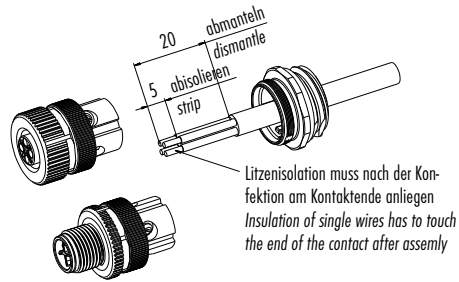

Polbilder
Contact arrangements

Stifteinsatz (Steckseite)
Male insert (mating side)

Buchseinsatz (Steckseite)
Female insert (mating side)

3+PE pol
3+PE contacts

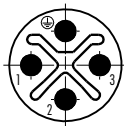

	X	Y
1	-2,55	0,00
2	0,00	-2,55
3	2,55	0,00
PE	0,00	2,55

- 1 schwarz/black
- 2 schwarz/black
- 3 schwarz/black
- PE gelb/grün/yellow/green

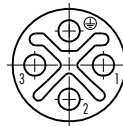

	X	Y
1	2,55	0,00
2	0,00	-2,55
3	-2,55	0,00
PE	0,00	2,55

- 1 schwarz/black
- 2 schwarz/black
- 3 schwarz/black
- PE gelb/grün/yellow/green

Montageausschnitt
Panel cut out

Flanschsteckverbinder
Panel mount connectors

Mit Fläche als Verdrehschutz
With flats as anti-rotation device

Mit Durchgangsbohrung
With bore hole

Mit Gewinde, einschraubbar
With thread to screw in

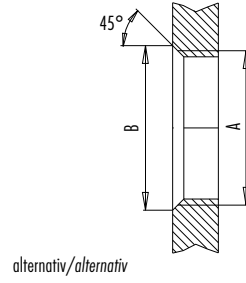
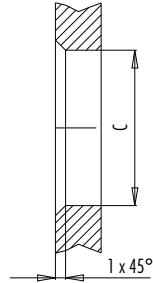
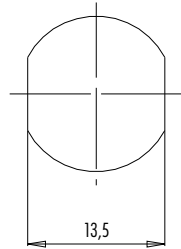

	A	B	C
PG 9	PG 9	16,2	15,3
M16x1,5	M16x1,5	17,0	16,1

Anzugsdrehmoment/Tightening moment

Metallgehäuse/Metal housing 6,25 Nm
Kunststoffgehäuse/Plastic housing 3,75 Nm

Flanschsteckverbinder, von vorn verschraubbar
Panel mount connectors, front fastened

Mit Fläche als Verdrehschutz
With flats as anti-rotation device

Mit Durchgangsbohrung
With bore hole

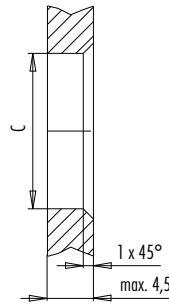
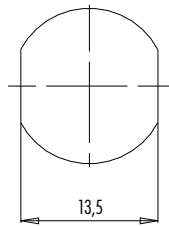

	C
PG 9	15,3
M16x1,5	16,1

Anzugsdrehmoment/Tightening moment

Metallgehäuse/Metal housing 6,25 Nm
Kunststoffgehäuse/Plastic housing 3,75 Nm

Flanschsteckverbinder positionierbar
Panel mount connectors positioning possible

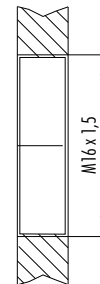

Anzugsdrehmoment/Tightening moment

Metallgehäuse/Metal housing 6,25 Nm
Kunststoffgehäuse/Plastic housing 3,75 Nm

Flanschsteckverbinder Schraubklemmanschluss
Panel mount connectors screw clamp connection

Mit Durchgangsbohrung
With bore hole

Mit Gewinde, einschraubbar
With thread to screw in

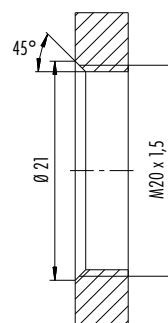
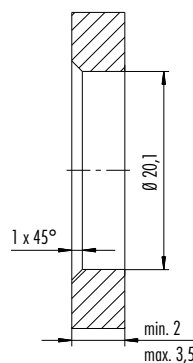

Anzugsdrehmoment/Tightening moment

M20 x 1,5 2 Nm