

Weather Center model 01604



CONTENTS

Unpacking Instructions.....	2	3-in-1 Sensor Installation	10
Package Contents.....	2	Using the Weather Center	11
Product Registration.....	2	Troubleshooting.....	13
Features & Benefits: 3-in-1	3	Care & Maintenance	15
Features & Benefits: Display	4	Calibration	15
Setup	6	Replace Intelli-Time® Battery.....	16
3-in-1 Sensor Setup.....	6	Specifications.....	17
Display Unit Setup.....	7	FCC Information.....	17
Set Time, Date & Units	8	Customer Support	18
Placement Guidelines	9	Warranty.....	18

Questions? Contact Customer Support at (877) 221-1252 or visit www.AcuRite.com.

SAVE THIS MANUAL FOR FUTURE REFERENCE.

ACURITE®

Congratulations on your new AcuRite product. To ensure the best possible product performance, please read this manual in its entirety and retain it for future reference.

Unpacking Instructions

Remove the protective film that is applied to the LCD screen prior to using this product. Locate the tab and peel off to remove.

Package Contents

1. Display unit
2. 3-in-1 sensor
3. Sensor mounting bracket
4. Mounting hardware
5. Power adapter
6. Instruction Manual

IMPORTANT

PRODUCT MUST BE REGISTERED
TO RECEIVE WARRANTY SERVICE

PRODUCT REGISTRATION

Register online
to receive 1 year
warranty protection

www.AcuRite.com



Features & Benefits

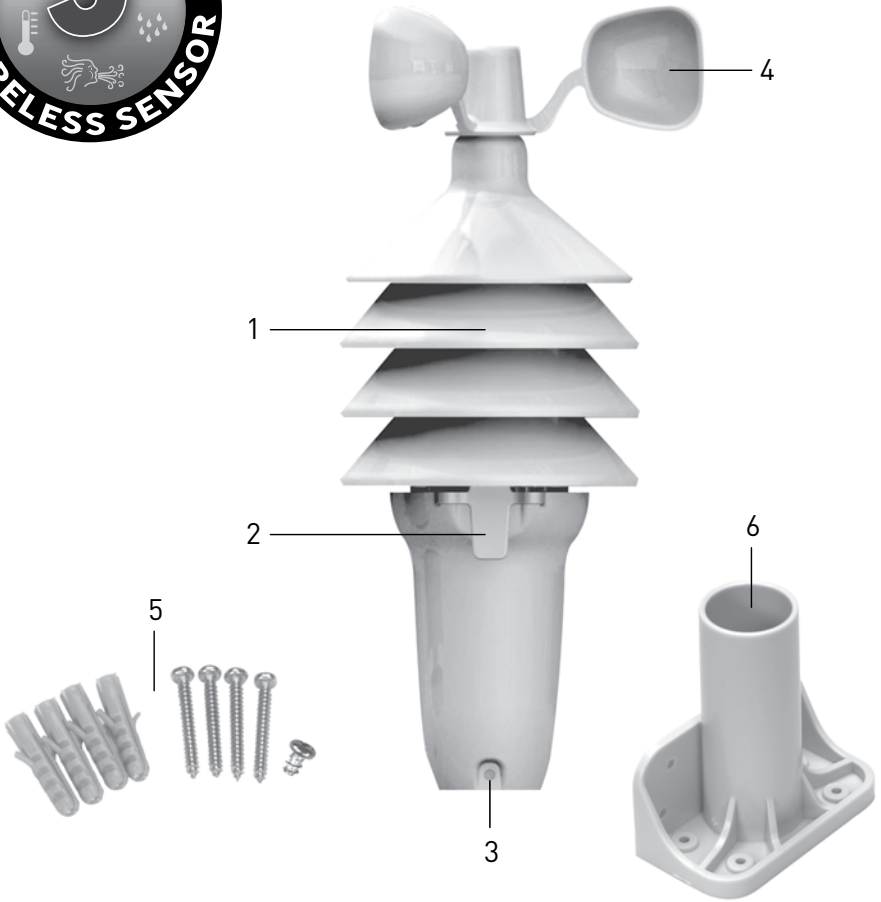

3-in-1 SENSOR

- 1. **Temperature & Humidity Sensors**
(internal)
- 2. **Release Lever for Battery Access**
- 3. **Mounting Point**
- 4. **Wind Speed Anemometer**

5. Mounting Hardware

Includes anchors and screws.

Qty	Diameter	Length
4	#4	1"
1	#6 or #8	1/4" or 3/8"

6. Mounting Bracket

- 7. **A-B-C Switch** (not shown)
ID code that must match display's A-B-C switch to ensure units synchronize.

Features & Benefits

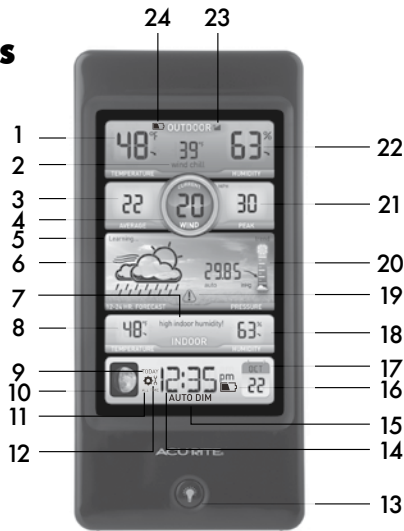

DISPLAY UNIT

- 1. Current Outdoor Temperature**
Arrow icon indicates the direction the temperature is trending.
- 2. Seasonal Information**
Wind chill will show when temperatures are below 40°F (4°C), Dew Point when temperature is 41-79°F (5-26°C), and Heat Index when temperature is over 80°F (27°C).
- 3. Average Wind Speed**
Based on all wind speed readings from the past 2 minutes.
- 4. Current Wind Speed**
- 5. Learning Mode Icon**
Disappears after weather forecast self-calibration is complete.
- 6. 12 to 24 Hour Weather Forecast**
Self-Calibrating Forecasting pulls data from your sensor to generate your personal forecast.
- 7. Humidity Level Indicator**
Indicates a high or low indoor humidity level.
- 8. Current Indoor Temperature**
Arrow icon indicates the direction the temperature is trending.
- 9. Today Icon**
Indicates viewing high/low records since midnight.
- 10. Moon Phase**
- 11. All-Time Icon**
Indicates viewing All-Time records
- 12. SET Icon**
Indicates SET mode.
- 13. Backlight Button**
- 14. Intelli-Time® Clock**
Automatically updates itself for Daylight Saving Time.
- 15. AUTO DIM Mode Indicator** (page 8)
- 16. Display Low Battery Indicator**
- 17. Date**
- 18. Current Indoor Humidity**
Arrow icon indicates the direction the humidity is trending.
- 19. Storm Indicator**
Indicates a rapid drop in pressure and probable storms.
- 20. Barometric Pressure**
Arrow icon indicates the direction the pressure is trending.
- 21. Peak Wind Speed**
Highest speed from past 60 minutes.
- 22. Current Outdoor Humidity**
Arrow icon indicates the direction the humidity is trending.
- 23. Outdoor Sensor Signal Strength**
- 24. Sensor Low Battery Indicator**

Features & Benefits



BACK OF DISPLAY UNIT

- 1. ▲ Button**
for setup preferences.
- 2. ⚙️ Button**
for setup preferences.
- 3. ▼ Button**
for setup preferences.
- 4. ⏪ Button**
Press to access all-time high and low records.

- 5. Battery Compartment**
- 6. Plug-in for Power Adapter**
- 7. A-B-C Switch**
ID code that must match sensor's A-B-C switch to ensure units synchronize.
- 8. Reset Button**
Full reset to factory defaults.
- 9. Power Adapter**
- 10. Battery Compartment Cover**
(not shown)

3-IN-1 Sensor Setup

1 Set the A-B-C Switch

The A-B-C switch is located inside the battery compartment. It can be set to A, B or C. However, you must select the same letter choices for both the sensor and the display unit in order for the units to synchronize.

2 Install or Replace Batteries

AcuRite recommends high quality alkaline or lithium batteries for the best product performance. Heavy duty or rechargeable batteries are not recommended.

The 3-in-1 sensor requires lithium batteries in low temperature conditions. Cold temperatures can cause alkaline batteries to function improperly. Use lithium batteries in the 3-in-1 sensor for temperatures below -4°F / -20°C.

1. Press the release lever and pull off the lower housing of the sensor.
2. Remove the battery compartment cover. Take note of the A-B-C switch setting inside the battery compartment.
3. Insert 4 x AA batteries into the battery compartment, as shown. Follow the polarity (+/-) diagram in the battery compartment.
4. Replace the battery cover and lower housing of the sensor.

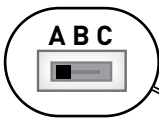

1 A-B-C Switch set to match display unit

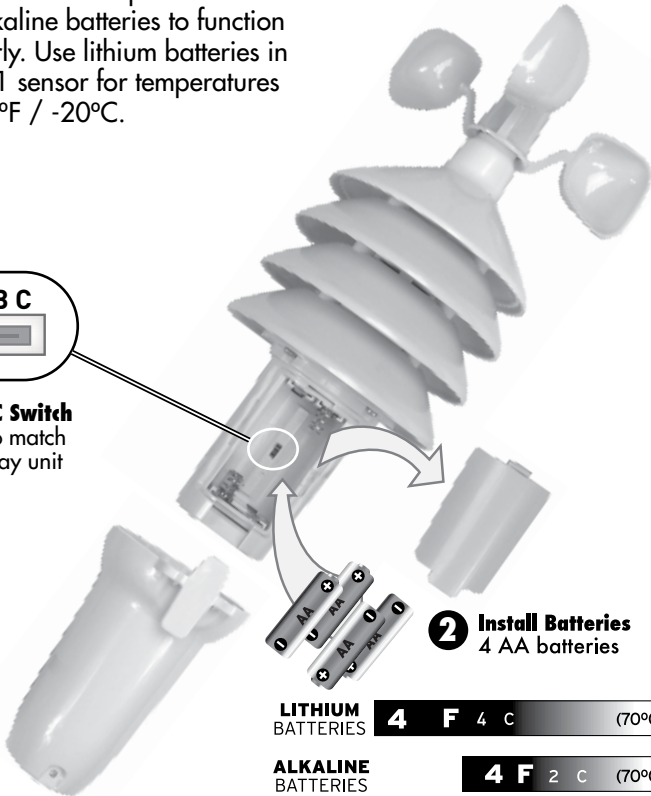

2 Install Batteries
4 AA batteries

LITHIUM BATTERIES **4 F** 4 C (70°C) **158°F**

ALKALINE BATTERIES **4 F** 2 C (70°C) **158°F**

Display Unit Setup

1 Set the A-B-C Switch

Locate the A-B-C switch inside the battery compartment. Set the A-B-C switch to A, B or C. You must select the same letter choices for both the display unit and the sensor in order for the units to synchronize.

2. Insert 3 x AAA alkaline batteries into the battery compartment, as shown. Follow the polarity (+/-) diagram in the battery compartment.

3. Replace the battery cover.

2 Install or Replace Backup Batteries (optional)

1. Remove the battery compartment cover.

3 Plug in Power Adapter

For the best performance, plug in the power adapter as the main power source for this product.



1 A-B-C Switch set to match sensor

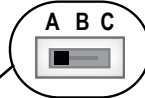

2 Install Backup Batteries (optional)
3 AAA batteries



IMPORTANT: Batteries are a backup power source to preserve records in the event of a power outage. **Power adapter is recommended as the primary power source to enjoy the full functionality of this product.**

3 Plug in Power Adapter





PLEASE DISPOSE OF OLD OR DEFECTIVE BATTERIES IN AN ENVIRONMENTALLY SAFE WAY AND IN ACCORDANCE WITH YOUR LOCAL LAWS AND REGULATIONS.

BATTERY SAFETY: Clean the battery contacts and also those of the device prior to battery installation. Remove batteries from equipment which is not to be used for an extended period of time. Follow the polarity (+/-) diagram in the battery compartment. Promptly remove dead batteries from the device. Dispose of used batteries properly. Only batteries of the same or equivalent type as recommended are to be used. DO NOT incinerate used batteries. DO NOT dispose of batteries in fire, as batteries may explode or leak. DO NOT mix old and new batteries or types of batteries (alkaline/standard). DO NOT use rechargeable batteries. DO NOT recharge non-rechargeable batteries. DO NOT short-circuit the supply terminals.

Set the Time, Date & Units

Press the “” button, located on the front of the display unit, to enter SET MODE. Once in set mode, the preference you are currently setting will blink on the display.

To adjust the currently selected (flashing) item, press and release the “” or “” buttons (press and HOLD to fast adjust).

To save your adjustments, press and release the “” button again to adjust the next preference. The preference set order is as follows:

TIME ZONE

DST (Daylight Savings Time ON or OFF)*

CLOCK HOUR

CLOCK MINUTE

CALENDAR MONTH

CALENDAR DATE

CALENDAR YEAR

TEMPERATURE UNITS (°F or °C)

PRESSURE UNITS (inHg or hPa)

WIND UNITS (MPH or KPH)

You will automatically exit SET MODE if no buttons are pressed for 10 seconds. Enter setup mode at any time by pressing the “” button.

* If you live in an area that observes Daylight Savings Time, DST should be set to ON, even if it is not currently Daylight Savings Time.

Display Backlight Settings

This weather station's color display features three different lighting settings: High (100%) brightness, Medium (60%) brightness and Low (30%) brightness

Using battery power alone, the backlight is available momentarily for 10 seconds by pressing the “” button.

When display is powered with the power adapter, backlight remains on at 100% brightness. Press “” button once to dim to 60% brightness; press again to dim to 30%, press a 3rd time to enter “AUTO DIM” mode. AUTO DIM appears below time.

AUTO DIM MODE: Automatically adjusts display brightness based on time of day & year.	
MARCH 11- NOVEMBER 4	6:00 a.m. - 9:00 p.m. = 100% brightness
	9:01 p.m. - 5:59 a.m.= 30% brightness
NOVEMBER 5 - MARCH 10	7:30 a.m. - 7:00 p.m.= 100% brightness
	7:01 p.m. - 7:29 a.m. = 30% brightness

Placement for Maximum Accuracy

AcuRite sensors are sensitive to surrounding environmental conditions. Proper placement of both the display unit and the sensor are critical to the accuracy and performance of this product.



Display Unit Placement

Place the display unit in a dry area free of dirt and dust. To ensure accurate temperature measurement, place out of direct sunlight and away from heat sources or vents. Display unit stands upright for tabletop use.



3-in-1 Sensor Placement

The 3-in-1 sensor is designed to remain outdoors all year long. Choose an open location with no obstructions above or around the sensor for the most accurate measurements.

Important Placement Guidelines

Display unit and sensor must be within 330 feet (100 m) of each other.

MAXIMIZE WIRELESS RANGE

Place units away from large metallic items, thick walls, metal surfaces, or other objects that may limit wireless communication.

PREVENT WIRELESS INTERFERENCE

Place both units at least 3 feet (.9 m) away from electronic devices (TV, computer, microwave, radio, etc.).

LOCATE AWAY FROM HEAT SOURCES

Position sensor away from heaters, air conditioners, chimneys, exhaust vents, asphalt and concrete (surfaces that radiate heat).

LOCATE AWAY FROM HUMIDITY SOURCES

Avoid installing the sensor near pools, spas, or other bodies of water. Water sources may impact humidity accuracy.

LOCATE AWAY FROM SPRINKLER HEADS

DO NOT install the sensor where it will be sprayed by a sprinkler system. This may force water inside the sensor.

LOCATE AWAY FROM WIND OBSTRUCTIONS

DO NOT mount the sensor with obstructions around it. Consider a location that is a wide open area, with few structures around to ensure accurate wind speed measurement.

Visit us online to view installation photos and video, or learn more about AcuRite technology:

www.AcuRite.com/3in1



View Video

3-in-1 Sensor Installation Guidelines

INSTALLATION HEIGHT Mount the sensor at a minimum height of 5 feet (1.5 meters) off the ground, in an open area. Higher is better for wind measurements - the National Weather Service recommends 33 feet high!

MOUNTING OPTIONS The included mounting bracket is designed to screw directly onto wooden posts or surfaces that are 2"x4" or larger. The sensor can also be mounted directly to 3/4" steel or PVC pipe (available at hardware stores and home centers).

LEVEL INSTALLATION Use a bubble level (not included) to ensure level installation for accurate wind measurement.

Top or Side Mount

1. Insert the mounting base into the hole on the bottom of the sensor.
2. Use one of the screws included in the hardware bag to fasten the lower sensor housing to the mounting base.
3. Fasten mounting base to a post or railing using 2 screws.

Pipe Mount

1. Insert pipe or similar item all the way into the hole on the bottom of the sensor. Note: Mounting base is not used.
2. Use one of the screws included in the hardware bag to fasten the lower sensor housing securely to the pipe.

The 3-in-1 sensor is now ready to use.

Basic Setup is Complete

The 3-in-1 sensor will now synchronize with the display unit. It may take a few minutes for synchronization to complete. If both or one of the units appear to be functioning improperly, please refer to the troubleshooting section.

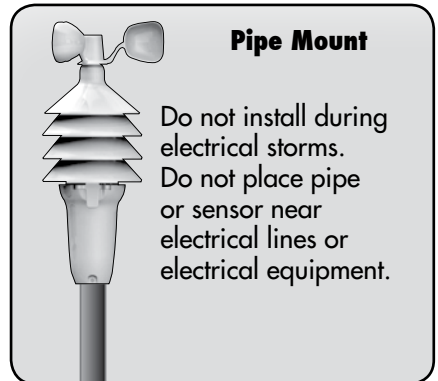
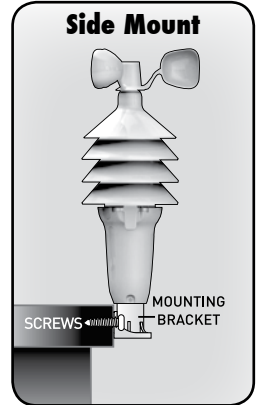
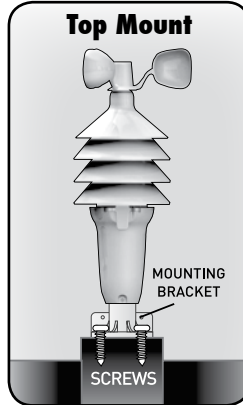

Using The Weather Center

Learning Mode

Self-Calibrating Forecasting use a unique algorithm to analyze changes in pressure over a time period (called Learning Mode) to determine your altitude. After 14 days, the Learning Mode icon disappears from the display screen. At this point, the self-calibrated pressure is tuned in to your location and the unit is ready for superior weather prediction.

Weather Forecast

AcuRite's patented Self-Calibrating Forecasting provides your personal forecast of weather conditions for the next 12 to 24 hours by collecting data from the sensor in your backyard. It generates a forecast with pinpoint accuracy - personalized for your exact location.

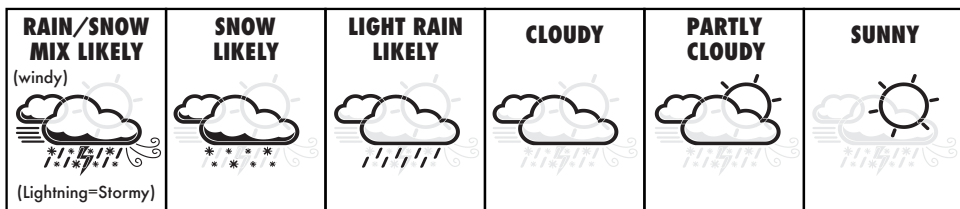

View the complete list of icons at www.AcuRite.com/acurite-icons

Barometric Pressure

Subtle variations in barometric pressure greatly impact the weather. This weather center displays the current pressure with an arrow icon to indicate the direction the pressure is trending (FALLING, STEADY, or RISING).

Moon Phase

Track the phases of the moon, conveyed through simple lunar phase icons:

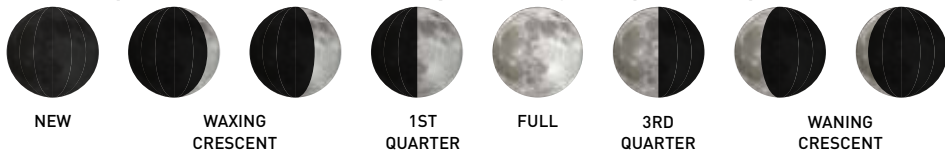

Wind Speed

The Wind Speed area of the display features the CURRENT speed, as well as the AVERAGE and PEAK wind speeds. AVERAGE wind speeds are based on all wind speed readings from the last 2 minutes. PEAK wind speed is the highest speed recorded from the past 60 minutes.

High & Low Records

Today's high and low records are displayed for indoor and outdoor temperature, humidity and wind speed. Today's records automatically clear at 12:00am midnight every day.

To manually clear all of today's LOW recorded values, press and hold the "▼" button for 2 seconds. Dashes display to confirm you have cleared the LOW records.

To manually clear all of today's HIGH recorded values, press and hold the "▲" button for 2 seconds. Dashes display to confirm you have cleared the HIGH records.

Press the "◀◀" button to cycle through the all-time high and low recorded values (one record is shown at a time) for outdoor and indoor temperature and humidity. Located near the clock, a date and time stamp are shown for when each value was recorded. You will automatically exit all-time records if no buttons are pressed for 5 seconds.

To manually clear an all-time LOW record, press and hold the "▼" button for 2 seconds while viewing the record you wish to clear. Dashes display to confirm you have cleared the record.

To manually clear an all-time HIGH record, press and hold the "▲" button for 2 seconds while viewing the record you wish to clear. Dashes display to confirm you have cleared the record.

Troubleshooting

Problem	Possible Solution
<p>No outdoor sensor reception</p>  no bars	<ul style="list-style-type: none"> • Relocate the display unit and/or the 3-in-1 sensor. The units must be within 330 ft (100 m) of each other. • Make sure both units are placed at least 3 feet (.9 m) away from electronics that may interfere with the wireless communication (such as TVs, microwaves, computers, etc). • Use standard alkaline batteries (or lithium batteries in sensor when temperature is below -4°F/-20°C). Do not use heavy duty or rechargeable batteries. NOTE: It may take up to 20 minutes for display unit and sensor to synchronize after batteries are replaced. • Synchronize the units: <ol style="list-style-type: none"> 1. Bring both the sensor and display unit indoors and remove at least one battery from each. 2. Make sure the A-B-C switch on both units match. 3. Reinstall the battery in the outdoor sensor. 4. Reinstall battery into the display unit. 5. Let the units sit within a couple feet of each other for about 20 minutes to gain a strong connection.
<p>Outdoor temperature is flashing or showing dashes</p>	<p>Flashing of the outdoor temperature may be an indication of wireless interference:</p> <ul style="list-style-type: none"> • Make sure the A-B-C switch in the battery compartments of both the display unit and sensor are switched to the same letter. You may choose A, B or C; but both units must match to sync up. Sometimes changing to a different channel can help.
<p>Inaccurate forecast</p>	<ul style="list-style-type: none"> • Weather Forecast icon predicts conditions for the next 12 to 24 hours, not current conditions. • Has Learning Mode icon disappeared from the display unit? Learning Mode must complete before forecast and pressure will be accurate. • Allow unit to run continuously for 33 days. Battery removal or resetting the display unit will restart Learning Mode. After 14 days, forecast should be fairly accurate, however Learning Mode calibrates for a total of 33 days.

Troubleshooting

Problem	Possible Solution
<p>Inaccurate temperature or humidity</p>	<ul style="list-style-type: none"> • Make sure both the display unit and 3-in-1 sensor are placed away from any heat sources or vents (see page 9). • Make sure both units are positioned away from moisture sources (see page 9). • Make sure 3-in-1 sensor is mounted at least 5 ft off of the ground. • Calibrate indoor and outdoor temperature and humidity (see page 15).
<p>Inaccurate wind readings</p>	<ul style="list-style-type: none"> • What is wind reading being compared to? Pro weather stations are typically mounted at 30 ft high or more. Make sure to compare data using a sensor positioned at the same mounting height. • Check location of the sensor. Ensure it's mounted a minimum of 5 ft in the air with no obstructions around it (within several feet). • Ensure wind cups are spinning freely. If they hesitate or stop try lubricating with graphite powder or spray lubricant.
<p>Display screen not working</p>	<ul style="list-style-type: none"> • Check that the batteries are installed correctly. Batteries may need to be replaced. • Reset the display by pressing the RESET button, located on the back of the display unit in the battery compartment. Date and time will need to be entered after a reset.
<p>Inaccurate barometric pressure</p>	<p>It may take up to 14 days for the pressure to calibrate to your location.</p>
<p>The unit lost power or batteries were changed and the time is not correct</p>	<p>The Intelli-Time battery needs to be replaced (see page 16). Once the new battery is installed, time and date will need to be set manually.</p>

If your AcuRite product does not operate properly after trying the troubleshooting steps, visit www.AcuRite.com or call (877) 221-1252 for assistance.

Care & Maintenance

Display Unit Care

Clean with a soft, damp cloth. Do not use caustic cleaners or abrasives. Keep away from dust, dirt and moisture. Clean ventilation ports regularly with a gentle puff of air.

3-in-1 Sensor Care

Clean the Sensor

Clean with a soft, damp cloth. Do not use caustic cleaners or abrasives.

Insect Prevention

Insects may cause obstructions and interrupt data by nesting in or on the 3-in-1 sensor. To limit this problem, spray sensor housing with a household insect repellent. Note: Insect repellent should not be sprayed on the internal components or into the sensor. Consult insect repellent instructions prior to use.

Snow & Freezing Weather

The 3-in-1 sensor will not be damaged by freezing conditions.

Clean the Wind Anemometer

Remove foreign matter from the outside of the sensor for free movement of the wind anemometer. If needed, use a small amount of spray lubricant, clear silicone or graphite powder on the anemometer for improved movement. Note: Spray lubricant, clear silicone or graphite powder should not be sprayed on the internal components or into the sensor.

Calibration

The indoor / outdoor temperature and humidity readings, and barometric pressure can be calibrated on the display unit to improve accuracy. Calibration can improve accuracy when sensor placement or environmental factors impact the data accuracy.

1. To access calibration mode, press AND HOLD the “▲”, “⚙️”, and “▼” buttons simultaneously for at least 5 seconds.
2. To adjust the currently selected (flashing) item, press and release the “▲” or “▼” buttons to calibrate the data value higher or lower from the actual reading.
3. To save your adjustments, press and release the “⚙️” button to adjust the next preference. The “☑️” icon will remain illuminated next to calibrated values.

The preference set order is as follows:

OUTDOOR TEMPERATURE

OUTDOOR HUMIDITY

INDOOR TEMPERATURE

INDOOR HUMIDITY

BAROMETRIC PRESSURE (must be set to MANUAL mode to calibrate)*

*To change from AUTO to MANUAL pressure mode and vice versa, press AND HOLD the “⚙️” button for at least 10 seconds. The display indicates the current pressure mode selected, “AUTO” or “MANUAL”.

After 20 seconds of inactivity, the display will save the adjustments and exit calibration mode. Note: Calibrations will be erased if the display is reset or if batteries are removed and the power adapter is unplugged.

Replace Intelli-Time® Clock Battery

Intelli-Time technology is powered by a pre-installed coin-cell battery that stores the time and date settings. The battery has a shelf life of several years. To replace the Intelli-Time battery:

1. Locate the coin cell battery compartment door on the back of the display unit. Unscrew and remove the compartment cover.
2. Insert 1 x CR2032 coin cell battery into the battery compartment, as shown. Install battery with “+” positive terminal facing OUT.
3. Screw in the battery cover.

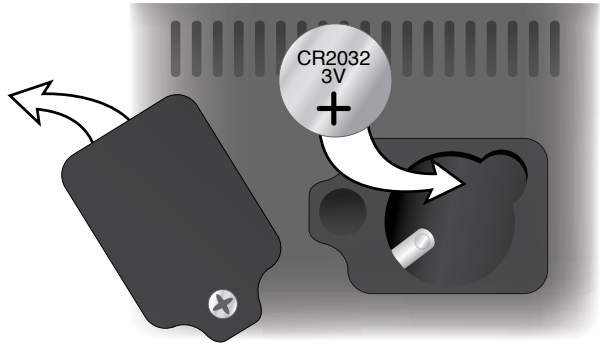

WARNING: THIS PRODUCT CONTAINS A BUTTON-CELL BATTERY. IF SWALLOWED, IT COULD CAUSE SEVERE INJURY OR DEATH IN JUST 2 HOURS. SEEK MEDICAL ATTENTION IMMEDIATELY IF INGESTED.



Specifications

TEMPERATURE RANGE	Outdoor: -40°F to 158°F; -40°C to 70°C
	Indoor: 32°F to 122°F; 0°C to 50°C
HUMIDITY RANGE	Outdoor: 1% to 99%
	Indoor: 1% to 99%
WIND SPEED	0 to 99 mph; 0 to 159 kph
WIRELESS RANGE	330 ft / 100 m depending on home construction materials
OPERATING FREQUENCY	433 mhz
POWER	Display: 5V, 100mA power adapter 3 x AAA alkaline batteries Sensor: 4 x AA alkaline or lithium batteries
DATA REPORTING	Wind Speed: 18 second updates
	Outdoor temperature & humidity: 18 second updates
	Indoor temperature & humidity: 60 second updates

FCC Information

This device complies with part 15 of FCC rules. Operation is subject to the following two conditions:

1- This device may NOT cause harmful interference, and

2- This device must accept any interference received, including interference that may cause undesired operation.

WARNING: Changes or modifications to this unit not expressly approved by the party responsible for compliance could void the user's authority to operate the equipment.

NOTE: This equipment has been tested and found to comply with the limits for a Class B digital device, pursuant to Part 15 of the FCC rules. These limits are designed to provide reasonable protection against harmful interference in a residential installation. This equipment generates, uses and can radiate radio frequency energy and, if not installed and used in accordance with the instructions, may cause harmful interference to radio communications.

However, there is no guarantee that interference will not occur in a particular installation. If this equipment does cause harmful interference to radio or television reception, which can be determined by turning the equipment off and on, the user is encouraged to try to correct the interference by one or more of the following measures:

- Reorient or relocate the receiving antenna.
- Increase the separation between the equipment and the receiver.
- Connect the equipment into an outlet on a circuit different from that to which the receiver is connected.
- Consult the dealer or an experienced radio/TV technician for help.

NOTE: The manufacturer is not responsible for any radio or TV interference caused by unauthorized modifications to this equipment. Such modifications could void the user authority to operate the equipment.

This device complies with Industry Canada licence-exempt RSS standard(s).

Operation is subject to the following two conditions:

(1) This device may not cause interference, and

(2) This device must accept any interference received, including interference that may cause undesired operation of the device.

Customer Support

AcuRite customer support is committed to providing you with best-in-class service. **For assistance**, please have the model number of this product available and contact us in any of the following ways:



(877) 221-1252



info@chaney-inst.com

24/7 support at www.AcuRite.com

- ▶ Installation Videos
- ▶ Register your Product
- ▶ Instruction Manuals
- ▶ Support User Forum
- ▶ Replacement Parts
- ▶ Submit Feedback & Ideas

IMPORTANT

PRODUCT MUST BE REGISTERED
TO RECEIVE WARRANTY SERVICE

PRODUCT REGISTRATION

Register online
to receive 1 year
warranty protection

www.AcuRite.com

FOR NOW

SUPPORT

Support Forum

Archived Products

▶ Register a Product

Limited One Year Warranty

At AcuRite, we proudly uphold our commitment to quality technology. Chaney Instrument Co. warrants that all products it manufactures to be of good material and workmanship, and to be free of defects when properly installed and operated for a period of one year from the date of purchase.

We recommend that you visit us at www.AcuRite.com for the fastest way to register your product. However, product registration does not eliminate the need to retain your original proof of purchase in order to obtain warranty benefits.

Chaney Instrument Co. warrants that all products it manufactures to be of good material and workmanship, and to be free of defects when properly installed and operated for a period of one year from the date of purchase. Remedy for breach of this warranty is limited to repair or replacement of the defective item(s). Any product which, under normal use and service, is proven to breach the warranty contained herein within ONE YEAR from date of sale will, upon examination by Chaney, and at its sole option, be repaired or replaced by Chaney. Transportation costs and charges for returned goods shall be paid for by the purchaser. Chaney hereby disclaims all responsibility for such transportation costs and charges. This warranty will not be breached, and Chaney will give no credit for products

it manufactures which have received normal wear and tear, been damaged (including by acts of nature), tampered, abused, improperly installed, damaged in shipping, or repaired or altered by others than authorized representatives of Chaney.

The above-described warranty is expressly in lieu of all other warranties, express or implied, and all other warranties are hereby expressly disclaimed, including without limitation the implied warranty of merchantability and the implied warranty of fitness for a particular purpose. Chaney expressly disclaims all liability for special, consequential or incidental damages, whether arising in tort or by contract from any breach of this warranty. Some states do not allow the exclusion or limitation of incidental or consequential damages, so the above limitation or exclusion may not apply to you. Chaney further disclaims all liability from personal injury relating to its products to the extent permitted by law. By acceptance of any of Chaney's products, the purchaser assumes all liability for the consequences arising from their use or misuse. No person, firm or corporation is authorized to assume for Chaney any other liability in connection with the sale of its products. Furthermore, no person, firm or corporation is authorized to modify or waive the terms of this paragraph, and the preceding paragraph, unless done in writing and signed by a duly authorized agent of Chaney. This warranty gives you specific legal rights, and you may also have other rights which vary from state to state.

For in-warranty claims:
Chaney Instrument Co. | 965 Wells St. | Lake Geneva, WI 53147

ACURITE®



Weather
Stations



Temperature
& Humidity



Weather
Alert Radio



Kitchen
Thermometers
& Timers



Clocks

It's more than accurate, it's ACURITE®.

AcuRite offers an extensive assortment of precision instruments,
designed to provide you with information you can depend on to
Plan your day with confidence™.

www.AcuRite.com