

**POFER**[®]
screw conveyors

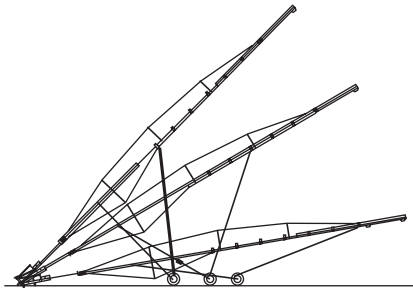

Specialisti delle coclee
The experts in screw conveyors
Die Spezialisten für Schneckenförderer
Les spécialistes des transporteurs à vis
Los especialistas en transportadores helicoidales

SUPERGIGANT



Trasportatori a Coclea trainabili (supergigant)
Towable "supergigant" screw conveyors
Schleppbare "Supergigant" Förderschnecken
Vis "Supergigant" sur chariot
Transportadores de tornillo sinfín remolcables Supergigant

CR 150/200

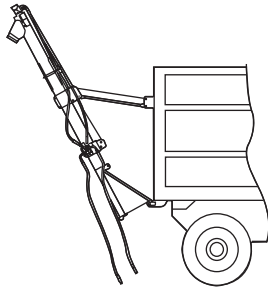

Coclee tubolari a motore idraulico serie CR 150/200
Tubular screw conveyors with hydraulic motor series CR 150/200
Rohrförderschnecken Serie CR mit Hydraulik-Motor Typ CR 150/200
Vis tubulaires avec moteur hydraulique série CR 150/200
Transportadores tubulares de tornillo sinfín con motor hidráulico serie CR 150/200

CR 420

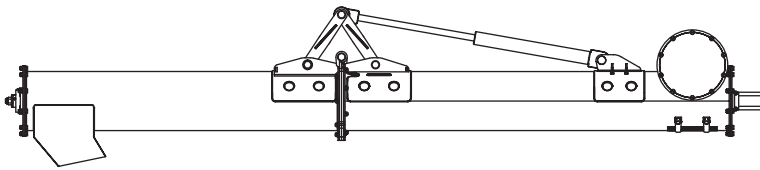

Coclee tubolari a motore idraulico serie CR 420
Tubular screw conveyors with hydraulic motor series CR 420
Rohrförderschnecken Serie CR mit Hydraulik-Motor Typ CR 420
Vis tubulaires avec moteur hydraulique série CR 420
Transportadores tubulares de tornillo sinfín con motor hidráulico serie CR 420

F.P.

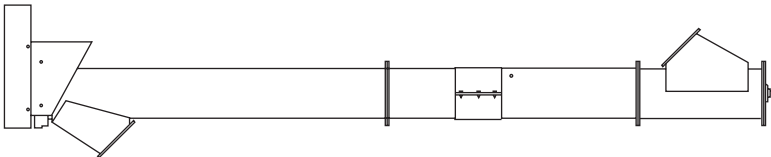

Coclee tubolari serie F. P.
Tubular screw conveyors series F.P.
Rohrschnecken - F.P. Serie
Convoyeurs tubulaires à vis séries F. P.
Transportadores tubulares de tornillo sinfín serie F.P.

FLEX

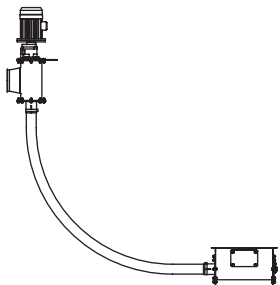

Coclee flessibili
Flexible screw conveyors
Flexible Förderschnecken
Transporteurs à vis flexible
Transportadores de tornillo sinfín flexibles

TROUGH

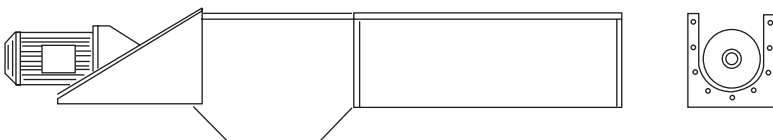

Trasportatori a coclea aperta
Trough screw conveyors
Förderer mit offener Schnecke
Transporteurs à vis en auge
Transportadores de tornillo sinfín abierto

Alimentari
Food
Nahrungsmittel
Alimentaire
Alimentario

Energetico
Energy
Energie
Énergétique
Energía

Ecologico
Ecology
Umweltschutz
Ecologie
Ecología

Chimico
Chemistry
Chemie
Chimique
Químico

Plastico
Plastic
Kunststoff
Plastique
Plástico

Inerti
Inerts
Inertmaterialien
Inertes
Áridos

Agricoltura
Agriculture
Landwirtschaft
Agriculture
Agricultura

Ceramica
Ceramics
Keramik
Céramique
Cerámica

TUBOLAR light

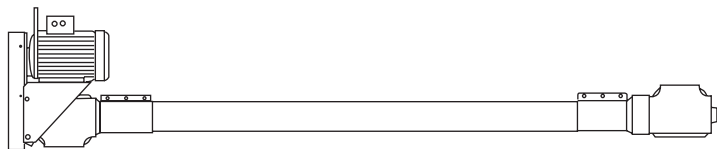

Trasportatori estrattori tubolari a coclea
Extracting tubular screw conveyors
Röhrenförmige Ausziehschneckenförderer
Extracteurs à vis sans fin tubulaires
Extractores tubulares de tornillo sinfín

INDUSTRIAL

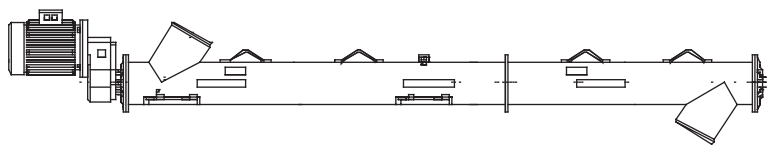

Trasportatori e mescolatori a coclea tipo industriale
Industrial screw conveyors
Schneckenförderer und Mischer Industrietyp
Transporteurs à vis industriels
Transportadores y mezcladores de tornillo sinfín industriales

MULTISPIRA

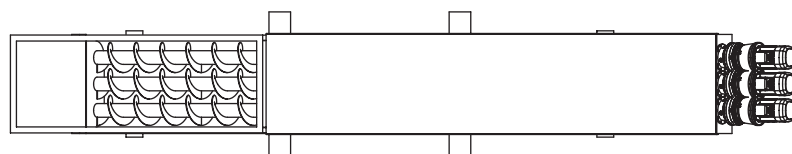

Fondi cocleati
Multi-spiral through screw conveyors
Multi-Spiralen Trogförderschnecken
Vis en auge multivis
Transportadores de tornillo sinfín de canal multiespiral

SLUDGE

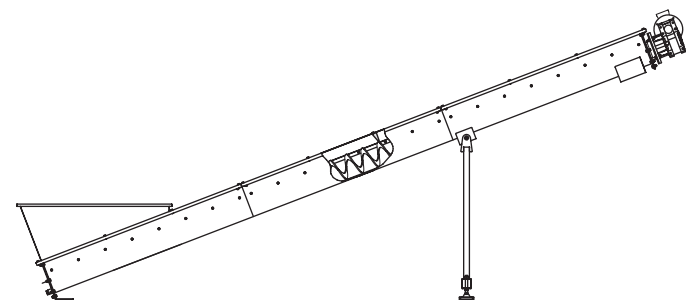

Trasporto fanghi da depurazione
Conveying sludge from wastewater treatment
Le transport des boues de traitement des eaux usées
Transport von Klärschlamm aus Kläranlagen
Transporte de lodos de tratamiento de aguas residuales

MVP

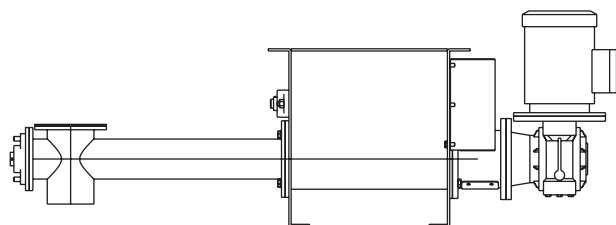

Microdosatori Volumetrici MVP
Volumetric Micro (dosing screw conveyor) MVP
Volumetrische Mikrodosierer MVP
Micros doseurs volumétriques MVP
Microdosificadores volumétricos MVP

C.R.P.

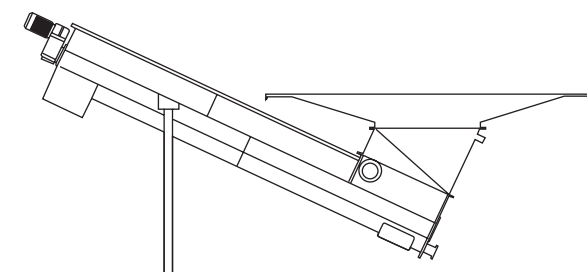

C.R.P. Impianto di riciclaggio calcestruzzo
Concrete recycling plants C.R.P.
C.R.P. Zement-Recycling-Anlage
C.R.P. Implantation pour la réutilisation du ciment de retour des chantiers
C.R.P. Instalación para reciclaje de hormigón

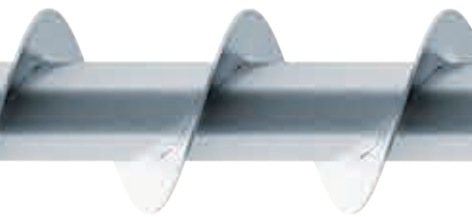

Via Oberdan, 37/39 - 45037 Melara (RO) Italy
tel: +39 0425 89000 fax: +39 0425 89698
www.pofer.it - info@pofer.it

screw conveyors

