

RTP-500
RUBBER-TRACKED PLACER



GOMACO®

The Worldwide Leader in Concrete Paving Technology

RTP-500 Placing Conveyor Provides High-Production Results

High-production results are achieved with the versatility of the long placing conveyor. The conveyor is 35 feet (10.67 m) long and 36 inches (914 mm) wide, with 170 degree hydraulic swing, and 12 feet (3.66 m) of hydraulic elevation adjustment. The placing conveyor allows for fast and accurate material placement from the haul road, over the stringline or other obstacles, and reaches across the grade. The conveyor deflector directs the flow of concrete at the discharge end of the conveyor.



Receiving Hopper Designed For Maximum Throughput

The auger-style receiving hopper is 10.75 feet (3.28 m) wide, and has a working capacity of 4.75 yd³ (3.63 m³). It's built with the strength and durability for handling high-volume throughput for end-dump paving operations. The hopper features a 12 inch (305 mm) hydraulic vertical adjustment to allow for variable gate height on dump trucks. A 14 inch (356 mm) diameter auger with split flighting and speeds up to 88 rpm quickly moves the material to the transfer conveyor. Shaft-mounted eccentric vibrators provide vibration for emptying the hopper after each load and increased flowability. The hopper/truck seal is supported by a hydraulically tensioned cable for consistent sealing on a wide variety of dump truck bodies. The 36 inch (914 mm) wide, 16.6 foot (5.06 m) long transfer conveyor moves material to the rear placing conveyor at speeds up to 608 feet per minute (185 mpm). Both conveyors are activated with a single switch and have individual speed controls.



CS-120101-D29

The hopper features a 12 inch (305 mm) hydraulic vertical adjustment to allow for variable gate height on dump trucks. The hopper/truck seal moves out for additional cleaning.



CS-120103-D11

The RTP-500 has tractive power for pushing trucks and its rubber tracks go where tires do not dare.

The step on the side of the hopper provides a spot for the truck control coordinator to monitor the hopper as concrete is dumped, along with being able to guide the trucks as they back into position for the RTP-500. The hopper remote control allows the truck control coordinator to raise and lower the hopper, turn the vibrators on or off, adjust the variable gate height, operate the hitch lock, and turn the high-pressure water on or off.



CC-081402-D9

High-Volume Placing With High-Speed Mobility

Fast Job-Site Mobility with Rubber Tracks

The GOMACO RTP-500, powered by a John Deere 6068H turbocharged diesel engine, has fast job-site mobility, with a travel speed up to seven miles per hour (11 kph), and an operating speed up to 110 feet per minute (33.5 mpm). The rubber tracks can go where rubber tires don't dare.



Hydraulically Folding Rear Conveyor Minimizes Transport Requirements

The hydraulically folding rear conveyor minimizes the transport requirements on the RTP-500. The overall shipping length is 37.25 feet (11.35 m), width is 11.8 feet (3.6 m) with the hopper attached, 10.3 feet (3.14 m) without the hopper, and a height of 11.7 feet (3.57 m) with the conveyor folded.

Versatility

GOMACO's RTP-500 rubber-tracked placer provides more versatility by being able to place a variety of materials for different applications.



This RTP-500, equipped with heat-resistant belts, is used in the placement of asphalt on this mainline paving project.



The GOMACO RTP-500 places material in a trench to fill in around a large pipeline.

*All dimensions are nominal.

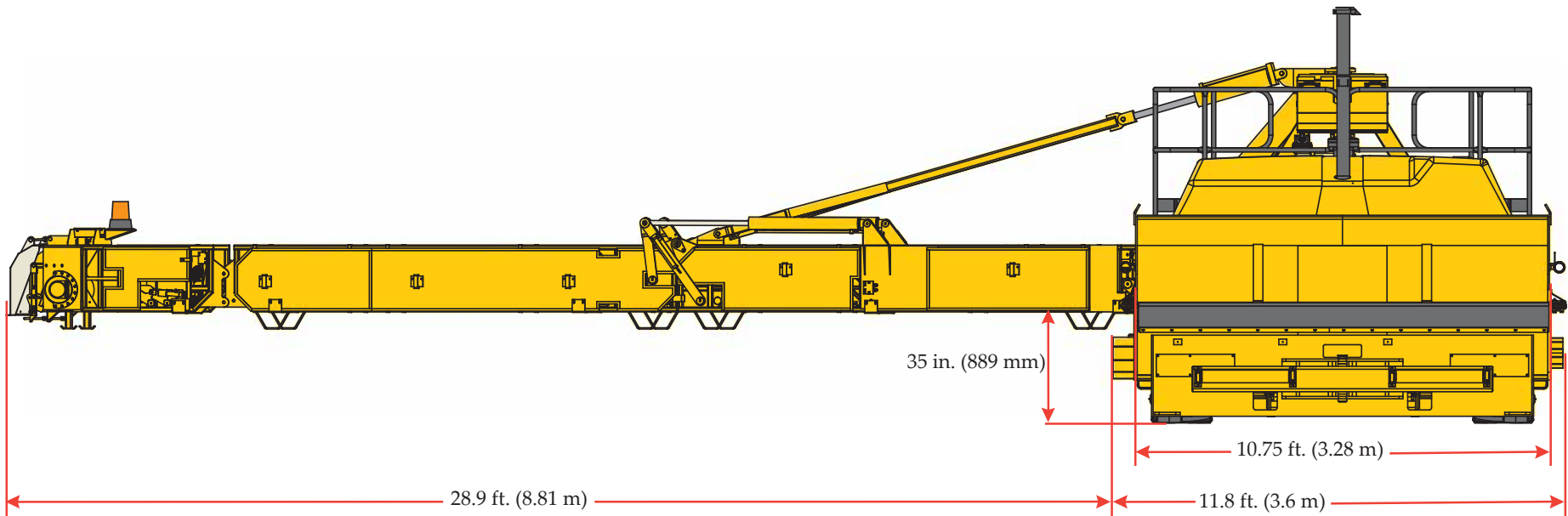
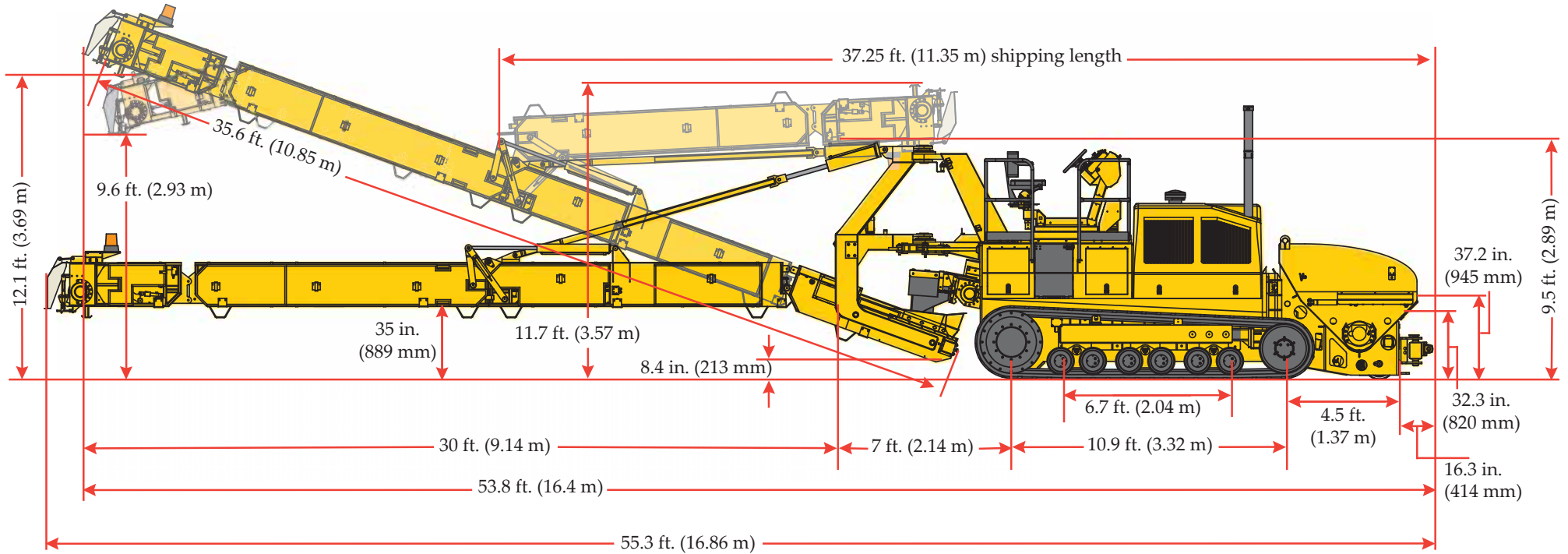

G+® Controls

A flat-panel 6.5 inch (165 mm) anti-glare display screen is provided with sensor-controlled backlight levels for superior visibility in all operating conditions. The screen is rugged and shock resistant in its construction to protect against dust, moisture, and rain. G+ provides a full color display on the control panel to illustrate the various aspects of the placer operation. Newly designed icons and color graphics make it easy to understand and identify the targeted functions. G+ controls feature a detailed fault history with the time stamp, date, and information to track when each fault occurred. GOMACO's G+ control system has been proven around the world.



Console Positioning Versatility

The operator's platform provides a panoramic view of the entire operation. The console and chair roll from left to right on the platform to provide more comfort and visibility for the operator. The versatile console can be set at five different positions. It can be positioned straight forward or turned 90 degrees to the left or right.

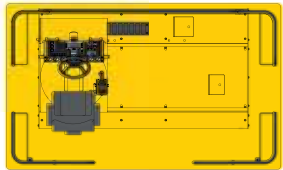

Left side straight ahead position

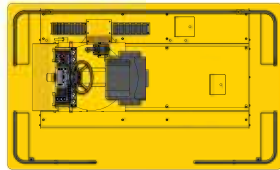

Left center with 90 degree rotation

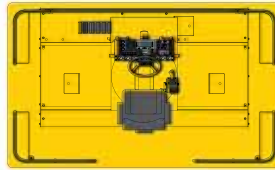

Center straight ahead position

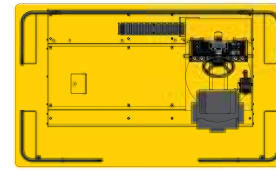

Right side straight ahead position

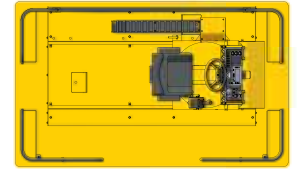

Right center with 90 degree rotation



The RTP-500 with its 19 inch (483 mm) wide and 13.5 feet (4.11 m) long rubber placer tracks can traverse any terrain to get the job done.



Placing accuracy with the discharge conveyor is accomplished with joystick control next to the operator's chair.

GOMACO s RTP-500 Placer Specifications

ENGINE

Type: Turbocharged diesel.
Make: John Deere 6068H.
Number of cylinders: 6.
Displacement: 6.8 L (415 in³).
Power: 250 hp (186.5 kW).

SERVICE CAPACITIES

Fuel reservoir: 85 gal. (322 L).
Hydraulic oil reservoir: 100 gal. (379 L).
Water tank: 130 gal. (492 L).

AUTOMATIC CONTROL SYSTEM

Type: Electronic-over-hydraulic.
G+ control system: Self-diagnostics and smart steer controls for ease of operation. Includes a graphic display controller with multi-language capability.
Operator's console: Provides ultimate operator visibility during the entire operation. The operator's console rolls from left to right on the platform to provide more comfort and visibility for the operator. The console can be set at five different positions. It can be positioned straight forward or turned 90 degrees to the left or right.

RECEIVING HOPPER

Type: Auger-style hopper.
Width: 10.75 ft. (3.28 m).
Working capacity: 4.75 yd³ (3.63 m³).
Truck pusher: Pivoting roller or optional quick hitch.
Hydraulic vertical adjustment: 12 in. (305 mm) hydraulic vertical adjustment to allow for gate height on dump trucks.
Vibration: Shaft-mounted eccentric vibrators provide vibration for emptying the hopper after each load and increased flowability.
Rubber hopper/truck seal: The hopper/truck seal is supported by a hydraulically tensioned cable for consistent sealing on a wide variety of dump truck bodies.

AUGER

Size: 14 in. (356 mm) diameter x 14 in. (356 mm) pitch.
Speed: Up to 88 rpm.
Flighting: Welded or bolt-on.

CONVEYORS (transfer conveyor and hydraulically folding rear conveyor)

Controls: Both conveyors are activated with a single switch and have individual speed controls.
Belt speed: 608 fpm (185 mpm).
Transfer conveyor width: 36 in. (914 mm).
Rear conveyor width: 36 in. (914 mm).
Rear conveyor length: 35 ft. (10.67 m).
Rear conveyor hydraulic elevation: 12 ft. (3.66 m).
Rear conveyor hydraulic swing: 170 degrees.

TRACK SYSTEM

Type: Two GOMACO friction drive rubber tracks.
Track width: 19 in. (483 mm).
Track length: 13.5 ft. (4.11 m).
Automatic tensioning: Hydraulic.
Bogie wheels: 13 in. (330 mm) diameter, 12 per track, steel/rubber, oscillating - 2 in. (51 mm) total vertical travel per wheel.
Idler wheels: 24 in. (610 mm) diameter, two per track, steel/rubber.
Final drive: Comer two-speed planetary with parking brake.
Pump and motors: Danfoss heavy-duty closed-loop.
Tractive effort: 20,000 lbf. (88,964 N).
Travel speed: Up to 7 mph (11 kph).
Work speed: Up to 110 fpm (33.5 mpm).
Ground pressure: 50,000 lb. (22,680 kg) empty: 10.1 psi (70 kPa).
64,000 lb. (29,030 kg) loaded: 13.2 psi (91 kPa).

DIMENSIONS

Shipping width with hopper: 11.8 ft. (3.6 m).
Shipping width without hopper: 10.3 ft. (3.14 m).
Shipping height with conveyor folded: 11.7 ft. (3.57 m).
Height without conveyor folded: 9.5 ft. (2.9 m).
Shipping length with conveyor folded: 37.25 ft. (11.35 m).
Machine weight: 50,000 lb. (22,680 kg).
Operational width: 11.8 ft. (3.6 m).
Operational length and height: Variable length and height depending on conveyor positioning. (Note: See drawings and dimensions on inside pages.)

Safety Features

The conveyor must be centered and folded before G+® controls will allow for travel speed. There is no counter rotation of tracks in the travel speed. The steering sensitivity is programmed to provide balanced steering control at low or high speeds, preventing the operator from oversteering at high speeds. Five emergency stop (E-stop) buttons are located on strategic areas of the machine. G+ features control interlocks to prevent unexpected movements at start-up. The RTP-500 has many other safety features, including a flashing light on the end of the conveyor, a belt swing alarm, back-up alarm, operator horn, and the hopper remote control.

You can always find us at
<http://www.gomaco.com/rtp500>

Cover Photo: CG-061417-D1

Manufactured under one or more of the following U.S. or foreign patents: 5,924,817; 5,941,659; 6,099,204; 6,450,048; CA2,211,331; 7,044,680; 7,284,472; 7,517,171; 7,845,878; 7,850,395; CA2,864,902; CA2,591,177; 8,855,967; 8,682,622; 9,051,696; and patents pending.

GOMACO and G+ are registered trademarks of GOMACO Corporation.

GOMACO Corporation reserves the right to make improvements in design, material, and/or changes in specifications at any time without notice and without incurring any obligation related to such changes. Performance data is based on averages and may vary from machine to machine.

Printed in U.S.A. © 2015 (8 Printco 5000)
GOMACO Corporation Order #RTP-500 Material Placer

Worldwide Headquarters
GOMACO Corporation
PO Box 151
Ida Grove, IA USA 51445
Ph: 1-712-364-3347
www.gomaco.com
E-mail: info@gomaco.com

European Headquarters
GOMACO International Ltd.
Units 14 & 15
Avenue One, Station Lane
Witney, Oxford, OX28 4XZ, England
Ph: 44-1993-705100
E-mail: pavinguk@gomaco.com



The Worldwide Leader in Concrete Paving Technology

GOMACO Corporation's Quality Management System Is ISO 9001 Certified By The American Systems Registrar.

Quality Policy: We Shall Meet Or Exceed Our Customers' Expectations.



The operator's console can move to provide the operator with a panoramic view of the whole placing operation.

CG-061417-D18