

CATALOGUE



For all information and enquiries:

T+32 (0)16 61 85 85

F+32 (0)16 61 84 84

info@cibo.be

www.cibo.be

Author: Dominique Gilles, Emmanuele Filippo

Copywriting: Hanne Machiels

Photography: Bart Strouven

Lay-out: Bart Strouven/Jana Vangoidsenhoven/Hugo Gielen

First impression, January 2011

© Cibo N.V.

No part of this publication may be reproduced or transmitted in any form or by any means, electronic or manual without written permission in advance from Cibo N.V. In the interests of our costumers Cibo N.V. reserves the right to change or modify products without prior notification.

Table of Contents

■ WHO IS CIBO?	12
■ HOW TO READ THE CATALOGUE	16
■ GENERAL INFO	24
■ OVERVIEW TABLE	56
■ BELTS	70
■ DISCS	128
■ SHEETS	186
■ ROLLS	224
■ FLAP DISCS	250
■ FIBRE DISCS	282
■ QUICK CHANGE	296
■ CUTTING AND GRINDING DISCS	314
■ GRINDING WHEELS	320
■ MOUNTED POINTS	350
■ POLISHING MATERIALS	364
■ FOAM	378
■ SLEEVES	384
■ BRUSHES	396
■ HARD METAL BURRS	410
■ MACHINES	418
■ ACCESSORIES	464
■ INDEX	492

WHO IS CIBO? 12

HOW TO READ THE CATALOGUE 16

GENERAL INFO 24

- **Introduction** 27
 - Construction of abrasive materials 27
- **Conventional abrasive materials on flexible base** 29
 - Build-up of material 29
 - Backing 30
 - Glue layer 33
 - Grit 34
 - Grinding aid 38
 - Antistatic technology 39
 - Correct storage pays off 40
 - Choice of joints 41
 - The right choice and application 42
 - Factors influencing aggression 43
 - Factors influencing degree of finish 44
 - Belt speed 45
- **Three-dimensional flexible abrasive materials** 47
 - Specific properties 48
 - Specific abrasive operations 49
- **Three-dimensional semi-flexible grinding materials** 51
 - Convoluted materials 51
 - Unitized materials 52
- **Grit designation** 54
 - Conversion Chart 55

OVERVIEW TABLE 56

BELTS

- **Overview table** 72
- **Paper** 86
 - Aluminium oxide 86
 - Zirconium oxide 88
 - Silicon carbide 88
- **Cloth** 90
 - Aluminium oxide 90
 - Zirconium oxide 106
 - Ceramic 112
 - Silicon carbide 115
 - Trizact™ 117
 - Micro-Mesh 119
 - Cork 120
- **Tex** 122
 - Aluminium oxide 122
 - Silicon carbide 123
- **Surface conditioning** 124
 - Aluminium oxide 124
 - No grit 127

DISCS

- **Overview table** 130
- **Cutting shapes** 144
 - With perforations 144
 - Pre-perforated 145
 - Without perforations/centre holes 146
 - With centre holes 147
 - With centre holes and central slots 148
- **Film** 150
 - Grip discs 150
 - Aluminium oxide 150

- **Paper** 152
 - **Grip discs** 152
 - Aluminium oxide 152
 - Zirconium oxide 158
 - Silicon carbide 160
 - **Double-sided discs** 164
 - Silicon carbide 164
- **Mesh** 165
 - **Discs** 165
 - Silicon carbide 165
- **Cloth** 166
 - **Grip discs** 166
 - Zirconium oxide 166
 - Ceramic 166
 - Finishing Kit 167
 - Trizact™ 168
 - Micro-Mesh 170
- **Tex** 171
 - **Grip discs** 171
 - Aluminium oxide 171
 - Silicon carbide 172
 - CP 173
 - No grit 174
 - **Discs without centre holes** 174
 - Aluminium oxide 174
 - Silicon carbide 175
 - **Discs with centre holes** 176
 - Aluminium oxide 176
 - Silicon carbide 177
 - CP 178
 - Talc 179
 - Silicon carbide (CSD) 179
- **Floorpads** 180
- **Reinforced Tex** 181
 - **Discs without centre holes** 181
 - Aluminium oxide 181
 - **Discs with centre holes** 182
 - Aluminium oxide 182
 - **Abrasive stars** 183
 - Aluminium oxide 183
 - **Fibre discs** 184
 - Aluminium oxide 184
 - **Grip discs** 184
 - T00 184

- **Unitized** 185
 - **Grip discs** 185
 - Aluminium oxide - Silicon carbide 185

SHEETS

- **Overview table** 188
- **Cutting shapes** 200
 - **Deltas grip** 200
 - **Sheets grip** 202
 - **Sheets with PSA fixing** 204
 - **Sheets for parquet industry** 204
- **Film** 205
 - **Grip sheets** 205
 - Aluminium oxide 205
 - **Delta grip sheets** 206
 - Aluminium oxide 206
- **Paper** 207
 - **Grip sheets** 207
 - Aluminium oxide 207
 - **Delta grip sheets** 210
 - Aluminium oxide 210
 - **Sheets** 212
 - Aluminium oxide 212
 - Zirconium oxide 214
 - Silicon carbide 215
 - **Waterproof sheets** 217
 - Aluminium oxide 217
 - Silicon carbide 218
- **Cloth** 219
 - **Sheets** 219
 - Aluminium oxide 219
 - Micro-Mesh 220
- **Mesh** 221
 - **Sheets** 221
 - Silicon carbide 221
- **Tex** 221
 - **Sheets** 221
 - Aluminium oxide 221



○ Silicon carbide	222
○ CP	222
○ GP	223
○ 00	223

ROLLS

● Overview table	226
● Paper	236
○ Aluminium oxide	236
○ Zirconium oxide	240
○ Silicon carbide	241
● Cloth	243
○ Aluminium oxide	243
○ Micro-Mesh	245
● Mesh	246
○ Silicon carbide	246
● Tex	246
○ Aluminium oxide	246
○ Silicon carbide	247
○ CP	248
○ GP	248
○ 00	249

FLAP DISCS

Flap discs for stock removal	253
● Cloth flaps	258
○ Glass fibre backing	258
○ Standard line	258
○ Flat	
○ Conical	
○ Industrial line	259
○ Flat	
○ Conical	
○ Extended	
○ High Performance	260
○ Flat	
○ Conical	
○ Top line	261
○ Extended	
○ Flat	

○ Conical	
○ TAF	262
○ Flat	
○ Conical	
○ Plastic backing	264
○ TAF	264
○ Flat	
○ Conical	
○ Quick Change	266
○ Socatt®	
○ Lockit®	

Finishing discs

● RCD	270
○ Combi flaps	272
● LVT	274
○ Surface conditioning flaps	276
● SAG	278
○ Unitized	280

FIBRE DISCS

● Introduction	284
● Aluminium oxide	288
● Aluminium oxide with grinding aid	290
● Zirconium oxide	291
● Ceramic with grinding aid	293
● Silicon carbide	294
● Overview back-up pads	295

QUICK CHANGE

● General Info	298
● Socatt®	300
○ Aluminium oxide	300
○ Zirconium oxide	302
○ Ceramic	304

○ Silicon carbide	305
○ Tex	305
○ Surface conditioning	306
○ Unitized	307
● Lockit®/Roloc®	308
○ Aluminium oxide	308
○ Zirconium oxide	309
○ Ceramic	310
○ Tex	311
○ Surface conditioning	311
○ Unitized	312
● Overview supports	313

CUTTING AND GRINDING DISCS

● Cutting discs	316
○ Top line	316
○ Standard line	317
● Grinding discs	318
○ Top line	318
○ Ceramax	319

GRINDING WHEELS

● With centre hole	322
○ Cloth	322
○ Tex	326
○ CSD	329
○ Combi	330
○ Convolute	332
○ Unitized	334
● Spindle mounted	338
○ Cloth	338
○ Tex	342
○ Combi	345
○ CSD	348
○ Unitized	349

MOUNTED POINTS

● Shapes	352
● Spindle mounted points	356
○ White corundum	356
○ Pink corundum	356
○ Black corundum	357
○ Grey / Silicon carbide	357
● Mounted points	358
○ Reinforced cotton or unitized?	358
○ Reinforced cotton	359
○ Unitized	361

POLISHING MATERIALS

● Introduction	366
● Polishing wheels	366
○ Sisal	366
○ Sewn	366
○ Cotton	366
○ Single	366
○ Sewn	367
○ Ventilated	367
○ Flannel	368
○ Sewn	368
○ Ventilated	368
● Finimaster wheels	370
○ Finimaster basic and other satinising machines	370
○ Sisal	370
○ Cotton	370
○ Felt	370
○ Finimaster pro	370
○ Cotton	370
○ Flannel	371
● Felt discs	371
○ Velcro backed	371
○ M14	371
● Felt wheels	372
● Mounted felt points	372

○ Straight	372
○ Conical	372
○ Point	373
○ Ball	373
● Compound sponges	374
● Lambswool	374
● Polishing bars	375
● Liquid polishing paste	376
● Inoxiclean (Vienna chalk)	376

FOAM

● Sanding blocks	380
● Foam blocks	380
● Foam pads	381
● Hi-flex pads	381
● Easy-Foam	382
● A275-Foam	383

SLEEVES

● Spirabands	386
○ Spiral	386
○ Zirconium oxide	386
○ Aluminium oxide	388
○ Sleeves	389
○ Aluminium oxide	389
○ Zirconium oxide	389
● Cartridge rolls	390
○ Straight	390
○ Tapered	391
● Abrasive caps	392
○ Flat	392
○ Round	393
○ Point	394
○ Conical	395
○ Cone	395

BRUSHES

● Steel wire brushes	398
○ Wheel	398
○ With centre hole	398
○ Spindle mounted	398
○ End	400
○ Spindle mounted	400
○ Cup	400
○ Spindle mounted	400
○ M14	401
○ With centre hole	401
○ Bevel	402
○ M14	402
○ Hand brushes	402
● Stainless steel wire brushes	403
○ Wheel	403
○ White centre hole	403
○ Spindle mounted	403
○ End	404
○ Spindle mounted	404
○ Cup	405
○ M14	405
○ Hand brushes	405
● Grittyflex brushes	406
○ Wheel	406
○ Spindle mounted	406
○ End	406
○ Spindle mounted	406
○ Cup	406
○ Spindle mounted	406
● Schmilon brushes	407
○ Wheel	407
○ With centre hole	407
○ Tube	407
○ Spindle mounted	407
● Reduction rings	408

HARD METAL BURRS

● Cylinder	412
● Cylinder + end cut	413
● Bull nose	413

● Ball	414
● Oval	414
● Round tree	415
● Pointed tree	415
● Flame	416
● Counter sink 60° - 90°	416
● Ball nosed cone	417
● Cone	417

MACHINES

● Finitube	421
○ Accessories	426
● Finit-Easy	429
○ Accessories	436
● Finimaster Pro	439
○ Accessories	444
● Finimaster Basic	448
○ Accessories	450
● Finipower	456
● Inline grinder	456
● Pipetuner	458
○ Accessories	459
● Polishing mills	460
● Finiflex	461
○ Accessories	461

ACCESSORIES

● Ventilated wheels	466
● Inflatable wheels	467
● Finimaster accessories	468
● Lockit®/Roloc® supports	470
● Socatt® supports	471
● Back-up pads for angle grinders	472

● Interlayer foam - heat-resistant	473
● Back-up pads for eccentric grinders	474
● Back-up pads for flexible shafts & drill machines	475
● Fibre back-up pads for angle grinder	476
● Shafts and spindles	477
● Reducing flanges	482
● Reducing rings	484
● Flanges for angle grinders	485
● Stainless steel flanges for Finit-Easy	485
● Mandrels	486
● Spira supports	487
● Hand sanding systems	488
● Spray glue	489
● Inoxiclean	489
● Inoxtape	490
● Wool felt	491
● Graphite cloth	491
● Drive belts for finishing machines	491

INDEX 492



▸ Who is Cibo?

Cibo is a unique solution provider for technical grinding problems. To achieve this goal for its customers, Cibo unites a combination of 3 important elements.

Cibo has a near inexhaustible supply of technically advanced grinding and polishing products at its disposal.

Secondly, Cibo develops highly specific grinding machines that improve the quality of the finish and simultaneously improve user-friendliness for the operator.

And finally, Cibo shares its tremendous application know-how with all its customers, completely free of charge.

Each Cibo application expert has years of experience in the field, and additionally is provided with ongoing and intensive refresher courses at the Cibo training centre.

By processing grinding materials in inventive ways, and by coming up with clever combinations of various materials, Cibo succeeds, time and again, in creating innovative grinding products. The emphasis lies in saving time for the users and a high level of user comfort.

With a driven and passionate team, Cibo is at its clients' disposal to come up with and put into practice the most efficient solution for any grinding problem.





**Cibo is looking
for trouble!**

➤ **Cibo is looking for trouble**

Yes, you've read this correctly. Cibo is looking for trouble! Not with you of course.

No, trouble relating to the finish of, amongst other things, stainless steel and special alloys.

Problems with obtaining the desired finish? Finishing costs much higher than expected? Or does the finish of that inner corner appear impossible?

In that case, please contact Cibo as quickly as possible! As these are the kind of difficulties we thrive on.

No grinding problem or challenge is too daunting for us. It doesn't matter whether we are dealing with a case of quick machining, a decorative, functional or high-gloss finish or a cost reduction in the grinding process.

After all, Cibo can always count on the following:

- *A team of passionately driven application experts, with years of experience in the field. Their extraordinary knowledge of applications takes into account not only all important parameters like speed, work pressure, throughput speed, grinding contact, etc., but also the working conditions, the available tools, the operator's know-how, etc.
Our finishing specialists will come to your location, with no obligation, and show you that with our innovative products, problems with any kind of finish are a thing of the past.*
- *A permanent stock of more than 10,000 technically advanced grinding materials in our Tildonk branch.*
- *An extensive workshop where customisation is the norm and where Cibo is constantly coming up with new and innovative solutions.*
- *Unique tools, developed in-house, that will lift your finish to the next level, guaranteed.*



HOW TO READ THE CATALOGUE

➤ How to read the catalogue

To make it easy for you, we have divided all our products in this catalogue into categories, according to their shape.

We can distinguish :

- | | |
|---|--|
| ■ BELTS | ■ MOUNTING POINTS |
| ■ DISCS | ■ POLISHING MATERIALS |
| ■ SHEETS | ■ FOAM |
| ■ ROLLS | ■ SLEEVES |
| ■ FLAP DISCS | ■ BRUSHES |
| ■ FIBRE DISCS | ■ BURRS |
| ■ QUICK CHANGE | ■ MACHINES |
| ■ CUTTING AND GRINDING DISCS | ■ ACCESSORIES. |
| ■ GRINDING WHEELS | |

All product groups have their own colour, so they are easy to find.



SCHEMATIC OVERVIEW

Each chapter is preceded by a schematic overview of the division within each product group.

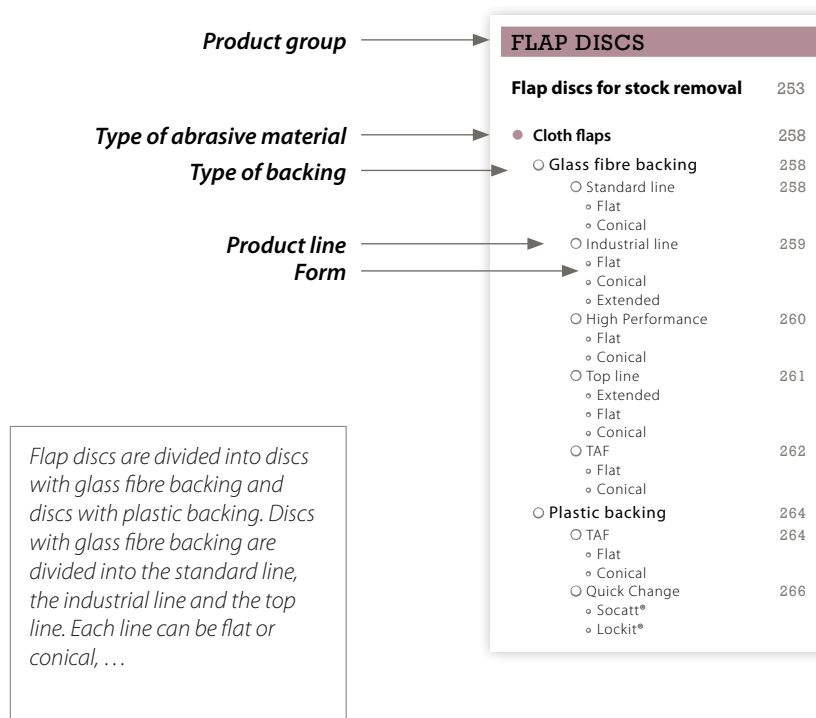

After this schematic overview, a brief introduction is provided for the product group. Here you will find information about the product applications, the ideal conditions for use, certain tips about the use of the products, etc.

➤ PRODUCT TABLE SCHEMA

All chapters are subdivided into groups. This subdivision is structured in exactly the same way for all product groups. The main group is named in the table heading. The coloured frames left or right of the table are subgroup 1 and subgroup 2 (in case a second frame is present). At the end, you will find the last subdivision, the type of product, in the grey heading.

In order to help you choose a product from our extensive range, the properties of each product are indicated below the type of product, as well as what the products can be used for.

Chapter → **FLAP DISCS** | Finishing discs

Main group → **Combi flaps / Glass fibre backing**

Subgroup 1 → **TOP LINE**

Subgroup 2 (if applicable) → **RCD - CONICAL**

Type of product. →  **RCD**

Available variants →

dimensions	grit	code	type	max RPM	advis RPM
Ø 115x22	XC	RCD/XC/115	Al-Ox.	13200	6500
	CO	RCD/CO/115	Al-Ox.	13200	6500
	ME	RCD/ME/115	Al-Ox.	13200	6500
	VF	RCD/VF/115	Al-Ox.	13200	6500
Ø 125x22	XC	RCD/XC/125	Al-Ox.	11000	5500
	CO	RCD/CO/125	Al-Ox.	11000	5500
	ME	RCD/ME/125	Al-Ox.	11000	5500
	VF	RCD/VF/125	Al-Ox.	11000	5500
Ø 180x22	XC	RCD/XC/180	Al-Ox.	6000	3000
	ME	RCD/ME/180	Al-Ox.	6000	3000

Properties:

- Controlled material removal
- Even finish
- Constant and low Ra-value
- Shock dampening effect
- Lower heat generation
- Very broad applications: Stainless steel, aluminium, soft metals, s

Applications:

- Finishing light weld seams
- Finishing angles and tooothing
- Improving the surface roughness
- Refining coarse grinding lines
- Breaking edges
- Grinding down casting errors
- Etc.

Additional information or tips →  The optimal rpm for working with the RCD-disc is 3,600 to 6,000 RPM. This way you can prevent areas being burnt, the disc has a longer lifespan and you can maintain absolute control of the grinding process.

A green dot next to the item number indicates that this item is in stock. These items are always immediately available. The items with a blue dot next to the item number are manufactured to order. For these items, shipping time is about 5 working days.

An orange dot shows that the terms of delivery for these items always has to be confirmed by Cibo. The terms of delivery can vary from 1 day to 12 weeks depending on the conditions and the product you need.

LEGEND: STOCK STATUS

● = available from stock

● = available within 5 working days

● = on request

Abrasive caps

ABRASIVE CAPS CONICAL

Properties:

- Very efficient for all grinding and deburring operations in hard-to-reach locations
- Working with crosscut side also possible
- Quick change
- Available in various widths and thicknesses

Applications: Tool manufacture, moulds, precision mechanics, making models and miniatures, aerospace industry, etc.

diameter	height	grit	code	type	code holder	stock	
Ø 16	32	60	SKC/60/1632	Al-Ox.	SKCH1632	●	25
	32	80	SKC/80/1632	Al-Ox.	SKCH1632	●	25
	32	150	SKC/150/1632	Al-Ox.	SKCH1632	●	25
Ø 21	40	60	SKC/60/2140	Al-Ox.	SKCH2140	●	25
	40	80	SKC/80/2140	Al-Ox.	SKCH2140	●	25
	40	150	SKC/150/2140	Al-Ox.	SKCH2140	●	25

Stock status

Packing unit



Are you looking for a product in a specific material or with measurements that are not mentioned in our catalogue? No problem! Made to order is the norm here at Cibo! In our Tildonk branch, we have a permanent supply of more than 10,000 technically advanced grinding and sanding materials in stock, along with an extensive production plant, where we can manufacture abrasive materials in all shapes and sizes within five working days.

➤ BELTS, DISCS, SHEETS & ROLLS

The layout of the belts, discs, sheets and rolls chapters deviates slightly from that in the other chapters in this catalogue.



Given the fact that we can manufacture belts, discs, sheets and rolls in practically any material and size, the catalogue displays the most common sizes. Does the catalogue show a certain belt type, disc, sheet or roll you wish to purchase in another material, or do you require a different size? Please do not hesitate to contact our Cibo colleagues, your order can be made tot order within 5 working days.

Belts, discs, sheets and rolls are all manufactured from the same basic materials. At the start of each chapter, you will see a total overview of the available basic materials: paper, cloth, tex and reinforced tex. This diagram contains, amongst other things, the weight of the backings, the grit size range per type of material, the top coating













applied to the material, the water resistance of the material, the properties of the various materials and an extensive overview of the applications for each type of material.

Each of these chapters starts with an overview of various applications. This diagram lists the most recommended sizes for those applications. Simply look at the material you want to work on and you will be referred to the page where you can find the desired product. Caution: this label only displays the grades that are most suited for that specific application according to Cibo. If you still require a more elaborate overview, it is best to return to the total overview of the available basic materials at the start of these four chapters.

- 1. Select the application
- 2. Select the backing
- 3. Select the type

Application	Type	Backing	Weight	Type of grit	Top Coating	Waterproof	Maximum width	Grit size type
 Soft wood	Cloth	QNSH	Mesh	-	S/C	-	910	40-60-80-100-120-150-180-220-320
	Tex	A/O	Nylon web	-	A/O	-	1500	A-Coarse - A-Medium - A-Fine - A-VERY STRONG - A-Very Fine SOFT - A-Very SUPERSOFT
 Glass & stone	Paper	SP706F	Paper	F	S/C	-	1450	Grip: 24-36-40-60-80-100-120-150-180-220-240-280-320-400-500-600-800-1000 Without grip: 24-36-40-50-60-80-100-120-150-180-220-240-280-320-400-500-600-800-1000-1200
	Tex	00	Nylon web	-	Talc	-	1500	No grit
 Plastics & Rubber	Cloth	MFR	Cotton	F	Calibrated A/O	-	500	MFR1500 (P600)-MFR1800 (P1200)-MFR1500 (P1500)-MFR3200 (P2500)-MFR3600 (P4000)-MFR6000 (P5000)-MFR6000 (P6000)-MFR12000 (P8000)

▶ APPLICATION SYMBOLS

 Metal	 Aluminium	 Plastic & Rubber
 Stainless steel	 Hard wood	 Car repair
 High quality alloys	 Soft wood	 Lacquers & Varnishes
 Non-Ferrous	 Glass & Stone	 Leather

Materials in colour = Recommended materials
 Materials in grey = Possible materials



	Properties	Page
400-600	Open polyester web structure to which grit is anchored on both sides.	
Very Fine Fine	The nylon fibres are combined into a three-dimensional web structure using thermo-setting synthetic resin, and are available in various grit types with an aluminium oxide grit. The result is an elastic abrasive material with an open structure that is easy to use and provides an even and constant finish. The tex material does not affect the geometrical shape of the work pieces. A/O creates a good long-lasting finish at high speeds.	
20-220-320- -1200	Antistatic silicon carbide grit on a very strong "F" base. Ideally suited for use in sanding wooden floors and parquet.	
120-150- 400-500-	With the TEX 00, the nylon fibres are combined into a three-dimensional web structure using thermo-setting synthetic resin without abrasive grit. This material does not scratch and is ideally suited for cleaning.	
MFR2400 (P3000)- MFR8000	Micro-Mesh is a concept whereby extremely precisely calibrated grit crystals can be deftly placed in a flexible latex layer on a supple cotton base. Due to the elastic positioning, this grit always comes in contact with the workpiece at a positive angle. This ensures a constant and even scratch depth. This ingeniously thought out design guarantees an extremely even, constant and precise finishing pattern.	

GENERAL INFO

- **Introduction** 27
 - Construction of abrasive materials 27
- **Conventional abrasive materials on flexible base** 29
 - Build-up of material 29
 - Backing 30
 - Glue layer 33
 - Grit 34
 - Grinding aid 38
 - Antistatic technology 39
 - Correct storage pays off 40
 - Choice of joints 41
 - The right choice and application 42
 - Factors influencing aggression 43
 - Factors influencing degree of finish 44
 - Belt speed 45
- **Three-dimensional flexible abrasive materials** 47
 - Specific properties 48
 - Specific abrasive operations 49
- **Three-dimensional semi-flexible grinding materials** 51
 - Convolute materials 51
 - Unitized materials 52
- **Grit designation** 54
 - Conversion Chart 55

GENERAL INFO





GENERAL INFO

➤ Introduction

Abrasive materials on a flexible backing are used in nearly all sectors of the processing industry. The best known application for many years has probably been for woodwork. A wide variety of applications in addition to this was later developed. These applications are mostly situated in the metallurgical sector in the broad sense of the word, but very advanced applications also exist for working stone, glass, plastics and leather.

Without flexible abrasive materials there would be no cars, trains or airplanes, no computers, no petroleum refineries, no houses, furniture or interiors, no medical implants; there would be no surgery, sanitation or design; and the list goes on and on. In short, without flexible abrasive materials our daily lives would be completely different.

➤ CONSTRUCTION OF ABRASIVE MATERIALS

The development of flexible abrasive materials has continued over the years.

Hence the current abrasive materials on a flexible backing are of a high technical standard. New grit types, new and improved bases, sophisticated resins and high-tech active abrasive ingredients provide each product with highly specific and advanced properties.

We can distinguish **2 large families**:

- **conventional abrasive materials on a flexible backing (p. 29)**
- **three-dimensional abrasive materials (p. 47)**



- **Conventional abrasive materials on flexible base**
 - Build-up of material
 - Correct storage pays off
 - Choice of joint
 - The right choice and application



➤ Conventional abrasive materials on flexible base

➤ BUILD-UP OF MATERIAL

The classic abrasive materials are built up in layers. The ingenious construction of the various layers determines the technical properties and the final quality of the end product. In principle, a conventional abrasive material consists of 4 to 5 layers. The lowest layer is the backing. The various backings largely determine the flexibility and the strength of the abrasive material. A glue layer is applied to the backing. Subsequently, the grit is spread onto the glue layer. An ingenious technique ensures that the grit with the sharpest edge is always placed uppermost in the glue layer. The various materials of which the grit consists determine the area of application of the abrasive material. Another

glue layer is applied on top of the grit to optimally anchor the grit to the backing. A grinding aid can also be applied as a top layer. This top coating ensures the grinding dust is properly removed during use, and also provides a cooling effect.

In the next pages you will find information about which parameters determine the properties of the different abrasive materials and how you can select the material that is best suited for your application.

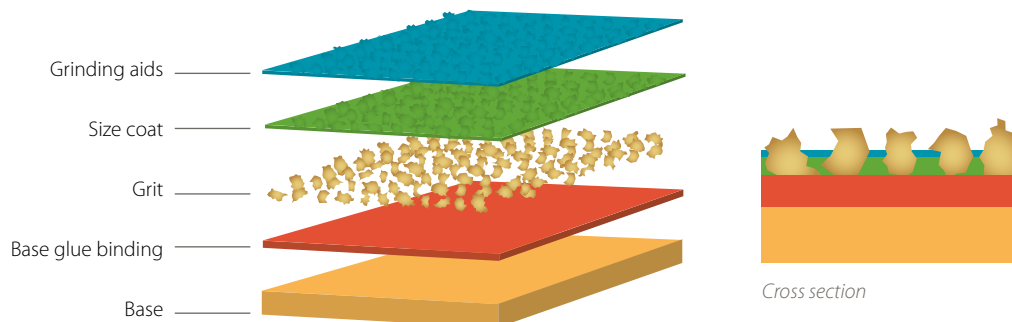

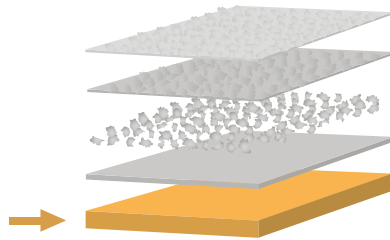

Cotton

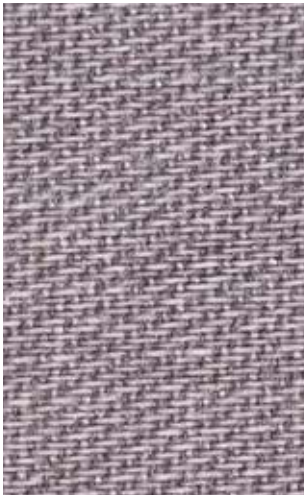

Polyester



BACKING

Cotton and polyester

Cotton and polyester bases are reasonably tear-resistant and durable. For that reason, they are mainly recommended for use with heavier and/or specific technical applications. Their properties are indicated with a letter.

F-base :

This backing is highly flexible and is primarily used for manual applications, in the shape of rolls or sheets.

J-flex and **J**-base :

This is a highly flexible cloth, but with specific technical properties for use in continual grinding belts. The backing is primarily used for work where the finish is more important than removal of material. Grinding cloth with a J-base is most often used in combination with softer contact wheels or grinding shoes at low pressure.

X-base :

The X-backing is the most universal. It is used for both coarse and fine grit and is usually only suitable for dry use. The X-cotton, however, can also be treated so that it is water-resistant and can be used with cooling liquids. You will find these in the overview with the code X/W.

H-base

This is a polyester backing with an average hardness. Polyester is very difficult to tear, it is resistant to heavier loads and can be used both wet and dry. It is a very stable base.

Y-base

This backing is heavier than the "H" version and is primarily used for highly demanding applications, where heavy to extremely heavy machining is required. This version can be used both wet and dry.

Polyester cotton

The last few years we have seen more and more backings consisting of a mixture of polyester and cotton. These backings exist in the "J", and "J-Flex" versions, as well as the "X". Generally, they are less sensitive to stretching and they are better suited to resisting tearing than the same type of cotton bases.



Did you know that sand paper is not always just sand paper? Very often, what is called sandpaper in common parlance is not paper but abrasive cloth. A base or backing can consist of paper or cotton. There are film bases and mesh bases; there are classic abrasive materials or three-dimensional grinding structures; there are grinding sponges... the list goes on! That is the reason why we at Cibo always use the term flexible abrasive materials, as this term covers the entire range.

BACKING

Paper

The weight of the paper is an important factor in determining the flexibility and the resistance against tears. The weight is shown by the letters "A" through "F", with "A" standing for the lightest paper and "F" for the heaviest.

A-paper:

80-85 gr/m²: light and flexible. Is only used with manual applications, both wet and dry and for finer grit types (grit 150 and finer).

B-paper:

90-105 gr/m²: is not used very often any more.

C-paper:

110-125 gr/m²: is less flexible than A-paper and is used, amongst other things, for manual applications. Usually, we find C-paper with velcro for use on light hand machines (discs, sheets, deltas).

D-paper:

150-180 gr/m²: this paper has a reasonably strong backing and is generally used for light hand grinding machines or for manual grinding.

E-paper:

220-250 gr/m²: this paper with a tough backing is fairly resistant to tearing and, until recently, was the standard for use in heavier applications, such as discs, belts and wide belts.

F-paper:

250-300 gr/m²: E-paper seems to be gradually disappearing and is being replaced by an F-base, certainly with coarser grit types. This backing is ideally suited for heavier applications and wide belts.

Paper





Film

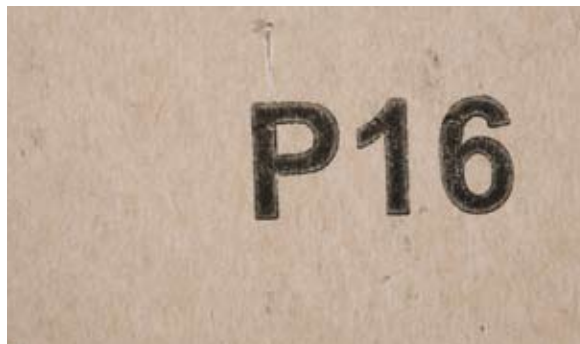

Combination

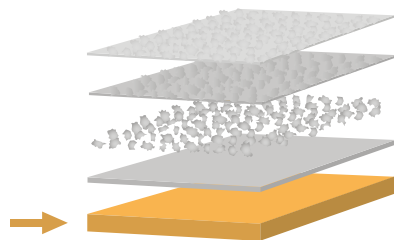

BACKING

Film

Recently, new grades have appeared with a film bottom layer. The film bottom layer is very similar to the C paper in terms of flexibility. The film material, however, can be used either wet or dry and it is highly tear resistant.

Fibre

This backing is made from multiple layers of impregnated paper. Fibre is reasonably inflexible, hard and tear-resistant. It is primarily used for the production of grinding discs. In the production of abrasives with a coarser grit where a heavier and faster action is important, a thickness of 0.08 mm is used. For finer grit, thicknesses up to 0.65 mm are current, but Cibo discs always are 0.8 mm thick. Fibre discs always have to be used with a suitable back-up pad.

Combination

Combination bases consist of E or F paper reinforced with a light film to prevent tearing. A combination of grades is most often used in coarse grit with an open grit structure, for the grinding of old floors and parquet. In addition, wide belts are used in the chipboard industry.

Mesh

Mesh is an open polyester web structure to which grit is anchored on both sides. Due to its unique structure, this material is not easily saturated. It is therefore very suitable for the grinding of paints, lacquers, varnishes, filler,...



Fibre

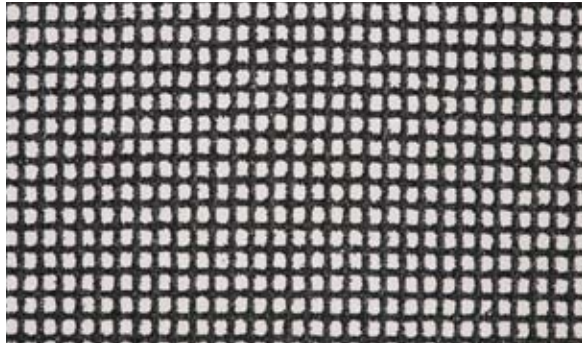

Mesh

GLUE LAYER

Animal glue

- Very flexible
- Not moisture-resistant
- Very limited resistance against heat build-up
- Weak grit binding

Synthetic resin binding

- Less flexible than animal glue
- Heat-resistant
- Moisture-resistant
- Very strong grit binding
- After application of the first layer of glue in which the grit is anchored, a first polymerisation takes place. Afterwards, the second layer of glue is applied.

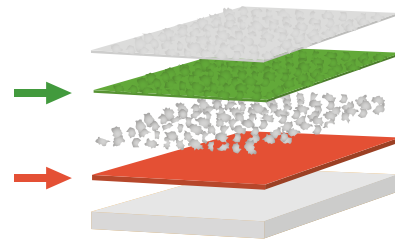

GRIT

The stock removal capacity of the grit is determined by its shape, structure, hardness, toughness, fragility, heat-resistance and orientation.

The hardness of a grit is usually determined according to **the Mohs scale** and/or **the scale of Knoop**. On the opposite page you will find a comparative scale of the most important grit types.

Besides its hardness, the toughness or fragility of the grit is possibly even more important for the evaluation of a grit efficiency in a specific application. The more fragile the grit is, the less pressure is required to break it and create new, sharp

cutting edges. Less pressure leads to lower heat generation and an improved level of finish. A higher level of fragility is, in turn, responsible for a shorter lifespan. In the list on the next page, you can read which grit types are the quickest to break.

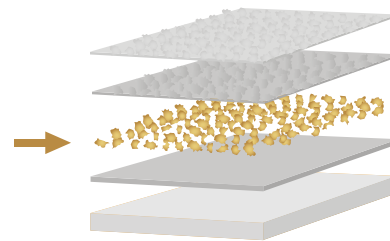

Mohs-Knoop hardness scale

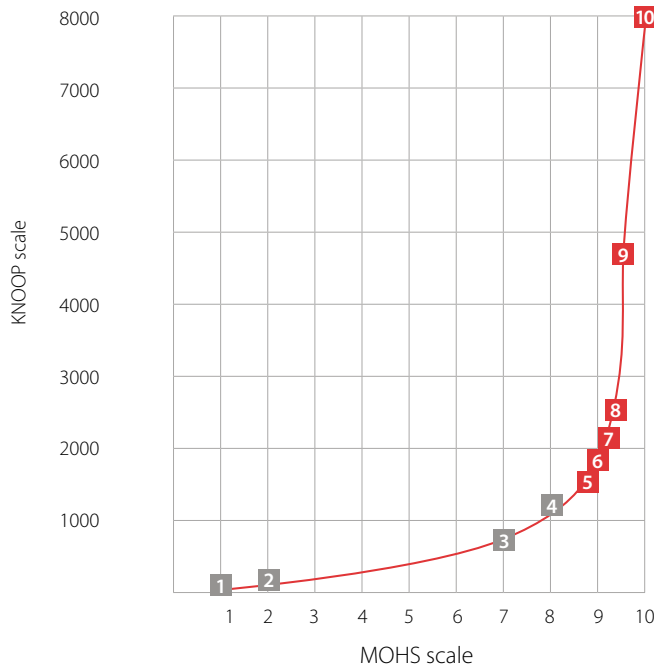

Mohs	Knoop	Grit
1	100	Talc
2	150	Gypsum
3	820	Quartz
4	1100	Topaz
5	1600	Zirconium/Aluminium oxide
6	1950	White aluminium oxide
7	2100	Ceramic aluminium oxide
8	2480	Silicon carbide
9	4700	CBN 4700
10	8000	Diamond

■ = common grit types

Scale fragility / toughness

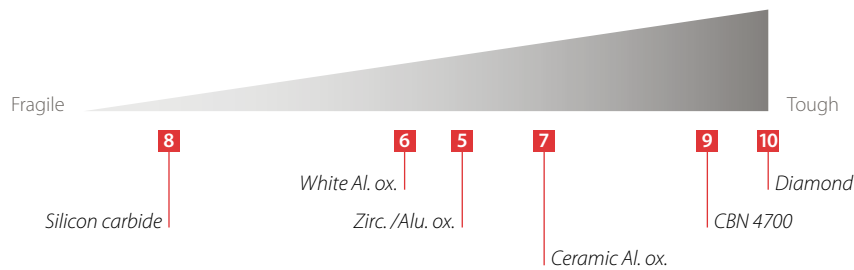

GRIT

Types

There are 3 grit types.



The conventional or singular grit type



The compact or composite grit type



The geometrically composed grit type

Trizact™ / Norax™

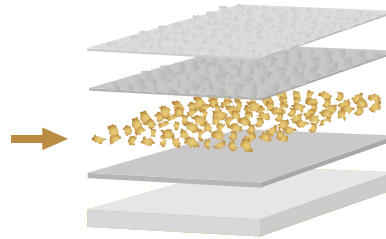

GRIT

Types

Aluminium oxide



Aluminium oxide has a simple, crystal structure, and is, on average, hard and abrasion-resistant, but

it is less sharp than other grit. Aluminium oxide is less tough than zirconium oxide and therefore requires less pressure. Heat generation can rise significantly when this grit is used. It is therefore better to use aluminium oxide with metals that are heat-resistant.

Zirconium oxide



The zirconium oxide grit is medium hard, but is very sharp, very tough and has a good resistance against

heat. This makes it the ideal grit for heavy machining under heavy to very heavy pressure. Due to the heavy pressure and under the influence of heat, the grit breaks open and this constantly creates new cutting edges. This prevents the grit from becoming blunt prematurely. The zirconium oxide grit achieves its best performance with coarser grit (24-80).

Silicon carbide



This grit is definitely the hardest and sharpest in the range, but it is also very fragile. This rather limits its

lifespan. On the other hand, due to its hard and sharp properties, it is ideally suited for working titanium and cobalt alloys, such as Inconel. Silicon carbide also provides very good results on glass and stone. Due to its specific properties, little pressure is required to work efficiently with this grit type. As a result, little heat is generated. Silicon carbide is an ideal partner for working heat sensitive materials such as most non-ferrous materials, copper, brass, bronze, aluminium, etc., but also plastics, rubber, chipboards and MDF.

Ceramic grit



Ceramic grit has a micro-crystalline structure and is hard and tough, but at the same time it is also

sharp. Due to the micro-structure, the grit already starts to break under low to medium pressure. The new cutting edges make sure the machining capacity of the grit diminishes little during the belt's lifespan. The properties of the ceramic grit can, however, change in an adverse way under the influence of heat. For this reason, active grinding ingredients preventing heat build-up are often added to this grit.

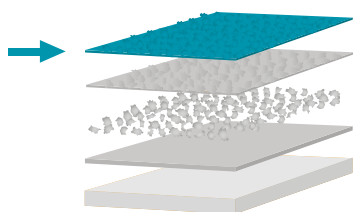

GRINDING AID

Grinding aids are used to try to reduce heat generation during the grinding process, to prevent the grit from becoming saturated and to improve the abrasive properties of the abrasive material.

- **Zinc stearate:** this coating is applied on top of the top glue layer and reduces friction with the grinding surface. This causes the grit to absorb less quickly and makes it possible to grind with reduced heat generation.
- **Chemical coatings:** usually based on potassium or sodium. These coatings are either added to the top glue layer or as a third coating after the top glue layer has been applied. Primarily, these minerals have the capacity to prevent the buildup of heat and contamination. This has a positive impact on the performance of the abrasive material.

ANTISTATIC TECHNOLOGY

During the grinding process, the abrasive material is positively loaded, while the machine, the grinding belt and the workpiece are negatively loaded. This is primarily the case for grinding wood, polyester, lacquers, varnishes, etc. (bad conductors). This is the reason why the abrasive material sticks tightly to the grinding machine and belt as well as to the workpiece. As a result, it is difficult to remove and vacuum the dust. Sandpaper which is manufactured using antistatic production technology prevents the grinding dust from being electrically loaded. This makes it a lot easier to vacuum the grinding dust.

The advantages are therefore obvious :

- Longer lifespan of the grinding belt because it does not become quickly saturated.
- Increased cutting capacity of the grit
- Better level of finish
- Lower maintenance and energy costs
- A healthier and more pleasant working environment



All paper grinding belts provided by Cibo were perfected using antistatic technology.



CORRECT STORAGE PAYS OFF

Abrasive materials on a flexible base are extremely sensitive to proper storage. More often than not, this receives too little attention. Nevertheless, proper storage pays off immediately. This will considerably increase the lifespan and the performance of your abrasive material.

● **Conventional abrasive materials on flexible base**

- Build-up of material
- Correct storage pays off
- Choice of joints
- The right choice and application

- Ambient temperature: 16 - 24 °C
- Relative humidity: 40 - 70 %
- Never store directly on a stone base or concrete floor.
- Never store in the vicinity of windows or outside doors.
- Never expose to direct sunlight, heat or freezing temperatures.
- Store in original packaging until use.
- Once unpacked, store in such way that distortions are prevented.

➤ CHOICE OF JOINTS

The quality of the finish is determined to a large extent by the correct selection of the joint. At Cibo, you have no fewer than 6 different joints to choose from. Cibo designs its joints automatically according to the selected quality of the abrasive material, the grit and the application. Simply on request, Cibo will create a design based on your specific requirements, as indicated below.

Overlap-ST

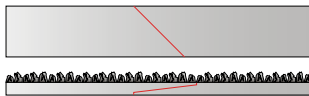

This is the standard joint for all grinding belts on a paper backing. With this type of joint, Cibo guarantees a joint

without any thickness, resulting in a perfect finish, even when using very fine grit types.

Overlap-EX

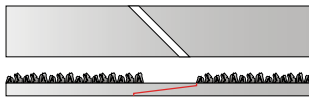

Identical to overlap ST, but with completely ground-away upper side.

BB

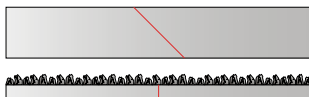

Cibo chooses this type of joint for all grinding belts on a cloth and polyester backing. The Kevlar tape

used is available in several variations and thicknesses and is adapted to the selected grit type, the base type and the angle of the joint. This joint guarantees a perfect grinding result and allows you to use the grinding belt in either direction, without any risk.

BB-ZZ

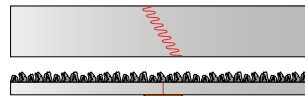

Also called a finger joint or dovetail joint. Both ends of the joint are put together in a zigzag shape and

reinforced along the back with Kevlar tape. This joint is generally used for very fragile applications, e.g. grinding thin types of glass.

BB-EX

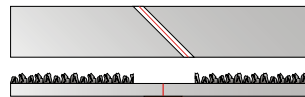

Identical to BB joint, but with ground-away upper side. The upper side is ground away 5 mm more

than the underlying Kevlar tape. This joint is sometimes useful when working on very hard material on an extremely hard grinding surface.

BB-SO

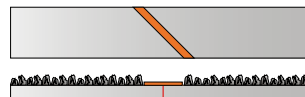

BB joint whereby the Kevlar tape is applied along the top instead of the bottom.

For this purpose, a strip of grit the width of the Kevlar tape is removed off the upper side.



● **Conventional abrasive materials on flexible base**

- Build-up of material
- Correct storage pays off
- Choice of joint
- **The right choice and application**

➤ **THE RIGHT CHOICE AND APPLICATION**

The best grinding result is achieved through correct analysis of the working environment. In order to select the most suitable abrasive material, it is therefore also very important for the primary user parameters to be set correctly or be known.

Important parameters:

- The material to be ground
- The desired level of finish
- The number of intermediate steps
- The base material
- The binding
- The grit size
- The grit type
- Whether or not grinding aids are present
- The hardness, type and diameter of the wheel
- The circumference speed or the belt speed
- The throughput speed or movement of the workpiece
- The pressure exerted
- The use of cooling agents
- The shape to which the abrasive material is to be applied.
- The available machines and their capacity
- The grinding motion



Did you know that saving time is a concept that has been important to Cibo for many years? In the development of new abrasive materials, strong emphasis is placed on saving users' time. Only the best will suffice for Cibo customers. That is why all Cibo products have been tested extensively, and we offer only those products that provide the best performance in terms of price and quality.

Factors that influence the aggression of flexible abrasive materials



Factors that influence the level of finish of the workpiece

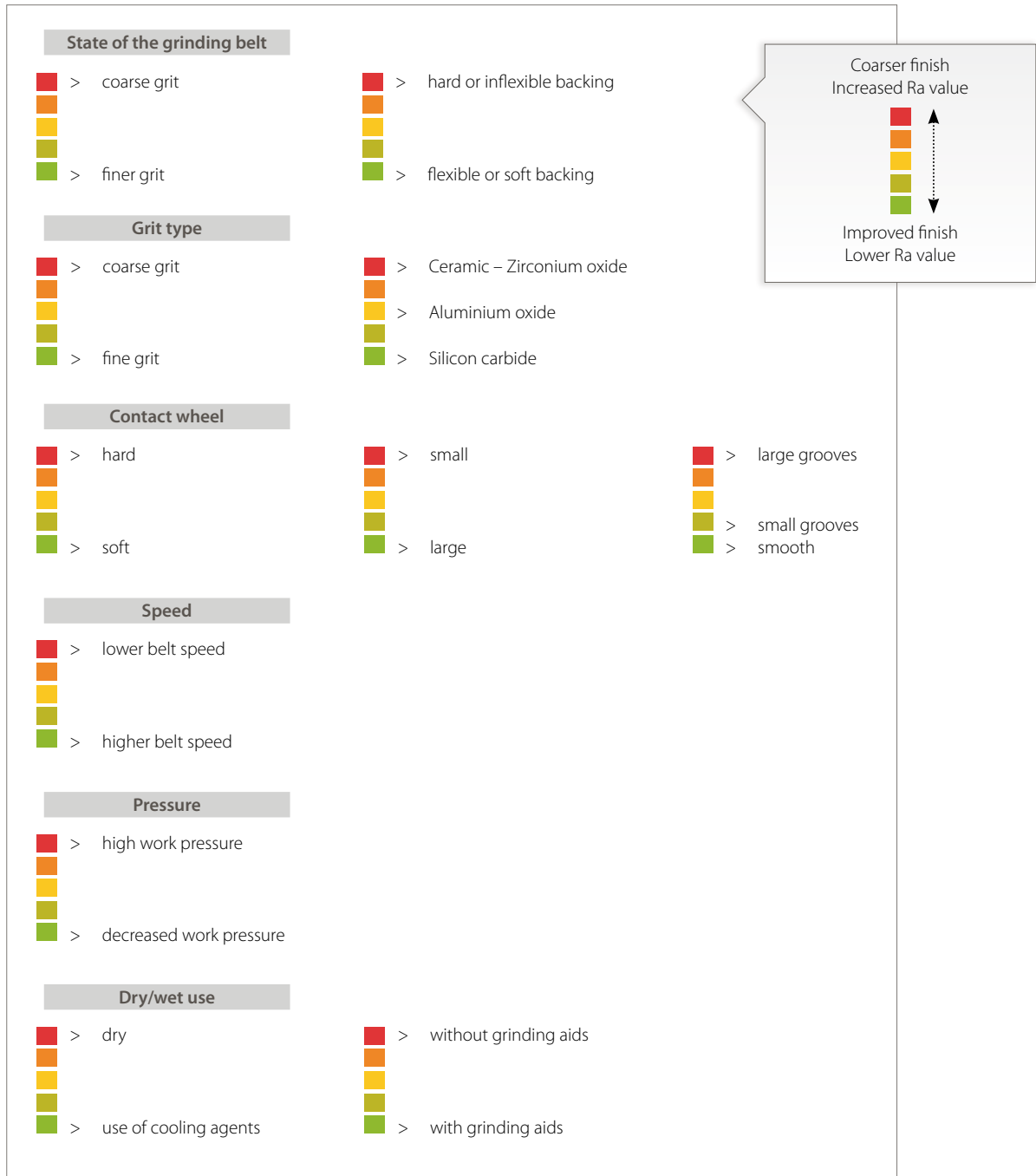

Belt speed

The belt speed is a very important parameter. It has an impact on the abrasive capacity, the lifespan of the grinding belt, the heat generation and the quality of the finish. The table alongside contains the belt speeds recommended by Cibo for a number of materials to be worked.

	Material to be worked	Belt speed in m/second
	Stainless steel, tool steel, high speed steel	18 – 30 m/s
	Cast iron, carbon steel	25 - 45 m/s
	Non-ferrous metals, copper, brass	25 - 35 m/s
	Aluminium, zinc	18 – 30 m/s
	Hard and hardened steel	8 – 15 m/s
	Titanium and titanium alloys	10 – 25 m/s
	Glass, ceramic materials, stone	8 – 14 m/s
	Plexiglass	5 – 14 m/s
	Synthetic materials and plastic	10 – 18 m/s
	Wood	15 – 25 m/s
	Lacquers, varnishes	8 – 15 m/s



Did you know that Cibo works with a team of enthusiastic consultants? These people have been active in the world of abrasives for many years and come into contact with grinding situations every day. With their extensive know-how, they take into account not only all important parameters, such as speed, work pressure, throughput speed, and grinding contact, but also the work environment, the available tools, the operators' know-how, etc. On top of that, their advice is entirely free! Do you have a question about a grinding problem for which you cannot find a solution? In that case, please do not hesitate to contact Cibo on phone number +32 16 61 85 85, or send an email to info@cibo.be. We will put you in contact with the consultant in your region.





- **Three-dimensional flexible abrasive materials**

- Specific properties
- Specific sanding work

▶ Three-dimensional flexible abrasive materials



Tex (nylon)

Nylon fibres are combined into a three-dimensional web structure using a thermo-setting synthetic resin. Grit is anchored in the synthetic resin. The result is an elastic abrasive material with an open structure. This tex abrasive material tears easily and has limited mechanical resistance. It is mostly used for manual applications in the form of sheets and rolls. The tex material does not affect the geometrical shape of the work pieces.



Nylon Floorpads

This nylon is made from a very thick web structure and was specially designed for cleaning or polishing floors. For this purpose, discs are placed under a special floor grinding machine. This quality is made in various colours. Each colour stands for a specific grade of abrasiveness. The darker the colour, the more abrasive the grade. Thus, black is the coarsest and white the softest quality.



Reinforced tex (Surface conditioning)

Reinforced tex is an open nylon web, permeated with grit, which is anchored on a woven polyester structure. This provides the material with greater resistance against stretching and tearing and can also be used to create endless grinding belts.

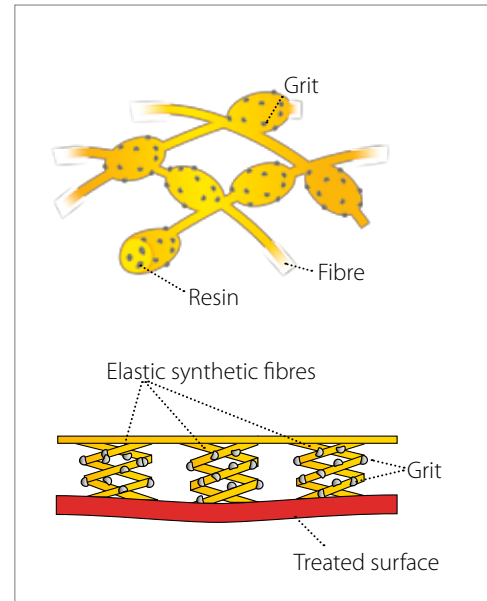

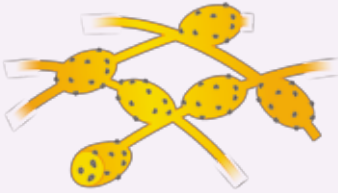

➤ SPECIFIC PROPERTIES

Three-dimensional flexible abrasive materials have very specific properties:

- Can be used both wet and dry.
- Adapt extremely easily to the workpiece.
- Non-absorbent due to the open web structure.
- Do not contain any iron and are therefore ideal for working, amongst other materials, stainless steel.
- Create a constant and even finish.
- Are forgiving, can also be used by inexperienced users.
- Serve as the basis for a wide variety of derivative products:
 - open and closed grinding belts (p. 122)
 - discs, whether or not laminated on fibre, cloth or velvet (p. 171)
 - quick change discs: Socatt® – Roloc® (p. 305 & p. 311)
 - disc grinding wheels with spindle or centre hole (p. 348)
 - flap grinding wheels with spindle or centre hole (p. 342)



- **Three-dimensional flexible abrasive materials**
 - Specific properties
 - Specific abrasive operations



Did you know that forgiving grinding materials are always compressed materials? They are characterised by low generation of heat, a high machine capacity and a high finish.

➤ SPECIFIC ABRASIVE OPERATIONS

Due to the wide diversity of applications, versions and grit sizes, the three-dimensional abrasive materials can be used successfully for working practically any material you can think of, e.g. stainless steel, aluminium and non-ferrous metal, metal, titanium and cobalt alloys, lacquers, paints, varnishes, wood, stone, plastics, parquet flooring, stone and synthetic floors, etc.

Whether dealing with cleaning, grinding, satinising, structuring, matting, roughing up, brushing, removing down, fluff, remove rust, light deburring, etc, three-dimensional abrasive materials can undertake this easily.



Did you know that the development of new and innovative grinding techniques is very important to Cibo? Cibo turns grinding materials into solution-oriented products. Using, processing or combining materials in a different manner, Cibo has succeeded time and again in launching innovative grinding materials onto the market.



● **Three-dimensional semi-flexible abrasive materials**

→ Convoluted materials

○ Unitized materials

➤ Three-dimensional semi-flexible grinding materials

➤ CONVOLUTED MATERIALS

Convoluted abrasive materials are only produced in wheel form. The convoluted wheels consist of impregnated tex nylon membrane which is glued on to a hard core and convoluted layer by layer into a homogenous wheel with a controlled density.

Properties:

- Soft grinding contact for comfortable working.
- Fixed, even density.
- Entirely free from iron, i.e. ideal for working stainless steel and other materials.
- Adapts to the workpiece in a flexible manner.
- Ideal combination of lifespan, material removal and level of finish.
- Cooler grinding.



Caution! The convolute wheels can only be used in 1 direction. Therefore, you always have to follow the instruction on the disc label.



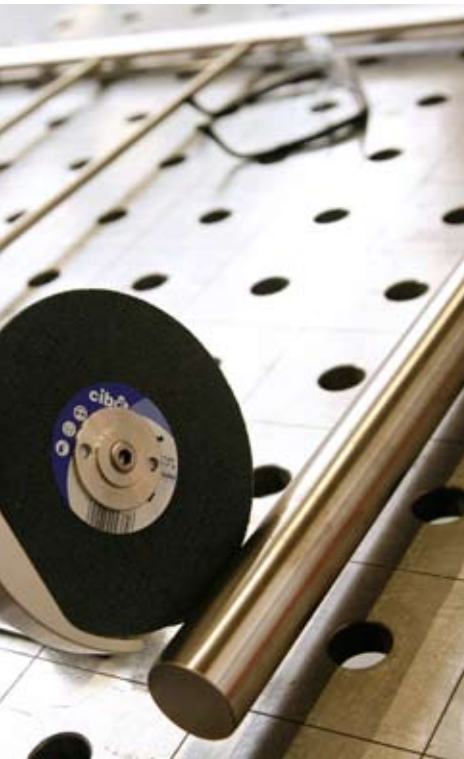

➤ UNITIZED MATERIALS

The range of compressed abrasive materials or unitized material makes up a new generation of abrasive materials. They consist of a three-dimensional web of nylon fibres, permeated with abrasive grit in a synthetic resin, ingeniously bonded together. Under controlled heat and pressure they are pressed into fixed sheets of a controlled density. Subsequently, these sheets are used to produce wheels and discs.

Unitized abrasive materials exist in various thicknesses, sizes and densities and they allow you to finish materials in a simple and consistent manner.

Unitized materials also differ from traditional abrasive materials in combining a surprisingly aggressive action with an excellent finish.

Properties:

- Even and consistent density for a high-quality finish.
- Flexible, capable of adapting to the shape of the workpiece.
- Increased life span.
- Free of iron – inoxsafe.
- Residue-free formula, does not leave any “smearing”
- Cooling prevents burnt surfaces.
- Open web structure prevents caking of grinding dust.
- Little dust development.

● **Three-dimensional semi-flexible abrasive materials**

- Convoluted materials
- Unitized materials

Applications:

- **Remove joint discolouration**
Not only the coloured haze, but also deeper burnt surface areas that appear on the metal due to heat generation during welding, can be easily removed.
- **Angle Angle refraction, deburring and rounding**
- **Remove TIG welds**
- **Correction of grinding errors and removal of scratching**
Scratches from sharp objects on the workpiece or grinding errors caused by the use of too rough or incorrect grinding materials can be removed with the use of unitized material, without modifying the geometry of the workpiece.
- **Removal of milling lines**
It is often still possible to see the track the milling cutter has followed on milled workpieces. In order to finish these surfaces, unitized material can be used.
- **Remove lacquers and coatings**
- **Remove rust**
- **Pre-polishing**
Polishing often requires elaborate preparations. Grinding with unitized material beforehand is an ideal last step for high-gloss polishing which will save you a lot of time and work.
- **Turbine blades, propellers and propeller blades**
- **Improvement of surface roughness**
In the pharmaceutical and food sectors, high demands are placed on the surface roughness of products. With unitized materials, the Ra value of the surface can be managed perfectly.

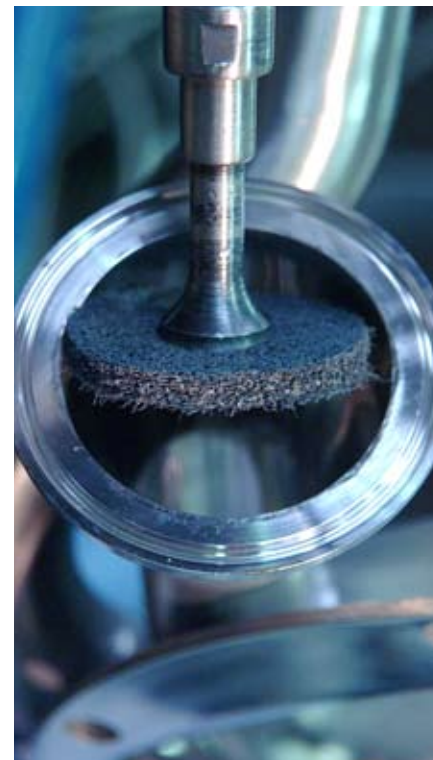
**Speed**

Please consult the product label each time for our recommended speed. Too high speed can lead to excessive heat and premature wear. A correct rotational speed guarantees a maximum yield and better finish.

▣ Grit designation

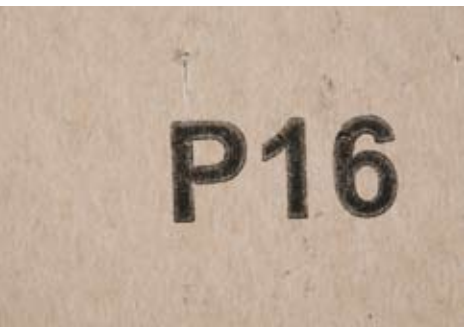

In Europe, the grit size of flexible abrasive material is indicated according to the FEPA standard. FEPA is the European Federation of Manufacturers of Grinding and Cutting Materials. Each grit designation is preceded by the letter "P". In the United States, the ANSI or CAMI standard is generally used. Japan follows the JIS designation. Besides that, there are a number of other designations like the APEX, for structured grit types like the Trizact™; the various designations for the

Micro-Mesh and the Micron designation. In order to obtain a clear picture, please find on the opposite side an overview and comparison of the most frequently used grades. Caution: this conversion table is only a guideline and gives only an indication of approximate values. In the last column, you can read the approximate level of coarseness that can be obtained using a specific grit type.



Did you know that Cibo has one of the most efficient and best equipped manufacturing plants in Europe? Cibo turns the rolls of basic material into solution-oriented products. At our Tildonk branch in Belgium, Cibo produces grinding belts, discs, wheels, flap wheels, Quick-Change discs, etc. Are you looking for a grinding product with very specific properties? Cibo can produce it for you in almost no time.

Trizact™ is a registered trademark of the 3M Company.

- Grit designation
- Conversion chart

➤ CONVERSION CHART

Fepa p	CAMI	Apex (Trizact™, Norax™) or structured abrasives	Mirco-Mesh cushioned abrasives regular	Mirco-Mesh cushioned abrasives mx	JIS (Japan)	Micron	Approximate Ra-values µm *
P80		A-300					
P120	100				J100	125	
	120	A-160					
P150		A-130					
	150						
P180	180				J150	80	
		A-100					1,50-0,80
P220	220	A-90			J180	65	
					J220		
					J240		
P240		A-80			J320	60	
			60			57	
P280							
P320		A-65			J360	52	0,85-0,70
	240						
P360	280		80		J400	45	
	320		100				0,70 - 0,60
P400		A-45	120			42	
					J500	34	
P500					J600	29	0,60 - 0,40
	360		150				
P600		A-35	180				
	400	A-30		180			0,40-0,30
P800			1500		J700	30	
P1000	500				J800	20	
P1200		A-16			J1000	15	
	600		1800	240			0,30-0,25
P1500		A-10	2400	320	J1200	13	
	800						
P2000		A-06				10	0,25-0,20
	1000						
P2500					J2000	9	0,20-0,10
	1200		3200	360			
	1350		3600	400	J3000	8	0,10-0,05
	1500	A-05	4000	600		5	
			6000	800	J4000	4	
		A-03	8000	1200	J6000	3	0,03-0,02
			12000				

* The above Ra values are approximate and were obtained on 304 Stainless Steel with conventional cloth sanding belts, with a contact wheel of 60° Shore and a belt speed of 25 metres / second. When the same grit is used in disk form, a better smoothness value is obtained, and hence lower Ra values.



OVERVIEW TABLE
ABRASIVE MATERIALS AND APPLICATIONS

➤ USE OF THE TABLE

In this chapter we have listed all possible basic abrasive materials. The overview provides the grit type, the backing, the top coating if present, whether the material is waterproof, the grit size range, etc., for each type. At the end of the table, is mentioned for which application the material is suited and in which forms the material is available. Based on the properties discussed, you can then select the material that is best suited for your specific application.

If you know the final form (disc, roll, belt or sheet) you can also consult the relevant chapter.

Are you having difficulty getting a clear picture? Please do not hesitate to contact one of our experts. They will be more than happy to help you choose the best abrasive material for your specific application.

	Type	Backing	Weight	Type of grit	Top Coating	Waterproof	Maximum width	Properties
PAPER	SA331	Film	–	A/O	●	💧	1380	Open coated aluminium oxide grit with an active abrasive ingredient on a film backing. Extremely tear-resistant. Does not clog up, long life span, extremely large grit size range. Can be used for many purposes, especially with more intensive grinding operations. Ideal for finishing of soft wood types and car repair, paints, lacquers and varnishes. Used both wet and dry.
	CA330	Paper	C	A/O	●	–	1380	Open coated aluminium oxide with grinding aid on flexible “C” paper. Very pliable and flexible, does not clog, adapts easily to the workpiece and guarantees a beautiful, even finish. Ideal for grinding primary coats, primers, sealers, lacquers, paint, varnish, filler and wood.
	KP915C	Paper	C	A/O	–	💧	ONLY IN SHEET FORM	High-quality and very flexible, waterproof sandpaper with aluminium oxide grit. The base consists of a flexible, easily pliable paper latex base with “C” weight. For use in the auto industry and, primarily with wet intermediate grinding of paints, lacquers and varnishes.
	KP905E	Paper	E	A/O	–	–	1450	Antistatic, aluminium oxide on a strong “E” backing. Specially developed with a heavier, less tear-resistant backing for heavier, manual work and for applications on light manual grinding machines.
	KP947F	Paper	F	A/O	–	–	1450	Antistatic, close coated aluminium oxide on a very strong “F” paper base. The antistatic property ensures the easy removal of dust. The KP947F is a product that can be used for various purposes. Perfect grade for both dry and hard woods as well as for those of a softer quality with a higher level of resin.

GRIT DESIGNATION

For most of the materials mentioned in the table, the range of grit size is given in the FEPA-indication (P). Only a different grit is used with Micro-Mesh and Trizact™, preceded by a letter code (see conversion table p. 55). For the textured and reinforced textured materials, no FEPA-grit indication is used. A letter indicator is used for the grit size of textured and reinforced textured.

Grit range (P)	APPLICATIONS											FORMS					
	Metal	Stainless steel	High-quality alloys	Non-ferrous	Aluminium	Hard wood	Soft wood	Glass/Stone	Plastics / Rubber	Car repair	Lacquers / Varnishes	Leather	Rolls	Belts	Discs	Sheets	Grip
Grip: 40-60-80-100-120-150-180-220-320-400-600-800-1200 Without grip: 80-120-320-400	○	○		○	○	○	●			●	●	●					●
Grip: 60-80-100-120-150-180-220-240-320-400-500-600 Without grip: 60-80-100-120-150-180-220-320-400-500-600	○			○	○	○	●			●	●	●					●
Grip: 600-800-1000-1200 Without grip: 60-80-100-120-150-180-220-240-280-320-360-400-500-600-800-1000-1200				○	○		○			●	●					●	●
40-60-80-100-120-150-180-220	○			○	○	●	●			○		○	●			●	
240-280-320-400	○	○		○	○	●	●			○		○	●	●	●	●	●

● = recommended application ○ = possible application

	Type	Backing	Weight	Type of grit	Top Coating	Waterproof	Maximum width	Properties
PAPER	KP949FO	Paper	F	A/O	–	–	1450	Antistatic, semi-open coated aluminium oxide on a very strong “F” paper base. The antistatic property ensures the easy removal of dust. The KP949FO is a product that can be used for various purposes. Perfect grade for both dry and hard woods as well as for those of a softer quality with a higher level of resin.
	KP950F	Paper	F	ZIRC.	–	–	1450	Zirconium oxide grain on an “F” paper base. This product is ideally suited for grinding hard and dry wood types due to the extremely abrasion-resistant zirconium oxide grit. The KP950F is also highly efficient when using stainless steel.
	SP717C	Paper	C	S/C	–	💧	ONLY IN SHEET FORM	High-quality and very flexible waterproof sandpaper with a silicon carbide grit type. The base consists of a flexible, easily pliable latex backing with “C” weight. Primarily for applications in the auto industry and auto repair shops.
	SP705EO	Paper	E	S/C	●	–	1450	Antistatic silicon carbide grit on a “E” paper with the addition of zinc stearate. This paper is ideally suited for finishing. The addition of stearate ensures that the grinding process is cool and that the grit does not become saturated. Ideal for the intermediate grinding of primers, sealers, paints, varnishes, polyester and polyurethane lacquers, etc.
	SP706F	Paper	F	S/C	–	–	1450	Antistatic silicon carbide grit on a very strong “F” base. Ideally suited for use in sanding wooden floors and parquet.
	LKE22	Combination	–	S/C	–	–	1250	Combination abrasive material. A heavy F paper reinforced with a light fabric and provided with a very open silicon carbide grit structure. Primarily for use in sanding old and dirty wooden floors and parquet. Also suitable for removing old paint, glue and varnish layers or carpet remains.
CLOTH	TF41	Cotton	F	A/O	–	–	1420	Very flexible abrasive cloth, for manual use in metal working. Also a perfect partner for grinding hard wood types.
	TF50	Cotton	F	A/O	–	–	1420	High-quality, very flexible abrasive cloth for general manual use in metal working. Also a perfect partner for grinding hard wood types.

Grit range (P)	APPLICATIONS											FORMS					
	Metal	Stainless steel	High-quality alloys	Non-ferrous	Aluminium	Hard wood	Soft wood	Glass/Stone	Plastics / Rubber	Car repair	Lacquers/Varnishes	Leather	Rolls	Belts	Discs	Sheets	Grip
Grip: 40-60-80-100-120-150-180-220 Without grip: 36-40-50-60-80-100-120-150-180-220	○	○	○	○	○	●	●			○	○	○	●	●	●	●	●
40-60-80-100-120-150-180-220	○	●	○	○	○	●	○			○		○	●	●	●	●	●
60-80-100-120-150-180-220-240-280-320-360-400-500-600-800-1000-1200-1500-2000-2500	○		○	●				●	●	●	●					●	
220-240-280-320-400-500-600-800					○	○	○		○		●	○	●	●			
Grip: 24-36-40-60-80-100-120-220-320-400-500-600-800-1000-1200 Without grip: 24-36-40-50-60-80-100-120-150-180-220-240-280-320-400-500-600-800-1000-1200					○	●	●	●					●	●	●	●	●
16-20						●	●		○		○			●	●	●	●
36-40-50-60-80-100-120-150-180-220-240-280-320	●	●	●	●	●	●	○		○		○		●			●	
40-60-80-100-120-150-180-220-240-280-320-400-500-800	●	●	●	●	●	●	○		○		○		●			●	

● = recommended application ○ = possible application

	Type	Backing	Weight	Type of grit	Top Coating	Waterproof	Maximum width	Properties
CLOTH	BTX22	Cotton	X	A/O	–	–	1240	Aluminium oxide on an “X” cotton base. The quality is good for universal applications, with a very good price-performance ratio.
	TX52	Cotton	X	A/O	–	–	1420	A heavy “X” type of cloth abrasive with high-quality aluminium oxide. Ideal for use on all types of steel and cast iron. Also suitable for grinding hard and dry woods at medium to high pressure.
	TJ7	Polyester-cotton	J	A/O	–	–	1420	Aluminium oxide on a flexible J-flex polyester cotton backing. Suitable for general use, for work on either metal or wood, where flexibility is important.
	JF4T	Polyester-cotton	J/F	A/O	●	–	1420	High-quality aluminium oxide on a very flexible base with grinding aids. A technically innovative product with exceptional properties. Cool grinding process without discolouration. Ideally suited for high-quality finishing of medical implants, surgical instruments, knives, turbine blades, etc. Ideal quality for creating a consistent and equal finish on stainless steel. Its flexible base allows the JF4T to adapt easily to the shape of the workpiece.
	HA66	Polyester	H	A/O	–	💧	1420	High-quality aluminium oxide on “H” polyester backing. Can be applied to either a dry or wet surface. Mainly for use on all types of iron and steel. Suitable for heavier applications due to the tear-resistant polyester backing.
	PG730	Polyester	H	A/O Compact	–	💧	1380	Aluminium oxide compact grit on a polyester backing. At the onset, this compact grit has a slightly lower stock removal capacity, but it more than makes up for this by its extremely long life span (3 to 5 times longer is no exception). The PG730 can operate under heavy working pressure, both wet and dry.
	TZ59	Cotton	X	ZIRC.	–	–	1420	High-quality aluminium/zirconium oxide on a highly resistant “X” backing. Ideal for professional applications on stainless steel, aluminium, metal, non-ferrous metals and hard wood.
	HZ72	Polyester	Y	ZIRC.	–	💧	1420	High-quality aluminium/zirconium oxide op on a heavy “Y” polyester backing. Ideal for demanding applications on stainless steel, aluminium, metal and non-ferrous metal. Very good and quick stock removal. Can be used both wet and dry.
HZ8T	Polyester	Y/H	ZIRC.	●	💧	1420	100% zirconium oxide grit on a heavy “Y” polyester backing with grinding aids. The pure zirconium oxide ensures an extremely fast grinding process, while the active abrasive ingredient guarantees a very cool grinding process. This top product is ideal for heavy and fast stock removal of primarily stainless steel and very hard types of steel.	

	Grit range (P)	APPLICATIONS											FORMS								
		Metal	Stainless steel	High-quality alloys	Non-ferrous	Aluminium	Hard wood	Soft wood	Glass/Stone	Plastics/Rubber	Car repair	Lacquers/Varnishes	Leather	Rolls	Belts	Discs	Sheets	Grip			
	16-24-36-40-50-60-80-100-120-150-180-240	○			○	○	●	●					○	○				●			
	16-24-36-40-50-60-80-100-120-150-180-220	●	○	○	○	○	●	○							○				●		
	60-80-100-120-150-180-220-240-320-400	●	○	○	○	○	●	○							○				●		
	J (60-80-100-120); F (150-180-220-320-400)	●	●	●	●	●													●		
	80-100-120-150-180-220-240-320-400-500	●	○	○	○	○	○	○							○				●		
	80-120-240-320-400-600	●	○	○															●		
	36-40-50-60-80-100-120	●	●		●	●	●	○											●	●	●
	24-36-40-50-60-80	●	●	○	●	●	○												●		
	36-40-50-60-80	●	●	●	○	○													●		

● = recommended application ○ = possible application

	Type	Backing	Weight	Type of grit	Top Coating	Waterproof	Maximum width	Properties
CLOTH	HG49T	Polyester	Y	CER.	●	💧	1420	A high-quality ceramic grinding grit on a heavy "Y" tear-resistant polyester backing with grinding aids. This absolute top of the range product has a very high stock removal capacity on hard and highly alloyed steel types. Operates extremely well under high operating pressure on a hard to very hard grinding contact.
	777F	Polyester	H	CER.	●	💧	1320	Ceramic grit with added grinding aids on a stable polyester backing. Can be used both wet and dry. Ideal product for medium-heavy applications.
	WC44	Cotton	X/W	S/C	–	💧	1420	Silicon carbide on a waterproof "X" cotton backing. Suited for working glass and stone, both dry and wet. Can also be used to work non-ferrous metals, plastics, polyesters and rubber.
	CJ83	Polyester-cotton	J	S/C	–	–	1420	Silicon carbide on a flexible polyester cotton base. Ideal for working on aluminium, high quality alloys, polyesters and plastics.
	CJ91	Polyester cotton	J	S/C	–	–	1420	Silicon carbide on a flexible polyester cotton base. Ideal for working on non-ferrous metals, aluminium, high-quality alloys, porcelain, polyesters and plastics.
	HC25	Polyester	H	S/C	–	💧	1420	Silicon carbide on a waterproof "H" polyester backing. Suited for working glass and stone, both dry and wet. Can also be used to work non-ferrous metals, aluminium, plastics, polyesters and rubber.
	QNSH	Mesh	–	S/C	–	💧	910	Open polyester web structure to which grit is anchored on both sides.
	237AA	Cotton	X	A/O Trizact™	–	–	660	This is a product of the Trizact™ family (3M). Trizact™ is an innovative grinding material produced with perfectly calibrated aluminium oxide grit in a pyramid shape. This three-dimensional grit of identical height ensure quick stock removal and an even and replicable finish without deep scratching or risk of burrs. This product has been especially developed for material that is difficult to work, such as stainless steel and exotic alloys, as used in aviation and space travel and in the medical sector. In addition, it has been used successfully in the finishing of copper, bronze, aluminium, composite materials and synthetic materials. The 237AA is not suited for use on titanium.
	337DC	Cotton	X	A/O Trizact™	–	–	660	The properties of the 337DC Trizact™ grade are similar to those of the 237AA, but the 337DC has a higher stock removal capacity.













	Grit range (P)	APPLICATIONS											FORMS					
		Metal	Stainless steel	High-quality alloys	Non-ferrous	Aluminium	Hard wood	Soft wood	Glass/Stone	Plastics/ Rubber	Car repair	Lacquers/Varnishes	Leather	Rolls	Belts	Discs	Sheets	Grip
	36-40-50-60-80	●	●	●	○	○									●	●		
	40-60-80-100-120	○	●	●	●	○									●	●		●
	280-320-400	○	○	○	●	○			●	●					●			
	80-100-120-150-180		○	●	○	●			○	●					●			
	240-320	○	○	●	●	●			○	●					●			
	24-36-40-60-80-100-120-150-180-220	○	○	○	●	●			●	●					●			
	40-60-80-100-120-150-180-220-320-400-600						○	●		○	●			●		●	●	
	A160 (P120)-A100 (P220)-A80 (P240)-A65 (P280)-A45 (P400)-A30 (P600)-A16 (P1400)-A6 (P2000)	○	●	●	●	●									●	●		●
	A300 (P80)-A160 (P120)-A100 (P220)-A65 (P280)-A45 (P400)	○	●	●	●	●									●	●		●

● = recommended application ○ = possible application







	Type	Backing	Weight	Type of grit	Top Coating	Waterproof	Maximum width	Properties
CLOTH	953FA	Polyester	H	CER. Trizact™	–	💧	660	This Trizact™ grade is made from a calibrated cubitron grit type on a polyester backing. This quality offers a much higher stock removal capacity than the 337DC and can also be used when wet.
	MFR	Cotton	F	Calibrated A/O	–	💧*	500	Micro-Mesh is a concept whereby extremely precisely calibrated grit crystals are bonded with a flexible glue on a supple cotton base. Due to the elastic positioning, this grit always comes in contact with the workpiece at a positive angle. This ensures a constant and even scratch depth. This ingeniously thought out design guarantees an extremely even, constant and precise finishing pattern.
	MFJ	Cotton	J	Calibrated A/O	–	💧*	500	Micro-Mesh is a concept whereby extremely precisely calibrated grit crystals are bonded with a flexible glue on a supple cotton base. Due to the elastic positioning, this grit always comes in contact with the workpiece at a positive angle. This ensures a constant and even scratch depth. This ingeniously thought out design guarantees an extremely even, constant and precise finishing pattern.
	W445	Polyester	Y	CORK	–	💧	1320	Cork on a polyester backing. Specially designed for working glass borders. After water is added, a better finish is achieved and the life span of the belt is extended.
TEX	A/O	Nylon web	–	A/O	–	💧	1500	The nylon fibres are combined into a three-dimensional web structure using thermo-setting synthetic resin, and are available in various grit types with an aluminium oxide grit. The result is an elastic abrasive material with an open structure that is easy to use and provides an even and constant finish. The tex material does not affect the geometrical shape of the work pieces. A/O creates a good long-lasting finish at high speeds.
	S/C	Nylon web	–	S/C	–	💧	1500	The nylon fibres are combined into a three-dimensional web structure using thermo-setting synthetic resin, and are available in various grit sizes with silicon carbide grit. The result is an elastic abrasive material with an open structure that is easy to use and provides an even and constant finish. The tex material does not affect the geometrical shape of the work pieces. In comparison with the A/O, S/C provides a finer, more even and matt texture. Primarily used to create a decorative finish.

Trizact™ is a registered trademark of the 3M Company.

(*) Micro-mesh achieves the best results provided a light mist is used.
The use of an excessive amount of water is not recommended with Micro-mesh.

Grit range (P)	APPLICATIONS												FORMS				
	 Metal	 Stainless steel	 High-quality alloys	 Non-ferrous	 Aluminium	 Hard wood	 Soft wood	 Glass/Stone	 Plastics/Rubber	 Car repair	 Lacquers/Varnishes	 Leather	Rolls	Belts	Discs	Sheets	Grip
A300 (P80)-A160 (P120)-A100 (P220)-A65 (P280)-A45 (P400)	○	●	●	○	○									●			
MFR1500 (P600)-MFR1800 (P1200)-MFR2400 (P1500)-MFR3200 (P2500)-MFR3600 (P3000)-MFR4000 (P4000)-MFR6000 (P5000)-MFR8000 (P6000)-MFR12000 (P8000)		●	●	○	○	○		○	●	○			●		●	●	●
MFx180 (P600)-MFx240 (P1200)-MFx320 (P1500)-MFx400 (P3000)-MFx600 (P3500)-MFx800 (P4000)-MFx1200 (P6000)		●	●	○	○	○		○	●	○			●	●	●	●	●
–								●					●				
A-Coarse - A-Medium - A-Fine - A-Very Fine STRONG - A-Very Fine SOFT - A-Very Fine SUPERSOFT	●	●	○	○	○	●	●	○	○	●	●	○	●		●	●	●
S-Medium - S-Fine - S-Very Fine - S-Ultra Fine 600 - S-Ultra Fine 1000 - S-Ultra Fine 1200	○	●	●	●	●	○	○	○	●	●	●	○	●		●	●	●

● = recommended application ○ = possible application

	Type	Backing	Weight	Type of grit	Top Coating	Waterproof	Maximum width	Properties
TEX	CP	Nylon web	–	A/O CP	–		610	The nylon fibres are combined into a three-dimensional web structure using thermo-setting synthetic resin with an aluminium oxide grit type. The result is an elastic abrasive material with an open structure that is easy to use and provides an even and constant finish. The tex material does not affect the geometrical shape of the work pieces. CP has an increased grinding capacity at higher speeds. This material provides the brush structure with a slightly glossy effect.
	GP	Nylon web	–	A/S	–		1500	The nylon fibres are combined into a three-dimensional web structure using thermo-setting synthetic resin with an alumino silicate grit type. The result is an elastic abrasive material with an open structure that is easy to use and provides an even and constant finish. The tex material does not affect the geometrical shape of the work pieces. GP is an economical product that is generally used for cleaning.
	00	Nylon web	–	Talc	–		1500	With the TEX 00, the nylon fibres are combined into a three-dimensional web structure using thermo-setting synthetic resin without abrasive grit. This material does not scratch and is ideally suited for cleaning.
	CSD	Nylon web	–	S/C	–		610	CSD material is made from very hard, abrasion-resistant nylon fibres with a very open structure. The nylon fibres are permeated with synthetic resin and very sharp grit.
reinforced TEX	FE	Polyester + Nylon web	–	A/O	–		1250	This is an open nylon web structure, permeated with aluminium oxide grit and anchored by a synthetic resin on a woven polyester structure. This quality is better able to cope with aggressive applications and has a long life span. The finish of the FE quality is less uniform than that of the RC quality.
	RC		–	A/O	–		1250	This is an open nylon web structure, permeated with aluminium oxide grit and anchored by a synthetic resin on a woven polyester structure. This material has a high initial cutting force, works perfectly at low pressure and provides a very constant and even finish. The RC is less edge resistant. Ideal for applications requiring a decorative finish.
	T00		–	–	–		1270	This is an open nylon web structure, permeated with talc and anchored with a synthetic resin on a woven polyester structure. This quality has no abrasive properties and is specially designed to clean or polish using polishing pastes.

Grit range (P)	APPLICATIONS													FORMS				
	Metal	Stainless steel	High-quality alloys	Non-ferrous	Aluminium	Hard wood	Soft wood	Glass/Stone	Plastics/Rubber	Car repair	Lacquers/Varnishes	Leather	Rolls	Belts	Discs	Sheets	Grip	
CP	●	●	○	○	○	○	○		○	○	○	○	●		●	●	●	
GP	○	○	○	○	○	○	○		○	○	○	○	●		●	●		
No grit	○	○	○	○	○	○	○	●	○	●	●	○	●		●	●		
EXTRA COARSE	●	●	○	○	○				●	●	○				●			
COARSE - MEDIUM - VERY FINE	○	●	○	●	●					●				●	●		●	
COARSE - MEDIUM - VERY FINE	○	●	○	●	●									●	●		●	
No grit	○	●	○	●	●									●	●		●	

● = recommended application ○ = possible application

BELTS

● Overview table	72
● Paper	86
○ Aluminium oxide	86
○ Zirconium oxide	88
○ Silicon carbide	88
● Cloth	90
○ Aluminium oxide	90
○ Zirconium oxide	106
○ Ceramic	112
○ Silicon carbide	115
○ Trizact™	117
○ Micro-Mesh	119
○ Cork	120
● Tex	122
○ Aluminium oxide	122
○ Silicon carbide	123
● Surface conditioning	124
○ Aluminium oxide	124
○ No grit	127



Cibo will very quickly produce for you any size, grade or grit that is not listed in the overview.

After all, customisation is the norm at Cibo.

BELTS



➤ OVERVIEW

Thousands of endless belts are produced in the Cibo manufacturing department, in widths ranging from 3mm to 2200mm. As Cibo can manufacture any grade and length, a handy overview is provided at the start of this chapter with the available grades and their properties.

Application		Type	Backing	Weight	Type of grit	Top Coating	Waterproof	Maximum width	Grit type
Metal 	Cloth	TX52	Cotton	X	A/O	–	–	1420	16-24-36-40-50-60-80-100-120-150-180-220
		TJ7	Polyester-cotton	J	A/O	–	–	1420	60-80-100-120-150-180-220-240-320-400
		JF4T	Polyester-cotton	J/F	A/O	●	–	1420	J (60-80-100-120); F (150-180-220-320-400)
		HA66	Polyester	H	A/O	–	💧	1420	80-100-120-150-180-220-240-320-400-500
		PG730	Polyester	H	A/O Compact	–	💧	1380	80-120-240-320-400-600
		TZ59	Cotton	X	ZIRC.	–	–	1420	36-40-50-60-80-100-120
		HZ72	Polyester	Y	ZIRC.	–	💧	1420	24-36-40-50-60-80
		HZ8T	Polyester	Y/H	ZIRC.	●	💧	1420	36-40-50-60-80
		HG49T	Polyester	Y	CER.	●	💧	1420	36-40-50-60-80

USE OF THE TABLE

Simply look at the material you want to work on, select one of the grades recommended by Cibo and you will be referred to the page where you can find the belt you require. The referral page contains the all the most prevalent grit types and sizes.

However, customisation is also the norm at Cibo. Please do not hesitate to contact Cibo if you require a size that is not listed in the table. We can produce the belts for you in almost no time. We automatically adjust the weld joints of the belts to the grit and the base of the material, and if this is known, also to the application the belt will be used for (see page 41).

Take note: this table only shows the qualities that Cibo feels are the most suitable for a specific application. Should you require a broader overview, please return to the comprehensive overview of the available basic materials on page 58.















Properties	Page
A heavy "X" type of cloth abrasive with high-quality aluminium oxide. Ideal for use on all types of steel and cast iron. Also suitable for grinding hard and dry woods at medium to high pressure.	99
Aluminium oxide on a flexible J-flex polyester cotton backing. Suitable for general use, for work on either metal or wood, where flexibility is important.	104
High-quality aluminium oxide on a very flexible base with grinding aids. A technically innovative product with exceptional properties. Cool grinding process without discolouration. Ideally suited for high-quality finishing of medical implants, surgical instruments, knives, turbine blades, etc. Ideal quality for creating a consistent and equal finish on stainless steel. Its flexible base allows the JF4T to adapt easily to the shape of the workpiece.	104
High-quality aluminium oxide on "H" polyester backing. Can be applied to either a dry or wet surface. Mainly for use on all types of iron and steel. Suitable for heavier applications due to the tear-resistant polyester backing.	105
Aluminium oxide compact grit on a polyester backing. At the onset, this compact grit has a slightly lower speed of cut, but it more than makes up for this by its extremely long life span (3 to 5 times longer is no exception). The PG730 can operate under heavy working pressure, both wet and dry.	105
High-quality aluminium/zirconium oxide on a highly resistant "X" backing. Ideal for professional applications on stainless steel, aluminium, metal, non-ferrous metals and hard wood.	106
High-quality aluminium/zirconium oxide on a heavy "Y" polyester backing. Ideal for demanding applications on stainless steel, aluminium, metal and non-ferrous metal. High cut rate. Can be used both wet and dry.	110
100% zirconium oxide grit on a heavy "Y" polyester backing with grinding aids. The pure zirconium oxide ensures an extremely fast grinding process, whilst the active abrasive ingredient guarantees a very cool grinding process. This top product is ideal for heavy and fast grinding of primarily stainless steel and very hard types of steel.	111
A high-quality ceramic grinding grit on a heavy "Y" tear-resistant polyester backing with grinding aids. This absolute top of the range product has a very high stock removal capacity on hard and highly alloyed steel types. Operates extremely well under high operating pressure on a hard to very hard grinding contact.	112

Application		Type	Backing	Weight	Type of grit	Top Coating	Waterproof	Maximum width	Grit type
Stainless steel 	Paper	KP950F	Paper	F	ZIRC.	–	–	1450	40-60-80-100-120-150-180-220
	Cloth	JF4T	Polyester-cotton	J/F	A/O	●	–	1420	J (60-80-100-120); F (150-180-220-320-400)
		TZ59	Cotton	X	ZIRC.	–	–	1420	36-40-50-60-80-100-120
		HZ72	Polyester	Y	ZIRC.	–	💧	1420	24-36-40-50-60-80
		HZ8T	Polyester	Y/H	ZIRC.	●	💧	1420	36-40-50-60-80
		HG49T	Polyester	Y	CER.	●	💧	1420	36-40-50-60-80
		777F	Polyester	H	CER.	●	💧	1320	40-60-80-100-120
		237AA	Cotton	X	A/O Trizact™	–	–	660	A160 (P120)-A100 (P220)-A80 (P240)-A65 (P280)-A45 (P400)-A30 (P600)-A16 (P1400)-A6 (P2000)
		337DC	Cotton	X	A/O Trizact™	–	–	660	A300 (P80)-A160 (P120)-A100 (P220)-A65 (P280)-A45 (P400)
		953FA	Polyester	H	CER. Trizact™	–	💧	660	A300 (P80)-A160 (P120)-A100 (P220)-A65 (P280)-A45 (P400)
		MFX	Cotton	J	Calibrated A/O	–	💧*	500	MFX180 (P600)-MFX240 (P1200)-MFX320 (P1500)-MFX400 (P3000)-MFX600 (P3500)-MFX800 (P4000)-MFX1200 (P6000)

Trizact™ is a registered trademark of the 3M Company.

(*) Micro-mesh achieves the best results provided a light mist is used. The use of an excessive amount of water is not recommended with Micro-mesh.

Properties	Page
Zirconium oxide grain on an "F" paper base. This product is ideally suited for grinding very hard and dry woods because of the extremely abrasive-resistant zirconium oxide grit. The KP950F is also highly efficient when using stainless steel.	88
High-quality aluminium oxide on a very flexible base with grinding aids. A technically innovative product with exceptional properties. Cool grinding process without discolouration. Ideally suited for high-quality finishing of medical implants, surgical instruments, knives, turbine blades, etc. Ideal quality for creating a consistent and equal finish on stainless steel. Its flexible base allows the JF4T to adapt easily to the shape of the workpiece.	104
High-quality aluminium/zirconium oxide on a highly resistant "X" backing. Ideal for professional applications on stainless steel, aluminium, metal, non-ferrous metals and hard wood.	106
High-quality aluminium/zirconium oxide on a heavy "Y" polyester backing. Ideal for demanding applications on stainless steel, aluminium, metal and non-ferrous metal. High cut rate. Can be used both wet and dry.	110
100% zirconium oxide grit on a heavy "Y" polyester backing with grinding aids. The pure zirconium oxide ensures an extremely fast grinding process, whilst the active abrasive ingredient guarantees a very cool grinding process. This top product is ideal for heavy and fast grinding of primarily stainless steel and very hard types of steel.	111
A high-quality ceramic grinding grit on a heavy "Y" tear-resistant polyester backing with grinding aids. This absolute top of the range product has a very high stock removal capacity on hard and highly alloyed steel types. Operates extremely well under high operating pressure on a hard to very hard grinding contact.	112
Ceramic grit with added grinding aids on a stable polyester backing. Can be used both wet and dry. Ideal product for medium-heavy applications.	115
This is a product of the Trizact™ family (3M). Trizact™ is an innovative grinding material produced with perfectly calibrated aluminium oxide grit in a pyramid shape. This three-dimensional grit of identical height ensure quick stock removal and an even and replicable finish without deep scratching or risk of burrs. This product has been especially developed for material that is difficult to work, such as stainless steel and exotic alloys, as used in aviation and space travel and in the medical sector. In addition, it has been used successfully in the finishing of copper, bronze, aluminium, composite materials and synthetic materials. The 237AA is not suited for use on titanium.	117
The properties of the quality of the 337DC Trizact™ are similar to those of the 237AA, but the 337DC has a higher stock removal capacity.	118
This Trizact™ grade is made from a calibrated cubitron grit type on a polyester backing. This quality offers a much higher stock removal capacity than the 337DC and can also be used when wet.	118
Micro-Mesh is a concept whereby extremely precisely calibrated grit crystals are bonded with a flexible glue on a supple cotton base. Due to the elastic positioning, this grit always comes in contact with the workpiece at a positive angle. This ensures a constant and even scratch depth. This ingeniously thought out design guarantees an extremely even, constant and precise finishing pattern.	119

Application		Type	Backing	Weight	Type of grit	Top Coating	Waterproof	Maximum width	Grit type
Stainless steel 	Reinforced Tex	FE	Polyester + Nylon web	–	A/O	–		1250	COARSE - MEDIUM - VERY FINE
		RC		–	A/O	–		1250	COARSE - MEDIUM - VERY FINE
		T00		–	–	–		1270	No grit
High-quality alloys 	Cloth	JF4T	Polyester-cotton	J/F	A/O		–	1420	J (60-80-100-120); F (150-180-220-320-400)
		HZ8T	Polyester	Y/H	ZIRC.			1420	36-40-50-60-80
		HG49T	Polyester	Y	CER.			1420	36-40-50-60-80
		777F	Polyester	H	CER.			1320	40-60-80-100-120
		CJ83	Polyester-cotton	J	S/C	–	–	1420	80-100-120-150-180
		CJ91	Polyester-cotton	J	S/C	–	–	1420	240-320
		237AA	Cotton	X	A/O Trizact™	–	–	660	A160 (P120)-A100 (P220)-A80 (P240)-A65 (P280)-A45 (P400)-A30 (A600)-A16 (P1400)-A6 (P2000)
		337DC	Cotton	X	A/O Trizact™	–	–	660	A300 (P80)-A160 (P120)-A100 (P220)-A65 (P280)-A45 (P400)
		953FA	Polyester	H	CER. Trizact™	–		660	A300 (P80)-A160 (P120)-A100 (P220)-A65 (P280)-A45 (P400)
		MFX	Cotton	J	Calibrated A/O	–		*	500

Trizact™ is a registered trademark of the 3M Company.

(*) Micro-mesh achieves the best results provided a light mist is used. The use of an excessive amount of water is not recommended with Micro-mesh.

Properties	Page
This is an open nylon web structure, permeated with aluminium oxide grit and anchored by a synthetic resin on a woven polyester structure. This quality is better able to cope with aggressive applications and has a long life span. The finish of the FE quality is less uniform than that of the RC quality.	124
This is an open nylon web structure, permeated with aluminium oxide grit and anchored by a synthetic resin on a woven polyester structure. This material has a high initial cutting force, works very well at low pressure and provides a very constant, even finish. The RC is less edge resistant. Ideal for applications requiring a decorative finish.	127
This is an open nylon web structure, permeated with talc and anchored with a synthetic resin on a woven polyester structure. This quality has no abrasive properties and is specially designed to clean or polish using polishing pastes.	127
High-quality aluminium oxide on a very flexible base with grinding aids. A technically innovative product with exceptional properties. Cool grinding process without discolouration. Ideally suited for high-quality finishing of medical implants, surgical instruments, knives, turbine blades, etc. Ideal quality for creating a consistent and equal finish on stainless steel. Its flexible base allows the JF4T to adapt easily to the shape of the workpiece.	104
100% zirconium oxide grit on a heavy "Y" polyester backing with grinding aids. The pure zirconium oxide ensures an extremely fast grinding process, whilst the active abrasive ingredient guarantees a very cool grinding process. This top product is ideal for heavy and fast grinding of primarily stainless steel and very hard types of steel.	111
A high-quality ceramic grinding grit on a heavy "Y" tear-resistant polyester backing with grinding aids. This absolute top of the range product has a very high stock removal capacity on hard and highly alloyed steel types. Operates extremely well under high operating pressure on a hard to very hard grinding contact.	112
Ceramic grit with added grinding aids on a stable polyester backing. Can be used both wet and dry. Ideal product for medium-heavy applications.	115
Silicon carbide on a flexible polyester cotton base. Ideal for working on aluminium, high quality alloys, polyesters and plastics.	115
Silicon carbide on a flexible polyester cotton base. Ideal for working on non-ferrous metals, aluminium, high-quality alloys, porcelain, polyesters and plastics.	116
This is a product of the Trizact™ family (3M). Trizact™ is an innovative grinding material produced with perfectly calibrated aluminium oxide grit in a pyramid shape. This three-dimensional grit of identical height ensure quick stock removal and an even and replicable finish without deep scratching or risk of burrs. This product has been especially developed for material that is difficult to work, such as stainless steel and exotic alloys, as used in aviation and space travel and in the medical sector. In addition, it has been used successfully in the finishing of copper, bronze, aluminium, composite materials and synthetic materials. The 237AA is not suited for use on titanium.	117
The properties of the quality of the 337DC Trizact™ are similar to those of the 237AA, but the 337DC has a higher stock removal capacity.	118
This Trizact™ grade is made from a calibrated cubitron grit type on a polyester backing. This quality offers a much higher stock removal capacity than the 337DC and can also be used when wet.	118
Micro-Mesh is a concept whereby extremely precisely calibrated grit crystals are bonded with a flexible glue on a supple cotton base. Due to the elastic positioning, this grit always comes in contact with the workpiece at a positive angle. This ensures a constant and even scratch depth. This ingeniously thought out design guarantees an extremely even, constant and precise finishing pattern.	119

Application		Type	Backing	Weight	Type of grit	Top Coating	Waterproof	Maximum width	Grit type	
Non-ferrous 	Cloth	JF4T	Polyester-cotton	J/F	A/O	●	–	1420	J (60-80-100-120); F (150-180-220-320-400)	
		TZ59	Cotton	X	ZIRC.	–	–	1420	36-40-50-60-80-100-120	
		HZ72	Polyester	Y	ZIRC.	–	●	1420	24-36-40-50-60-80	
		777F	Polyester	H	CER.	●	●	1320	40-60-80-100-120	
		WC44	Cotton	X/W	S/C	–	●	1420	280-320-400	
		CJ91	Polyester-cotton	J	S/C	–	–	1420	240-320	
		HC25	Polyester	H	S/C	–	●	1420	24-36-40-60-80-100-120-150-180-220	
		237AA	Cotton	X	A/O Trizact™	–	–	660	A160 (P120)-A100 (P220)-A80 (P240)-A65 (P280)-A45 (P400)-A30 (P600)-A16 (P1400)-A6 (P2000)	
		337DC	Cotton	X	A/O Trizact™	–	–	660	A300 (P80)-A160 (P120)-A100 (P220)-A65 (P280)-A45 (P400)	
	Reinforced Tex	FE			–	A/O	–	●	1250	COARSE - MEDIUM - VERY FINE
		RC	Polyester + Nylon web		–	A/O	–	●	1250	COARSE - MEDIUM - VERY FINE
T00				–	–	–	●	1270	No grit	



Trizact™ is a registered trademark of the 3M Company.

Properties	Page
High-quality aluminium oxide on a very flexible base with grinding aids. A technically innovative product with exceptional properties. Cool grinding process without discolouration. Ideally suited for high-quality finishing of medical implants, surgical instruments, knives, turbine blades, etc. Ideal quality for creating a consistent and equal finish on stainless steel. Its flexible base allows the JF4T to adapt easily to the shape of the workpiece.	104
High-quality aluminium/zirconium oxide on a highly resistant "X" backing. Ideal for professional applications on stainless steel, aluminium, metal, non-ferrous metals and hard wood.	106
High-quality aluminium/zirconium oxide on a heavy "Y" polyester backing. Ideal for demanding applications on stainless steel, aluminium, metal and non-ferrous metal. High cut rate. Can be used both wet and dry.	110
Ceramic grit with added grinding aids on a stable polyester backing. Can be used both wet and dry. Ideal product for medium-heavy applications.	115
Silicon carbide on a waterproof "X" cotton backing. Suited for working glass and stone, both dry and wet. Can also be used to work non-ferrous metals, plastics, polyesters and rubber.	115
Silicon carbide on a flexible polyester cotton base. Ideal for working on non-ferrous metals, aluminium, high-quality alloys, porcelain, polyesters and plastics.	116
Silicon carbide on a waterproof "H" polyester backing. Suited for working glass and stone, both dry and wet. Can also be used to work non-ferrous metals, aluminium, plastics, polyesters and rubber.	116
This is a product of the Trizact™ family (3M). Trizact™ is an innovative grinding material produced with perfectly calibrated aluminium oxide grit in a pyramid shape. This three-dimensional grit of identical height ensure quick stock removal and an even and replicable finish without deep scratching or risk of burrs. This product has been especially developed for material that is difficult to work, such as stainless steel and exotic alloys, as used in aviation and space travel and in the medical sector. In addition, it has been used successfully in the finishing of copper, bronze, aluminium, composite materials and synthetic materials. The 237AA is not suited for use on titanium.	117
The properties of the quality of the 337DC Trizact™ are similar to those of the 237AA, but the 337DC has a higher stock removal capacity.	118
This is an open nylon web structure, permeated with aluminium oxide grit and anchored by a synthetic resin on a woven polyester structure. This quality is better able to cope with aggressive applications and has a long life span. The finish of the FE quality is less uniform than that of the RC quality.	124
This is an open nylon web structure, permeated with aluminium oxide grit and anchored by a synthetic resin on a woven polyester structure. This material has a high initial cutting force, works very well at low pressure and provides a very constant, even finish. The RC is less edge resistant. Ideal for applications requiring a decorative finish.	127
This is an open nylon web structure, permeated with talc and anchored with a synthetic resin on a woven polyester structure. This quality has no abrasive properties and is specially designed to clean or polish using polishing pastes.	99





Application		Type	Backing	Weight	Type of grit	Top Coating	Waterproof	Maximum width	Grit type	
Aluminium 	Cloth	JF4T	Polyester-cotton	J/F	A/O	●	–	1420	J (60-80-100-120); F (150-180-220-320-400)	
		TZ59	Cotton	X	ZIRC.	–	–	1420	36-40-50-60-80-100-120	
		HZ72	Polyester	Y	ZIRC.	–	💧	1420	24-36-40-50-60-80	
		CJ83	Polyester-cotton	J	S/C	–	–	1420	80-100-120-150-180	
		CJ91	Polyester-cotton	J	S/C	–	–	1420	240-320	
		HC25	Polyester	H	S/C	–	💧	1420	24-36-40-60-80-100-120-150-180-220	
		237AA	Cotton	X	A/O Trizact™	–	–	660	A160 (P120)-A100 (P220)-A80 (P240)-A65 (P280)-A45 (P400)-A30 (P600)-A16 (P1400)-A6 (P2000)	
		337DC	Cotton	X	A/O Trizact™	–	–	660	A300 (P80)-A160 (P120)-A100 (P220)-A65 (P280)-A45 (P400)	
	Reinforced Tex	FE			–	A/O	–	💧	1250	COARSE - MEDIUM - VERY FINE
		RC	Polyester + Nylon web		–	A/O	–	💧	1250	COARSE - MEDIUM - VERY FINE
T00				–	–	–	💧	1270	No grit	

Trizact™ is a registered trademark of the 3M Company.

Properties	Page
High-quality aluminium oxide on a very flexible base with grinding aids. A technically innovative product with exceptional properties. Cool grinding process without discolouration. Ideally suited for high-quality finishes of medical implants, surgical instruments, knives, turbine blades, etc. Perfect grinding belt for creating a consistent and even finish on stainless steel. Its flexible base allows the JF4T to adapt easily to the shape of the workpiece.	104
High-quality aluminium/zirconium oxide on a highly resistant "X" backing. Ideal for professional applications on stainless steel, aluminium, metal, non-ferrous metals and hard wood.	106
High-quality aluminium/zirconium oxide on a heavy "Y" polyester backing. Ideal for demanding applications on stainless steel, aluminium, metal and non-ferrous metal. High cut rate. Can be used both wet and dry.	110
Silicon carbide on a flexible polyester cotton base. Ideal for working on aluminium, high quality alloys, polyesters and plastics.	115
Silicon carbide on a flexible polyester cotton base. Ideal for working on non-ferrous metals, aluminium, high-quality alloys, porcelain, polyesters and plastics.	116
Silicon carbide on a waterproof "H" polyester backing. Suited for working glass and stone, both dry and wet. Can also be used to work non-ferrous metals, aluminium, plastics, polyesters and rubber.	116
This is a product of the Trizact™ family (3M). Trizact™ is an innovative grinding material produced with perfectly calibrated aluminium oxide grit in a pyramid shape. This three-dimensional grit of identical height ensure quick stock removal and an even and replicable finish without deep scratching or risk of burrs. This product has been especially developed for material that is difficult to work, such as stainless steel and exotic alloys, as used in aviation and space travel and in the medical sector. In addition, it has been used successfully in the finishing of copper, bronze, aluminium, composite materials and synthetic materials. The 237AA is not suited for use on titanium.	117
The properties of the quality of the 337DC Trizact™ are similar to those of the 237AA, but the 337DC has a higher stock removal capacity.	118
This is an open nylon web structure, permeated with aluminium oxide grit and anchored by a synthetic resin on a woven polyester structure. This quality is better able to cope with aggressive applications and has a long life span. The finish of the FE quality is less uniform than that of the RC quality.	124
This is an open nylon web structure, permeated with aluminium oxide grit and anchored by a synthetic resin on a woven polyester structure. This material has a high initial cutting force, works very well at low pressure and provides a very constant, even finish. The RC is less edge resistant. Ideal for applications requiring a decorative finish.	127
This is an open nylon web structure, permeated with talc and anchored with a synthetic resin on a woven polyester structure. This quality has no abrasive properties and is specially designed to clean or polish using polishing pastes.	127

Application		Type	Backing	Weight	Type of grit	Top Coating	Waterproof	Maximum width	Grit type
Hard wood 	Paper	KP947F	Paper	F	A/O	-	-	1450	240-280-320-400
		KP949FO	Paper	F	A/O	-	-	1450	36-40-50-60-80-100-120-150-180-220
		KP950F	Paper	F	ZIRC.	-	-	1450	40-60-80-100-120-150-180-220
		SP706F	Paper	F	S/C	-	-	1450	24-36-40-50-60-80-100-120-150-180-220-240-280-320-400-500-600-800-1000-1200
		LKE22	Combina- tion	-	S/C	-	-	1250	16-20
	Cloth	BTX22	Cotton	X	A/O	-	-	1240	16-24-36-40-50-60-80-100-120-150-180-240
		TX52	Cotton	X	A/O	-	-	1420	16-24-36-40-50-60-80-100-120-150-180-220
		TJ7	Polyester- cotton	J	A/O	-	-	1420	60-80-100-120-150-180-220-240-320-400
		TZ59	Cotton	X	ZIRC.	-	-	1420	36-40-50-60-80-100-120
	Soft wood 	Paper	KP947F	Paper	F	A/O	-	-	1450
KP949FO			Paper	F	A/O	-	-	1450	36-40-50-60-80-100-120-150-180-220
SP706F			Paper	F	S/C	-	-	1450	24-36-40-50-60-80-100-120-150-180-220-240-280-320-400-500-600-800-1000-1200
LKE22			Combina- tion	-	S/C	-	-	1250	16-20
Cloth		BTX22	Cotton	X	A/O	-	-	1240	16-24-36-40-50-60-80-100-120-150-180-240

Properties	Page
Antistatic, close coated aluminium oxide on a very strong "F" paper base. The antistatic property ensures the easy removal of dust . The KP947F is a product that can be used for various purposes. A perfect grade for both dry and hard woods as well as for those of a softer quality with a higher level of resin.	86
Antistatic, semi-open coated aluminium oxide on a very strong "F" paper base. The antistatic property ensures the easy removal of dust . The KP949FO is a product that can be used for various purposes. Perfect grade for both dry and hard woods as well as for those of a softer quality with a higher level of resin.	86
Zirconium oxide grain on an "F" paper base. This product is ideally suited for grinding very hard and dry woods because of the extremely abrasive-resistant zirconium oxide grit. The KP950F is also highly efficient when using stainless steel.	88
Antistatic silicon carbide grit on a very strong "F" base. Ideally suited for use in sanding wooden floors and parquet.	88
Combination abrasive material. A heavy F paper reinforced with a light fabric and provided with a very open silicon carbide grit structure. Primarily for use in sanding old and dirty wooden floors and parquet. Also suitable for removing old paint, glue and varnish layers or carpet remains.	89
Aluminium oxide on an "X" cloth base. The quality is good for universal applications, with a very good price-performance ratio.	90
A heavy "X" type of cloth abrasive with high-quality aluminium oxide. Ideal for use on all types of steel and cast iron. Also suitable for grinding hard and dry woods at medium to high pressure.	99
Aluminium oxide on a flexible J-flex polyester cotton backing. Suitable for general use, for work on either metal or wood, where flexibility is important.	104
High-quality aluminium/zirconium oxide on a highly resistant "X" backing. Ideal for professional applications on stainless steel, aluminium, metal, non-ferrous metals and hard wood.	106
Antistatic, close coated aluminium oxide on a very strong "F" paper base. The antistatic property ensures the easy removal of dust . The KP947F is a product that can be used for various purposes. A perfect grade for both dry and hard woods as well as for those of a softer quality with a higher level of resin.	86
Antistatic, semi-open coated aluminium oxide on a very strong "F" paper base. The antistatic property ensures the easy removal of dust . The KP949FO is a product that can be used for various purposes. Perfect grade for both dry and hard woods as well as for those of a softer quality with a higher level of resin.	86
Antistatic silicon carbide grit on a very strong "F" base. Ideally suited for use in sanding wooden floors and parquet.	88
Combination abrasive material. A heavy F paper reinforced with a light fabric and provided with a very open silicon carbide grit structure. Primarily for use in sanding old and dirty wooden floors and parquet. Also suitable for removing old paint, glue and varnish layers or carpet remains.	89
Aluminium oxide on an "X" cloth base. The quality is good for universal applications, with a very good price-performance ratio.	90

Application		Type	Backing	Weight	Type of grit	Top Coating	Waterproof	Maximum width	Grit type
Glass & stone 	Paper	SP706F	Paper	F	S/C	–	–	1450	24-36-40-50-60-80-100-120-150-180-220-240-280-320-400-500-600-800-1000-1200
	Cloth	WC44	Cotton	X/W	S/C	–	💧	1420	280-320-400
		HC25	Polyester	H	S/C	–	💧	1420	24-36-40-60-80-100-120-150-180-220
		W445	Polyester	Y	CORK	–	💧	1320	–
Plastics & Rubber 	Cloth	WC44	Cotton	X/W	S/C	–	💧	1420	280-320-400
		CJ83	Polyester-cotton	J	S/C	–	–	1420	80-100-120-150-180
		CJ91	Polyester-cotton	J	S/C	–	–	1420	240-320
		HC25	Polyester	H	S/C	–	💧	1420	24-36-40-60-80-100-120-150-180-220
		MFX	Cotton	J	Calibrated A/O	–	💧*	500	MFX180 (P600)-MFX240 (P1200)-MFX320 (P1500)-MFX400 (P3000)-MFX600 (P3500)-MFX800 (P4000)-MFX1200 (P6000)
Car repair 	Reinforced Tex	FE	Polyester + Nylon web	–	A/O	–	💧	1250	COARSE - MEDIUM - VERY FINE
Lacquer & varnish 	Paper	SP705EO	Paper	E	S/C	●	–	1450	220-240-280-320-400-500-600-800

(*) Micro-mesh achieves the best results provided a light mist is used. The use of an excessive amount of water is not recommended with Micro-mesh.

Properties	Page
Antistatic silicon carbide grit on a very strong "F" base. Ideally suited for use in sanding wooden floors and parquet.	88
Silicon carbide on a waterproof "X" cotton backing. Suited for working glass and stone, both dry and wet. Can also be used to work non-ferrous metals, plastics, polyesters and rubber.	115
Silicon carbide on a waterproof "H" polyester backing. Suited for working glass and stone, both dry and wet. Can also be used to work non-ferrous metals, aluminium, plastics, polyesters and rubber.	116
Cork on a polyester backing. Specially designed for working glass borders. After water is added, a better finish is achieved and the life span of the belt is extended.	120
Silicon carbide on a waterproof "X" cotton backing. Suited for working glass and stone, both dry and wet. Can also be used to work non-ferrous metals, plastics, polyesters and rubber.	115
Silicon carbide on a flexible polyester cotton base. Ideal for working on aluminium, high quality alloys, polyesters and plastics.	115
Silicon carbide on a flexible polyester cotton base. Ideal for working on non-ferrous metals, aluminium, high-quality alloys, porcelain, polyesters and plastics.	116
Silicon carbide on a waterproof "H" polyester backing. Suited for working glass and stone, both dry and wet. Can also be used to work non-ferrous metals, aluminium, plastics, polyesters and rubber.	116
Micro-Mesh is a concept whereby extremely precisely calibrated grit crystals are bonded with a flexible glue on a supple cotton base. Due to the elastic positioning, this grit always comes in contact with the workpiece at a positive angle. This ensures a constant and even scratch depth. This ingeniously thought out design guarantees an extremely even, constant and precise finishing pattern.	119
This is an open nylon web structure, permeated with aluminium oxide grit and anchored by a synthetic resin on a woven polyester structure. This quality is better able to cope with aggressive applications and has a long life span. The finish of the FE quality is less uniform than that of the RC quality.	124
Antistatic silicon carbide grit on a "E" paper with the addition of zinc stearate. This paper is ideally suited for finishing. The addition of stearate ensures that the grinding process is cool and that the grit does not become saturated. Ideal for the intermediate grinding of primers, sealers, paints, varnishes, polyester and polyurethane lacquers, etc.	88

> Paper belts

A/O

PAPER



KP947F

applications	backing	weight	grit type	coating	waterproof
	Paper	F	A/O	-	-

Grit range: 240-280-320-400

Description: Antistatic, closed coated aluminium oxide on a very strong "F" paper base. The antistatic property ensures the easy removal of dust. The KP947F is a product that can be used for various purposes. Perfect grade for both dry and hard woods as well as for those of a softer quality with a higher level of resin.

Please consult Cibo on sizes, qualities and grit.

A/O

PAPER



KP949FO

applications	backing	weight	grit type	coating	waterproof
	Paper	F	A/O	-	-

Grit range: 36-40-50-60-80-100-120-150-180-220

Description: Antistatic, semi-open coated aluminium oxide on a very strong "F" paper base. The antistatic property ensures the easy removal of dust. The KP949FO is a product that can be used for various purposes. Perfect grade for both dry and hard woods as well as for those of a softer quality with a higher level of resin.

L x W	grit	code	stock	
1525x930	60	949/60/1525x930T	●	10
	80	949/80/1525x930T	●	10
	100	949/100/1525x930T	●	10
	120	949/120/1525x930T	●	10
	150	949/150/1525x930T	●	10
1900x930	60	949/60/1900x930T	●	10
	80	949/80/1900x930T	●	10
	100	949/100/1900x930T	●	10
	120	949/120/1900x930T	●	10
	150	949/150/1900x930T	●	10
1900x1100	60	949/60/1900x1100T	●	10
	80	949/80/1900x1100T	●	10
	100	949/100/1900x1100T	●	10



KP949FO

L x W	grit	code	stock	
2150x1120	120	949/120/1900x1100T	●	10
	150	949/150/1900x1100T	●	10
	60	949/60/2150x1120T	●	10
	80	949/80/2150x1120T	●	10
	100	949/100/2150x1120T	●	10
	120	949/120/2150x1120T	●	10
	150	949/150/2150x1120T	●	10
2620x1350	60	949/60/2620x1350T	●	10
	80	949/80/2620x1350T	●	10
	100	949/100/2620x1350T	●	10
	120	949/120/2620x1350T	●	10
	150	949/150/2620x1350T	●	10
6880x150	60	949/60/6880x150T	●	10
	80	949/80/6880x150T	●	10
	100	949/100/6880x150T	●	10
	120	949/120/6880x150T	●	10
	150	949/150/6880x150T	●	10
7100x150	60	949/60/7100X150T	●	10
	80	949/80/7100X150T	●	10
	100	949/100/7100X150T	●	10
	120	949/120/7100X150T	●	10
	150	949/150/7100X150T	●	10
7500x150	60	949/60/7500X150T	●	10
	80	949/80/7500X150T	●	10
	100	949/100/7500X150T	●	10
	120	949/120/7500X150T	●	10
	150	949/150/7500X150T	●	10
7800x150	60	949/60/7800X150T	●	10
	80	949/80/7800X150T	●	10
	100	949/100/7800X150T	●	10
	120	949/120/7800X150T	●	10
	150	949/150/7800X150T	●	10



● = available from stock

● = available in 5 working days

● = on request

> Paper belts

ZIRC.

PAPER



KP950F

applications	backing	weight	grit type	coating	waterproof
	Paper	F	ZIRC.	-	-

Grit range: 40-60-80-100-120-150-180-220

Description: Zirconium oxide grain on an "F" paper base. This product is ideally suited for grinding very hard and dry woods because of the extremely abrasive-resistant zirconium oxide grit. The KP950F is also highly efficient when using stainless steel.

Please consult Cibo on sizes, qualities and grit.

S/C

PAPER



SP705EO

applications	backing	weight	grit type	coating	waterproof
	Paper	E	S/C	●	-

Grit range: 220-240-280-320-400-500-600-800

Description: Antistatic silicon carbide grit on a "E" paper with the addition of zinc stearate. This paper is ideally suited for finishing. The addition of stearate ensures that the grinding process is cool and that the grit does not become saturated. Ideal for the intermediate grinding of primers, sealers, paints, varnishes, polyester and polyurethane lacquers, etc.

Please consult Cibo on sizes, qualities and grit.

S/C

PAPER



SP706F

applications	backing	weight	grit type	coating	waterproof
	Paper	F	S/C	-	-

Grit range: 24-36-40-50-60-80-100-120-150-180-220-240-280-320-400-500-600-800-1000-1200

Description: Antistatic silicon carbide grit on a very strong "F" base. Ideally suited for use in sanding wooden floors and parquet.

Please consult Cibo on sizes, qualities and grit.

➤ Paper belts

LKE22

PAPER

S/C

applications	backing	weight	grit type	coating	waterproof
	Combina- tion	-	S/C	-	-

Grit range: 16-20

Description: Combination abrasive material. A heavy F paper reinforced with a light fabric and provided with a very open silicon carbide grit structure. Primarily for use in sanding old and dirty wooden floors and parquet. Also suitable for removing old paint, glue and varnish layers or carpet remains.

Please consult Cibo on sizes, qualities and grit.



● = available from stock

● = available in 5 working days

● = on request

> Cloth belts

Length 305 mm

A/O

CLOTH ABRASIVES

BTX22



applications	backing	weight	grit type	coating	waterproof
	Cotton	X	A/O	-	-

Grit range: 16-24-36-40-50-60-80-100-120-150-180-240

Description: Aluminium oxide on an "X" cloth base. The quality is good for universal applications, with a very good price-performance ratio.

L x W	grit	code	stock	
305x40	16	BTX22/16/305x40B	●	10
	24	BTX22/24/305x40B	●	10
	36	BTX22/36/305x40B	●	10
	40	BTX22/40/305x40B	●	10
	50	BTX22/50/305x40B	●	10
	60	BTX22/60/305x40B	●	10
	80	BTX22/80/305x40B	●	10
	100	BTX22/100/305x40B	●	10
	120	BTX22/120/305x40B	●	10
	150	BTX22/150/305x40B	●	10
	180	BTX22/180/305x40B	●	10





Length of 400 to 408 mm

BTX22

L x W	grit	code	stock	
400x60	16	BTX22/16/400X60B	●	10
	24	BTX22/24/400X60B	●	10
	36	BTX22/36/400X60B	●	10
	40	BTX22/40/400X60B	●	10
	50	BTX22/50/400X60B	●	10
	60	BTX22/60/400X60B	●	10
	80	BTX22/80/400X60B	●	10
	100	BTX22/100/400X60B	●	10
	120	BTX22/120/400X60B	●	10
	150	BTX22/150/400X60B	●	10
405x63	16	BTX22/16/405X63B	●	10
	24	BTX22/24/405X63B	●	10
	36	BTX22/36/405X63B	●	10
	40	BTX22/40/405X63B	●	10
	50	BTX22/50/405X63B	●	10
	60	BTX22/60/405X63B	●	10
	80	BTX22/80/405X63B	●	10
	100	BTX22/100/405X63B	●	10
	120	BTX22/120/405X63B	●	10
	150	BTX22/150/405X63B	●	10
408x65	16	BTX22/16/408X65B	●	10
	24	BTX22/24/408X65B	●	10
	36	BTX22/36/408X65B	●	10
	40	BTX22/40/408X65B	●	10
	50	BTX22/50/408X65B	●	10
	60	BTX22/60/408X65B	●	10
	80	BTX22/80/408X65B	●	10
	100	BTX22/100/408X65B	●	10
	120	BTX22/120/408X65B	●	10
	150	BTX22/150/408X65B	●	10
180	BTX22/180/408X65B	●	10	



● = available from stock

● = available in 5 working days

● = on request





Length of 451 to 480 mm

BTX22



L x W	grit	code	stock	
451x13	16	BTX22/16/451X13B	●	20
	24	BTX22/24/451X13B	●	20
	36	BTX22/36/451X13B	●	20
	40	BTX22/40/451X13B	●	20
	50	BTX22/50/451X13B	●	20
	60	BTX22/60/451X13B	●	20
	80	BTX22/80/451X13B	●	20
	100	BTX22/100/451X13B	●	20
	120	BTX22/120/451X13B	●	20
	150	BTX22/150/451X13B	●	20
457x75	16	BTX22/16/457X75B	●	10
	24	BTX22/24/457X75B	●	10
	36	BTX22/36/457X75B	●	10
	40	BTX22/40/457X75B	●	10
	50	BTX22/50/457X75B	●	10
	60	BTX22/60/457X75B	●	10
	80	BTX22/80/457X75B	●	10
	100	BTX22/100/457X75B	●	10
	120	BTX22/120/457X75B	●	10
	150	BTX22/150/457X75B	●	10
480x75	16	BTX22/16/480X75B	●	10
	24	BTX22/24/480X75B	●	10
	36	BTX22/36/480X75B	●	10
	40	BTX22/40/480X75B	●	10
	50	BTX22/50/480X75B	●	10
	60	BTX22/60/480X75B	●	10
	80	BTX22/80/480X75B	●	10
	100	BTX22/100/480X75B	●	10
	120	BTX22/120/480X75B	●	10
	150	BTX22/150/480X75B	●	10
180	BTX22/180/480X75B	●	10	





Length of 508 to 533 mm

BTX22

L x W	grit	code	stock	
508x75	16	BTX22/16/508X75B	●	10
	24	BTX22/24/508X75B	●	10
	36	BTX22/36/508X75B	●	10
	40	BTX22/40/508X75B	●	10
	50	BTX22/50/508X75B	●	10
	60	BTX22/60/508X75B	●	10
	80	BTX22/80/508X75B	●	10
	100	BTX22/100/508X75B	●	10
	120	BTX22/120/508X75B	●	10
	150	BTX22/150/508X75B	●	10
533x75	16	BTX22/16/533X75B	●	10
	24	BTX22/24/533X75B	●	10
	36	BTX22/36/533X75B	●	10
	40	BTX22/40/533X75B	●	10
	50	BTX22/50/533X75B	●	10
	60	BTX22/60/533X75B	●	10
	80	BTX22/80/533X75B	●	10
	100	BTX22/100/533X75B	●	10
	120	BTX22/120/533X75B	●	10
	150	BTX22/150/533X75B	●	10
533x100	16	BTX22/16/533X100B	●	10
	24	BTX22/24/533X100B	●	10
	36	BTX22/36/533X100B	●	10
	40	BTX22/40/533X100B	●	10
	50	BTX22/50/533X100B	●	10
	60	BTX22/60/533X100B	●	10
	80	BTX22/80/533X100B	●	10
	100	BTX22/100/533X100B	●	10
	120	BTX22/120/533X100B	●	10
	150	BTX22/150/533X100B	●	10
180	BTX22/180/533X100B	●	10	



● = available from stock

● = available in 5 working days

● = on request





Length of 552 to 560 mm

BTX22					
L x W	grit	code		stock	
552x100	16	BTX22/16/552X100B		●	10
	24	BTX22/24/552X100B		●	10
	36	BTX22/36/552X100B		●	10
	40	BTX22/40/552X100B		●	10
	50	BTX22/50/552X100B		●	10
	60	BTX22/60/552X100B		●	10
	80	BTX22/80/552X100B		●	10
	100	BTX22/100/552X100B		●	10
	120	BTX22/120/552X100B		●	10
	150	BTX22/150/552X100B		●	10
551x200	16	BTX22/16/551x200B		●	10
	24	BTX22/24/551x200B		●	10
	36	BTX22/36/551x200B		●	10
	40	BTX22/40/551x200B		●	10
	50	BTX22/50/551x200B		●	10
	60	BTX22/60/551x200B		●	10
	80	BTX22/80/551x200B		●	10
	100	BTX22/100/551x200B		●	10
	120	BTX22/120/551x200B		●	10
	150	BTX22/150/551x200B		●	10
560x100	16	BTX22/16/560X100B		●	10
	24	BTX22/24/560X100B		●	10
	36	BTX22/36/560X100B		●	10
	40	BTX22/40/560X100B		●	10
	50	BTX22/50/560X100B		●	10
	60	BTX22/60/560X100B		●	10
	80	BTX22/80/560X100B		●	10
	100	BTX22/100/560X100B		●	10
	120	BTX22/120/560X100B		●	10
	150	BTX22/150/560X100B		●	10
	180	BTX22/180/560X100B		●	10





Length of 575 to 610 mm

BTX22

L x W	grit	code	stock	
575x75	16	BTX22/16/575X75B	●	10
	24	BTX22/24/575X75B	●	10
	36	BTX22/36/575X75B	●	10
	40	BTX22/40/575X75B	●	10
	50	BTX22/50/575X75B	●	10
	60	BTX22/60/575X75B	●	10
	80	BTX22/80/575X75B	●	10
	100	BTX22/100/575X75B	●	10
	120	BTX22/120/575X75B	●	10
	150	BTX22/150/575X75B	●	10
608x75	16	BTX22/16/608X75B	●	10
	24	BTX22/24/608X75B	●	10
	36	BTX22/36/608X75B	●	10
	40	BTX22/40/608X75B	●	10
	50	BTX22/50/608X75B	●	10
	60	BTX22/60/608X75B	●	10
	80	BTX22/80/608X75B	●	10
	100	BTX22/100/608X75B	●	10
	120	BTX22/120/608X75B	●	10
	150	BTX22/150/608X75B	●	10
610x100	16	BTX22/16/610X100B	●	10
	24	BTX22/24/610X100B	●	10
	36	BTX22/36/610X100B	●	10
	40	BTX22/40/610X100B	●	10
	50	BTX22/50/610X100B	●	10
	60	BTX22/60/610X100B	●	10
	80	BTX22/80/610X100B	●	10
	100	BTX22/100/610X100B	●	10
	120	BTX22/120/610X100B	●	10
	150	BTX22/150/610X100B	●	10
180	BTX22/180/610X100B	●	10	



● = available from stock

● = available in 5 working days

● = on request





Length of 620 to 750 mm

BTX22

L x W	grit	code	stock	
620x100	16	BTX22/16/620X100B	●	10
	24	BTX22/24/620X100B	●	10
	36	BTX22/36/620X100B	●	10
	40	BTX22/40/620X100B	●	10
	50	BTX22/50/620X100B	●	10
	60	BTX22/60/620X100B	●	10
	80	BTX22/80/620X100B	●	10
	100	BTX22/100/620X100B	●	10
	120	BTX22/120/620X100B	●	10
	150	BTX22/150/620X100B	●	10
620x110	16	BTX22/16/620X110B	●	10
	24	BTX22/24/620X110B	●	10
	36	BTX22/36/620X110B	●	10
	40	BTX22/40/620X110B	●	10
	50	BTX22/50/620X110B	●	10
	60	BTX22/60/620X110B	●	10
	80	BTX22/80/620X110B	●	10
	100	BTX22/100/620X110B	●	10
	120	BTX22/120/620X110B	●	10
	150	BTX22/150/620X110B	●	10
750x200	16	BTX22/16/750x200B	●	10
	24	BTX22/24/750x200B	●	10
	36	BTX22/36/750x200B	●	10
	40	BTX22/40/750x200B	●	10
	50	BTX22/50/750x200B	●	10
	60	BTX22/60/750x200B	●	10
	80	BTX22/80/750x200B	●	10
	100	BTX22/100/750x200B	●	10
	120	BTX22/120/750x200B	●	10
	150	BTX22/150/750x200B	●	10
	180	BTX22/180/750x200B	●	10





Length of 860 to 920 mm

BTX22

L x W	grit	code	stock	
860x100	16	BTX22/16/860X100B	●	10
	24	BTX22/24/860X100B	●	10
	36	BTX22/36/860X100B	●	10
	40	BTX22/40/860X100B	●	10
	50	BTX22/50/860X100B	●	10
	60	BTX22/60/860X100B	●	10
	80	BTX22/80/860X100B	●	10
	100	BTX22/100/860X100B	●	10
	120	BTX22/120/860X100B	●	10
	150	BTX22/150/860X100B	●	10
900x100	16	BTX22/16/900X100B	●	10
	24	BTX22/24/900X100B	●	10
	36	BTX22/36/900X100B	●	10
	40	BTX22/40/900X100B	●	10
	50	BTX22/50/900X100B	●	10
	60	BTX22/60/900X100B	●	10
	80	BTX22/80/900X100B	●	10
	100	BTX22/100/900X100B	●	10
	120	BTX22/120/900X100B	●	10
	150	BTX22/150/900X100B	●	10
920x100	16	BTX22/16/920X100B	●	10
	24	BTX22/24/920X100B	●	10
	36	BTX22/36/920X100B	●	10
	40	BTX22/40/920X100B	●	10
	50	BTX22/50/920X100B	●	10
	60	BTX22/60/920X100B	●	10
	80	BTX22/80/920X100B	●	10
	100	BTX22/100/920X100B	●	10
	120	BTX22/120/920X100B	●	10
	150	BTX22/150/920X100B	●	10
180	BTX22/180/920X100B	●	10	



● = available from stock

● = available in 5 working days

● = on request





Length 1000 mm

BTX22



L x W	grit	code	stock	
1000x100	16	BTX22/16/1000X100B	●	10
	24	BTX22/24/1000X100B	●	10
	36	BTX22/36/1000X100B	●	10
	40	BTX22/40/1000X100B	●	10
	50	BTX22/50/1000X100B	●	10
	60	BTX22/60/1000X100B	●	10
	80	BTX22/80/1000X100B	●	10
	100	BTX22/100/1000X100B	●	10
	120	BTX22/120/1000X100B	●	10
	150	BTX22/150/1000X100B	●	10
1000x200	16	BTX22/16/1000X200B	●	10
	24	BTX22/24/1000X200B	●	10
	36	BTX22/36/1000X200B	●	10
	40	BTX22/40/1000X200B	●	10
	50	BTX22/50/1000X200B	●	10
	60	BTX22/60/1000X200B	●	10
	80	BTX22/80/1000X200B	●	10
	100	BTX22/100/1000X200B	●	10
	120	BTX22/120/1000X200B	●	10
	150	BTX22/150/1000X200B	●	10
180	BTX22/180/1000X200B	●	10	



Cloth belts

Length of 551 to 552 mm

TX52

CLOTH ABRASIVES

A/O

applications	backing	weight	grit type	coating	waterproof
	Cotton	X	A/O	-	-

Grit range: 16-24-36-40-50-60-80-100-120-150-180-220

Description: A heavy "X" type of cloth abrasive with high-quality aluminium oxide. Ideal for use on all types of steel and cast iron. Also suitable for grinding hard and dry woods at medium to high pressure.

L x W	grit	code	stock	
551x200	16	TX52/16/551x200B	●	10
	24	TX52/24/551x200B	●	10
	36	TX52/36/551x200B	●	10
	40	TX52/40/551x200B	●	10
	50	TX52/50/551x200B	●	10
	60	TX52/60/551x200B	●	10
	80	TX52/80/551x200B	●	10
	100	TX52/100/551x200B	●	10
	120	TX52/120/551x200B	●	10
	150	TX52/150/551x200B	●	10
552x100	16	TX52/16/552X100B	●	10
	24	TX52/24/552X100B	●	10
	36	TX52/36/552X100B	●	10
	40	TX52/40/552X100B	●	10
	50	TX52/50/552X100B	●	10
	60	TX52/60/552X100B	●	10
	80	TX52/80/552X100B	●	10
	100	TX52/100/552X100B	●	10
	120	TX52/120/552X100B	●	10
	150	TX52/150/552X100B	●	10
180	TX52/180/552X100B	●	10	

>>



Please consult Cibo on sizes, qualities and grit.

● = available from stock

● = available in 5 working days

● = on request



>>

Length of 560 to 620 mm

TX52

L x W	grit	code	stock	
560x100	16	TX52/16/560X100B	●	10
	24	TX52/24/560X100B	●	10
	36	TX52/36/560X100B	●	10
	40	TX52/40/560X100B	●	10
	50	TX52/50/560X100B	●	10
	60	TX52/60/560X100B	●	10
	80	TX52/80/560X100B	●	10
	100	TX52/100/560X100B	●	10
	120	TX52/120/560X100B	●	10
	150	TX52/150/560X100B	●	10
610x100	16	TX52/16/610X100B	●	10
	24	TX52/24/610X100B	●	10
	36	TX52/36/610X100B	●	10
	40	TX52/40/610X100B	●	10
	50	TX52/50/610X100B	●	10
	60	TX52/60/610X100B	●	10
	80	TX52/80/610X100B	●	10
	100	TX52/100/610X100B	●	10
	120	TX52/120/610X100B	●	10
	150	TX52/150/610X100B	●	10
620x100	16	TX52/16/620X100B	●	10
	24	TX52/24/620X100B	●	10
	36	TX52/36/620X100B	●	10
	40	TX52/40/620X100B	●	10
	50	TX52/50/620X100B	●	10
	60	TX52/60/620X100B	●	10
	80	TX52/80/620X100B	●	10
	100	TX52/100/620X100B	●	10
	120	TX52/120/620X100B	●	10
	150	TX52/150/620X100B	●	10
180	TX52/180/620X100B	●	10	

>>



Length of 620 to 860 mm

TX52

L x W	grit	code	stock	
620x110	16	TX52/16/620X110B	●	10
	24	TX52/24/620X110B	●	10
	36	TX52/36/620X110B	●	10
	40	TX52/40/620X110B	●	10
	50	TX52/50/620X110B	●	10
	60	TX52/60/620X110B	●	10
	80	TX52/80/620X110B	●	10
	100	TX52/100/620X110B	●	10
	120	TX52/120/620X110B	●	10
	150	TX52/150/620X110B	●	10
750x200	16	TX52/16/750x200B	●	10
	24	TX52/24/750x200B	●	10
	36	TX52/36/750x200B	●	10
	40	TX52/40/750x200B	●	10
	50	TX52/50/750x200B	●	10
	60	TX52/60/750x200B	●	10
	80	TX52/80/750x200B	●	10
	100	TX52/100/750x200B	●	10
	120	TX52/120/750x200B	●	10
	150	TX52/150/750x200B	●	10
860x100	16	TX52/16/860X100B	●	10
	24	TX52/24/860X100B	●	10
	36	TX52/36/860X100B	●	10
	40	TX52/40/860X100B	●	10
	50	TX52/50/860X100B	●	10
	60	TX52/60/860X100B	●	10
	80	TX52/80/860X100B	●	10
	100	TX52/100/860X100B	●	10
	120	TX52/120/860X100B	●	10
	150	TX52/150/860X100B	●	10
180	TX52/180/860X100B	●	10	



● = available from stock

● = available in 5 working days

● = on request



>>

Length of 900 to 920 mm

TX52



L x W	grit	code	stock	
900x100	16	TX52/16/900X100B	●	10
	24	TX52/24/900X100B	●	10
	36	TX52/36/900X100B	●	10
	40	TX52/40/900X100B	●	10
	50	TX52/50/900X100B	●	10
	60	TX52/60/900X100B	●	10
	80	TX52/80/900X100B	●	10
	100	TX52/100/900X100B	●	10
	120	TX52/120/900X100B	●	10
	150	TX52/150/900X100B	●	10
920x100	16	TX52/16/920X100B	●	10
	24	TX52/24/920X100B	●	10
	36	TX52/36/920X100B	●	10
	40	TX52/40/920X100B	●	10
	50	TX52/50/920X100B	●	10
	60	TX52/60/920X100B	●	10
	80	TX52/80/920X100B	●	10
	100	TX52/100/920X100B	●	10
	120	TX52/120/920X100B	●	10
	150	TX52/150/920X100B	●	10
180	TX52/180/920X100B	●	10	

>>





Length 1000 mm

TX52

L x W	grit	code	stock	
1000x100	16	TX52/16/1000X100B	●	10
	24	TX52/24/1000X100B	●	10
	36	TX52/36/1000X100B	●	10
	40	TX52/40/1000X100B	●	10
	50	TX52/50/1000X100B	●	10
	60	TX52/60/1000X100B	●	10
	80	TX52/80/1000X100B	●	10
	100	TX52/100/1000X100B	●	10
	120	TX52/120/1000X100B	●	10
	150	TX52/150/1000X100B	●	10
1000x200	16	TX52/16/1000X200B	●	10
	24	TX52/24/1000X200B	●	10
	36	TX52/36/1000X200B	●	10
	40	TX52/40/1000X200B	●	10
	50	TX52/50/1000X200B	●	10
	60	TX52/60/1000X200B	●	10
	80	TX52/80/1000X200B	●	10
	100	TX52/100/1000X200B	●	10
	120	TX52/120/1000X200B	●	10
	150	TX52/150/1000X200B	●	10
180	TX52/180/1000X200B	●	10	



● = available from stock

● = available in 5 working days

● = on request

> Cloth belts

A/O

CLOTH ABRASIVES

TJ7 - OPEN BELTS WITH GRIP LOCK



Open belts are the ideal solution for working closed tube constructions. The open belts are supplied with a corresponding grip lock.

applications		backing	weight	grit type	coating	waterproof
		Polyester-Cotton	J	A/O	-	-
Grit range: 60-80-100-120-150-180-220-240-320-400						
Description: Aluminium oxide on a flexible J-flex polyester cotton backing. Suitable for general use, for work on either metal or wood, where flexibility is important.						
L x W	grit	code			stock	
600x40	60	FMGRL/60/60040			●	10
	80	FMGRL/80/60040			●	10
	100	FMGRL/100/60040			●	10
	120	FMGRL/120/60040			●	10
	220	FMGRL/220/60040			●	10
	320	FMGRL/320/60040			●	10

A/O

CLOTH ABRASIVES

JF4T





This type of belt is very suited for working round-shaped stainless steel workpieces.

applications		backing	weight	grit type	coating	waterproof
		Polyester-Cotton	J/F	A/O	●	-
Grit range: J (60-80-100-120); F (150-180-220-320-400)						
Description: High-quality aluminium oxide on a very flexible base with grinding aids. A technically innovative product with exceptional properties. Cool grinding process without discolouration. Ideally suited for high-quality finishing of medical implants, surgical instruments, knives, turbine blades, etc. Ideal quality for creating a consistent and equal finish on stainless steel. Its flexible base allows the JF4T to adapt easily to the shape of the workpiece.						
L x W	grit	code			stock	
675x40	60	JF4T/60/675x40B			●	10
	80	JF4T/80/675x40B			●	10
	120	JF4T/120/675x40B			●	10
	150	JF4T/150/675x40B			●	10
	180	JF4T/180/675x40B			●	10
	220	JF4T/220/675x40B			●	10
	320	JF4T/320/675x40B			●	10
	400	JF4T/400/675x40B			●	10

Cloth belts

HA66

applications	backing	weight	grit type	coating	waterproof
	Polyester	H	A/O	-	

Grit range: 80-100-120-150-180-220-240-320-400-500

Description: High-quality aluminium oxide on "H" polyester backing. Can be applied to either a dry or wet surface. Mainly for use on all types of iron and steel. Suitable for heavier applications due to the tear-resistant polyester backing.



Please consult Cibo on sizes, qualities and grit.

CLOTH ABRASIVES

A/O



PG730

applications	backing	weight	grit type	coating	waterproof
	Polyester	H	A/O Compact	-	

Grit range: 80-120-240-320-400-600

Description: Aluminium oxide compact grit on a polyester backing. At the onset, this compact grit has a slightly lower speed of cut, but it more than makes up for this by its extremely long life span (3 to 5 times longer is no exception). The PG730 can operate under heavy working pressure, both wet and dry.

Please consult Cibo on sizes, qualities and grit.

CLOTH ABRASIVES

A/O COMPACT



Tips & tricks: Crimped abrasive belts

Finishing work pieces with upward edges is no picnic. Straight abrasive belts can tend to cut into the workpiece or leave a mark on the upward edge. The crimped abrasive belt provides a solution. The crimped edge of the abrasive belt makes the edge of the belt less stiff. This makes it easier for the belt to follow the edge of the workpiece without leaving any marks on the workpiece.

More information? Contact Cibo at **+32 (0) 16 61 85 85** or send an email to **info@cibo.be!**

> Cloth belts

Length of 287 to 450 mm

ZIRC.

CLOTH ABRASIVES

TZ59



applications		backing	weight	grit type	coating	waterproof
		Cotton	X	ZIRC.	-	-
Grit range:		36-40-50-60-80-100-120				
Description:		High-quality aluminium/zirconium oxide on a highly resistant "X" backing. Ideal for professional applications on stainless steel, aluminium, metal, non-ferrous metals and hard wood.				
L x W	grit	code			stock	
287x100	40	FMTZ59/40/287x100			●	10
	60	FMTZ59/60/287x100			●	10
	80	FMTZ59/80/287x100			●	10
	100	FMTZ59/100/287x100			●	10
	120	FMTZ59/120/287x100B			●	10
293x100	40	FMTZ59/40/293x100			●	10
	60	FMTZ59/60/293x100			●	10
	80	FMTZ59/80/293x100			●	10
	100	FMTZ59/100/293x100			●	10
	120	FMTZ59/120/293x100			●	10
385x100	40	TZ59/40/385x100B			●	10
	60	TZ59/60/385x100B			●	10
	80	TZ59/80/385x100B			●	10
	100	TZ59/100/385x100B			●	10
	120	TZ59/120/385x100B			●	10
450x20	40	TZ59/40/450x20B			●	20
	60	TZ59/60/450x20B			●	20
	80	TZ59/80/450x20B			●	20
	120	TZ59/120/450x20B			●	20
450x30	40	TZ59/40/450x30B			●	20
	60	TZ59/60/450x30B			●	20
	80	TZ59/80/450x30B			●	20
	120	TZ59/120/450x30B			●	20
450x50	40	TZ59/40/450x50B			●	20
	60	TZ59/60/450x50B			●	20
	80	TZ59/80/450x50B			●	20
	120	TZ59/120/450x50B			●	20



Length of 457 to 520 mm

TZ59

L x W	grit	code	stock	
457x13	40	TZ59/40/457x13B	●	20
	60	TZ59/60/457x13B	●	20
	80	TZ59/80/457x13B	●	20
	120	TZ59/120/457x13B	●	20
457x19	40	TZ59/40/457x19B	●	20
	60	TZ59/60/457x19B	●	20
	80	TZ59/80/457x19B	●	20
	120	TZ59/120/457x19B	●	20
457x6	40	TZ59/40/457x6B	●	20
	60	TZ59/60/457x6B	●	20
	80	TZ59/80/457x6B	●	20
	120	TZ59/120/457x6B	●	20
457x9	40	TZ59/40/457x9B	●	20
	60	TZ59/60/457x9B	●	20
	80	TZ59/80/457x9B	●	20
	120	TZ59/120/457x9B	●	20
463x13	40	TZ59/40/463x13B	●	20
	60	TZ59/60/463x13B	●	20
	80	TZ59/80/463x13B	●	20
	120	TZ59/120/463x13B	●	20
463x19	40	TZ59/40/463x19B	●	20
	60	TZ59/60/463x19B	●	20
	80	TZ59/80/463x19B	●	20
	120	TZ59/120/463x19B	●	20
520x13	40	TZ59/40/520x13B	●	20
	60	TZ59/60/520x13B	●	20
	80	TZ59/80/520x13B	●	20
	120	TZ59/120/520x13B	●	20
520x16	40	TZ59/40/520x16B	●	20
	60	TZ59/60/520x16B	●	20
	80	TZ59/80/520x16B	●	20
	120	TZ59/120/520x16B	●	20



● = available from stock

● = available in 5 working days

● = on request



>>

Length of 520 to 610 mm

TZ59

L x W	grit	code	stock	
520x20	40	TZ59/40/520x20B	●	20
	60	TZ59/60/520x20B	●	20
	80	TZ59/80/520x20B	●	20
	120	TZ59/120/520x20B	●	20
520x30	40	TZ59/40/520x30B	●	20
	60	TZ59/60/520x30B	●	20
	80	TZ59/80/520x30B	●	20
	120	TZ59/120/520x30B	●	20
520x6	40	TZ59/40/520x6B	●	20
	60	TZ59/60/520x6B	●	20
	80	TZ59/80/520x6B	●	20
	120	TZ59/120/520x6B	●	20
533x13	40	TZ59/40/533x13B	●	20
	60	TZ59/60/533x13B	●	20
	80	TZ59/80/533x13B	●	20
	120	TZ59/120/533x13B	●	20
533x9	40	TZ59/40/533x9B	●	20
	60	TZ59/60/533x9B	●	20
	80	TZ59/80/533x9B	●	20
	120	TZ59/120/533x9B	●	20
610x13	40	TZ59/40/610x13B	●	20
	60	TZ59/60/610x13B	●	20
	80	TZ59/80/610x13B	●	20
	120	TZ59/120/610x13B	●	20
610x6	40	TZ59/40/610x6B	●	20
	60	TZ59/60/610x6B	●	20
	80	TZ59/80/610x6B	●	20
	120	TZ59/120/610x6B	●	20

>>



Please consult Cibo on sizes, qualities and grit.



Length of 620 to 675 mm

TZ59

L x W	grit	code	stock	
620x40	40	TZ59/40/620x40B	●	20
	60	TZ59/60/620x40B	●	20
	80	TZ59/80/620x40B	●	20
	120	TZ59/120/620x40B	●	20
675x40	40	TZ59/40/675x40B	●	10
	60	TZ59/60/675x40B	●	10
	80	TZ59/80/675x40B	●	10
	100	TZ59/100/675x40B	●	10
	120	TZ59/120/675x40B	●	10



TZ59 – FOR STATIONARY BELT GRINDER

L x W	grit	code	stock	
2000x75	36	TZ59/36/2000x75B	●	10
	40	TZ59/40/2000x75B	●	10
	60	TZ59/60/2000x75B	●	10
	80	TZ59/80/2000x75B	●	10
	100	TZ59/100/2000x75B	●	10
	120	TZ59/120/2000x75B	●	10
2000x150	36	TZ59/36/2000x150B	●	10
	40	TZ59/40/2000x150B	●	10
	60	TZ59/60/2000x150B	●	10
	80	TZ59/80/2000x150B	●	10
	100	TZ59/100/2000x150B	●	10
	120	TZ59/120/2000x150B	●	10

CLOTH ABRASIVES

ZIRC.



● = available from stock

● = available in 5 working days

● = on request

> Cloth belts

ZIRC.

CLOTH ABRASIVES



HZ72 - FOR STATIONARY BELT GRINDER

applications	backing	weight	grit type	coating	waterproof
	Polyester	Y	ZIRC.	-	

Grit range: 24-36-40-50-60-80

Description: High-quality aluminium/zirconium oxide on a heavy "Y" polyester backing. Ideal for demanding applications on stainless steel, aluminium, metal and non-ferrous metal. High cut rate. Can be used both wet and dry.

L x W	grit	code	stock	
2000x75	24	HZ72/24/2000x75B	●	10
	36	HZ72/36/2000x75B	●	10
	40	HZ72/40/2000x75B	●	10
	50	HZ72/50/2000x75B	●	10
	60	HZ72/60/2000x75B	●	10
	80	HZ72/80/2000x75B	●	10
2000x150	24	HZ72/24/2000x150B	●	10
	36	HZ72/36/2000x150B	●	10
	40	HZ72/40/2000x150B	●	10
	50	HZ72/50/2000x150B	●	10
	60	HZ72/60/2000x150B	●	10
	80	HZ72/80/2000x150B	●	10



➤ Cloth belts

HZ8T – FOR STATIONARY BELT GRINDER

CLOTH ABRASIVES

ZIRC.

applications	backing	weight	grit type	coating	waterproof
	Polyester	Y/H	ZIRC.	●	💧

Grit range: 36-40-50-60-80

Description: 100% zirconium oxide grit on a heavy “Y” polyester backing with grinding aids. The pure zirconium oxide ensures an extremely fast grinding process, whilst the active abrasive ingredient guarantees a very cool grinding process. This top product is ideal for heavy and fast grinding of primarily stainless steel and very hard types of steel.

L x W	grit	code	stock	
2000x75	36	HZ8T/36/2000x75B	●	10
	40	HZ8T/40/2000x75B	●	10
	50	HZ8T/50/2000x75B	●	10
	60	HZ8T/60/2000x75B	●	10
	80	HZ8T/80/2000x75B	●	10
2000x150	36	HZ8T/36/2000x150B	●	10
	40	HZ8T/40/2000x150B	●	10
	50	HZ8T/50/2000x150B	●	10
	60	HZ8T/60/2000x150B	●	10
	80	HZ8T/80/2000x150B	●	10



● = available from stock

● = available in 5 working days

● = on request

> Cloth belts

Length of 450 to 457 mm

CER.

CLOTH ABRASIVES

HG49T



applications	backing	weight	grit type	coating	waterproof
	Polyester	Y	CER.	●	

Grit range: 36-40-50-60-80

Description: A high-quality ceramic grinding grit on a heavy "Y" tear-resistant polyester backing with grinding aids. This absolute top of the range product has a very high stock removal capacity on hard and highly alloyed steel types. Operates extremely well under high operating pressure on a hard to very hard grinding contact.

L x W	grit	code	stock	
450x20	40	HG49T/40/450x20B	●	20
	60	HG49T/60/450x20B	●	20
	80	HG49T/80/450x20B	●	20
450x30	40	HG49T/40/450x30B	●	20
	60	HG49T/60/450x30B	●	20
	80	HG49T/80/450x30B	●	20
450x50	40	HG49T/40/450x50B	●	20
	60	HG49T/60/450x50B	●	20
	80	HG49T/80/450x50B	●	20
457x6	40	HG49T/40/457x6B	●	20
	60	HG49T/60/457x6B	●	20
	80	HG49T/80/457x6B	●	20
457x9	40	HG49T/40/457x9B	●	20
	60	HG49T/60/457x9B	●	20
	80	HG49T/80/457x9B	●	20
457x13	40	HG49T/40/457x13B	●	20
	60	HG49T/60/457x13B	●	20
	80	HG49T/80/457x13B	●	20
457x19	40	HG49T/40/457x19B	●	20
	60	HG49T/60/457x19B	●	20
	80	HG49T/80/457x19B	●	20





Length of 463 to 610 mm

HG49T

L x W	grit	code	stock	
463x13	40	HG49T/40/463x13B	●	20
	60	HG49T/60/463x13B	●	20
	80	HG49T/80/463x13B	●	20
463x19	40	HG49T/40/463x19B	●	20
	60	HG49T/60/463x19B	●	20
	80	HG49T/80/463x19B	●	20
520x6	40	HG49T/40/520x6B	●	20
	60	HG49T/60/520x6B	●	20
	80	HG49T/80/520x6B	●	20
520x13	40	HG49T/40/520x13B	●	20
	60	HG49T/60/520x13B	●	20
	80	HG49T/80/520x13B	●	20
520x16	40	HG49T/40/520x16B	●	20
	60	HG49T/60/520x16B	●	20
	80	HG49T/80/520x16B	●	20
520x20	40	HG49T/40/520x20B	●	20
	60	HG49T/60/520x20B	●	20
	80	HG49T/80/520x20B	●	20
520x30	40	HG49T/40/520x30B	●	20
	60	HG49T/60/520x30B	●	20
	80	HG49T/80/520x30B	●	20
533x9	40	HG49T/40/533x9B	●	20
	60	HG49T/60/533x9B	●	20
	80	HG49T/80/533x9B	●	20
533x13	40	HG49T/40/533x13B	●	20
	60	HG49T/60/533x13B	●	20
	80	HG49T/80/533x13B	●	20
610x6	40	HG49T/40/610x6B	●	20
	60	HG49T/60/610x6B	●	20
	80	HG49T/80/610x6B	●	20
610x13	40	HG49T/40/610x13B	●	20
	60	HG49T/60/610x13B	●	20
	80	HG49T/80/610x13B	●	20



● = available from stock

● = available in 5 working days

● = on request

➤ Cloth belts

CER.

CLOTH ABRASIVES

HG49T - FOR STATIONARY BELT GRINDER



L x W	grit	code	stock	
2000x75	36	HG49T/36/2000x75B	●	10
	40	HG49T/40/2000x75B	●	10
	50	HG49T/50/2000x75B	●	10
	60	HG49T/60/2000x75B	●	10
	80	HG49T/80/2000x75B	●	10
2000x150	36	HG49T/36/2000x150B	●	10
	40	HG49T/40/2000x150B	●	10
	50	HG49T/50/2000x150B	●	10
	60	HG49T/60/2000x150B	●	10
	80	HG49T/80/2000x150B	●	10

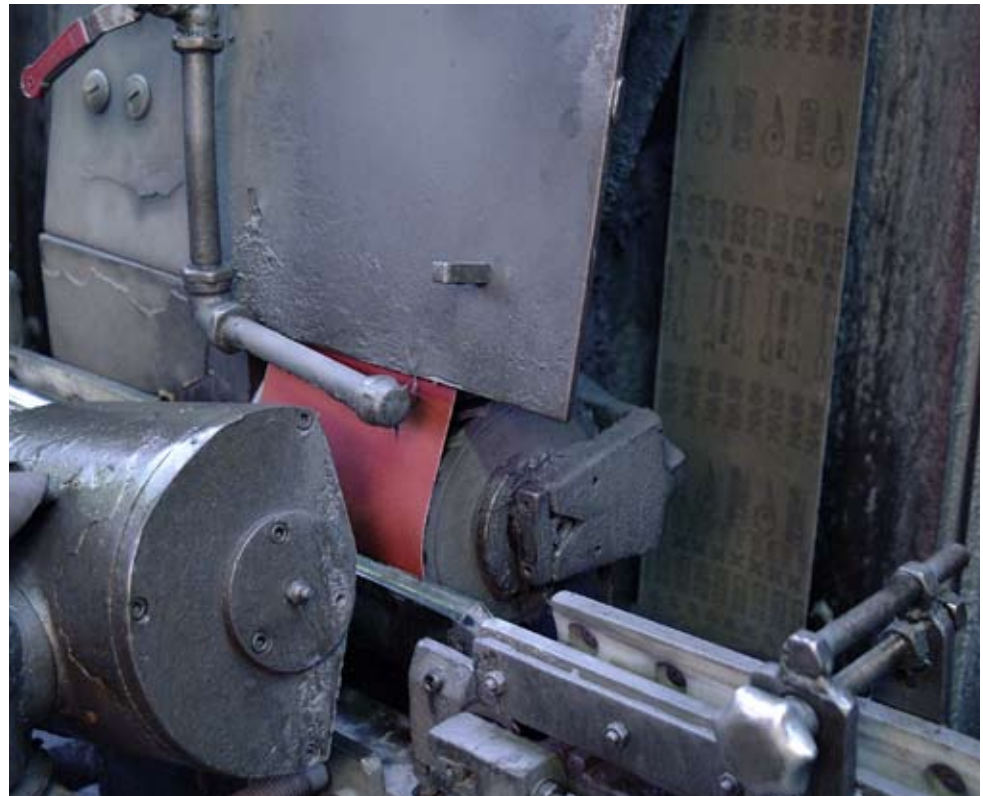

> Cloth belts

777F

CLOTH ABRASIVES

CER.

applications	backing	weight	grit type	coating	waterproof
	Polyester	H	CER.	●	●

Grit range: 40-60-80-100-120

Description: Ceramic grit with added grinding aids on a stable polyester backing. Can be used both wet and dry. Ideal product for medium-heavy applications.

Please consult Cibo on sizes, qualities and grit.



WC44

CLOTH ABRASIVES

S/C

applications	backing	weight	grit type	coating	waterproof
	Cotton	X/W	S/C	-	●

Grit range: 280-320-400

Description: Silicon carbide on a waterproof "X" cotton backing. Suited for working glass and stone, both dry and wet. Can also be used to work non-ferrous metals, plastics, polyesters and rubber.

Please consult Cibo on sizes, qualities and grit.



CJ83

CLOTH ABRASIVES

S/C

applications	backing	weight	grit type	coating	waterproof
	Polyester-Cotton	J	S/C	-	-

Grit range: 80-100-120-150-180

Description: Silicon carbide on a flexible polyester cotton base. Ideal for working on aluminium, high quality alloys, polyesters and plastics.

Please consult Cibo on sizes, qualities and grit.



Tips & tricks: silicon carbide belts

Silicon carbide belts are, besides their applications for aluminium and non-ferrous metals, very often used to work stone. This is due to the fact that silicon carbide is the only grit type that is so pointy and therefore sufficiently sharp.

Cibo can manufacture customised belts for you: going from small abrasive sleeves to wide belts for automatic throughput machines. Contact us for advice or prices without any obligation.

● = available from stock

● = available in 5 working days

● = on request

> **Cloth belts**

S/C

CLOTH ABRASIVES



CJ91

applications	backing	weight	grit type	coating	waterproof
	Polyester-Cotton	J	S/C	-	-

Grit range: 240-320

Description: Silicon carbide on a flexible polyester cotton base. Ideal for working on non-ferrous metals, aluminium, high-quality alloys, porcelain, polyesters and plastics.

Please consult Cibo on sizes, qualities and grit.

S/C

CLOTH ABRASIVES



HC25

applications	backing	weight	grit type	coating	waterproof
	Polyester	H	S/C	-	

Grit range: 24-36-40-60-80-100-120-150-180-220

Description: Silicon carbide on a waterproof "H" polyester backing. Suited for working glass and stone, both dry and wet. Can also be used to work non-ferrous metals, aluminium, plastics, polyesters and rubber.

Please consult Cibo on sizes, qualities and grit.

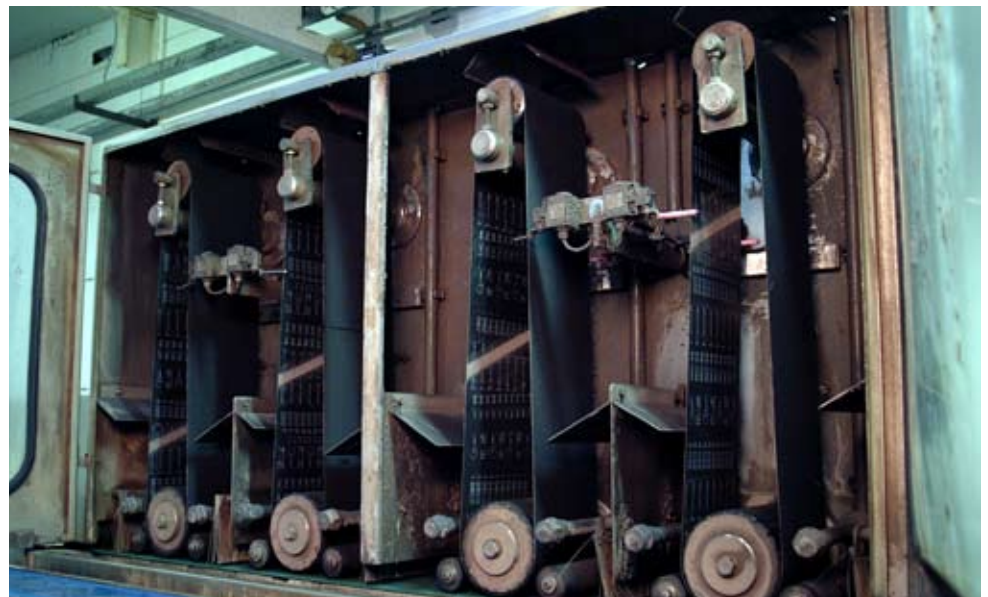

Cloth belts

237AA

CLOTH ABRASIVES

A/O TRIZACT™

applications	backing	weight	grit type	coating	waterproof
	Cotton	X	A/O Trizact™	-	-



Grit range: A160 (P120)-A100 (P220)-A80 (P240)-A65 (P280)-A45 (P400)-A30 (P600)-A16 (P1400)-A6 (P2000)

Description: This is a product of the Trizact™ family (3M). Trizact™ is an innovative grinding material produced with perfectly calibrated aluminium oxide grit in a pyramid shape. This three-dimensional grit of identical height ensure quick stock removal and an even and replicable finish without deep scratching or risk of burrs. This product has been especially developed for material that is difficult to work, such as stainless steel and exotic alloys, as used in aviation and space travel and in the medical sector. In addition, it has been used successfully in the finishing of copper, bronze, aluminium, composite materials and synthetic materials. The 237AA is not suited for use on titanium.

L x W	grit	code	stock	
293x100	A160 (P120)	237AA/160/293x100B	●	10
	A100 (P220)	237AA/100/293x100B	●	10
	A80 (P240)	237AA/80/293x100B	●	10
	A65 (P280)	237AA/65/293x100B	●	10
	A45 (P400)	237AA/45/293x100B	●	10
	A30 (P600)	237AA/30/293x100B	●	10
	A16 (P1400)	237AA/16/293x100B	●	10
	A6 (P2000)	237AA/6/293x100B	●	10
385x100	A160 (P120)	237AA/160/385x100B	●	10
	A100 (P220)	237AA/100/385x100B	●	10
	A80 (P240)	237AA/80/385x100B	●	10
	A65 (P280)	237AA/65/385x100B	●	10
	A45 (P400)	237AA/45/385x100B	●	10
	A30 (P600)	237AA/30/385x100B	●	10
	A16 (P1400)	237AA/16/385x100B	●	10
	A6 (P2000)	237AA/6/385x100B	●	10
675x40	A160 (P120)	237AA/160/675x40B	●	10
	A100 (P220)	237AA/100/675x40B	●	10
	A80 (P240)	237AA/80/675x40B	●	10
	A65 (P280)	237AA/65/675x40B	●	10
	A45 (P400)	237AA/45/675x40B	●	10
	A30 (P600)	237AA/30/675x40B	●	10
	A16 (P1400)	237AA/16/675x40B	●	10
	A6 (P2000)	237AA/6/675x40B	●	10

> Cloth belts

A/O TRIZACT™ CLOTH ABRASIVES



337DC					
applications	backing	weight	grit type	coating	waterproof
	Cotton	X	A/O Trizact™	-	-
Grit range: A300 (P80)-A160 (P120)-A100 (P220)-A65 (P280)-A45 (P400)					
Description: The properties of the quality of the 337DC Trizact™ are similar to those of the 237AA, but the 337DC has a higher stock removal capacity.					
L x W	grit	code		stock	
293x100	A300 (P80)	337DC/300/293x100B		●	10
	A160 (P120)	337DC/160/293x100B		●	10
	A100 (P220)	337DC/100/293x100B		●	10
	A65 (P280)	337DC/65/293x100B		●	10
	A45 (P400)	337DC/45/293x100B		●	10
385x100	A300 (P80)	337DC/300/385x100B		●	10
	A160 (P120)	337DC/160/385x100B		●	10
	A100 (P220)	337DC/100/385x100B		●	10
	A65 (P280)	337DC/65/385x100B		●	10
	A45 (P400)	337DC/45/385x100B		●	10
675x40	A300 (P80)	337DC/300/675x40B		●	10
	A160 (P120)	337DC/160/675x40B		●	10
	A100 (P220)	337DC/100/675x40B		●	10
	A65 (P280)	337DC/65/675x40B		●	10
	A45 (P400)	337DC/45/675x40B		●	10











CER. TRIZACT™ CLOTH ABRASIVES



953FA					
applications	backing	weight	grit type	coating	waterproof
	Polyester	H	CER. Trizact™	-	●
Grit range: A300 (P80)-A160 (P120)-A100 (P220)-A65 (P280)-A45 (P400)					
Description: This Trizact™ grade is made from a calibrated cubitron grit type on a polyester backing. This quality offers a much higher stock removal capacity than the 337DC and can also be used when wet.					
<i>Please consult Cibo on sizes, qualities and grit.</i>					

Trizact™ is a registered trademark of the 3M Company.

➤ Cloth belts

MFX					
applications	backing	weight	grit type	coating	waterproof
	Cotton	J	Calibrated A/O	-	
Grit range:	MFX180 (P600)-MFX240 (P1200)-MFX320 (P1500)-MFX400 (P3000)-MFX600 (P3500)-MFX800 (P4000)-MFX1200 (P6000)				
Description:	Micro-Mesh is a concept whereby extremely precisely calibrated grit crystals are bonded with a flexible glue on a supple cotton base. Due to the elastic positioning, this grit always comes in contact with the workpiece at a positive angle. This ensures a constant and even scratch depth. This ingeniously thought out design guarantees an extremely even, constant and precise finishing pattern.				
L x W	grit	code		stock	
675x40	MX180 (P600)	MFX/180/675x40TB			10
	MX240 (P1200)	MFX/240/675x40TB			10
	MX320 (P1500)	MFX/320/675x40TB			10
	MX400 (P3000)	MFX/400/675x40TB			10
	MX600 (P3500)	MFX/600/675x40TB			10
	MX800 (P4000)	MFX/800/675x40TB			10
	MX1200 (P6000)	MFX/1200/675x40TB			10

CLOTH ABRASIVES

CALIBRATED
A/O

(*) Micro-Mesh obtains the best results when a light water mist is used. Micro-Mesh is not suited for applications where excessive amounts of water are added.



Tips & Tricks: Steps to polish a 2B tube to a mirror shine with the Finitube

Requirements: a Finitube with belts and an adjustable angle grinder with a polishing wheel

- STEP 1: Finitube + 237AA/45/675x40B
- STEP 2: Finitube + 237AA/30/675x40B
- STEP 3: Finitube + MFX/240/675x40TB
- STEP 4: Finitube + MFX/320/675x40TB
- STEP 5: Adjustable angle grinder + FLM12550 (Flannel polishing wheel, see p. 371) + pink polishing paste



 = available from stock

 = available in 5 working days

 = on request

> Cloth belts

CORK

CLOTH ABRASIVES

W445



applications	backing	weight	grit type	coating	waterproof
	Polyester	Y	CORK	-	

Grit range: -

Description: Cork on a polyester backing. Specially designed for working glass borders. After water is added, a better finish is achieved and the life span of the belt is extended.

Please consult Cibo on sizes, qualities and grit.



Tips & tricks: belts

Choosing the correct grit type or grade pays off. Each application requires its own specific abrasive material. This is also the reason why the Cibo product range is so extensive. Our warehouse is chock-full of all kinds of different basic materials. Get advice from Cibo advisors to choose the correct abrasive belt.

Are you looking for a belt and you cannot find it in this catalogue? If so, please do not hesitate to contact us at +32 (0) 16 61 85 85, or send an email to info@cibo.be. Cibo can produce the belts very quickly for you, in the required grade, grit size and dimensions.



> Tex belts

A/O

TEX







A/O - OPEN BELTS WITH GRIP LOCK

applications		backing	weight	grit type	coating	waterproof
		Nylon web	-	A/O	-	
Grit range: A-Coarse - A-Medium - A-Fine - A-Very Fine STRONG - A-Very Fine SOFT - A-Very Fine SUPERSOFT						
Description: The nylon fibres are combined into a three-dimensional web structure using thermo-setting synthetic resin, and are available in various grit types with an aluminium oxide grit. The result is an elastic abrasive material with an open structure that is easy to use and provides an even and constant finish. The tex material does not affect the geometrical shape of the work pieces. A/O creates a good long-lasting finish at high speeds.						
L x W	grit	code			stock	
600x40	AF	FMGRT/AF/60040				10



> Tex belts

S/C - OPEN BELTS WITH GRIP LOCK

applications	backing	weight	grit type	coating	waterproof
	Nylon web	-	S/C	-	
Grit range: S-Medium - S-Fine - S-Very Fine - S-Ultra Fine 600 - S-Ultra Fine 1000 - S-Ultra Fine 1200					
Description: The nylon fibres are combined into a three-dimensional web structure using thermo-setting synthetic resin, and are available in various grit sizes with silicon carbide grit. The result is an elastic abrasive material with an open structure that is easy to use and provides an even and constant finish. The tex material does not affect the geometrical shape of the work pieces. In comparison with the A/O, S/C provides a finer, more even and matt texture. Primarily used to create a decorative finish.					
L x W	grit	code	stock		
600x40	SUF600	FMGRT/SUF/60040			10

TEX

S/C





Tips & tricks: Finishing closed tube constructions

Use open belts to finish your closed tube constructions.

Hook the belt around the tube, close the extremities with the supplied hook and loop lock and place the Finimaster's drive wheel in the belt. Then start the machine and apply an even structure along the entire tube construction. It can be this simple to give a perfect finish to your construction.

The Cibo range includes both cloth open belts (see p. 104) and tex open belts with grip lock.

 = available from stock

 = available in 5 working days

 = on request

Reinforced Tex-belts

Length of 297 to 457 mm

A/O

SURF. COND.

FE



applications	backing	weight	grit type	coating	waterproof
	Polyester + Nylon web	-	A/O	-	

Grit range: COARSE - MEDIUM - VERY FINE

Description: This is an open nylon web structure, permeated with aluminium oxide grit and anchored by a synthetic resin on a woven polyester structure. This quality is better able to cope with aggressive applications and has a long life span. The finish of the FE quality is less uniform than that of the RC quality.

L x W	grit	code	stock	
297x100	CO	FMVT/FE1/297x100	●	10
	ME	FMVT/FE2/297x100	●	10
	VF	FMVT/FE3/297x100	●	10
305x100	CO	FMVT/FE1/305x100	●	10
	ME	FMVT/FE2/305x100	●	10
	VF	FMVT/FE3/305x100	●	10
395x100	CO	VT/FE1/395x100TB	●	10
	ME	VT/FE2/395x100TB	●	10
	VF	VT/FE3/395x100TB	●	10
450x20	CO	VT/FE1/450x20TB	●	10
	ME	VT/FE2/450x20TB	●	10
	VF	VT/FE3/450x20TB	●	10
450x30	CO	VT/FE1/450x30TB	●	10
	ME	VT/FE2/450x30TB	●	10
	VF	VT/FE3/450x30TB	●	10
450x50	CO	VT/FE1/450x50TB	●	10
	ME	VT/FE2/450x50TB	●	10
	VF	VT/FE3/450x50TB	●	10
457x6	CO	VT/FE1/457x6TB	●	10
	ME	VT/FE2/457x6TB	●	10
	VF	VT/FE3/457x6TB	●	10
457x9	CO	VT/FE1/457x9TB	●	10
	ME	VT/FE2/457x9TB	●	10
	VF	VT/FE3/457x9TB	●	10



Length of 457 to 533 mm

FE

L x W	grit	code	stock	
457x13	CO	VT/FE1/457x13TB	●	10
	ME	VT/FE2/457x13TB	●	10
	VF	VT/FE3/457x13TB	●	10
457x19	CO	VT/FE1/457x19TB	●	10
	ME	VT/FE2/457x19TB	●	10
	VF	VT/FE3/457x19TB	●	10
463x13	CO	VT/FE1/463x13TB	●	10
	ME	VT/FE2/463x13TB	●	10
	VF	VT/FE3/463x13TB	●	10
463x19	CO	VT/FE1/463x19TB	●	10
	ME	VT/FE2/463x19TB	●	10
	VF	VT/FE3/463x19TB	●	10
520x6	CO	VT/FE1/520x6TB	●	10
	ME	VT/FE2/520x6TB	●	10
	VF	VT/FE3/520x6TB	●	10
520x13	CO	VT/FE1/520x13TB	●	10
	ME	VT/FE2/520x13TB	●	10
	VF	VT/FE3/520x13TB	●	10
520x16	CO	VT/FE1/520x16TB	●	10
	ME	VT/FE2/520x16TB	●	10
	VF	VT/FE3/520x16TB	●	10
520x20	CO	VT/FE1/520x20TB	●	10
	ME	VT/FE2/520x20TB	●	10
	VF	VT/FE3/520x20TB	●	10
520x30	CO	VT/FE1/520x30TB	●	10
	ME	VT/FE2/520x30TB	●	10
	VF	VT/FE3/520x30TB	●	10
533x9	CO	VT/FE1/533x9TB	●	10
	ME	VT/FE2/533x9TB	●	10
	VF	VT/FE3/533x9TB	●	10



● = available from stock

● = available in 5 working days

● = on request



>>

Length of 533 to 620 mm

FE









L x W	grit	code	stock	
533x13	CO	VT/FE1/533x13TB	●	10
	ME	VT/FE2/533x13TB	●	10
	VF	VT/FE3/533x13TB	●	10
610x6	CO	VT/FE1/610x6TB	●	10
	ME	VT/FE2/610x6TB	●	10
	VF	VT/FE3/610x6TB	●	10
610x13	CO	VT/FE1/610x13TB	●	10
	ME	VT/FE2/610x13TB	●	10
	VF	VT/FE3/610x13TB	●	10
620x40	CO	VT/FE1/620x40TB	●	10
	ME	VT/FE2/620x40TB	●	10
	VF	VT/FE3/620x40TB	●	10



The FE-grade is mainly used for short belts. These are used for applications where the edge durability is the most important.



➤ Reinforced Tex-belts





RC					
applications	backing	weight	grit type	coating	waterproof
	Polyester + Nylon web	–	A/O	–	
Grit range: COARSE - MEDIUM - VERY FINE					
Description: This is an open nylon web structure, permeated with aluminium oxide grit and anchored by a synthetic resin on a woven polyester structure. This material has a high initial cutting force, works perfectly at low pressure and provides a very constant and even finish. The RC is less edge resistant. Ideal for applications requiring a decorative finish.					
L x W	grit	code		stock	
675x40	CO	VT/RC1/675x40TB			10
	ME	VT/RC2/675x40TB			10
	VF	VT/RC3/675x40TB			10
2000x75	CO	VT/RC1/2000x75TB			10
	ME	VT/RC2/2000x75TB			10
	VF	VT/RC3/2000x75TB			10

SURF. COND.

A/O



The RC-grade is ideally suited for applications where the grade and evenness of the finish are the priority.

T00					
applications	backing	weight	grit type	coating	waterproof
	Polyester + Nylon web	–	–	–	
Grit range: No grit					
Description: This is an open nylon web structure, permeated with talc and anchored with a synthetic resin on a woven polyester structure. This quality has no abrasive properties and is specially designed to clean or polish using polishing pastes.					
L x W	grit	code		stock	
675x40	T00	VT/T00/675x40TB			10

SURF. COND.

–



Please consult Cibo on sizes, qualities and grit.

 = available from stock

 = available in 5 working days

 = on request

DISCS

● Overview table	130
● Cutting shapes	144
○ With perforations	144
○ Pre-perforated	145
○ Without perforations/ centre holes	146
○ With centre holes	147
○ With centre holes and central slots	148
● Film	150
○ Grip discs	150
○ Aluminium oxide	150
● Paper	152
○ Grip discs	152
○ Aluminium oxide	152
○ Zirconium oxide	158
○ Silicon carbide	160
○ Double-sided discs	164
○ Silicon carbide	164
● Mesh	165
○ Discs	165
○ Silicon carbide	165
● Cloth	166
○ Grip discs	166
○ Zirconium oxide	166
○ Ceramic	166
○ Finishing Kit	167
○ Trizact™	168
○ Micro-Mesh	170
● Tex	171
○ Grip discs	171
○ Aluminium oxide	171
○ Silicon carbide	172
○ CP	173
○ No grit	174
○ Discs without centre holes	174
○ Aluminium oxide	174
○ Silicon carbide	175
○ Discs with centre holes	176
○ Aluminium oxide	176
○ Silicon carbide	177
○ CP	178
○ Talc	179
○ Silicon carbide (CSD)	179
● Floorpads	180
● Reinforced Tex	181
○ Discs without centre holes	181
○ Aluminium oxide	181
○ Discs with centre holes	182
○ Aluminium oxide	182
○ Abrasive stars	183
○ Aluminium oxide	183
○ Fibre discs	184
○ Aluminium oxide	184
○ Grip discs	184
○ T00	184
● Unitized	185
○ Grip discs	185
○ Aluminium oxide - Silicon carbide	185



DISCS



OVERVIEW

Cibo has an enormous range of basic materials available. From each of these abrasive materials discs can be cut. The sizes of the disc and the number of holes obviously depend on the machine to which you wish to attach the disc. This machine also determines whether the disc should have a velcro backing, or whether the disc is attached with a screw, or spray glue is used to attach the disc, etc.

To make it easy to select one of the abrasive materials, you will find an overview of the various materials and applications on the following pages. From page 144 onwards, you will also find an overview of the main cutting forms in our range.

Application		Type	Backing	Weight	Type of grit	Top Coating	Waterproof	Maximum width	Grit type
Metal 	Cloth	TZ59	Cotton	X	ZIRC.	-	-	1420	36-40-50-60-80-100-120
	Tex	A/O	Nylon web	-	A/O	-	💧	1500	A-Coarse - A-Medium - A-Fine - A-Very Fine STRONG - A-Very Fine SOFT - A-Very Fine SUPERSOFT
		CP		-	A/O CP	-	💧	610	CP
		CSD		-	S/C	-	💧	610	EXTRA COARSE
Stainless steel 	Paper	KP950F	Paper	F	ZIRC.	-	-	1450	40-60-80-100-120-150-180-220
	Cloth	TZ59	Cotton	X	ZIRC.	-	-	1420	36-40-50-60-80-100-120
		777F	Polyester	H	CER.	●	💧	1320	40-60-80-100-120
		237AA	Cotton	X	A/O Trizact™	-	-	660	A160 (P120)-A100 (P220)-A80 (P240)-A65 (P280)-A45 (P400)-A30 (P600)-A16 (P1400)-A6 (P2000)
		337DC	Cotton	X	A/O Trizact™	-	-	660	A300 (P80)-A160 (P120)-A100 (P220)-A65 (P280)-A45 (P400)

Trizact™ is a registered trademark of the 3M Company.

➤ USE OF THE TABLE

Simply have a look at the material you wish to work on, select one of the abrasive materials recommended by Cibo, and you will be referred to the page where you can find the disc you want. On this page you will also find the most frequently used grit types and cutting forms.

However, customisation is also the norm at Cibo. If you require a cutting shape that is not displayed in the table, please do not hesitate to contact Cibo. We can manufacture the discs for you in almost no time.



Take note: this table only shows the qualities that Cibo feels are the most suitable for a specific application. Should you require a broader overview, please return to the comprehensive overview of the available basic materials on page 58. Cibo can also very quickly cut discs from this material for you.

Properties	Page
High-quality aluminium/zirconium oxide on a highly resistant "X" backing. Ideal for professional applications on stainless steel, aluminium, metal, non-ferrous metals and hard wood.	166
The nylon fibres are combined into a three-dimensional web structure using thermo-setting synthetic resin, and are available in various grit types with an aluminium oxide grit. The result is an elastic abrasive material with an open structure that is easy to use and provides an even and constant finish. The tex material does not affect the geometrical shape of the work pieces. A/O creates a good long-lasting finish at high speeds.	from 171
The nylon fibres are combined into a three-dimensional web structure using thermo-setting synthetic resin with an aluminium oxide grit type. The result is an elastic abrasive material with an open structure that is easy to use and provides an even and constant finish. The tex material does not affect the geometrical shape of the work pieces. CP has an increased grinding capacity at higher speeds. This material provides the brush structure with a slightly glossy effect.	from 173
CSD material is made from very hard, abrasion-resistant nylon fibres with a very open structure. The nylon fibres are permeated with synthetic resin and very sharp grit.	179
Zirconium oxide grain on an "F" paper base. This product is ideally suited for grinding very hard and dry woods because of the extremely abrasive-resistant zirconium oxide grit. The KP950F is also highly efficient when using stainless steel.	158
High-quality aluminium/zirconium oxide on a highly resistant "X" backing. Ideal for professional applications on stainless steel, aluminium, metal, non-ferrous metals and hard wood.	166
Ceramic grit with added grinding aids on a stable polyester backing. Can be used both wet and dry. Ideal product for medium-heavy applications.	166
This is a product of the Trizact™ family (3M). Trizact™ is an innovative grinding material produced with perfectly calibrated aluminium oxide grit in a pyramid shape. This three-dimensional grit of identical height ensure quick stock removal and an even and replicable finish without deep scratching or risk of burrs. This product has been especially developed for material that is difficult to work, such as stainless steel and exotic alloys, as used in aviation and space travel and in the medical sector. In addition, it has been used successfully in the finishing of copper, bronze, aluminium, composite materials and synthetic materials. The 237AA is not suited for use on titanium.	168
The properties of the 337DC Trizact™ grade are similar to those of the 237AA, but the 337DC has a higher stock removal capacity.	170

Application		Type	Backing	Weight	Type of grit	Top Coating	Waterproof	Maximum width	Grit type
Stainless steel 	Cloth	MFR	Cotton	F	Calibrated A/O	-	☑*	500	MFR1500 (P600)-MFR1800 (P1200)-MFR2400 (P1500)-MFR3200 (P2500)-MFR3600 (P3000)-MFR4000 (P4000)-MFR6000 (P5000)-MFR8000 (P6000)-MFR12000 (P8000)
		MFX	Cotton	J	Calibrated A/O	-	☑*	500	MFX180 (P600)-MFX240 (P1200)-MFX320 (P1500)-MFX400 (P3000)-MFX600 (P3500)-MFX800 (P4000)-MFX1200 (P6000)
	Tex	A/O	Nylon web	-	A/O	-	☑	1500	A-Coarse - A-Medium - A-Fine - A-Very Fine STRONG - A-Very Fine SOFT - A-Very Fine SUPERSOFT
		S/C		-	S/C	-	☑	1500	S-Medium - S-Fine - S-Very Fine - S-Ultra Fine 600 - S-Ultra Fine 1000 - S-Ultra Fine 1200
		CP		-	A/O CP	-	☑	610	CP
		CSD		-	S/C	-	☑	610	EXTRA COARSE
	Reinforced Tex	FE	Polyester + Nylon web	-	A/O	-	☑	1250	COARSE - MEDIUM - VERY FINE
		RC		-	A/O	-	☑	1250	COARSE - MEDIUM - VERY FINE
		T00		-	-	-	☑	1270	No grit

(*) Micro-mesh achieves the best results provided a light mist is used. The use of an excessive amount of water is not recommended with Micro-mesh.



Properties	Page
Micro-Mesh is a concept whereby extremely precisely calibrated grit crystals are bonded with a flexible glue on a supple cotton base. Due to the elastic positioning, this grit always comes in contact with the workpiece at a positive angle. This ensures a constant and even scratch depth. This ingeniously thought out design guarantees an extremely even, constant and precise finishing pattern.	170
Micro-Mesh is a concept whereby extremely precisely calibrated grit crystals are bonded with a flexible glue on a supple cotton base. Due to the elastic positioning, this grit always comes in contact with the workpiece at a positive angle. This ensures a constant and even scratch depth. This ingeniously thought out design guarantees an extremely even, constant and precise finishing pattern.	170
The nylon fibres are combined into a three-dimensional web structure using thermo-setting synthetic resin, and are available in various grit types with an aluminium oxide grit. The result is an elastic abrasive material with an open structure that is easy to use and provides an even and constant finish. The tex material does not affect the geometrical shape of the work pieces. A/O creates a good long-lasting finish at high speeds.	from 171
The nylon fibres are combined into a three-dimensional web structure using thermo-setting synthetic resin, and are available in various grit sizes with silicon carbide grit. The result is an elastic abrasive material with an open structure that is easy to use and provides an even and constant finish. The tex material does not affect the geometrical shape of the work pieces. In comparison with the A/O, S/C provides a finer, more even and matt texture. Primarily used to create a decorative finish.	from 172
The nylon fibres are combined into a three-dimensional web structure using thermo-setting synthetic resin with an aluminium oxide grit type. The result is an elastic abrasive material with an open structure that is easy to use and provides an even and constant finish. The tex material does not affect the geometrical shape of the work pieces. CP has an increased grinding capacity at higher speeds. This material provides the brush structure with a slightly glossy effect.	from 173
CSD material is made from very hard, abrasion-resistant nylon fibres with a very open structure. The nylon fibres are permeated with synthetic resin and very sharp grit.	179
This is an open nylon web structure, permeated with aluminium oxide grit and anchored by a synthetic resin on a woven polyester structure. This quality is better able to cope with aggressive applications and has a longer life span. The finish of the FE quality is less uniform than that of the RC quality.	from 181
This is an open nylon web structure, permeated with aluminium oxide grit and anchored by a synthetic resin on a woven polyester structure. This material has a high initial cutting force, works perfectly at low pressure and provides a very constant and even finish. The RC is less edge resistant. Ideal for applications requiring a decorative finish.	from 181
This is an open nylon web structure, permeated with talc and anchored with a synthetic resin on a woven polyester structure. This quality has no abrasive properties and is specially designed to clean or polish using polishing pastes.	184

Application		Type	Backing	Weight	Type of grit	Top Coating	Waterproof	Maximum width	Grit type
High-quality alloys 	Cloth	777F	Polyester	H	CER.	●	💧	1320	40-60-80-100-120
		237AA	Cotton	X	A/O Trizact™	–	–	660	A160 (P120)-A100 (P220)-A80 (P240)-A65 (P280)-A45 (P400)-A30 (P600)-A16 (P1400)-A6 (P2000)
		337DC	Cotton	X	A/O Trizact™	–	–	660	A300 (P80)-A160 (P120)-A100 (P220)-A65 (P280)-A45 (P400)
		MFR	Cotton	F	Calibrated A/O	–	💧*	500	MFR1500 (P600)-MFR1800 (P1200)-MFR2400 (P1500)-MFR3200 (P2500)-MFR3600 (P3000)-MFR4000 (P4000)-MFR6000 (P5000)-MFR8000 (P6000)-MFR12000 (P8000)
		MFX	Cotton	J	Calibrated A/O	–	💧*	500	MFX180 (P600)-MFX240 (P1200)-MFX320 (P1500)-MFX400 (P3000)-MFX600 (P3500)-MFX800 (P4000)-MFX1200 (P6000)
	Tex	S/C	Nylon web	–	S/C	–	💧	1500	S-Medium - S-Fine - S-Very Fine - S-Ultra Fine 600 - S-Ultra Fine 1000 - S-Ultra Fine 1200
Non-ferrous 	Cloth	TZ59	Cotton	X	ZIRC.	–	–	1420	36-40-50-60-80-100-120
		777F	Polyester	H	CER.	●	💧	1320	40-60-80-100-120
		237AA	Cotton	X	A/O Trizact™	–	–	660	A160 (P120)-A100 (P220)-A80 (P240)-A65 (P280)-A45 (P400)-A30 (P600)-A16 (P1400)-A6 (P2000)
		337DC	Cotton	X	A/O Trizact™	–	–	660	A300 (P80)-A160 (P120)-A100 (P220)-A65 (P280)-A45 (P400)
	Tex	S/C	Nylon web	–	S/C	–	💧	1500	S-Medium - S-Fine - S-Very Fine - S-Ultra Fine 600 - S-Ultra Fine 1000 - S-Ultra Fine 1200

Trizact™ is a registered trademark of the 3M Company.



(*) Micro-mesh achieves the best results provided a light mist is used. The use of an excessive amount of water is not recommended with Micro-mesh.

Properties	Page
Ceramic grit with added grinding aids on a stable polyester backing. Can be used both wet and dry. Ideal product for medium-heavy applications.	166
This is a product of the Trizact™ family (3M). Trizact™ is an innovative grinding material produced with perfectly calibrated aluminium oxide grit in a pyramid shape. This three-dimensional grit of identical height ensure quick stock removal and an even and replicable finish without deep scratching or risk of burrs. This product has been especially developed for material that is difficult to work, such as stainless steel and exotic alloys, as used in aviation and space travel and in the medical sector. In addition, it has been used successfully in the finishing of copper, bronze, aluminium, composite materials and synthetic materials. The 237AA is not suited for use on titanium.	168
The properties of the 337DC Trizact™ grade are similar to those of the 237AA, but the 337DC has a higher stock removal capacity.	170
Micro-Mesh is a concept whereby extremely precisely calibrated grit crystals are bonded with a flexible glue on a supple cotton base. Due to the elastic positioning, this grit always comes in contact with the workpiece at a positive angle. This ensures a constant and even scratch depth. This ingeniously thought out design guarantees an extremely even, constant and precise finishing pattern.	170
Micro-Mesh is a concept whereby extremely precisely calibrated grit crystals are bonded with a flexible glue on a supple cotton base. Due to the elastic positioning, this grit always comes in contact with the workpiece at a positive angle. This ensures a constant and even scratch depth. This ingeniously thought out design guarantees an extremely even, constant and precise finishing pattern.	170
The nylon fibres are combined into a three-dimensional web structure using thermo-setting synthetic resin, and are available in various grit sizes with silicon carbide grit. The result is an elastic abrasive material with an open structure that is easy to use and provides an even and constant finish. The tex material does not affect the geometrical shape of the work pieces. In comparison with the A/O, S/C provides a finer, more even and matt texture. Primarily used to create a decorative finish.	from 172
High-quality aluminium/zirconium oxide on a highly resistant "X" backing. Ideal for professional applications on stainless steel, aluminium, metal, non-ferrous metals and hard wood.	166
Ceramic grit with added grinding aids on a stable polyester backing. Can be used both wet and dry. Ideal product for medium-heavy applications.	166
This is a product of the Trizact™ family (3M). Trizact™ is an innovative grinding material produced with perfectly calibrated aluminium oxide grit in a pyramid shape. This three-dimensional grit of identical height ensure quick stock removal and an even and replicable finish without deep scratching or risk of burrs. This product has been especially developed for material that is difficult to work, such as stainless steel and exotic alloys, as used in aviation and space travel and in the medical sector. In addition, it has been used successfully in the finishing of copper, bronze, aluminium, composite materials and synthetic materials. The 237AA is not suited for use on titanium.	168
The properties of the 337DC Trizact™ grade are similar to those of the 237AA, but the 337DC has a higher stock removal capacity.	170
The nylon fibres are combined into a three-dimensional web structure using thermo-setting synthetic resin, and are available in various grit sizes with silicon carbide grit. The result is an elastic abrasive material with an open structure that is easy to use and provides an even and constant finish. The tex material does not affect the geometrical shape of the work pieces. In comparison with the A/O, S/C provides a finer, more even and matt texture. Primarily used to create a decorative finish.	from 172















Application		Type	Backing	Weight	Type of grit	Top Coating	Waterproof	Maximum width	Grit type
Non-ferrous 	Reinforced Tex	FE		-	A/O	-		1250	COARSE - MEDIUM - VERY FINE
		RC	Polyester + Nylon web	-	A/O	-		1250	COARSE - MEDIUM - VERY FINE
		T00		-	-	-		1270	No grit
aluminium 	Cloth	TZ59	Cotton	X	ZIRC.	-	-	1420	36-40-50-60-80-100-120
		237AA	Cotton	X	A/O Trizact™	-	-	660	A160 (P120)-A100 (P220)-A80 (P240)-A65 (P280)-A45 (P400)-A30 (P600)-A16 (P1400)-A6 (P2000)
		337DC	Cotton	X	A/O Trizact™	-	-	660	A300 (P80)-A160 (P120)-A100 (P220)-A65 (P280)-A45 (P400)
	Tex	S/C	Nylon web	-	S/C	-		1500	S-Medium - S-Fine - S-Very Fine - S-Ultra Fine 600 - S-Ultra Fine 1000 - S-Ultra Fine 1200
	Reinforced Tex	FE		-	A/O	-		1250	COARSE - MEDIUM - VERY FINE
		RC	Polyester + Nylon web	-	A/O	-		1250	COARSE - MEDIUM - VERY FINE
		T00		-	-	-		1270	No grit
Hard wood 	Paper	KP947F	Paper	F	A/O	-	-	1450	240-280-320-400
		KP949FO	Paper	F	A/O	-	-	1450	40-60-80-100-120-150-180-220
		KP950F	Paper	F	ZIRC.	-	-	1450	40-60-80-100-120-150-180-220

Trizact™ is a registered trademark of the 3M Company.

Properties	Page
This is an open nylon web structure, permeated with aluminium oxide grit and anchored by a synthetic resin on a woven polyester structure. This quality is better able to cope with aggressive applications and has a longer life span. The finish of the FE quality is less uniform than that of the RC quality.	from 181
This is an open nylon web structure, permeated with aluminium oxide grit and anchored by a synthetic resin on a woven polyester structure. This material has a high initial cutting force, works perfectly at low pressure and provides a very constant and even finish. The RC is less edge resistant. Ideal for applications requiring a decorative finish.	from 181
This is an open nylon web structure, permeated with talc and anchored with a synthetic resin on a woven polyester structure. This quality has no abrasive properties and is specially designed to clean or polish using polishing pastes.	184
High-quality aluminium/zirconium oxide on a highly resistant "X" backing. Ideal for professional applications on stainless steel, aluminium, metal, non-ferrous metals and hard wood.	166
This is a product of the Trizact™ family (3M). Trizact™ is an innovative grinding material produced with perfectly calibrated aluminium oxide grit in a pyramid shape. This three-dimensional grit of identical height ensure quick stock removal and an even and replicable finish without deep scratching or risk of burrs. This product has been especially developed for material that is difficult to work, such as stainless steel and exotic alloys, as used in aviation and space travel and in the medical sector. In addition, it has been used successfully in the finishing of copper, bronze, aluminium, composite materials and synthetic materials. The 237AA is not suited for use on titanium.	168
The properties of the 337DC Trizact™ grade are similar to those of the 237AA, but the 337DC has a higher stock removal capacity.	170
The nylon fibres are combined into a three-dimensional web structure using thermo-setting synthetic resin, and are available in various grit sizes with silicon carbide grit. The result is an elastic abrasive material with an open structure that is easy to use and provides an even and constant finish. The tex material does not affect the geometrical shape of the work pieces. In comparison with the A/O, S/C provides a finer, more even and matt texture. Primarily used to create a decorative finish.	from 172
This is an open nylon web structure, permeated with aluminium oxide grit and anchored by a synthetic resin on a woven polyester structure. This quality is better able to cope with aggressive applications and has a longer life span. The finish of the FE quality is less uniform than that of the RC quality.	from 181
This is an open nylon web structure, permeated with aluminium oxide grit and anchored by a synthetic resin on a woven polyester structure. This material has a high initial cutting force, works perfectly at low pressure and provides a very constant and even finish. The RC is less edge resistant. Ideal for applications requiring a decorative finish.	from 181
This is an open nylon web structure, permeated with talc and anchored with a synthetic resin on a woven polyester structure. This quality has no abrasive properties and is specially designed to clean or polish using polishing pastes.	184
Antistatic, closed coated aluminium oxide on a very strong "F" paper base. The antistatic property ensures the easy removal of dust. The KP947F is a product that can be used for various purposes. Perfect grade for both dry and hard woods as well as for those of a softer quality with a higher level of resin.	155
Antistatic, semi-open coated aluminium oxide on a very strong "F" paper base. The antistatic property ensures the easy removal of dust. The KP949FO is a product that can be used for various purposes. Perfect grade for both dry and hard woods as well as for those of a softer quality with a higher level of resin.	156
Zirconium oxide grain on an "F" paper base. This product is ideally suited for grinding very hard and dry woods because of the extremely abrasive-resistant zirconium oxide grit. The KP950F is also highly efficient when using stainless steel.	158













Application		Type	Backing	Weight	Type of grit	Top Coating	Waterproof	Maximum width	Grit type
Hard wood 	Paper	SP706F	Paper	F	S/C	–	–	1450	Grip: 24-36-40-60-80-100-120-220-320-400-500-600-800-1000-1200 Without grip: 24-36-40-50-60-80-100-120-150-180-220-240-280-320-400-500-600-800-1000-1200
		LKE22	Combina-tion	–	S/C	–	–	1250	16-20
	Cloth	TZ59	Cotton	X	ZIRC.	–	–	1420	36-40-50-60-80-100-120
	Tex	A/O	Nylon web	–	A/O	–	💧	1500	A-Coarse - A-Medium - A-Fine - A-Very Fine STRONG - A-Very Fine SOFT - A-Very Fine SUPERSOFT
Soft wood 	Paper	SA331	Film	–	A/O	●	💧	1380	40-60-80-100-120-150-180-220-320-400-600-800-1200
		CA330	Paper	C	A/O	●	–	1380	60-80-100-120-150-180-220-240-320-400-500-600
		KP947F	Paper	F	A/O	–	–	1450	240-280-320-400
		KP949FO	Paper	F	A/O	–	–	1450	40-60-80-100-120-150-180-220
		SP706F	Paper	F	S/C	–	–	1450	Grip: 24-36-40-60-80-100-120-220-320-400-500-600-800-1000-1200 Without grip: 24-36-40-50-60-80-100-120-150-180-220-240-280-320-400-500-600-800-1000-1200
		LKE22	Combina-tion	–	S/C	–	–	1250	16-20

Properties	Page
Antistatic silicon carbide grit on a very strong "F" base. Ideally suited for use in sanding wooden floors and parquet.	160
Combination abrasive material. A heavy F paper reinforced with a light fabric and provided with a very open silicon carbide grit structure. Primarily for use in sanding old and dirty wooden floors and parquet. Also suitable for removing old paint, glue and varnish layers or carpet remains.	163
High-quality aluminium/zirconium oxide on a highly resistant "X" backing. Ideal for professional applications on stainless steel, aluminium, metal, non-ferrous metals and hard wood.	166
The nylon fibres are combined into a three-dimensional web structure using thermo-setting synthetic resin, and are available in various grit types with an aluminium oxide grit. The result is an elastic abrasive material with an open structure that is easy to use and provides an even and constant finish. The tex material does not affect the geometrical shape of the work pieces. A/O creates a good long-lasting finish at high speeds.	from 171
Open coated aluminium oxide grit with an active abrasive ingredient on a film backing. Extremely tear-resistant. Does not clog up, long life span, extremely large grit size range. Can be used for many purposes, especially with more intensive grinding operations. Ideal for finishing of soft wood types and car repair, paints, lacquers and varnishes. Used both wet and dry.	150
Open coated aluminium oxide with grinding aid on flexible "C" paper. Very pliable and flexible, does not clog, adapts easily to the workpiece and guarantees a beautiful, even finish. Ideal for grinding primary coats, primers, sealers, lacquers, paint, varnish, filler and wood.	152
Antistatic, closed coated aluminium oxide on a very strong "F" paper base. The antistatic property ensures the easy removal of dust. The KP947F is a product that can be used for various purposes. Perfect grade for both dry and hard woods as well as for those of a softer quality with a higher level of resin.	155
Antistatic, semi-open coated aluminium oxide on a very strong "F" paper base. The antistatic property ensures the easy removal of dust. The KP949FO is a product that can be used for various purposes. Perfect grade for both dry and hard woods as well as for those of a softer quality with a higher level of resin.	156
Antistatic silicon carbide grit on a very strong "F" base. Ideally suited for use in sanding wooden floors and parquet.	160
Combination abrasive material. A heavy F paper reinforced with a light fabric and provided with a very open silicon carbide grit structure. Primarily for use in sanding old and dirty wooden floors and parquet. Also suitable for removing old paint, glue and varnish layers or carpet remains.	163

Application		Type	Backing	Weight	Type of grit	Top Coating	Waterproof	Maximum width	Grit type
Soft wood 	Cloth	QNSH	Mesh	–	S/C	–		910	40-60-80-100-120-150-180-220-320-400-600
	Tex	A/O	Nylon web	–	A/O	–		1500	A-Coarse - A-Medium - A-Fine - A-Very Fine STRONG - A-Very Fine SOFT - A-Very Fine SUPERSOFT
Glass & stone 	Paper	SP706F	Paper	F	S/C	–	–	1450	Grip: 24-36-40-60-80-100-120-220-320-400-500-600-800-1000-1200 Without grip: 24-36-40-50-60-80-100-120-150-180-220-240-280-320-400-500-600-800-1000-1200
	Tex	00	Nylon web	–	Talc	–		1500	No grit
Plastics & Rubber 	Cloth	MFR	Cotton	F	Calibrated A/O	–		500	MFR1500 (P600)-MFR1800 (P1200)-MFR2400 (P1500)-MFR3200 (P2500)-MFR3600 (P3000)-MFR4000 (P4000)-MFR6000 (P5000)-MFR8000 (P6000)-MFR12000 (P8000)
		MFX	Cotton	J	Calibrated A/O	–		500	MFX180 (P600)-MFX240 (P1200)-MFX320 (P1500)-MFX400 (P3000)-MFX600 (P3500)-MFX800 (P4000)-MFX1200 (P6000)
	Tex	S/C	Nylon web	–	S/C	–		1500	S-Medium - S-Fine - S-Very Fine - S-Ultra Fine 600 - S-Ultra Fine 1000 - S-Ultra Fine 1200
		CSD		–	S/C	–		610	EXTRA COARSE
Car repair 	Paper	SA331	Film	–	A/O			1380	40-60-80-100-120-150-180-220-320-400-600-800-1200
		CA330	Paper	C	A/O		–	1380	60-80-100-120-150-180-220-240-320-400-500-600
	Cloth	QNSH	Mesh	–	S/C	–		910	40-60-80-100-120-150-180-220-320-400-600

(*) Micro-mesh achieves the best results provided a light mist is used. The use of an excessive amount of water is not recommended with Micro-mesh.

Properties	Page
Open polyester web structure to which grits are anchored on both sides.	165
The nylon fibres are combined into a three-dimensional web structure using thermo-setting synthetic resin, and are available in various grit types with an aluminium oxide grit. The result is an elastic abrasive material with an open structure that is easy to use and provides an even and constant finish. The tex material does not affect the geometrical shape of the work pieces. A/O creates a good long-lasting finish at high speeds.	from 171
Antistatic silicon carbide grit on a very strong "F" base. Ideally suited for use in sanding wooden floors and parquet.	160
With the TEX 00, the nylon fibres are combined into a three-dimensional web structure using thermo-setting synthetic resin without abrasive grit. This material does not scratch and is ideally suited for cleaning.	from 174
Micro-Mesh is a concept whereby extremely precisely calibrated grit crystals are bonded with a flexible glue on a supple cotton base. Due to the elastic positioning, this grit always comes in contact with the workpiece at a positive angle. This ensures a constant and even scratch depth. This ingeniously thought out design guarantees an extremely even, constant and precise finishing pattern.	170
Micro-Mesh is a concept whereby extremely precisely calibrated grit crystals are bonded with a flexible glue on a supple cotton base. Due to the elastic positioning, this grit always comes in contact with the workpiece at a positive angle. This ensures a constant and even scratch depth. This ingeniously thought out design guarantees an extremely even, constant and precise finishing pattern.	170
The nylon fibres are combined into a three-dimensional web structure using thermo-setting synthetic resin, and are available in various grit sizes with silicon carbide grit. The result is an elastic abrasive material with an open structure that is easy to use and provides an even and constant finish. The tex material does not affect the geometrical shape of the work pieces. In comparison with the A/O, S/C provides a finer, more even and matt texture. Primarily used to create a decorative finish.	from 172
CSD material is made from very hard, abrasion-resistant nylon fibres with a very open structure. The nylon fibres are permeated with synthetic resin and very sharp grit.	179
Open coated aluminium oxide grit with an active abrasive ingredient on a film backing. Extremely tear-resistant. Does not clog up, long life span, extremely large grit size range. Can be used for many purposes, especially with more intensive grinding operations. Ideal for finishing of soft wood types and car repair, paints, lacquers and varnishes. Used both wet and dry.	150
Open coated aluminium oxide with grinding aid on flexible "C" paper. Very pliable and flexible, does not clog, adapts easily to the workpiece and guarantees a beautiful, even finish. Ideal for grinding primary coats, primers, sealers, lacquers, paint, varnish, filler and wood.	152
Open polyester web structure to which grits are anchored on both sides.	165

Application		Type	Backing	Weight	Type of grit	Top Coating	Waterproof	Maximum width	Grit type
Car repair 	Tex	A/O	Nylon web	-	A/O	-		1500	A-Coarse - A-Medium - A-Fine - A-Very Fine STRONG - A-Very Fine SOFT - A-Very Fine SUPERSOFT
		S/C		-	S/C	-		1500	S-Medium - S-Fine - S-Very Fine - S-Ultra Fine 600 - S-Ultra Fine 1000 - S-Ultra Fine 1200
		00		-	Talc	-		1500	No grit
		CSD		-	S/C	-		610	EXTRA COARSE
	Reinforced Tex	FE	Polyester + Nylon web	-	A/O	-		1250	COARSE - MEDIUM - VERY FINE
Lacquer & varnish 	Paper	SA331	Film	-	A/O			1380	40-60-80-100-120-150-180-220-320-400-600-800-1200
		CA330	Paper	C	A/O		-	1380	60-80-100-120-150-180-220-240-320-400-500-600
	Tex	A/O	Nylon web	-	A/O	-		1500	A-Coarse - A-Medium - A-Fine - A-Very Fine STRONG - A-Very Fine SOFT - A-Very Fine SUPERSOFT
		S/C		-	S/C	-		1500	S-Medium - S-Fine - S-Very Fine - S-Ultra Fine 600 - S-Ultra Fine 1000 - S-Ultra Fine 1200
		00		-	Talc	-		1500	No grit

Properties	Page
The nylon fibres are combined into a three-dimensional web structure using thermo-setting synthetic resin, and are available in various grit types with an aluminium oxide grit. The result is an elastic abrasive material with an open structure that is easy to use and provides an even and constant finish. The tex material does not affect the geometrical shape of the work pieces. A/O creates a good long-lasting finish at high speeds.	from 171
The nylon fibres are combined into a three-dimensional web structure using thermo-setting synthetic resin, and are available in various grit sizes with silicon carbide grit. The result is an elastic abrasive material with an open structure that is easy to use and provides an even and constant finish. The tex material does not affect the geometrical shape of the work pieces. In comparison with the A/O, S/C provides a finer, more even and matt texture. Primarily used to create a decorative finish.	from 172
With the TEX 00, the nylon fibres are combined into a three-dimensional web structure using thermo-setting synthetic resin without abrasive grit. This material does not scratch and is ideally suited for cleaning.	from 174
CSD material is made from very hard, abrasion-resistant nylon fibres with a very open structure. The nylon fibres are permeated with synthetic resin and very sharp grit.	179
This is an open nylon web structure, permeated with aluminium oxide grit and anchored by a synthetic resin on a woven polyester structure. This quality is better able to cope with aggressive applications and has a longer life span. The finish of the FE quality is less uniform than that of the RC quality.	from 181
Open coated aluminium oxide grit with an active abrasive ingredient on a film backing. Extremely tear-resistant. Does not clog up, long life span, extremely large grit size range. Can be used for many purposes, especially with more intensive grinding operations. Ideal for finishing of soft wood types and car repair, paints, lacquers and varnishes. Used both wet and dry.	150
Open coated aluminium oxide with grinding aid on flexible "C" paper. Very pliable and flexible, does not clog, adapts easily to the workpiece and guarantees a beautiful, even finish. Ideal for grinding primary coats, primers, sealers, lacquers, paint, varnish, filler and wood.	152
The nylon fibres are combined into a three-dimensional web structure using thermo-setting synthetic resin, and are available in various grit types with an aluminium oxide grit. The result is an elastic abrasive material with an open structure that is easy to use and provides an even and constant finish. The tex material does not affect the geometrical shape of the work pieces. A/O creates a good long-lasting finish at high speeds.	from 171
The nylon fibres are combined into a three-dimensional web structure using thermo-setting synthetic resin, and are available in various grit sizes with silicon carbide grit. The result is an elastic abrasive material with an open structure that is easy to use and provides an even and constant finish. The tex material does not affect the geometrical shape of the work pieces. In comparison with the A/O, S/C provides a finer, more even and matt texture. Primarily used to create a decorative finish.	from 172
With the TEX 00, the nylon fibres are combined into a three-dimensional web structure using thermo-setting synthetic resin without abrasive grit. This material does not scratch and is ideally suited for cleaning.	from 174

OVERVIEW OF MAIN CUTTING SHAPES

The cutting shape of the discs varies, depending on the machine to which you want to attach the discs. Certain machines need a lot of holes punched into the abrasive discs, while others do not require any at all. Some of them have a diameter of 115 mm, others have a diameter of 600 mm. To simplify your selection, you will find on the following pages an overview of the main cutting forms that are part of Cibo's standard range.

Remember: customisation is the norm at Cibo.







The parameters, used as the basis for the division are:

- discs with perforations
- pre-perforated discs
- discs without holes or centre holes
- discs with centre holes
- discs with centre holes and central sleeves

Are you having trouble determining the correct cutting form? If so, please contact Cibo at +32 (0) 16 61 85 85 or via info@cibo.be -- we would be happy to help you!

> Discs with perforations

DISCS WITH PERFORATIONS

shape	diameter	holes	code
	Ø 81	6	SP11
	Ø 115	8	SP01
	Ø 125	8	SP02
	Ø 125	8+1	SP12
	Ø 125	8+4+1	SP14
	Ø 150	6	SP03





shape	diameter	holes	code
	Ø 150	6+1	SP13
	Ø 150	8 I	SP04
	Ø 150	8E	SP10
	Ø 150	8E+1	SP05
	Ø 150	8E+1+6	SP06
	Ø 150	8E+1+8I	SP07
	Ø 150	9	SP08
	Ø 200	8	SP09

➤ Pre-perforated discs

shape	diameter	code
	Ø 115/75	S131
	Ø 125/75	S133



PRE-PERFORATED DISCS

Discs without perforations/centre holes

DISCS WITHOUT PERFORATIONS/
CENTRE HOLES

shape	diameter	code
	Ø 19	S001
	Ø 22	S002
	Ø 25	S003
	Ø 45	S004
	Ø 50	S005
	Ø 60	S006
	Ø 75	S007
	Ø 100	S100
	Ø 115	S104
	Ø 125	S105
	Ø 150	S106
	Ø 175	S114
	Ø 178	S118
	Ø 200	S200
	Ø 215	S209
	Ø 225	S204
	Ø 230	S205
	Ø 250	S206
	Ø 300	S300
	Ø 330	S330
Ø 350	S306	
Ø 381	S311	
Ø 400	S400	
Ø 430	S415	
Ø 500	S500	
Ø 600	S600	
Ø 770	S770	
Ø 810	S810	





Discs with centre holes

shape	diameter	centre hole	code
	Ø 95	10	S008
	Ø 100	10	S128
	Ø 100	15	S101
	Ø 100	30	S102
	Ø 105	6	S103
	Ø 115	10	S107
	Ø 115	50	S129
	Ø 125	10	S109
	Ø 140	35	S122
	Ø 150	22	S108
	Ø 150	22,2	S127
	Ø 150	50	S126
	Ø 160	40	S110
	Ø 180	10	S130
	Ø 200	25	S203
	Ø 250	25	S207
	Ø 300	25	S302
Ø 350	8	S303	
Ø 350	40	S304	
	Ø 200	10	S201
	Ø 200	25+2	S202
	Ø 300	25+2	S307
	Ø 381	127	S305

DISCS WITH CENTRE HOLES

> Discs with centre holes and central slots

DISCS WITH CENTRE HOLES AND
CENTRAL SLOTS

shape	diameter	centre hole	code
	Ø 150	10	S111
	Ø 178	8	S115
	Ø 178	14	S116
	Ø 115	22	S120
	Ø 125	22	S121
	Ø 150	25	S112
	Ø 175	25	S113
	Ø 178	22	S117
	Ø 175	22	S119
	Ø 115	22	S123

>>

shape	diameter	centre hole	code
	Ø 150	30	S124
	Ø 178	22	S125
	Ø 406	101	S401



At Cibo made to order is our standard. Contact us for more information.

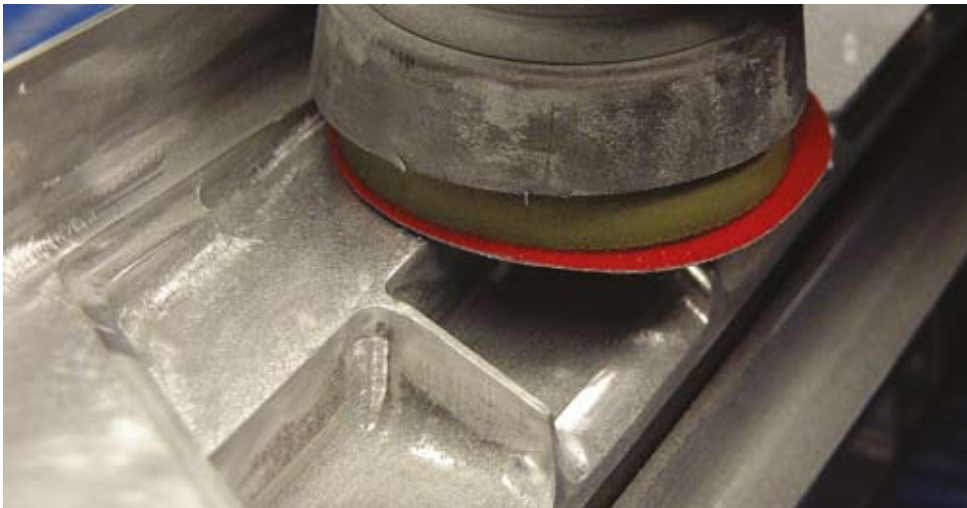

> Film grip discs

A/O

FILM

SA331

application	backing	weight	grit type	coating	waterproof
	Film	-	A/O	●	💧

Grit range: 40-60-80-100-120-150-180-220-320-400-600-800-1200

Description: Open coated aluminium oxide grit with an active abrasive ingredient on a film backing. Extremely tear-resistant. Does not clog up, long life span, extremely large grit size range. Can be used for many purposes, especially with more intensive grinding operations. Ideal for finishing of soft wood types and car repair, paints, lacquers and varnishes. Used both wet and dry.



diameter	holes	shape	grit	code	stock	
Ø 150	0	S106	40	331GR/40/S106	●	50
			60	331GR/60/S106	●	50
			80	331GR/80/S106	●	100
			100	331GR/100/S106	●	100
			120	331GR/120/S106	●	100
			150	331GR/150/S106	●	100
			180	331GR/180/S106	●	100
			220	331GR/220/S106	●	100
			320	331GR/320/S106	●	100
			400	331GR/400/S106	●	100
			600	331GR/600/S106	●	100
			800	331GR/800/S106	●	100
Ø 150	6	SP03	40	331GR/40/SP03	●	50
			60	331GR/60/SP03	●	50
			80	331GR/80/SP03	●	100
			100	331GR/100/SP03	●	100
			120	331GR/120/SP03	●	100
			150	331GR/150/SP03	●	100
			180	331GR/180/SP03	●	100
			220	331GR/220/SP03	●	100
			320	331GR/320/SP03	●	100
			400	331GR/400/SP03	●	100
			600	331GR/600/SP03	●	100
			800	331GR/800/SP03	●	100
1200	331GR/1200/SP03	●	100			

>>

SA331

diameter	holes	shape	grit	code	stock	
Ø 150	8 I	SP04	40	331GR/40/SP04	●	50
			60	331GR/60/SP04	●	50
			80	331GR/80/SP04	●	100
			100	331GR/100/SP04	●	100
			120	331GR/120/SP04	●	100
			150	331GR/150/SP04	●	100
			180	331GR/180/SP04	●	100
			220	331GR/220/SP04	●	100
			320	331GR/320/SP04	●	100
			400	331GR/400/SP04	●	100
			600	331GR/600/SP04	●	100
			800	331GR/800/SP04	●	100
			1200	331GR/1200/SP04	●	100
			Ø 150	8E + 1	SP05	40
60	331GR/60/SP05	●				50
80	331GR/80/SP05	●				100
100	331GR/100/SP05	●				100
120	331GR/120/SP05	●				100
150	331GR/150/SP05	●				100
180	331GR/180/SP05	●				100
220	331GR/220/SP05	●				100
320	331GR/320/SP05	●				100
400	331GR/400/SP05	●				100
600	331GR/600/SP05	●				100
800	331GR/800/SP05	●				100
1200	331GR/1200/SP05	●				100

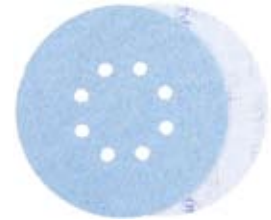

● = available from stock

● = available in 5 working days

● = on request

> Paper grip discs

A/O

PAPER

CA330

application	backing	weight	grit type	coating	waterproof
	Paper	C	A/O	●	-

Grit range: 60-80-100-120-150-180-220-240-320-400-500-600

Description: Open coated aluminium oxide with grinding aid on flexible "C" paper. Very pliable and flexible, cannot saturate, adapts easily to the workpiece and guarantees a beautiful, even finish. Ideal for grinding primary coats, primers, sealers, lacquers, paint, varnish, filler and wood.

diameter	holes	shape	grit	code	stock	
Ø 115	0	S104	60	330GR/60/S104	●	50
			80	330GR/80/S104	●	100
			100	330GR/100/S104	●	100
			120	330GR/120/S104	●	100
			150	330GR/150/S104	●	100
			180	330GR/180/S104	●	100
			220	330GR/220/S104	●	100
			240	330GR/240/S104	●	100
			320	330GR/320/S104	●	100
			400	330GR/400/S104	●	100
			500	330GR/500/S104	●	100
Ø 125	0	S105	60	330GR/60/S105	●	50
			80	330GR/80/S105	●	100
			100	330GR/100/S105	●	100
			120	330GR/120/S105	●	100
			150	330GR/150/S105	●	100
			180	330GR/180/S105	●	100
			220	330GR/220/S105	●	100
			240	330GR/240/S105	●	100
			320	330GR/320/S105	●	100
			400	330GR/400/S105	●	100
			500	330GR/500/S105	●	100
600	330GR/600/S105	●	100			



>>

CA330

diameter	holes	shape	grit	code	stock	
Ø 150	0	S106	60	330GR/60/S106	●	50
			80	330GR/80/S106	●	100
			100	330GR/100/S106	●	100
			120	330GR/120/S106	●	100
			150	330GR/150/S106	●	100
			180	330GR/180/S106	●	100
			220	330GR/220/S106	●	100
			240	330GR/240/S106	●	100
			320	330GR/320/S106	●	100
			400	330GR/400/S106	●	100
			500	330GR/500/S106	●	100
			600	330GR/600/S106	●	100
			Ø 150	6	SP03	60
80	330GR/80/SP03	●				100
100	330GR/100/SP03	●				100
120	330GR/120/SP03	●				100
150	330GR/150/SP03	●				100
180	330GR/180/SP03	●				100
220	330GR/220/SP03	●				100
240	330GR/240/SP03	●				100
320	330GR/320/SP03	●				100
400	330GR/400/SP03	●				100
500	330GR/500/SP03	●				100
600	330GR/600/SP03	●				100
Ø 150	8 l	SP04				60
			80	330GR/80/SP04	●	100
			100	330GR/100/SP04	●	100
			120	330GR/120/SP04	●	100
			150	330GR/150/SP04	●	100
			180	330GR/180/SP04	●	100
			240	330GR/240/SP04	●	100



>>

● = available from stock

● = available in 5 working days

● = on request



CA330

diameter	holes	shape	grit	code	stock	
Ø 150	8 l	SP04	320	330GR/320/SP04	●	100
			400	330GR/400/SP04	●	100
			500	330GR/500/SP04	●	100
			600	330GR/600/SP04	●	100
Ø 150	8E + 1	SP05	60	330GR/60/SP05	●	50
			80	330GR/80/SP05	●	100
			100	330GR/100/SP05	●	100
			120	330GR/120/SP05	●	100
			150	330GR/150/SP05	●	100
			180	330GR/180/SP05	●	100
			220	330GR/220/SP05	●	100
			240	330GR/240/SP05	●	100
			320	330GR/320/SP05	●	100
			400	330GR/400/SP05	●	100
			500	330GR/500/SP05	●	100
			600	330GR/600/SP05	●	100

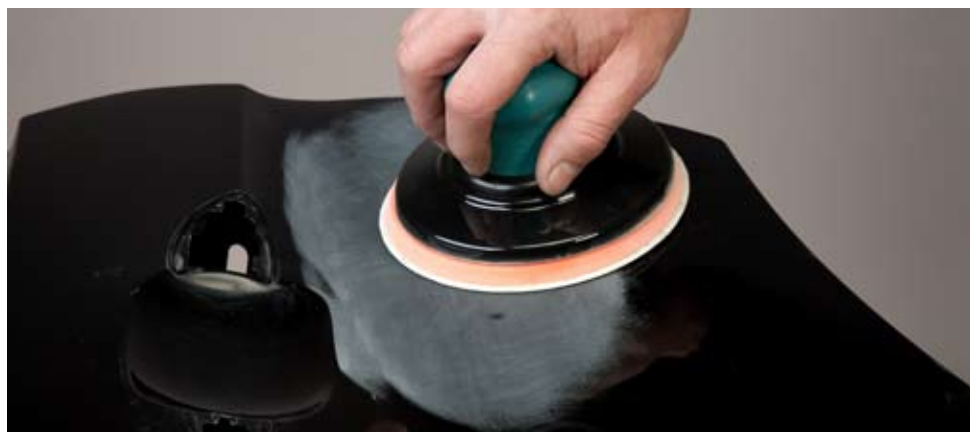

➤ Paper grip discs

KP947F

application	backing	weight	grit type	coating	waterproof
	Paper	F	A/O	-	-

Grit range: 240-280-320-400

Description: Antistatic, closed coated aluminium oxide on a very strong "F" paper base. The antistatic property ensures the easy removal of dust. The KP947F is a product that can be used for various purposes. Perfect grade for both dry and hard woods as well as for those of a softer quality with a higher level of resin.

Please consult Cibo on sizes, qualities and grit.

PAPER

A/O



● = available from stock

● = available in 5 working days

● = on request



KP949FO

diameter	holes	shape	grit	code	stock	
Ø 150	6	SP03	40	949GR/40/SP03	●	50
			60	949GR/60/SP03	●	100
			80	949GR/80/SP03	●	100
			100	949GR/100/SP03	●	100
			120	949GR/120/SP03	●	100
			150	949GR/150/SP03	●	100
			180	949GR/180/SP03	●	100
			220	949GR/220/SP03	●	100

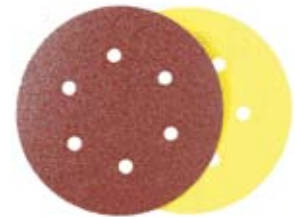

Please consult Cibo for additional sizes, quality or grit.



● = available from stock

● = available in 5 working days

● = on request

> Paper grip discs

ZIRC.

PAPER

KP950F



application	backing	weight	grit type	coating	waterproof
	Paper	F	ZIRC.	-	-

Grit range: 40-60-80-100-120-150-180-220

Description: Zirconium oxide grain on an "F" paper base. This product is ideally suited for grinding very hard and dry woods because of the extremely abrasive-resistant zirconium oxide grit. The KP950F is also highly efficient when using stainless steel.

diameter	holes	shape	grit	code	stock	
Ø 115	0	S104	40	950GR/40/S104	●	100
			60	950GR/60/S104	●	100
			80	950GR/80/S104	●	100
			120	950GR/120/S104	●	100
Ø 125	0	S105	40	950GR/40/S105	●	100
			60	950GR/60/S105	●	100
			80	950GR/80/S105	●	100
			120	950GR/120/S105	●	100
Ø 150	0	S106	40	950GR/40/S106	●	100
			60	950GR/60/S106	●	100
			80	950GR/80/S106	●	100
			120	950GR/120/S106	●	100





● = available from stock

● = available in 5 working days

● = on request

> Paper grip discs

S/C

PAPER

SP706F



application	backing	weight	grit type	coating	waterproof
	Paper	F	S/C	-	-

Grit range: 24-36-40-60-80-100-120-220-320-400-500-600-800-1000-1200

Description: Antistatic silicon carbide grit on a very strong "F" base. Ideally suited for use in sanding wooden floors and parquet.

diameter	holes	shape	grit	code	stock	
Ø 115	0	S104	24	706GR/24/S104	●	50
			36	706GR/36/S104	●	50
			40	706GR/40/S104	●	50
			60	706GR/60/S104	●	100
			80	706GR/80/S104	●	100
			120	706GR/120/S104	●	100
			220	706GR/220/S104	●	100
			320	706GR/320/S104	●	100
			400	706GR/400/S104	●	100
			500	706GR/500/S104	●	100
			600	706GR/600/S104	●	100
			800	706GR/800/S104	●	100
			1000	706GR/1000/S104	●	100
1200	706GR/1200/S104	●	100			
Ø 125	0	S105	24	706GR/24/S105	●	50
			36	706GR/36/S105	●	50
			40	706GR/40/S105	●	50
			60	706GR/60/S105	●	100
			80	706GR/80/S105	●	100
			120	706GR/120/S105	●	100
			220	706GR/220/S105	●	100
			320	706GR/320/S105	●	100
400	706GR/400/S105	●	100			
500	706GR/500/S105	●	100			



SP706F

diameter	holes	shape	grit	code	stock	
Ø 125	0	S105	600	706GR/600/S105	●	100
			800	706GR/800/S105	●	100
			1000	706GR/1000/S105	●	100
			1200	706GR/1200/S105	●	100
Ø 150	0	S106	24	706GR/24/S106	●	50
			36	706GR/36/S106	●	50
			40	706GR/40/S106	●	50
			60	706GR/60/S106	●	100
			80	706GR/80/S106	●	100
			120	706GR/120/S106	●	100
			220	706GR/220/S106	●	100
			320	706GR/320/S106	●	100
			400	706GR/400/S106	●	100
			500	706GR/500/S106	●	100
			600	706GR/600/S106	●	100
			800	706GR/800/S106	●	100
1000	706GR/1000/S106	●	100			
1200	706GR/1200/S106	●	100			



Please consult Cibo for additional sizes, quality or grit.

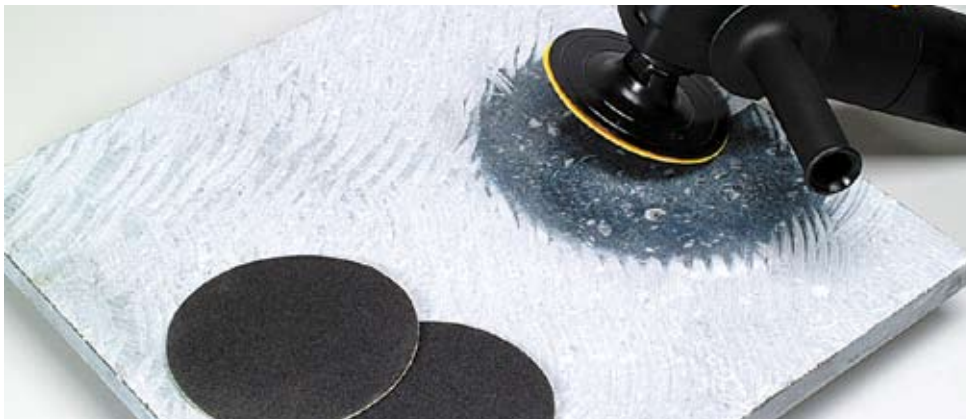

● = available from stock

● = available in 5 working days

● = on request







>>

SP706F

diameter	holes	shape	grit	code	stock	
Ø 381	0	S311	24	706GR/24/S311	●	20
			36	706GR/36/S311	●	20
			40	706GR/40/S311	●	20
			60	706GR/60/S311	●	20
			80	706GR/80/S311	●	20
			120	706GR/120/S311	●	20
			220	706GR/220/S311	●	20
Ø 400	0	S400	24	706GR/24/S400	●	20
			36	706GR/36/S400	●	20
			40	706GR/40/S400	●	20
			60	706GR/60/S400	●	20
			80	706GR/80/S400	●	20
Ø 430	0	S415	24	706GR/24/S415	●	20
			36	706GR/36/S415	●	20
			40	706GR/40/S415	●	20
			60	706GR/60/S415	●	20
			80	706GR/80/S415	●	20

➤ Paper grip discs

LKE22

application	backing	weight	grit type	coating	waterproof
   	Combina- tion	–	S/C	–	–

Grit range: 16-20

Description: Combination abrasive material. A heavy F paper reinforced with a light fabric and provided with a very open silicon carbide grit structure. Primarily for use in sanding old and dirty wooden floors and parquet. Also suitable for removing old paint, glue and varnish layers or carpet remains.

Please consult Cibo on sizes, qualities and grit.

PAPER

S/C



● = available from stock

● = available in 5 working days

● = on request



> Paper double-sided discs

S/C





















PAPER

SP706F



application	backing	weight	grit type	coating	waterproof
 	Paper	F	S/C	-	-
Grit range: 16-24-36-40-50-60-80-100-120-150-180-220-240-280-320-400-500-600-800-1000-1200					
Description: Antistatic silicon carbide grit on a very strong "F" base. Ideally suited for use in sanding wooden floors and parquet.					
diameter	holes	grit	code	stock 	
Ø 381	0	16	SD381-16	●	10
		24	SD381-24	●	10
		36	SD381-36	●	10
		40	SD381-40	●	10
		60	SD381-60	●	10
		80	SD381-80	●	10
		100	SD381-100	●	10
		120	SD381-120	●	10
		150	SD381-150	●	10
Ø 400	0	16	SD400-16	●	10
		24	SD400-24	●	10
		36	SD400-36	●	10
		40	SD400-40	●	10
		60	SD400-60	●	10
		80	SD400-80	●	10
		100	SD400-100	●	10
		120	SD400-120	●	10
		150	SD400-150	●	10
Ø 430	0	16	SD430-16	●	10
		24	SD430-24	●	10
		36	SD430-36	●	10
		40	SD430-40	●	10
		60	SD430-60	●	10
		80	SD430-80	●	10
		100	SD430-100	●	10
		120	SD430-120	●	10
		150	SD430-150	●	10

Mesh discs

QNSH						
application	backing	weight	grit type	coating	waterproof	
	Sanding mesh	-	S/C	-		
Grit range: 40-60-80-100-120-150-180-220-320-400-600						
Description: Open polyester web structure to which grits are anchored on both sides.						
diameter	holes	shape	grit	code	stock	
Ø 381	0	S311	40	QNSH/40/S311		10
			60	QNSH/60/S311		10
			80	QNSH/80/S311		10
			100	QNSH/100/S311		10
			120	QNSH/120/S311		10
			150	QNSH/150/S311		10
Ø 400	0	S400	40	QNSH/40/S400		10
			60	QNSH/60/S400		10
			80	QNSH/80/S400		10
			100	QNSH/100/S400		10
			120	QNSH/120/S400		10
			150	QNSH/150/S400		10
Ø 430	0	S415	40	QNSH/40/S415		10
			60	QNSH/60/S415		10
			80	QNSH/80/S415		10
			100	QNSH/100/S415		10
			120	QNSH/120/S415		10
			150	QNSH/150/S415		10

MESH

S/C

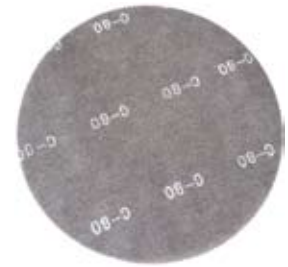

● = available from stock

● = available in 5 working days

● = on request

> Cloth grip discs

ZIRC.

CLOTH ABRASIVES

TZ59



application	backing	weight	grit type	coating	waterproof
	Cotton	X	ZIRC.	-	-
Grit range: 36-40-50-60-80-100-120					
Description: High-quality aluminium/zirconium oxide on a highly resistant "X" backing. Ideal for professional applications on stainless steel, aluminium, metal, non-ferrous metals and hard wood.					
<i>Please consult Cibo on sizes, qualities and grit.</i>					

CER.

CLOTH ABRASIVES

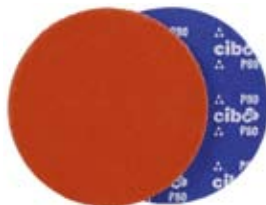

777F



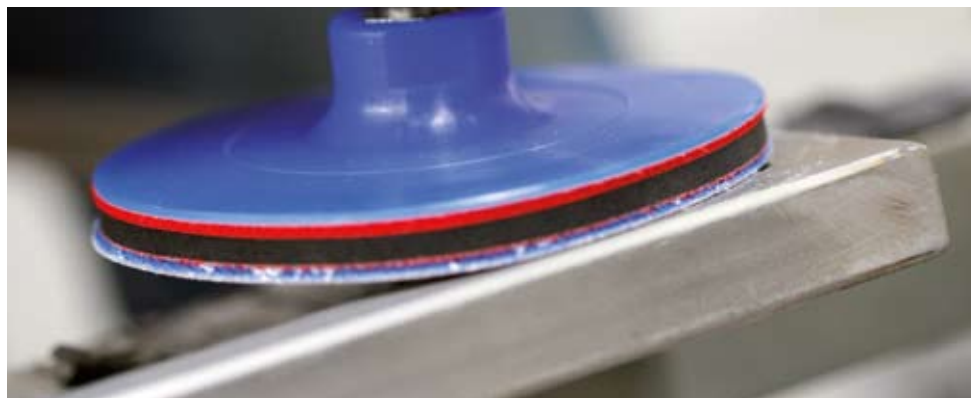

application	backing	weight	grit type	coating	waterproof	
	Cloth	H	CER.	●	💧	
Grit range: 40-60-80-100-120						
Description: Ceramic grit with added grinding aids on a stable polyester backing. Can be used both wet and dry. Ideal product for medium-heavy applications.						
diameter	holes	shape	grit	code	stock	
Ø 115	0	S104	80	777GR/80/S104	●	50
			100	777GR/100/S104	●	50
			120	777GR/120/S104	●	50
Ø 125	0	S105	80	777GR/80/S105	●	50
			100	777GR/100/S105	●	50
			120	777GR/120/S105	●	50



Finishing Kit

FIGKT				
code		stock		
FIGKT		●		1
content	code	diameter	grit	
	777GR/100/S104 (kit)	Ø 115	P100	2
	237GR/160/S104 (kit)	Ø 115	A160 (P120)	5
	237GR/65/S104 (kit)	Ø 115	A65 (P280)	5
	237GR/45/S104 (kit)	Ø 115	A45 (P400)	5
	115VELVZ (kit)	Ø 115	–	1
	115IT (kit)	Ø 115	–	1

code		stock		
FIGKT125		●		1
content	code	diameter	grit	
	777GR/100/S133 (kit)	Ø 125/75	P100	2
	237GR/160/S133 (kit)	Ø 125/75	A160 (P120)	5
	237GR/65/S133 (kit)	Ø 125/75	A65 (P280)	5
	237GR/45/S133 (kit)	Ø 125/75	A45 (P400)	5
	125VELVZ (kit)	Ø 125	–	1
	125IT (kit)	Ø 125	–	1
	75VELVZ (kit)	Ø 75	–	1
	75IT (kit)	Ø 75	–	1

FINISHING KIT

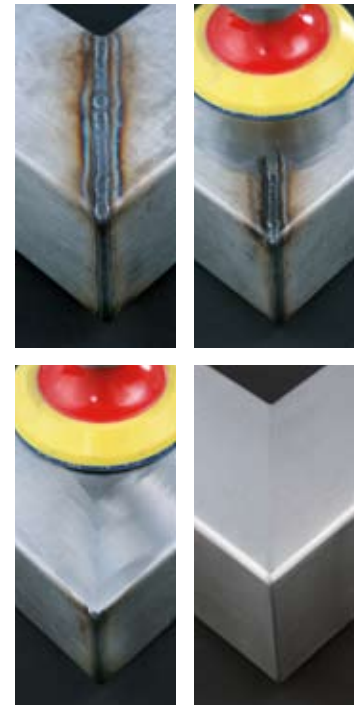

Sanding mitres - a piece of cake!

The Cibo Finishing Kit allows you to grind down a weld seam on a surface in just a few steps, without risking any damage to the workpiece. Once the weld seam has been completely removed using the Finishing Kit, you can use the new Cibo tex-brushes with M14 connection, which can be easily mounted on a angle-grinder with adjustable speed, to imitate very quickly the existing brush structure of the work piece. In combination with the Cibo Inoxitape, you can create a perfect angle in mitre in no time at all, as if there had never been any welding seam on the workpiece.

Tex wheels with M14 connection: see p. 327

Inoxitape: see p. 490

● = available from stock

● = available in 5 working days

● = on request

> Cloth grip discs

A/O TRIZACT™ CLOTH ABRASIVES

237AA

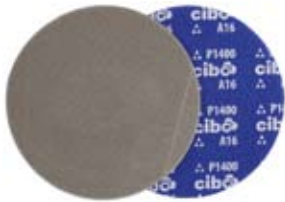

Back-up pad



Interface foam

application	backing	weight	grit type	coating	waterproof
	Cotton	X	A/O Trizact™	-	-

Grit range: A160 (P120)-A100 (P220)-A80 (P240)-A65 (P280)-A45 (P400)-A30 (P600)-A16 (P1400)-A6 (P2000)

Description: This is a product of the Trizact™ family (3M). Trizact™ is an innovative grinding material produced with perfectly calibrated aluminium oxide grit in a pyramid shape. This three-dimensional grit of identical height ensure quick stock removal and an even and replicable finish without deep scratching or risk of burrs. This product has been especially developed for material that is difficult to work, such as stainless steel and exotic alloys, as used in aviation and space travel and in the medical sector. In addition, it has been used successfully in the finishing of copper, bronze, aluminium, composite materials and synthetic materials. The 237AA is not suited for use on titanium.

dia-meter	holes	shape	grit	code	back-up pad	interface foam	stock	
Ø 115	0	S104	A160 (P120)	237GR/160/S104	115VELVZ	115IT		50
			A80 (P240)	237GR/80/S104				50
			A65 (P280)	237GR/65/S104				50
			A45 (P400)	237GR/45/S104				50
			A30 (P600)	237GR/30/S104				50
			A16 (P1400)	237GR/16/S104				50
			A6 (P2000)	237GR/6/S104				50
Ø 125	0	S105	A160 (P120)	237GR/160/S105	125VELVZ	125IT		50
			A80 (P240)	237GR/80/S105				50
			A65 (P280)	237GR/65/S105				50
			A45 (P400)	237GR/45/S105				50
			A30 (P600)	237GR/30/S105				50
			A16 (P1400)	237GR/16/S105				50
			A6 (P2000)	237GR/6/S105				50
Ø 115/75	0	S131	A160 (P120)	237GR/160/S131	115VELVZ / 75VELVZ	115IT / 75IT		50
			A80 (P240)	237GR/80/S131				50
			A65 (P280)	237GR/65/S131				50
			A45 (P400)	237GR/45/S131				50
			A30 (P600)	237GR/30/S131				50
			A16 (P1400)	237GR/16/S131				50
			A6 (P2000)	237GR/6/S131				50





237AA

dia- meter	holes	shape	grit	code	back-up pad	interface foam	stock	
∅ 125/75	0	S133	A160 (P120)	237GR/160/S133	125VELVZ / 75VELVZ	125IT / 75IT	●	50
			A80 (P240)	237GR/80/S133			●	50
			A65 (P280)	237GR/65/S133			●	50
			A45 (P400)	237GR/45/S133			●	50
			A30 (P600)	237GR/30/S133			●	50
			A16 (P1400)	237GR/16/S133			●	50
			A6 (P2000)	237GR/6/S133			●	50

Trizact™ is a registered trademark of the 3M Company.



Always use in combination with a heat-resistant back-up pad and foam interface (see p. 473).

S104 = ∅115 mm: back-up pad **115VELVZ** + foam interface **115IT**

S105 = ∅125 mm: back-up pad **125VELVZ** + foam interface **125IT**

S131 = ∅115/75 mm: back-up pad **115VELVZ/75VELVZ** + foam interface **115IT/75IT**

S133 = ∅125/75 mm: back-up pad **125VELVZ/75VELVZ** + foam interface **125IT/75IT**



● = available from stock

● = available in 5 working days

● = on request

> Cloth grip discs

A/O TRIZACT™ CLOTH ABRASIVES



337DC

application	backing	weight	grit type	coating	waterproof
	Cotton	X	A/O Trizact™	-	-

Grit range: A300 (P80)-A160(P120)-A100 (P220)-A65 (P280)-A45 (P400)

Description: The properties of the 337DC Trizact™ grade are similar to those of the 237AA, but the 337DC has a higher stock removal capacity.

Please consult Cibo on sizes, qualities and grit.

Trizact™ is a registered trademark of the 3M Company.

CALIBRATED A/O CLOTH ABRASIVES



MFR

application	backing	weight	grit type	coating	waterproof
	Cotton	F	Calibrated A/O	-	

Grit range: MFR1500 (P600)-MFR1800 (P1200)-MFR2400 (P1500)-MFR3200 (P2500)-MFR3600 (P3000)-MFR4000 (P4000)-MFR6000 (P5000)-MFR8000 (P6000)-MFR12000 (P8000)

Description: Micro-Mesh is a concept whereby extremely precisely calibrated grit crystals are bonded with a flexible glue on a supple cotton base. Due to the elastic positioning, this grit always comes in contact with the workpiece at a positive angle. This ensures a constant and even scratch depth. This ingeniously thought out design guarantees an extremely even, constant and precise finishing pattern.

Please consult Cibo on sizes, qualities and grit.

CALIBRATED A/O CLOTH ABRASIVES



MFX

application	backing	weight	grit type	coating	waterproof
	Cotton	J	Calibrated A/O	-	

Grit range: MFX180 (P600)-MFX240 (P1200)-MFX320 (P1500)-MFX400 (P3000)-MFX600 (P3500)-MFX800 (P4000)-MFX1200 (P6000)



















Description: Micro-Mesh is a concept whereby extremely precisely calibrated grit crystals are bonded with a flexible glue on a supple cotton base. Due to the elastic positioning, this grit always comes in contact with the workpiece at a positive angle. This ensures a constant and even scratch depth. This ingeniously thought out design guarantees an extremely even, constant and precise finishing pattern.

Please consult Cibo on sizes, qualities and grit.



(*) Micro-mesh achieves the best results provided a light mist is used. The use of an excessive amount of water is not recommended with Micro-mesh.

Tex grip discs

A/O						
application	backing	weight	grit type	coating	waterproof	
	Nylon web	-	A/O	-		
Grit range: A-Coarse - A-Medium - A-Fine - A-Very Fine STRONG - A-Very Fine SOFT - A-Very Fine SUPERSOFT						
Description: The nylon fibres are combined into a three- dimensional web structure using thermo-setting synthetic resin, and are available in various grit types with an aluminium oxide grit. The result is an elastic abrasive material with an open structure that is easy to use and provides an even and constant finish. The tex material does not affect the geometrical shape of the work pieces. A/O creates a good long-lasting finish at high speeds.						
diameter	holes	shape	grit	code	stock	
Ø 115	0	S104	AC	TGR/AC/S104		10
			AM	TGR/AM/S104		10
			AF	TGR/AF/S104		10
			AVFStrong	TGR/AVFStrong/S104		10
			AVFSoft	TGR/AVFSoft/S104		10
Ø 125	0	S105	AC	TGR/AC/S105		10
			AM	TGR/AM/S105		10
			AF	TGR/AF/S105		10
			AVFStrong	TGR/AVFStrong/S105		10
			AVFSoft	TGR/AVFSoft/S105		10
Ø 150	0	S106	AC	TGR/AC/S106		10
			AM	TGR/AM/S106		10
			AF	TGR/AF/S106		10
			AVFStrong	TGR/AVFStrong/S106		10
			AVFSoft	TGR/AVFSoft/S106		10



There are **four main groups** in tex materials.

A = Tex with aluminium oxide grit type

S = Tex with silicon carbide grit type

CP = Tex with high grade aluminium oxide and an improved resin formula

00 = Tex without grit type

The Tex **grit size** is shown with letter combinations, in contrast to the classic abrasive materials.

AC = Aluminium oxide **Coarse**

AM = Aluminium oxide **Medium**

AF = Aluminium oxide **Fine**

AVF = Aluminium oxide **Very Fine**

 = available from stock

 = available in 5 working days

 = on request

Tex grip discs

S/C

TEX

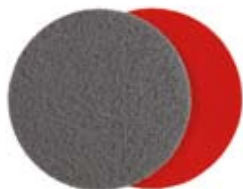

S/C

application	backing	weight	grit type	coating	waterproof
	Nylon web	-	S/C	-	

Grit range: S-Medium - S-Fine - S-Very Fine - S-Ultra Fine 600 - S-Ultra Fine 1000 - S-Ultra Fine 1200

Description: The nylon fibres are combined into a three-dimensional web structure using thermo-setting synthetic resin, and are available in various grit sizes with silicon carbide grit. The result is an elastic abrasive material with an open structure that is easy to use and provides an even and constant finish. The tex material does not affect the geometrical shape of the work pieces. In comparison with the A/O, S/C provides a finer, more even and matt texture. Primarily used to create a decorative finish.

diameter	holes	shape	grit	code	stock	
Ø 115	0	S104	SM	TGR/SM/S104		10
			SF	TGR/SF/S104		10
			SVF	TGR/SVF/S104		10
			SUF600	TGR/SUF600/S104		10
			SUF1000	TGR/SUF1000/S104		10
			SUF1200	TGR/SUF1200/S104		10
Ø 125	0	S105	SM	TGR/SM/S105		10
			SF	TGR/SF/S105		10
			SVF	TGR/SVF/S105		10
			SUF600	TGR/SUF600/S105		10
			SUF1000	TGR/SUF1000/S105		10
			SUF1200	TGR/SUF1200/S105		10
Ø 150	0	S106	SM	TGR/SM/S106		10
			SF	TGR/SF/S106		10
			SVF	TGR/SVF/S106		10
			SUF600	TGR/SUF600/S106		10
			SUF1000	TGR/SUF1000/S106		10
			SUF1200	TGR/SUF1200/S106		10



The **Tex grit** size is shown with letter combinations, in contrast to the classic abrasive materials.

SM = silicon carbide **Medium**

SF = silicon carbide **Fine**

SVF = silicon carbide **Very Fine**

SUF = silicon carbide **Ultra Fine**

Tex grip discs

CP						
application		backing	weight	grit type	coating	waterproof
		Nylon web	-	A/O CP	-	-
Grit range: CP						
<p>Description: The nylon fibres are combined into a three-dimensional web structure using thermo-setting synthetic resin with an aluminium oxide grit type. The result is an elastic abrasive material with an open structure that is easy to use and provides an even and constant finish. The tex material does not affect the geometrical shape of the work pieces. CP has an increased grinding capacity at higher speeds. This material provides the brush structure with a slightly glossy effect.</p>						
diameter	holes	shape	grit	code	stock	
Ø 115	0	S104	CP	TGR/CP/S104	●	10
Ø 125	0	S105	CP	TGR/CP/S105	●	10
Ø 150	0	S106	CP	TGR/CP/S106	●	10

TEX

A/O CP



● = available from stock

● = available in 5 working days

● = on request

> Tex grip discs

- TEX



00						
application	backing	weight	grit type	coating	waterproof	
	Nylon web	-	-	-		
Grit range: no grit						
Description: With the TEX 00, the nylon fibres are combined into a three-dimensional web structure using thermo-setting synthetic resin without abrasive grit. This material does not scratch and is ideally suited for cleaning.						
diameter	holes	shape	grit	code	stock	
Ø 115	0	S104	00	TGR/00/S104	●	10
Ø 125	0	S105	00	TGR/00/S105	●	10
Ø 150	0	S106	00	TGR/00/S106	●	10

> Tex discs without centre holes

A/O TEX



A/O						
application	backing	weight	grit type	coating	waterproof	
	Nylon web	-	A/O	-		
Grit range: A-Coarse - A-Medium - A-Fine - A-Very Fine STRONG - A-Very Fine SOFT - A-Very Fine SUPERSOFT						
Description: The nylon fibres are combined into a three-dimensional web structure using thermo-setting synthetic resin, and are available in various grit types with an aluminium oxide grit. The result is an elastic abrasive material with an open structure that is easy to use and provides an even and constant finish. The tex material does not affect the geometrical shape of the work pieces. A/O creates a good long-lasting finish at high speeds.						
diameter	holes	shape	grit	code	stock	
Ø 381	0	S311	AF	TZA/AF/S311	●	10
			AVFStrong	TZA/AVFStrong/S311	●	10
Ø 400	0	S400	AF	TZA/AF/S400	●	10
			AVFStrong	TZA/AVFStrong/S400	●	10
Ø 430	0	S415	AF	TZA/AF/S415	●	10
			AVFStrong	TZA/AVFStrong/S415	●	10

Tex discs without centre holes

S/C					
application	backing	weight	grit type	coating	waterproof
	Nylon web	-	S/C	-	

Grit range: S-Medium - S-Fine - S-Very Fine - S-Ultra Fine 600 - S-Ultra Fine 1000 - S-Ultra Fine 1200

Description: The nylon fibres are combined into a three-dimensional web structure using thermo-setting synthetic resin, and are available in various grit sizes with silicon carbide grit. The result is an elastic abrasive material with an open structure that is easy to use and provides an even and constant finish. The tex material does not affect the geometrical shape of the work pieces. In comparison with the A/O, S/C provides a finer, more even and matt texture. Primarily used to create a decorative finish.

diameter	holes	shape	grit	code	stock	
Ø 381	0	S311	SM	TZA/SM/S311		10
			SF	TZA/SF/S311		10
			SVF	TZA/SVF/S311		10
			SUF600	TZA/SUF600/S311		10
Ø 400	0	S400	SM	TZA/SM/S400		10
			SF	TZA/SF/S400		10
			SVF	TZA/SVF/S400		10
			SUF600	TZA/SUF600/S400		10
Ø 430	0	S415	SM	TZA/SM/S415		10
			SF	TZA/SF/S415		10
			SVF	TZA/SVF/S415		10
			SUF600	TZA/SUF600/S415		10

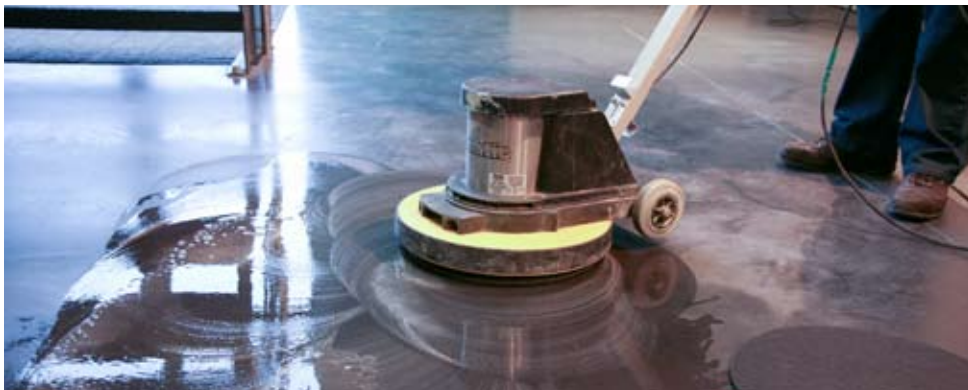

= available from stock

= available in 5 working days

= on request

> Tex discs with centre holes

A/O

TEX



A/O

application	backing	weight	grit type	coating	waterproof
	Nylon web	-	A/O	-	

Grit range: A-Coarse - A-Medium - A-Fine - A-Very Fine STRONG - A-Very Fine SOFT - A-Very Fine SUPERSOFT

Description: The nylon fibres are combined into a three- dimensional web structure using thermo-setting synthetic resin, and are available in various grit types with an aluminium oxide grit. The result is an elastic abrasive material with an open structure that is easy to use and provides an even and constant finish. The tex material does not affect the geometrical shape of the work pieces. A/O creates a good long-lasting finish at high speeds.

diameter	centre hole	shape	grit	code	stock	
Ø 200	Ø 25	S203	AC	TMA/AC/S203	●	10
			AM	TMA/AM/S203	●	10
			AF	TMA/AF/S203	●	10
			AVFStrong	TMA/AVFStrong/S203	●	10
			AVFSoft	TMA/AVFSoft/S203	●	10
Ø 250	Ø 25	S207	AC	TMA/AC/S207	●	10
			AM	TMA/AM/S207	●	10
			AF	TMA/AF/S207	●	10
			AVFStrong	TMA/AVFStrong/S207	●	10
			AVFSoft	TMA/AVFSoft/S207	●	10
Ø 300	Ø 25	S302	AC	TMA/AC/S302	●	10
			AM	TMA/AM/S302	●	10
			AF	TMA/AF/S302	●	10
			AVFStrong	TMA/AVFStrong/S302	●	10
			AVFSoft	TMA/AVFSoft/S302	●	10

> Tex discs with centre holes

S/C						
application	backing	weight	grit type	coating	waterproof	
	Nylon web	-	S/C	-		
Grit range: S-Medium - S-Fine - S-Very Fine - S-Ultra Fine 600 - S-Ultra Fine 1000 - S-Ultra Fine 1200						
Description: The nylon fibres are combined into a three-dimensional web structure using thermo-setting synthetic resin, and are available in various grit sizes with silicon carbide grit. The result is an elastic abrasive material with an open structure that is easy to use and provides an even and constant finish. The tex material does not affect the geometrical shape of the work pieces. In comparison with the A/O, S/C provides a finer, more even and matt texture. Primarily used to create a decorative finish.						
diameter	centre hole	shape	grit	code	stock	
Ø 200	Ø 25	S203	SM	TMA/SM/S203		10
			SF	TMA/SF/S203		10
			SVF	TMA/SVF/S203		10
			SUF600	TMA/SUF600/S203		10
			SUF1000	TMA/SUF1000/S203		10
			SUF1200	TMA/SUF1200/S203		10
Ø 250	Ø 25	S207	SM	TMA/SM/S207		10
			SF	TMA/SF/S207		10
			SVF	TMA/SVF/S207		10
			SUF600	TMA/SUF600/S207		10
			SUF1000	TMA/SUF1000/S207		10
			SUF1200	TMA/SUF1200/S207		10
Ø 300	Ø 25	S302	SM	TMA/SM/S302		10
			SF	TMA/SF/S302		10
			SVF	TMA/SVF/S302		10
			SUF600	TMA/SUF600/S302		10
			SUF1000	TMA/SUF1000/S302		10
			SUF1200	TMA/SUF1200/S302		10

TEX S/C



= available from stock

= available in 5 working days

= on request

Tex discs with centre holes

A/O CP TEX



CP

application	backing	weight	grit type	coating	waterproof
	Nylon web	-	A/O CP	-	

Grit range: CP



Description: The nylon fibres are combined into a three-dimensional web structure using thermo-setting synthetic resin with an aluminium oxide grit type. The result is an elastic abrasive material with an open structure that is easy to use and provides an even and constant finish. The tex material does not affect the geometrical shape of the work pieces. CP has an increased grinding capacity at higher speeds. This material provides the brush structure with a slightly glossy effect.

diameter	centre hole	shape	grit	code	stock	
Ø 200	Ø 25	S203	CP	TMA/CP/S203		10
Ø 250	Ø 25	S207	CP	TMA/CP/S207		10
Ø 300	Ø 25	S302	CP	TMA/CP/S302		10







Tex discs with centre holes

00

application	backing	weight	grit type	coating	waterproof
	Nylon web	–	talc	–	

Grit range: no grit

Description: With the TEX 00, the nylon fibres are combined into a three-dimensional web structure using thermo-setting synthetic resin without abrasive grit. This material does not scratch and is ideally suited for cleaning.



diameter	centre hole	shape	grit	code	stock	
Ø 200	Ø 25	S203	00	TMA/00/S203		10
Ø 250	Ø 25	S207	00	TMA/00/S207		10
Ø 300	Ø 25	S302	00	TMA/00/S302		10

TEX

TALC



CSD

application	backing	weight	grit type	coating	waterproof
	Nylon web	–	S/C	–	

Grit range: EXTRA COARSE

Description: CSD material is made from very hard, abrasion-resistant nylon fibres with a very open structure. The nylon fibres are permeated with synthetic resin and very sharp grit.

TEX

S/C



 **Dimensions:** see p. 329



 = available from stock

 = available in 5 working days

 = on request

> Floorpads

-

TEX



! Floorpad colour codes

- Black = stripping
- Brown = stripping & scrubbing
- Green = scrubbing
- Blue = cleaning
- Red = polishing
- White = polishing

NYLON FLOORPADS

application	backing	weight	grit type	coating	waterproof
	Nylon web	-	-	-	

Grit range: Blue-Brown-Green-Red-White-Black

Description: Floorpads are made from technical nylon fibers and are characterised by an extra open web structure. Each colour stands for specific qualifications concerning the coarseness of the disc, the diameter of the nylon fiber and the grit size.

Thanks to their sophisticated architecture the Cibo floorpads give a faster result, they last longer and they hold their form significantly better.

diameter	code	description	stock	
Ø 400	PADS-ZWART-16"	black	●	5
	PADS-BRUIN-16"	brown	●	5
	PADS-GROEN-16"	green	●	5
	PADS-BLAUW-16"	blue	●	5
	PADS-ROOD-16"	red	●	5
	PADS-WIT-16"	white	●	5
Ø 430	PADS-ZWART-17"	black	●	5
	PADS-BRUIN-17"	brown	●	5
	PADS-GROEN-17"	green	●	5
	PADS-BLAUW-17"	blue	●	5
	PADS-ROOD-17"	red	●	5
	PADS-WIT-17"	white	●	5

Reinforced Tex discs without centre holes

FE							
application			backing	weight	grit type	coating	waterproof
			Nylon web + Polyester	–	A/O	–	
Grit range: COARSE - MEDIUM - VERY FINE							
Description: This is an open nylon web structure, permeated with aluminium oxide grit and anchored by a synthetic resin on a woven polyester structure. This quality is better able to cope with aggressive applications and has a long life span. The finish of the FE quality is less uniform than that of the RC quality.							
diameter	centre hole	shape	grit	code	code back-up pad	stock	
Ø 115	0	S104	CO	VTZA/FE1/S104	115VELSC		20
			ME	VTZA/FE2/S104			20
			VF	VTZA/FE3/S104			20
Ø 125	0	S105	CO	VTZA/FE1/S105	125VELSC		20
			ME	VTZA/FE2/S105			20
			VF	VTZA/FE3/S105			20

SURF. COND.

A/O



RC							
application			backing	weight	grit type	coating	waterproof
			Nylon web + Polyester	–	A/O	–	
Grit range: COARSE - MEDIUM - VERY FINE							
Description: This is an open nylon web structure, permeated with aluminium oxide grit and anchored by a synthetic resin on a woven polyester structure. This material has a high initial cutting force, works perfectly at low pressure and provides a very constant and even finish. The RC is less edge resistant. Ideal for applications requiring a decorative finish.							
diameter	centre hole	shape	grit	code	code back-up pad	stock	
Ø 115	Ø 0	S104	CO	VTZA/RC1/S104	115VELSC		20
			ME	VTZA/RC2/S104			20
			VF	VTZA/RC3/S104			20
Ø 125	Ø 0	S105	CO	VTZA/RC1/S105	125VELSC		20
			ME	VTZA/RC2/S105			20
			VF	VTZA/RC3/S105			20

SURF. COND.

A/O



Additional information about the back-up pads is available in the accessories chapter.

= available from stock

= available in 5 working days

= on request

Reinforced Tex discs with centre holes

A/O

SURF. COND.



FE

application		backing		weight	grit type	coating	waterproof
		Nylon web + Polyester		-	A/O	-	
Grit range:		COARSE - MEDIUM - VERY FINE					
Description:		This is an open nylon web structure, permeated with aluminium oxide grit and anchored by a synthetic resin on a woven polyester structure. This quality is better able to cope with aggressive applications and has a long life span. The finish of the FE quality is less uniform than that of the RC quality.					
diameter	centre hole	shape	grit	code	code back-up pad	stock	
Ø 115	Ø 10	S107	CO	VTMA/FE1/S107	115VELSCN		20
			ME	VTMA/FE2/S107			20
			VF	VTMA/FE3/S107			20
Ø 125	Ø 10	S109	CO	VTMA/FE1/S109	125VELSCN		20
			ME	VTMA/FE2/S109			20
			VF	VTMA/FE3/S109			20

A/O

SURF. COND.



RC

application		backing		weight	grit type	coating	waterproof
		Nylon web + Polyester		-	A/O	-	
Grit range:		COARSE - MEDIUM - VERY FINE					
Description:		This is an open nylon web structure, permeated with aluminium oxide grit and anchored by a synthetic resin on a woven polyester structure. This material has a high initial cutting force, works perfectly at low pressure and provides a very constant and even finish. The RC is less edge resistant. Ideal for applications requiring a decorative finish.					
diameter	centre hole	shape	grit	code	code back-up pad	stock	
Ø 115	Ø 10	S107	CO	VTMA/RC1/S107	115VELSCN		20
			ME	VTMA/RC2/S107			20
			VF	VTMA/RC3/S107			20
Ø 125	Ø 10	S109	CO	VTMA/RC1/S109	125VELSCN		20
			ME	VTMA/RC2/S109			20
			VF	VTMA/RC3/S109			20



Additional information about the back-up pads is available in the Accessories chapter.

> Abrasive stars

RC						
application	backing	weight	grit type	coating	waterproof	
	Nylon web + Polyester	-	A/O	-		
Grit range: COARSE - MEDIUM - VERY FINE						
Description: This is an open nylon web structure, permeated with aluminium oxide grit and anchored by a synthetic resin on a woven polyester structure. This material has a high initial cutting force, works perfectly at low pressure and provides a very constant and even finish. The RC is less edge resistant. Ideal for applications requiring a decorative finish.						
diameter	centre hole	grit	code	code attachment	stock	
Ø 50	Ø 6	CO	VTS/RC1/2	MHS2		50
		ME	VTS/RC2/2			50
		VF	VTS/RC3/2			50
Ø 75	Ø 6	CO	VTS/RC1/3			25
		ME	VTS/RC2/3			25
		VF	VTS/RC3/3			25
Ø 100	Ø 6	CO	VTS/RC1/4			25
		ME	VTS/RC2/4			25
		VF	VTS/RC3/4			25

SURF. COND.

A/O



Please consult Cibo for additional sizes, quality or grit.



= available from stock

= available in 5 working days

= on request

> Reinforced Tex fibre discs

A/O SURF. COND.



RC

application	backing	weight	grit type	coating	waterproof
	Nylonweb + Polyester	-	A/O	-	

Grit range: COARSE - MEDIUM - VERY FINE

Description: This is an open nylon web structure, permeated with aluminium oxide grit and anchored by a synthetic resin on a woven polyester structure. This material has a high initial cutting force, works perfectly at low pressure and provides a very constant and even finish. The RC is less edge resistant. Ideal for applications requiring a decorative finish.

diameter	centre hole	shape	grit	code	code fiberback-up pad	stock	
Ø 115	Ø 22	S120	CO	VTFA/RC1/S120	FIZ115		20
			ME	VTFA/RC2/S120			20
			VF	VTFA/RC3/S120			20
Ø 125	Ø 22	S121	CO	VTFA/RC1/S121	FIZ125		20
			ME	VTFA/RC2/S121			20
			VF	VTFA/RC3/S121			20
Ø 180	Ø 22	S117	CO	VTFA/RC1/S117	FIZ178		10
			ME	VTFA/RC2/S117			10
			VF	VTFA/RC3/S117			10

To be attached on a back-up pad for fibre discs. (see also p. 476)

> Reinforced Tex grip discs

T00 SURF. COND.



T00

application	backing	weight	grit type	coating	waterproof
	Nylonweb + Polyester	-	T00	-	

Grit range: no grit



Description: This is an open nylon web structure, permeated with talc and anchored with a synthetic resin on a woven polyester structure. This quality has no abrasive properties and is specially designed to clean or polish using polishing pastes.

diameter	centre hole	shape	grit	code	code back-up pad	stock	
Ø 115	0	S104	T00	VTGR/T00/S104	115VELSUPERXM		10

Please consult Cibo for additional sizes, quality or grit.













Unitized

SAGR

application	backing	weight	grit type	coating	waterproof
	Nylon web	–	A/O - S/C	–	

Grit range: 5 - 6 - 7 - 8

Description: Pressed abrasives consist of several layers of impregnated brushed nylon fabric, ingeniously glued together and hot-pressed into solid sheets with a controlled density, from which disks and wheels can be punched. They combine good cutting performance with a high-quality finish and enable you very quickly to remove heat tints, to improve the surface smoothness of the workpiece, etc.

diameter	density	shape	code	code back-up pad	stock	
Ø 115	5 - soft	S104	SAGR/5/S104	115VELSUPERXM		5
	6 - medium		SAGR/6/S104			5
	7 - medium		SAGR/7/S104			5
	8 - hard		SAGR/8/S104			5
Ø 125	5 - soft	S105	SAGR/5/S105	125VELSUPERXM		5
	6 - medium		SAGR/6/S105			5
	7 - medium		SAGR/7/S105			5
	8 - hard		SAGR/8/S105			5
Ø 150	5 - soft	S106	SAGR/5/S106	150VELSUPERXM		5
	6 - medium		SAGR/6/S106			5
	7 - medium		SAGR/7/S106			5
	8 - hard		SAGR/8/S106			5

UNITIZED

A/O - S/C

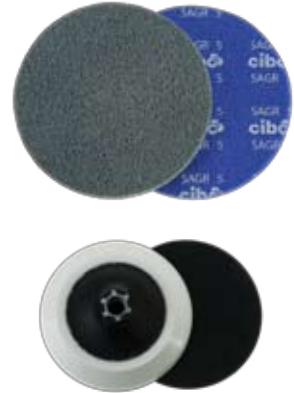



Cibo has succeeded in anchoring unitized material onto a velcro backing. This flexible backing, in combination with a flexible back-up pad, makes the SAGR disc ideal for finishing flat surfaces.



Make sure your work piece has always cooled sufficiently prior to working it with unitized materials. Too much heat generation can cause the material to melt, and thus to lose its superior properties.



 = available from stock

 = available in 5 working days

 = on request

SHEETS

● Overview table	188
● Cutting shapes	200
○ Deltas grip	200
○ Sheets grip	202
○ Sheets with PSA fixing	204
○ Sheets for parquet industry	204
● Film	205
○ Grip sheets	205
○ Aluminium oxide	205
○ Delta grip sheets	206
○ Aluminium oxide	206
● Paper	207
○ Grip sheets	207
○ Aluminium oxide	207
○ Delta grip sheets	210
○ Aluminium oxide	210
○ Sheets	212
○ Aluminium oxide	212
○ Zirconium oxide	214
○ Silicon carbide	215
○ Waterproof sheets	217
○ Aluminium oxide	217
○ Silicon carbide	218
● Cloth	219
○ Sheets	219
○ Aluminium oxide	219
○ Micro-Mesh	220



Cibo can also rapidly manufacture any sizes, grades or grit types that are not listed in the overview.

After all, customisation is the norm at Cibo.

● Mesh	221
○ Sheets	221
○ Silicon carbide	221
● Tex	221
○ Sheets	221
○ Aluminium oxide	221
○ Silicon carbide	222
○ CP	222
○ GP	223
○ 00	223

SHEETS



OVERVIEW

The size of the sheets, the material and the shape will vary depending on the application for which you want to use them. The table below provides an overview of the abrasive materials recommended by Cibo for the various applications. If you want to attach the sheets to a machine, it will determine the shape, the dimensions and the number of holes. Cibo has a wide range of cutting forms available allowing them to produce the sheets you require. You will find an overview of the most important cutting shapes from page 200 onwards.

Application		Type	Backing	Weight	Type of grit	Top Coating	Waterproof	Maximum width	Grit type
Metal 	Cloth	TF41	Cotton	F	A/O	–	–	1420	36-40-50-60-80-100-120-150-180-220-240-280-320
		TF50	Cotton	F	A/O	–	–	1420	40-60-80-100-120-150-180-220-240-280-320-400-500-800
	Tex	A/O	Nylon web	–	A/O	–	💧	1500	A-Coarse - A-Medium - A-Fine - A-Very Fine STRONG - A-Very Fine SOFT - A-Very Fine SUPERSOFT
		CP	Nylon web	–	A/O CP	–	💧	610	CP
Stainless steel 	Paper	KP950F	Paper	F	ZIRC.	–	–	1450	40-60-80-100-120-150-180-220
	Cloth	TF41	Cotton	F	A/O	–	–	1420	36-40-50-60-80-100-120-150-180-220-240-280-320
		TF50	Cotton	F	A/O	–	–	1420	40-60-80-100-120-150-180-220-240-280-320-400-500-800
		MFR	Cotton	F	cali-brated A/O	–	💧*	500	MFR1500 (P800)-MFR1800 (P1200)-MFR2400 (P1500)-MFR3200 (P3000)-MFR3600 (P3500)-MFR4000 (P4000)-MFR6000 (P5000)-MFR8000 (P6500)-MFR12000 (P8000)
		MFX	Cotton	J	cali-brated A/O	–	💧*	500	MFX180 (P600)-MFX240 (P1200)-MFX320 (P1500)-MFX400 (P3500)-MFX600 (P4000)-MFX800 (P5000)-MFX1200 (P6500)

(*) Micro-mesh achieves the best results provided a light mist is used. The use of an excessive amount of water is not recommended with Micro-mesh.











USE OF THE TABLE

Simply look at the material you want to work on, select one of the abrasive materials recommended by Cibo and you will very simply be referred to the page where you can find the necessary sheet. On this page you will also find the most frequently used grit types and cutting forms.

However, customisation is also the norm at Cibo. If you require a cutting shape that is not displayed in the table, please do not hesitate to contact Cibo. We can manufacture the sheets for you very quickly.





Take note: this table only shows the qualities that Cibo feels are the most suitable for a specific application. Should you require a broader overview, please return to the comprehensive overview of the available basic materials on page 58.

Properties	Page
Very flexible abrasive cloth, for manual use in metal working. Also a perfect partner for grinding hard wood types.	219
High-quality, very flexible abrasive cloth for general manual use in metal working. Also a perfect partner for grinding hard wood types.	219
The nylon fibres are combined into a three-dimensional web structure using thermo-setting synthetic resin, and are available in various grit types with an aluminium oxide grit. The result is an elastic abrasive material with an open structure that is easy to use and provides an even and constant finish. The tex material does not affect the geometrical shape of the work pieces. A/O creates a good long-lasting finish at high speeds.	221
The nylon fibres are combined into a three-dimensional web structure using thermo-setting synthetic resin with an aluminium oxide grit type. The result is an elastic abrasive material with an open structure that is easy to use and provides an even and constant finish. The tex material does not affect the geometrical shape of the work pieces. CP has an increased grinding capacity at higher speeds. This material provides the brush structure with a slightly glossy effect.	222
Zirconium oxide grain on an "F" paper base. This product is ideally suited for grinding very hard and dry woods because of the extremely abrasive-resistant zirconium oxide grit. The KP950F is also highly efficient when using stainless steel.	214
Very flexible abrasive cloth, for manual use in metal working. Also a perfect partner for grinding hard wood types.	219
High-quality, very flexible abrasive cloth for general manual use in metal working. Also a perfect partner for grinding hard wood types.	219
Micro-Mesh is a concept whereby extremely precisely calibrated grit crystals are bonded with a flexible glue on a supple cotton base. Due to the elastic positioning, this grit always comes in contact with the workpiece at a positive angle. This ensures a constant and even scratch depth. This ingeniously thought out design guarantees an extremely even, constant and precise finishing pattern.	220
Micro-Mesh is a concept whereby extremely precisely calibrated grit crystals are bonded with a flexible glue on a supple cotton base. Due to the elastic positioning, this grit always comes in contact with the workpiece at a positive angle. This ensures a constant and even scratch depth. This ingeniously thought out design guarantees an extremely even, constant and precise finishing pattern.	220



Application		Type	Backing	Weight	Type of grit	Top Coating	Waterproof	Maximum width	Grit type
Stainless steel 	Tex	A/O	Nylon web	–	A/O	–		1500	A-Coarse - A-Medium - A-Fine - A-Very Fine STRONG - A-Very Fine SOFT - A-Very Fine SUPERSOFT
		S/C	Nylon web	–	S/C	–		1500	S-Medium - S-Fine - S-Very Fine - S-Ultra Fine 600 - S-Ultra Fine 1000 - S-Ultra Fine 1200
		CP	Nylon web	–	A/O CP	–		610	CP
High-quality alloys 	Cloth	TF41	Cotton	F	A/O	–	–	1420	36-40-50-60-80-100-120-150-180-220-240-280-320
		TF50	Cotton	F	A/O	–	–	1420	40-60-80-100-120-150-180-220-240-280-320-400-500-800
		MFR	Cotton	F	cali-brated A/O	–		500	MFR1500 (P800)-MFR1800 (P1200)-MFR2400 (P1500)-MFR3200 (P3000)-MFR3600 (P3500)-MFR4000 (P4000)-MFR6000 (P5000)-MFR8000 (P6500)-MFR12000 (P8000)
		MFX	Cotton	J	cali-brated A/O	–		500	MFX180 (P600)-MFX240 (P1200)-MFX320 (P1500)-MFX400 (P3500)-MFX600 (P4000)-MFX800 (P5000)-MFX1200 (P6500)
	Tex	S/C	Nylon web	–	S/C	–		1500	S-Medium - S-Fine - S-Very Fine - S-Ultra Fine 600 - S-Ultra Fine 1000 - S-Ultra Fine 1200
Non-ferrous 	Cloth	TF41	Cotton	F	A/O	–	–	1420	36-40-50-60-80-100-120-150-180-220-240-280-320
		TF50	Cotton	F	A/O	–	–	1420	40-60-80-100-120-150-180-220-240-280-320-400-500-800
	Tex	S/C	Nylon web	–	S/C	–		1500	S-Medium - S-Fine - S-Very Fine - S-Ultra Fine 600 - S-Ultra Fine 1000 - S-Ultra Fine 1200

(*) Micro-mesh achieves the best results provided a light mist is used. The use of an excessive amount of water is not recommended with Micro-mesh.













Properties	Page
The nylon fibres are combined into a three-dimensional web structure using thermo-setting synthetic resin, and are available in various grit types with an aluminium oxide grit. The result is an elastic abrasive material with an open structure that is easy to use and provides an even and constant finish. The tex material does not affect the geometrical shape of the work pieces. A/O creates a good long-lasting finish at high speeds.	221
The nylon fibres are combined into a three-dimensional web structure using thermo-setting synthetic resin, and are available in various grit sizes with silicon carbide grit. The result is an elastic abrasive material with an open structure that is easy to use and provides an even and constant finish. The tex material does not affect the geometrical shape of the work pieces. In comparison with the A/O, S/C provides a finer, more even and matt texture. Primarily used to create a decorative finish.	222
The nylon fibres are combined into a three-dimensional web structure using thermo-setting synthetic resin with an aluminium oxide grit type. The result is an elastic abrasive material with an open structure that is easy to use and provides an even and constant finish. The tex material does not affect the geometrical shape of the work pieces. CP has an increased grinding capacity at higher speeds. This material provides the brush structure with a slightly glossy effect.	222
Very flexible abrasive cloth, for manual use in metal working. Also a perfect partner for grinding hard wood types.	219
High-quality, very flexible abrasive cloth for general manual use in metal working. Also a perfect partner for grinding hard wood types.	219
Micro-Mesh is a concept whereby extremely precisely calibrated grit crystals are bonded with a flexible glue on a supple cotton base. Due to the elastic positioning, this grit always comes in contact with the workpiece at a positive angle. This ensures a constant and even scratch depth. This ingeniously thought out design guarantees an extremely even, constant and precise finishing pattern.	220
Micro-Mesh is a concept whereby extremely precisely calibrated grit crystals are bonded with a flexible glue on a supple cotton base. Due to the elastic positioning, this grit always comes in contact with the workpiece at a positive angle. This ensures a constant and even scratch depth. This ingeniously thought out design guarantees an extremely even, constant and precise finishing pattern.	220
The nylon fibres are combined into a three-dimensional web structure using thermo-setting synthetic resin, and are available in various grit sizes with silicon carbide grit. The result is an elastic abrasive material with an open structure that is easy to use and provides an even and constant finish. The tex material does not affect the geometrical shape of the work pieces. In comparison with the A/O, S/C provides a finer, more even and matt texture. Primarily used to create a decorative finish.	222
Very flexible abrasive cloth, for manual use in metal working. Also a perfect partner for grinding hard wood types.	219
High-quality, very flexible abrasive cloth for general manual use in metal working. Also a perfect partner for grinding hard wood types.	219
The nylon fibres are combined into a three-dimensional web structure using thermo-setting synthetic resin, and are available in various grit sizes with silicon carbide grit. The result is an elastic abrasive material with an open structure that is easy to use and provides an even and constant finish. The tex material does not affect the geometrical shape of the work pieces. In comparison with the A/O, S/C provides a finer, more even and matt texture. Primarily used to create a decorative finish.	222

Application		Type	Backing	Weight	Type of grit	Top Coating	Waterproof	Maximum width	Grit type
Aluminium 	Paper	SP717C	Paper	C	S/C	–		ONLY IN SHEET FORM	60-80-100-120-150-180-220-240-280-320-360-400-500-600-800-1000-1200-1500-2000-2500
	Cloth	TF41	Cotton	F	A/O	–	–	1420	36-40-50-60-80-100-120-150-180-220-240-280-320
		TF50	Cotton	F	A/O	–	–	1420	40-60-80-100-120-150-180-220-240-280-320-400-500-800
	Tex	S/C	Nylon web	–	S/C	–		1500	S-Medium - S-Fine - S-Very Fine - S-Ultra Fine 600 - S-Ultra Fine 1000 - S-Ultra Fine 1200
Hard wood 	Paper	KP905E	Paper	E	A/O	–	–	1450	40-60-80-100-120-150-180-220
		KP947F	Paper	F	A/O	–	–	1450	240-280-320-400
		KP949FO	Paper	F	A/O	–	–	1450	Grip: 40-60-80-100-120-150-180-220 Without grip: 36-40-50-60-80-100-120-150-180-220
		KP950F	Paper	F	ZIRC.	–	–	1450	40-60-80-100-120-150-180-220
		SP706F	Paper	F	S/C	–	–	1450	Grip: 24-36-40-60-80-100-120-220-320-400-500-600-800-1000-1200 Without grip: 24-36-40-50-60-80-100-120-150-180-220-240-280-320-400-500-600-800-1000-1200
		LKE22	Combina- tion	–	S/C	–	–	1350	16-20
	Cloth	TF41	Cotton	F	A/O	–	–	1420	36-40-50-60-80-100-120-150-180-220-240-280-320
		TF50	Cotton	F	A/O	–	–	1420	40-60-80-100-120-150-180-220-240-280-320-400-500-800
	Tex	A/O	Nylon web	–	A/O	–		1500	A-Coarse - A-Medium - A-Fine - A-Very Fine STRONG - A-Very Fine SOFT - A-Very Fine SUPERSOFT

Properties	Page
High-quality and very flexible waterproof sandpaper with a silicon carbide grit type. The base consists of a flexible, easily pliable latex backing with "C" weight. Primarily for applications in the auto industry and auto repair shops.	218
Very flexible abrasive cloth, for manual use in metal working. Also a perfect partner for grinding hard wood types.	219
High-quality, very flexible abrasive cloth for general manual use in metal working. Also a perfect partner for grinding hard wood types.	219
The nylon fibres are combined into a three-dimensional web structure using thermo-setting synthetic resin, and are available in various grit sizes with silicon carbide grit. The result is an elastic abrasive material with an open structure that is easy to use and provides an even and constant finish. The tex material does not affect the geometrical shape of the work pieces. In comparison with the A/O, S/C provides a finer, more even and matt texture. Primarily used to create a decorative finish.	222
Antistatic, aluminium oxide on a strong "E" backing. Specially developed with a heavier, less tear-resistant backing for heavier, manual work and for applications on light manual grinding machines.	214
Antistatic, closed coated aluminium oxide on a very strong "F" paper base. The antistatic property ensures the easy removal of dust . The KP947F is a product that can be used for various purposes. Perfect grade for both dry and hard woods as well as for those of a softer quality with a higher level of resin.	214
Antistatic, semi-open coated aluminium oxide on a very strong "F" paper base. The antistatic property ensures the easy removal of dust . The KP949FO is a product that can be used for various purposes. Perfect grade for both dry and hard woods as well as for those of a softer quality with a higher level of resin.	from 209
Zirconium oxide grain on an "F" paper base. This product is ideally suited for grinding very hard and dry woods because of the extremely abrasive-resistant zirconium oxide grit. The KP950F is also highly efficient when using stainless steel.	214
Antistatic silicon carbide grit on a very strong "F" base. Ideally suited for use in sanding wooden floors and parquet.	215
Combination abrasive material. A heavy F paper reinforced with a light fabric and provided with a very open silicon carbide grit structure. Primarily for use in sanding old and dirty wooden floors and parquet. Also suitable for removing old paint, glue and varnish layers or carpet remains.	216
Very flexible abrasive cloth, for manual use in metal working. Also a perfect partner for grinding hard wood types.	219
High-quality, very flexible abrasive cloth for general manual use in metal working. Also a perfect partner for grinding hard wood types.	219
The nylon fibres are combined into a three-dimensional web structure using thermo-setting synthetic resin, and are available in various grit types with an aluminium oxide grit. The result is an elastic abrasive material with an open structure that is easy to use and provides an even and constant finish. The tex material does not affect the geometrical shape of the work pieces. A/O creates a good long-lasting finish at high speeds.	221











Application		Type	Backing	Weight	Type of grit	Top Coating	Waterproof	Maximum width	Grit type
Soft wood 	Paper	SA331	Film	–	A/O	●	💧	1350	Grip: 40-60-80-100-120-150-180-220-320-400-600-800-1200 Without grip: 80-120-320-400
		CA330	Paper	C	A/O	●	–	1350	Grip: 60-80-100-120-150-180-220-240-320-400-500-600 Without grip: 60-80-100-120-150-180-220-320-400-500-600
		KP905E	Paper	E	A/O	–	–	1450	40-60-80-100-120-150-180-220
		KP947F	Paper	F	A/O	–	–	1450	240-280-320-400
		KP949FO	Paper	F	A/O	–	–	1450	Grip: 40-60-80-100-120-150-180-220 Without grip: 36-40-50-60-80-100-120-150-180-220
		SP706F	Paper	F	S/C	–	–	1450	Grip: 24-36-40-60-80-100-120-220-320-400-500-600-800-1000-1200 Without grip: 24-36-40-50-60-80-100-120-150-180-220-240-280-320-400-500-600-800-1000-1200
		LKE22	Combina- tion	–	S/C	–	–	1350	16-20
	Cloth	QNSH	mesh	–	S/C	–	💧	910	40-60-80-100-120-150-180-220-320-400-500-600
Tex	A/O	Nylon web	–	A/O	–	💧	1500	A-Coarse - A-Medium - A-Fine - A-Very Fine STRONG - A-Very Fine SOFT - A-Very Fine SUPERSOFT	
Glass & stone 	Paper	SP717C	Paper	C	S/C	–	💧	ONLY IN SHEET FORM 60-80-100-120-150-180-220-240-280-320-360-400-500-600-800-1000-1200-1500-2000-2500	
		SP706F	Paper	F	S/C	–	–	1450	Grip: 24-36-40-60-80-100-120-220-320-400-500-600-800-1000-1200 Without grip: 24-36-40-50-60-80-100-120-150-180-220-240-280-320-400-500-600-800-1000-1200
	Tex	00	Nylon web	–	OO	–	💧	1500	No grit

Properties	Page
Open coated aluminium oxide grit with an active abrasive ingredient on a film backing. Extremely tear-resistant. Does not clog up, long life span, extremely large grit size range. Can be used for many purposes, especially with more intensive grinding operations. Ideal for finishing of soft wood types and car repair, paints, lacquers and varnishes. Used both wet and dry.	205
Open coated aluminium oxide with grinding aid on flexible "C" paper. Very pliable and flexible, cannot saturate, adapts easily to the workpiece and guarantees a beautiful, even finish. Ideal for grinding primary coats, primers, sealers, lacquers, paint, varnish, filler and wood.	from 207
Antistatic, aluminium oxide on a strong "E" backing. Specially developed with a heavier, less tear-resistant backing for heavier, manual work and for applications on light manual grinding machines.	214
Antistatic, closed coated aluminium oxide on a very strong "F" paper base. The antistatic property ensures the easy removal of dust. The KP947F is a product that can be used for various purposes. Perfect grade for both dry and hard woods as well as for those of a softer quality with a higher level of resin.	214
Antistatic, semi-open coated aluminium oxide on a very strong "F" paper base. The antistatic property ensures the easy removal of dust. The KP949FO is a product that can be used for various purposes. Perfect grade for both dry and hard woods as well as for those of a softer quality with a higher level of resin.	from 209
Antistatic silicon carbide grit on a very strong "F" base. Ideally suited for use in sanding wooden floors and parquet.	215
Combination abrasive material. A heavy F paper reinforced with a light fabric and provided with a very open silicon carbide grit structure. Primarily for use in sanding old and dirty wooden floors and parquet. Also suitable for removing old paint, glue and varnish layers or carpet remains.	216
Open polyester web structure to which grits are anchored on both sides.	221
The nylon fibres are combined into a three-dimensional web structure using thermo-setting synthetic resin, and are available in various grit types with an aluminium oxide grit. The result is an elastic abrasive material with an open structure that is easy to use and provides an even and constant finish. The tex material does not affect the geometrical shape of the work pieces. A/O creates a good long-lasting finish at high speeds.	221
High-quality and very flexible waterproof sandpaper with a silicon carbide grit type. The base consists of a flexible, easily pliable latex backing with "C" weight. Primarily for applications in the auto industry and auto repair shops.	218
Antistatic silicon carbide grit on a very strong "F" base. Ideally suited for use in sanding wooden floors and parquet.	215
With the TEX 00, the nylon fibres are combined into a three-dimensional web structure using thermo-setting synthetic resin without abrasive grit. This material does not scratch and is ideally suited for cleaning.	223

Application		Type	Backing	Weight	Type of grit	Top Coating	Waterproof	Maximum width	Grit type
Plastic & Rubber 	Paper	SP717C	Paper	C	S/C	–		ONLY IN SHEET FORM	60-80-100-120-150-180-220-240-280-320-360-400-500-600-800-1000-1200-1500-2000-2500
	Cloth	MFR	Cotton	F	calibrated A/O	–		500	MFR1500 (P800)-MFR1800 (P1200)-MFR2400 (P1500)-MFR3200 (P3000)-MFR3600 (P3500)-MFR4000 (P4000)-MFR6000 (P5000)-MFR8000 (P6500)-MFR12000 (P8000)
		MFX	Cotton	J	calibrated A/O	–		500	MFX180 (P600)-MFX240 (P1200)-MFX320 (P1500)-MFX400 (P3500)-MFX600 (P4000)-MFX800 (P5000)-MFX1200 (P6500)
	Tex	S/C	Nylon web	–	S/C	–		1500	S-Medium - S-Fine - S-Very Fine - S-Ultra Fine 600 - S-Ultra Fine 1000 - S-Ultra Fine 1200
Car repair 	Paper	SA331	Film	–	A/O			1350	Grip: 40-60-80-100-120-150-180-220-320-400-600-800-1200 Without grip: 80-120-320-400
		CA330	Paper	C	A/O		–	1350	Grip: 60-80-100-120-150-180-220-240-320-400-500-600 Without grip: 60-80-100-120-150-180-220-320-400-500-600
		KP915C	Paper	C	A/O	–		ONLY IN SHEET FORM	60-80-100-120-150-180-220-240-280-320-360-400-500-600-800-1000-1200
		SP717C	Paper	C	S/C	–		ONLY IN SHEET FORM	60-80-100-120-150-180-220-240-280-320-360-400-500-600-800-1000-1200-1500-2000-2500
	Cloth	QNSH	Mesh	–	S/C	–		910	40-60-80-100-120-150-180-220-320-400-500-600

(*) Micro-mesh achieves the best results provided a light mist is used. The use of an excessive amount of water is not recommended with Micro-mesh.

Properties	Page
High-quality and very flexible waterproof sandpaper with a silicon carbide grit type. The base consists of a flexible, easily pliable latex backing with "C" weight. Primarily for applications in the auto industry and auto repair shops.	218
Micro-Mesh is a concept whereby extremely precisely calibrated grit crystals are bonded with a flexible glue on a supple cotton base. Due to the elastic positioning, this grit always comes in contact with the workpiece at a positive angle. This ensures a constant and even scratch depth. This ingeniously thought out design guarantees an extremely even, constant and precise finishing pattern.	220
Micro-Mesh is a concept whereby extremely precisely calibrated grit crystals are bonded with a flexible glue on a supple cotton base. Due to the elastic positioning, this grit always comes in contact with the workpiece at a positive angle. This ensures a constant and even scratch depth. This ingeniously thought out design guarantees an extremely even, constant and precise finishing pattern.	220
The nylon fibres are combined into a three-dimensional web structure using thermo-setting synthetic resin, and are available in various grit sizes with silicon carbide grit. The result is an elastic abrasive material with an open structure that is easy to use and provides an even and constant finish. The tex material does not affect the geometrical shape of the work pieces. In comparison with A/O, S/C provides a finer, even and matt line structure. Primarily used to create a decorative finish.	222
Open coated aluminium oxide grit with an active abrasive ingredient on a film backing. Extremely tear-resistant. Does not clog up, long life span, extremely large grit size range. Can be used for many purposes, especially with more intensive grinding operations. Ideal for finishing of soft wood types and car repair, paints, lacquers and varnishes. Used both wet and dry.	205
Open coated aluminium oxide with grinding aid on flexible "C" paper. Very pliable and flexible, cannot saturate, adapts easily to the workpiece and guarantees a beautiful, even finish. Ideal for grinding primary coats, primers, sealers, lacquers, paint, varnish, filler and wood.	from 207
High-quality and very flexible, waterproof sandpaper with aluminium oxide grit. The base consists of a flexible, easily pliable paper latex base with "C" weight. For use in the auto industry and, primarily with wet intermediate grinding of paints, lacquers and varnishes.	217
High-quality and very flexible waterproof sandpaper with a silicon carbide grit type. The base consists of a flexible, easily pliable latex backing with "C" weight. Primarily for applications in the auto industry and auto repair shops.	218
Open polyester web structure to which grits are anchored on both sides.	221

Application		Type	Backing	Weight	Type of grit	Top Coating	Waterproof	Maximum width	Grit type
Car repair 	Tex	A/O	Nylon web	–	A/O	–		1500	A-Coarse - A-Medium - A-Fine - A-Very Fine STRONG - A-Very Fine SOFT - A-Very Fine SUPERSOFT
		S/C		–	S/C	–		1500	S-Medium - S-Fine - S-Very Fine - S-Ultra Fine 600 - S-Ultra Fine 1000 - S-Ultra Fine 1200
		00		–	OO	–		1500	No grit
Lacquer & varnish 	Paper	SA331	Film	–	A/O	●		1350	Grip: 40-60-80-100-120-150-180-220-320-400-600-800-1200 Without grip: 80-120-320-400
		CA330	Paper	C	A/O	●	–	1350	Grip: 60-80-100-120-150-180-220-240-320-400-500-600 Without grip: 60-80-100-120-150-180-220-320-400-500-600
		KP915C	Paper	C	A/O	–		ONLY IN SHEET FORM	60-80-100-120-150-180-220-240-280-320-360-400-500-600-800-1000-1200
		SP717C	Paper	C	S/C	–		ONLY IN SHEET FORM	60-80-100-120-150-180-220-240-280-320-360-400-500-600-800-1000-1200-1500-2000-2500
	Tex	A/O	Nylon web	–	A/O	–		1500	A-Coarse - A-Medium - A-Fine - A-Very Fine STRONG - A-Very Fine SOFT - A-Very Fine SUPERSOFT
		S/C		–	S/C	–		1500	S-Medium - S-Fine - S-Very Fine - S-Ultra Fine 600 - S-Ultra Fine 1000 - S-Ultra Fine 1200
		00		–	OO	–		1500	No grit

Properties	Page
The nylon fibres are combined into a three-dimensional web structure using thermo-setting synthetic resin, and are available in various grit types with an aluminium oxide grit. The result is an elastic abrasive material with an open structure that is easy to use and provides an even and constant finish. The tex material does not affect the geometrical shape of the work pieces. A/O creates a good long-lasting finish at high speeds.	221
The nylon fibres are combined into a three-dimensional web structure using thermo-setting synthetic resin, and are available in various grit sizes with silicon carbide grit. The result is an elastic abrasive material with an open structure that is easy to use and provides an even and constant finish. The tex material does not affect the geometrical shape of the work pieces. In comparison with A/O, S/C provides a finer, even and matt line structure. Primarily used to create a decorative finish.	222
With the TEX 00, the nylon fibres are combined into a three-dimensional web structure using thermo-setting synthetic resin without abrasive grit. This material does not scratch and is ideally suited for cleaning.	223
Open coated aluminium oxide grit with an active abrasive ingredient on a film backing. Extremely tear-resistant. Does not clog up, long life span, extremely large grit size range. Can be used for many purposes, especially with more intensive grinding operations. Ideal for finishing of soft wood types and car repair, paints, lacquers and varnishes. Used both wet and dry.	205
Open coated aluminium oxide with grinding aid on flexible "C" paper. Very pliable and flexible, cannot saturate, adapts easily to the workpiece and guarantees a beautiful, even finish. Ideal for grinding primary coats, primers, sealers, lacquers, paint, varnish, filler and wood.	from 207
High-quality and very flexible, waterproof sandpaper with aluminium oxide grit. The base consists of a flexible, easily pliable paper latex base with "C" weight. For use in the auto industry and, primarily with wet intermediate grinding of paints, lacquers and varnishes.	217
High-quality and very flexible waterproof sandpaper with a silicon carbide grit type. The base consists of a flexible, easily pliable latex backing with "C" weight. Primarily for applications in the auto industry and auto repair shops.	218
The nylon fibres are combined into a three-dimensional web structure using thermo-setting synthetic resin, and are available in various grit types with an aluminium oxide grit. The result is an elastic abrasive material with an open structure that is easy to use and provides an even and constant finish. The tex material does not affect the geometrical shape of the work pieces. A/O creates a good long-lasting finish at high speeds.	221
The nylon fibres are combined into a three-dimensional web structure using thermo-setting synthetic resin, and are available in various grit sizes with silicon carbide grit. The result is an elastic abrasive material with an open structure that is easy to use and provides an even and constant finish. The tex material does not affect the geometrical shape of the work pieces. In comparison with A/O, S/C provides a finer, even and matt line structure. Primarily used to create a decorative finish.	222
With the TEX 00, the nylon fibres are combined into a three-dimensional web structure using thermo-setting synthetic resin without abrasive grit. This material does not scratch and is ideally suited for cleaning.	223

OVERVIEW OF MAIN CUTTING SHAPES

The shape of the sheets will vary according to the shape of the attachment on your machine and the way the sheets are attached to the machine. Cibo has an entire range of cutting shapes that can be used to cut the sheets out of the basic material. The following pages contain an overview of the available cutting shapes. Cibo can very quickly produce new cutting shapes for you, in addition to those displayed.

Do you find it difficult to figure out the specific cutting shape you need? Fax or send us a copy of a sheet that you still have lying around and we will find out for you.

Tel. : +32 (0) 16 61 85 85 – Fax: +32 (0) 16 61 84 84 – E-mail: info@cibo.be

> Deltas grip

DELTA GRIP













shape	length	width	holes	code
	55	40	0	D003
	70	70	0	D005
	80	80	0	D001
	90	50	0	D007
	95	50	0	D004
	95	95	6	DP01
	95	95	6	DP02
	100	60	0	D006
	100	65	0	D002
	102	62	5	DP09

>>

shape	length	width	holes	code
	105	105	6	DP03
	120	120	6	DP07
	125	70	6	DP05
	140	100	5	DP10
	150	102	7	DP04
	150	102	7	DP11
	173	100	8	DP06
	185	110	8	DP08









> Sheets grip

SHEETS GRIP

shape	length	width	holes	code
	60	40	0	V000
	115	102	6	VP01
	115	102	6	VP25
	115	112	8	VP12
	125	70	0	V001
	133	81	8	VP03
	133	81	4+4	VP02
	153	81	8	VP04
	165	90	6+2	VP24
	178	93	0	V002
	178	93	8	VP05
	178	93	10	VP07







>>

shape	length	width	holes	code
	186	93	8	VP06
	200	75	11	VP13
	205	68	6	VP15
	205	70	6	VP18
	215	110	6+2	VP09
	230	115	0	V003
	230	115	10	VP08
	420	70	14	VP16

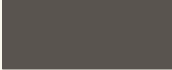

> Sheets with PSA fixing

SHEETS WITH PSA FIXING

shape	length	width	holes	code
	230	93	0	V005
	230	93	6+2	VP14
	230	93	8	VP11
	280	115	0	V004
	280	115	10	VP10

> Sheets for the parquet industry

SHEETS FOR THE PARQUET INDUSTRY

shape	length	width	holes
	475	200	0
	560	200	0
	685	200	0



For other dimensions, qualities or grits: contact Cibo.

> Film grip sheets

SA331

FILM

A/O

application	backing	weight	grit type	coating	waterproof
	Film	-	A/O	●	💧

Grit range: 40-60-80-100-120-150-180-220-320-400-600-800-1200

Description: Open coated aluminium oxide grit with an active abrasive ingredient on a film backing. Extremely tear-resistant. Does not clog up, long life span, extremely large grit size range. Can be used for many purposes, especially with more intensive grinding operations. Ideal for finishing of soft wood types and car repair, paints, lacquers and varnishes. Used both wet and dry.

L x W	holes	shape	grit	code	stock	
125X70	0	V001	40	331GR/40/V001	●	100
	0	V001	60	331GR/60/V001	●	100
	0	V001	80	331GR/80/V001	●	100
	0	V001	100	331GR/100/V001	●	100
	0	V001	120	331GR/120/V001	●	100
	0	V001	150	331GR/150/V001	●	100
	0	V001	180	331GR/180/V001	●	100
	0	V001	220	331GR/220/V001	●	100
	0	V001	320	331GR/320/V001	●	100
	0	V001	400	331GR/400/V001	●	100
	0	V001	500	331GR/500/V001	●	100
	0	V001	600	331GR/600/V001	●	100
	0	V001	800	331GR/800/V001	●	100
133X81	4+4	VP02	40	331GR/40/VP02	●	100
	4+4	VP02	60	331GR/60/VP02	●	100
	4+4	VP02	80	331GR/80/VP02	●	100
	4+4	VP02	100	331GR/100/VP02	●	100
	4+4	VP02	120	331GR/120/VP02	●	100
	4+4	VP02	150	331GR/150/VP02	●	100
	4+4	VP02	180	331GR/180/VP02	●	100
	4+4	VP02	220	331GR/220/VP02	●	100
	4+4	VP02	320	331GR/320/VP02	●	100
	4+4	VP02	400	331GR/400/VP02	●	100
	4+4	VP02	500	331GR/500/VP02	●	100
	4+4	VP02	600	331GR/600/VP02	●	100
	4+4	VP02	800	331GR/800/VP02	●	100



● = available from stock

● = available in 5 working days

● = on request



SA331



L x W	holes	shape	grit	code	stock	
230X115	10	VP08	40	331GR/40/VP08	●	100
	10	VP08	60	331GR/60/VP08	●	100
	10	VP08	80	331GR/80/VP08	●	100
	10	VP08	100	331GR/100/VP08	●	100
	10	VP08	120	331GR/120/VP08	●	100
	10	VP08	150	331GR/150/VP08	●	100
	10	VP08	180	331GR/180/VP08	●	100
	10	VP08	220	331GR/220/VP08	●	100
	10	VP08	320	331GR/320/VP08	●	100
	10	VP08	400	331GR/400/VP08	●	100
	10	VP08	500	331GR/500/VP08	●	100
	10	VP08	600	331GR/600/VP08	●	100
10	VP08	800	331GR/800/VP08	●	100	

> Film delta grip sheets

A/O

FILM

SA331

application	backing	weight	grit type	coating	waterproof
	Film	-	A/O	●	

Grit range: 40-60-80-100-120-150-180-220-320-400-600-800-1200

Description: Open coated aluminium oxide grit with an active abrasive ingredient on a film backing. Extremely tear-resistant. Does not overflow, long life span, extremely large grit size range. Can be used for many purposes, especially with more intensive grinding operations. Ideal for finishes of soft wood types and car repair, paints, lacquers and varnishes. Used both wet and dry.

L x W	holes	shape	grit	code	stock	
80x80	0	D001	60	331GR/60/D001	●	100
	0	D001	80	331GR/80/D001	●	100
	0	D001	120	331GR/120/D001	●	100
95X95	6	DP01	60	331GR/60/DP01	●	100
	6	DP01	80	331GR/80/DP01	●	100
	6	DP01	120	331GR/120/DP01	●	100
150X102	7	DP04	60	331GR/60/DP04	●	100
	7	DP04	80	331GR/80/DP04	●	100
	7	DP04	120	331GR/120/DP04	●	100



➤ Paper grip sheets

PAPER

A/O

CA330

application	backing	weight	grit type	coating	waterproof
	Paper	C	A/O	●	-

Grit range: 60-80-100-120-150-180-220-240-320-400-500-600

Description: Open coated aluminium oxide with grinding aid on flexible "C" paper. Very pliable and flexible, cannot saturate, adapts easily to the workpiece and guarantees a beautiful, even finish. Ideal for grinding primary coats, primers, sealers, lacquers, paint, varnish, filler and wood.

L x W	holes	shape	grit	code	stock	
125X70	0	V001	60	330GR/60/V001	●	100
	0	V001	80	330GR/80/V001	●	100
	0	V001	100	330GR/100/V001	●	100
	0	V001	120	330GR/120/V001	●	100
	0	V001	150	330GR/150/V001	●	100
	0	V001	180	330GR/180/V001	●	100
	0	V001	220	330GR/220/V001	●	100
	0	V001	320	330GR/320/V001	●	100
	0	V001	400	330GR/400/V001	●	100
	0	V001	500	330GR/500/V001	●	100
133X81	8	VP02	60	330GR/60/VP02	●	100
	8	VP02	80	330GR/80/VP02	●	100
	8	VP02	100	330GR/100/VP02	●	100
	8	VP02	120	330GR/120/VP02	●	100
	8	VP02	150	330GR/150/VP02	●	100
	8	VP02	180	330GR/180/VP02	●	100
	8	VP02	220	330GR/220/VP02	●	100
	8	VP02	320	330GR/320/VP02	●	100
	8	VP02	400	330GR/400/VP02	●	100
	8	VP02	500	330GR/500/VP02	●	100
8	VP02	600	330GR/600/VP02	●	100	



>>

● = available from stock

● = available in 5 working days

● = on request



CA330



L x W	holes	shape	grit	code	stock	
230X115	10	VP08	60	330GR/60/VP08	●	100
	10	VP08	80	330GR/80/VP08	●	100
	10	VP08	100	330GR/100/VP08	●	100
	10	VP08	120	330GR/120/VP08	●	100
	10	VP08	150	330GR/150/VP08	●	100
	10	VP08	180	330GR/180/VP08	●	100
	10	VP08	220	330GR/220/VP08	●	100
	10	VP08	320	330GR/320/VP08	●	100
	10	VP08	400	330GR/400/VP08	●	100
	10	VP08	500	330GR/500/VP08	●	100
	10	VP08	600	330GR/600/VP08	●	100



> Paper grip sheets

PAPER

A/O

KP949FO

application	backing	weight	grit type	coating	waterproof
	Paper	F	A/O	-	-

Grit range: 40-60-80-100-120-150-180-220

Description: Antistatic, semi-open coated aluminium oxide on a very strong "F" paper base. The antistatic property ensures the easy removal of dust. The KP949FO is a product that can be used for various purposes. Perfect grade for both dry and hard woods as well as for those of a softer quality with a higher level of resin.

L x W	holes	shape	grit	code	stock	
125X70	0	V001	40	949GR/40/V001	●	100
	0	V001	60	949GR/60/V001	●	100
	0	V001	80	949GR/80/V001	●	100
	0	V001	100	949GR/100/V001	●	100
	0	V001	120	949GR/120/V001	●	100
	0	V001	150	949GR/150/V001	●	100
	0	V001	180	949GR/180/V001	●	100
	0	V001	220	949GR/220/V001	●	100
133X81	8	VP02	40	949GR/40/VP02	●	100
	8	VP02	60	949GR/60/VP02	●	100
	8	VP02	80	949GR/80/VP02	●	100
	8	VP02	100	949GR/100/VP02	●	100
	8	VP02	120	949GR/120/VP02	●	100
	8	VP02	150	949GR/150/VP02	●	100
	8	VP02	180	949GR/180/VP02	●	100
	8	VP02	220	949GR/220/VP02	●	100
230X115	10	VP08	40	949GR/40/VP08	●	100
	10	VP08	60	949GR/60/VP08	●	100
	10	VP08	80	949GR/80/VP08	●	100
	10	VP08	100	949GR/100/VP08	●	100
	10	VP08	120	949GR/120/VP08	●	100
	10	VP08	150	949GR/150/VP08	●	100
	10	VP08	180	949GR/180/VP08	●	100
	10	VP08	220	949GR/220/VP08	●	100



● = available from stock

● = available in 5 working days

● = on request

> Paper delta grip sheets

A/O

PAPER

CA330



application	backing	weight	grit type	coating	waterproof
	Paper	C	A/O	●	–

Grit range: 60-80-100-120-150-180-220-240-320-400-500-600

Description: Open coated aluminium oxide with grinding aid on flexible "C" paper. Very pliable and flexible, cannot saturate, adapts easily to the workpiece and guarantees a beautiful, even finish. Ideal for grinding primary coats, primers, sealers, lacquers, paint, varnish, filler and wood.

L x W	holes	shape	grit	code	stock	
80x80	0	D001	60	330GR/60/D001	●	100
	0	D001	80	330GR/80/D001	●	100
	0	D001	120	330GR/120/D001	●	100
95X95	6	DP01	60	330GR/60/DP01	●	100
	6	DP01	80	330GR/80/DP01	●	100
	6	DP01	120	330GR/120/DP01	●	100
150X102	7	DP04	60	330GR/60/DP04	●	100
	7	DP04	80	330GR/80/DP04	●	100
	7	DP04	120	330GR/120/DP04	●	100



➤ Paper delta grip sheets

PAPER

A/O

KP949FO

application	backing	weight	grit type	coating	waterproof
	Paper	F	A/O	-	-

Grit range: 40-60-80-100-120-150-180-220

Description: Antistatic, semi-open coated aluminium oxide on a very strong "F" paper base. The antistatic property ensures the easy removal of dust. The KP949FO is a product that can be used for various purposes. Perfect grade for both dry and hard woods as well as for those of a softer quality with a higher level of resin.

L x W	holes	shape	grit	code	stock	
80x80	0	D001	60	949GR/60/D001	●	100
	0	D001	80	949GR/80/D001	●	100
	0	D001	120	949GR/120/D001	●	100
95X95	6	DP01	60	949GR/60/DP01	●	100
	6	DP01	80	949GR/80/DP01	●	100
	6	DP01	120	949GR/120/DP01	●	100
150X102	7	DP04	60	949GR/60/DP04	●	100
	7	DP04	80	949GR/80/DP04	●	100
	7	DP04	120	949GR/120/DP04	●	100



For other dimensions, qualities or grits: contact Cibo.



● = available from stock

● = available in 5 working days

● = on request

> Paper sheets

A/O

PAPER

CA330

application	backing	weight	grit type	coating	waterproof
	Paper	C	A/O	●	–

Grit range: 60-80-100-120-150-180-220-320-400-500-600

Description: Open coated aluminium oxide with grinding aid on flexible "C" paper. Very pliable and flexible, cannot saturate, adapts easily to the workpiece and guarantees a beautiful, even finish. Ideal for grinding primary coats, primers, sealers, lacquers, paint, varnish, filler and wood.



L x W	holes	shape	grit	code	stock	
280x230	0	–	60	330/60/280230	●	50
	0	–	80	330/80/280230	●	100
	0	–	100	330/100/280230	●	100
	0	–	120	330/120/280230	●	100
	0	–	150	330/150/280230	●	100
	0	–	180	330/180/280230	●	100
	0	–	220	330/220/280230	●	100
	0	–	320	330/320/280230	●	100
	0	–	400	330/400/280230	●	100
	0	–	500	330/500/280230	●	100
280x115	0	V004	60	330/60/V004	●	100
	0	V004	80	330/80/V004	●	100
	0	V004	100	330/100/V004	●	100
	0	V004	120	330/120/V004	●	100
	0	V004	150	330/150/V004	●	100
	0	V004	180	330/180/V004	●	100
	0	V004	220	330/220/V004	●	100
	0	V004	320	330/320/V004	●	100
	0	V004	400	330/400/V004	●	100
	0	V004	500	330/500/V004	●	100
0	V004	600	330/600/V004	●	100	





CA330

L x W	holes	shape	grit	code	stock	
280x115	10	VP10	60	330/60/VP10	●	100
	10	VP10	80	330/80/VP10	●	100
	10	VP10	100	330/100/VP10	●	100
	10	VP10	120	330/120/VP10	●	100
	10	VP10	150	330/150/VP10	●	100
	10	VP10	180	330/180/VP10	●	100
	10	VP10	220	330/220/VP10	●	100
	10	VP10	320	330/320/VP10	●	100
	10	VP10	400	330/400/VP10	●	100
	10	VP10	500	330/500/VP10	●	100
	10	VP10	600	330/600/VP10	●	100



For other dimensions, qualities or grits: contact Cibo.



● = available from stock

● = available in 5 working days

● = on request

> Paper sheets

A/O

PAPER



KP947F

application	backing	weight	grit type	coating	waterproof
	Paper	F	A/O	-	-

Grit range: 240-280-320-400

Description: Antistatic, closed coated aluminium oxide on a very strong "F" paper base. The antistatic property ensures the easy removal of dust. The KP947F is a product that can be used for various purposes. Perfect grade for both dry and hard woods as well as for those of a softer quality with a higher level of resin.

For other dimensions, qualities or grits: contact Cibo.

A/O

PAPER



KP905E

application	backing	weight	grit type	coating	waterproof
	Paper	E	A/O	-	-

Grit range: 40-60-80-100-120-150-180-220

Description: Antistatic, aluminium oxide on a strong "E" backing. Specially developed with a heavier, less tear-resistant backing for heavier, manual work and for applications on light manual grinding machines.

For other dimensions, qualities or grits: contact Cibo.

ZIRC.

PAPER



KP950F

application	backing	weight	grit type	coating	waterproof
	Paper	F	ZIRC.	-	-

Grit range: 40-60-80-100-120-150-180-220

Description: Zirconium oxide grain on an "F" paper base. This product is ideally suited for grinding very hard and dry woods because of the extremely abrasive-resistant zirconium oxide grit. The KP950F is also highly efficient when using stainless steel.

For other dimensions, qualities or grits: contact Cibo.

➤ Paper sheets

PAPER

S/C

SP706F

application	backing	weight	grit type	coating	waterproof
	Paper	F	S/C	-	-

Grit range: 24-36-40-50-60-80-100-120-150-180-220-240-280-320-400-500-600-800-1000-1200

Description: Antistatic silicon carbide grit on a very strong "F" base. Ideally suited for use in sanding wooden floors and parquet.

L x W	grit	code	stock	
475x200	24	706/24/475200	●	24
	36	706/36/475200	●	24
	40	706/40/475200	●	24
	60	706/60/475200	●	24
	80	706/80/475200	●	24
	100	706/100/475200	●	24
	120	706/120/475200	●	24
560x200	24	706/24/560200	●	24
	36	706/36/560200	●	24
	40	706/40/560200	●	24
	60	706/60/560200	●	24
	80	706/80/560200	●	24
	100	706/100/560200	●	24
	120	706/120/560200	●	24
685x200	24	706/24/685200	●	24
	36	706/36/685200	●	24
	40	706/40/685200	●	24
	60	706/60/685200	●	24
	80	706/80/685200	●	24
	100	706/100/685200	●	24
	120	706/120/685200	●	24



● = available from stock

● = available in 5 working days

● = on request

> Paper sheets

S/C

COMBINATION



LKE22

application	backing	weight	grit type	coating	waterproof
	Combina- tion	-	S/C	-	-



Grit range: 16-20

Description: Combination abrasive material. A heavy F paper reinforced with a light fabric and provided with a very open silicon carbide grit structure. Primarily for use in sanding old and dirty wooden floors and parquet. Also suitable for removing old paint, glue and varnish layers or carpet remains.

L x W	grit	code	stock	
475x200	16	LKE/16/475200	●	24
	20	LKE/20/475200	●	24
560x200	16	LKE/16/560200	●	24
	20	LKE/20/560200	●	24
685x200	16	LKE/16/685200	●	24
	20	LKE/20/685200	●	24



















➤ Paper waterproof sheets

KP915C - WATERPROOF

application	backing	weight	grit type	coating	waterproof
	Paper	C	A/O	-	

Grit range: 60-80-100-120-150-180-220-240-280-320-360-400-500-600-800-1000-1200

Description: High-quality and very flexible, waterproof sandpaper with aluminium oxide grit. The base consists of a flexible, easily pliable paper latex base with "C" weight. For use in the auto industry and, primarily with wet intermediate grinding of paints, lacquers and varnishes.

L x W	grit	code	stock	
280x230	60	915/60/280230		50
	80	915/80/280230		50
	100	915/100/280230		50
	120	915/120/280230		100
	150	915/150/280230		100
	180	915/180/280230		100
	220	915/220/280230		100
	240	915/240/280230		100
	280	915/280/280230		100
	320	915/320/280230		100
	360	915/360/280230		100
	400	915/400/280230		100
	500	915/500/280230		100
	600	915/600/280230		100
800	915/800/280230		100	
1000	915/1000/280230		100	
1200	915/1200/280230		100	

PAPER

A/O



 = available from stock

 = available in 5 working days

 = on request

> Paper waterproof sheets

S/C

PAPER

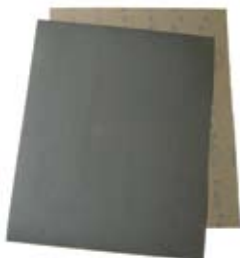

SP717C - WATERPROOF

application	backing	weight	grit type	coating	waterproof
	Paper	C	S/C	-	

Grit range: 60-80-100-120-150-180-220-240-280-320-360-400-500-600-800-1000-1200-1500-2000-2500

Description: High-quality and very flexible waterproof sandpaper with a silicon carbide grit type. The base consists of a flexible, easily pliable latex backing with "C" weight. Primarily for applications in the auto industry and auto repair shops.

L x W	grit	code	stock	
280x230	60	717/60/280230	●	50
	80	717/80/280230	●	50
	100	717/100/280230	●	50
	120	717/120/280230	●	100
	150	717/150/280230	●	100
	180	717/180/280230	●	100
	220	717/220/280230	●	100
	240	717/240/280230	●	100
	280	717/280/280230	●	100
	320	717/320/280230	●	100
	360	717/360/280230	●	100
	400	717/400/280230	●	100
	500	717/500/280230	●	100
	600	717/600/280230	●	100
	800	717/800/280230	●	100
	1000	717/1000/280230	●	100
	1200	717/1200/280230	●	100
1500	717/1500/280230	●	100	
2000	717/2000/280230	●	100	
2500	717/2500/280230	●	100	

➤ Cloth sheets

CLOTH ABRASIVES

A/O

TF41					
application	backing	weight	grit type	coating	waterproof
	Cotton	F	A/O	-	-
Grit range: 36-40-50-60-80-100-120-150-180-220-240-280-320					
Description: Very flexible abrasive cloth, for manual use in metal working. Also a perfect partner for grinding hard wood types.					
<i>For other dimensions, qualities or grits: contact Cibo.</i>					

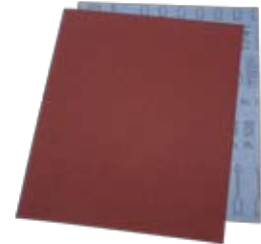

CLOTH ABRASIVES

A/O

TF50					
application	backing	weight	grit type	coating	waterproof
	Cotton	F	A/O	-	-
Grit range: 40-60-80-100-120-150-180-220-240-280-320-400-500-800					
Description: High-quality, very flexible abrasive cloth for general manual use in metal working. Also a perfect partner for grinding hard wood types.					
L x W	grit	code	stock		
280x230	40	TF50/40/280230	●	50	
	50	TF50/50/280230	●	50	
	60	TF50/60/280230	●	50	
	80	TF50/80/280230	●	50	
	100	TF50/100/280230	●	50	
	120	TF50/120/280230	●	50	
	150	TF50/150/280230	●	50	
	180	TF50/180/280230	●	50	
	220	TF50/220/280230	●	50	
	240	TF50/240/280230	●	50	
	280	TF50/280/280230	●	50	
	320	TF50/320/280230	●	50	
	400	TF50/400/280230	●	50	
	500	TF50/500/280230	●	50	



● = available from stock

● = available in 5 working days

● = on request

> Cloth sheets

CALIBRATED
A/O

CLOTH ABRASIVES



MFR

application	backing	weight	grit type	coating	waterproof
	Cotton	F	Calibrated A/O	-	*

Grit range: MFR1500 (P800)-MFR1800 (P1200)-MFR2400 (P1500)-MFR3200 (P3000)-MFR3600 (P3500)-MFR4000 (P4000)-MFR6000 (P5000)-MFR8000 (P6500)-MFR12000 (P8000)

Description: Micro-Mesh is a concept whereby extremely precisely calibrated grit crystals are bonded with a flexible glue on a supple cotton base. Due to the elastic positioning, this grit always comes in contact with the workpiece at a positive angle. This ensures a constant and even scratch depth. This ingeniously thought out design guarantees an extremely even, constant and precise finishing pattern.

For other dimensions, qualities or grits: contact Cibo.

CALIBRATED
A/O

CLOTH ABRASIVES



MFX

application	backing	weight	grit type	coating	waterproof
	Cotton	J	Calibrated A/O	-	*

Grit range: MFX180 (P600)-MFX240 (P1200)-MFX320 (P1500)-MFX400 (P3500)-MFX600 (P4000)-MFX800 (P5000)-MFX1200 (P6500)



Description: Micro-Mesh is a concept whereby extremely precisely calibrated grit crystals are bonded with a flexible glue on a supple cotton base. Due to the elastic positioning, this grit always comes in contact with the workpiece at a positive angle. This ensures a constant and even scratch depth. This ingeniously thought out design guarantees an extremely even, constant and precise finishing pattern.

For other dimensions, qualities or grits: contact Cibo.



(*) Micro-mesh achieves the best results provided a light mist is used.
The use of an excessive amount of water is not recommended with Micro-mesh.

> Mesh sheets









QNSH					
application	backing	weight	grit type	coating	waterproof
	Mesh	-	S/C	-	
Grit range: 40-60-80-100-120-150-180-220-320-400-500-600					
Description: Open polyester web structure to which grits are anchored on both sides.					
<i>For other dimensions, qualities or grits: contact Cibo.</i>					

CLOTH ABRASIVES

S/C



> Tex sheets

A/O					
application	backing	weight	grit type	coating	waterproof
	Nylon web	-	A/O	-	
Grit range: A-Coarse - A-Medium - A-Fine - A-Very Fine STRONG - A-Very Fine SOFT - A-Very Fine SUPERSOFT					
Description: The nylon fibres are combined into a three-dimensional web structure using thermo-setting synthetic resin, and are available in various grit types with an aluminium oxide grit. The result is an elastic abrasive material with an open structure that is easy to use and provides an even and constant finish. The tex material does not affect the geometrical shape of the work pieces. A/O creates a good long-lasting finish at high speeds.					
L x W	grit	code			stock 
224x158	AC	T/AC/224158			 50
	AM	T/AM/224158			 50
	AF	T/AF/224158			 50
	AVFStrong	T/AVFStrong/224158			 50
	AVFSoft	T/AVFSoft/224158			 50
	AVFSupersoft	T/AVFSupersoft/224158			 50

TEX

A/O



● = available from stock

● = available in 5 working days

● = on request

> **Tex sheets**

S/C TEX



S/C

application	backing	weight	grit type	coating	waterproof
	Nylon web	-	S/C	-	

Grit range: S-Medium - S-Fine - S-Very Fine - S-Ultra Fine 600 - S-Ultra Fine 1000 - S-Ultra Fine 1200

Description: The nylon fibres are combined into a three-dimensional web structure using thermo-setting synthetic resin, and are available in various grit sizes with silicon carbide grit. The result is an elastic abrasive material with an open structure that is easy to use and provides an even and constant finish. The tex material does not affect the geometrical shape of the work pieces. In comparison with the A/O, S/C provides a finer, more even and matt texture. Primarily used to create a decorative finish.

L x W	grit	code	stock	
224x158	SM	T/SM/224158	●	50
	SF	T/SF/224158	●	50
	SVF	T/SVF/224158	●	50
	600	T/SUF600/224158	●	50
	1000	T/SUF1000/224158	●	50
	1200	T/SUF1200/224158	●	50

CP TEX



CP

application	backing	weight	grit type	coating	waterproof
	Nylon web	-	CP	-	

Grit range: CP

Description: The nylon fibres are combined into a three-dimensional web structure using thermo-setting synthetic resin with an aluminium oxide grit type. The result is an elastic abrasive material with an open structure that is easy to use and provides an even and constant finish. The tex material does not affect the geometrical shape of the work pieces. CP has an increased grinding capacity at higher speeds. This material provides the brush structure with a slightly glossy effect.

L x W	grit	code	stock	
224x158	CP	T/CP/224158	●	50

Tex sheets

GP					
application	backing	weight	grit type	coating	waterproof
	Nylon web	–	GP	–	
Grit range: GP					
Description: The nylon fibres are combined into a three-dimensional web structure using thermo-setting synthetic resin with an alumino silicate grit type. The result is an elastic abrasive material with an open structure that is easy to use and provides an even and constant finish. The tex material does not affect the geometrical shape of the work pieces. GP is an economical product that is generally used for cleaning.					
L x W	grit	code			stock
224x158	GP	T/GP/224158			50

TEX

GP



00					
application	backing	weight	grit type	coating	waterproof
	Nylon web	–	00	–	
Grit range: no grit					
Description: With the TEX 00, the nylon fibres are combined into a three-dimensional web structure using thermo-setting synthetic resin without abrasive grit. This material does not scratch and is ideally suited for cleaning.					
L x W	grit	code			stock
224x158	0	T/00/224158			50

TEX

00



● = available from stock

● = available in 5 working days

● = on request

ROLLS

● Overview table	226
● Paper	236
○ Aluminium oxide	236
○ Zirconium oxide	240
○ Silicium carbide	241
● Cloth	243
○ Aluminium oxide	243
○ Micro-Mesh	245
● Mesh	246
○ Silicon carbide	246
● Tex	246
○ Aluminium oxide	246
○ Silicon carbide	247
○ CP	248
○ GP	248
○ 00	249



Cibo will very quickly produce for you any size, grade or grit that is not listed in the overview.

After all, customisation is the norm at Cibo.

ROLLS

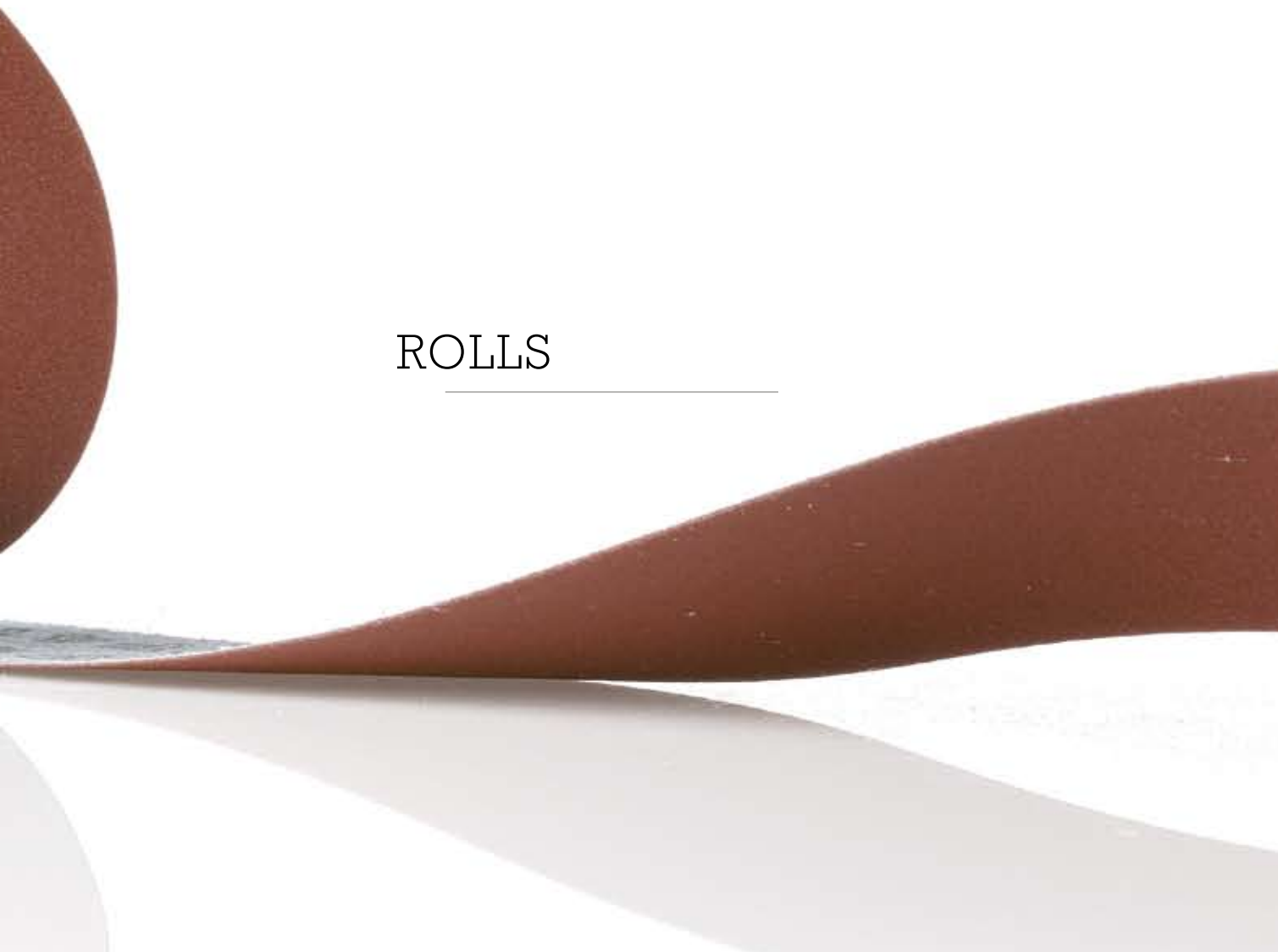

OVERVIEW

The Cibo warehouse has a complete section stocked with jumbo rolls of basic materials. The quantities are huge. A permanent stock of approximately 1,500 rolls in some 400 different grades or grit size ranges guarantees that you will find what you are looking for. Are you looking for rolls in an unusual width? Please contact Cibo -- we will make them for you in any width you need.

Application		Type	Backing	Weight	Type of grit	Top Coating	Waterproof	Maximum width	Grit type
Metal 	Cloth	TF41	Cotton	F	A/O	-	-	1420	36-40-50-60-80-100-120-150-180-220-240-280-320
		TF50	Cotton	F	A/O	-	-	1420	40-60-80-100-120-150-180-220-240-280-320-400-500-800
	Tex	A/O	Nylon web	-	A/O	-	☑	1500	A-Coarse - A-Medium - A-Fine - A-Very Fine STRONG - A-Very Fine SOFT - A-Very Fine SUPERSOFT
		CP	Nylon web	-	A/O CP	-	☑	610	CP
Stainless steel 	Paper	KP950F	Paper	F	ZIRC.	-	-	1450	40-60-80-100-120-150-180-220
	Cloth	TF41	Cotton	F	A/O	-	-	1420	36-40-50-60-80-100-120-150-180-220-240-280-320
		TF50	Cotton	F	A/O	-	-	1420	40-60-80-100-120-150-180-220-240-280-320-400-500-800
		MFR	Cotton	F	cali-brated A/O	-	☑*	500	MFR1500 (P800)-MFR1800 (P1200)-MFR2400 (P1500)-MFR3200 (P3000)-MFR3600 (P3500)-MFR4000 (P4000)-MFR6000 (P5000)-MFR8000 (P6500)-MFR12000 (P8000)
		MFX	Cotton	J	cali-brated A/O	-	☑*	500	MFX180 (P600)-MFX240 (P1200)-MFX320 (P1500)-MFX400 (P3500)-MFX600 (P4000)-MFX800 (P5000)-MFX1200 (P6500)

(*) Micro-mesh achieves the best results provided a light mist is used. The use of an excessive amount of water is not recommended with Micro-mesh.



USE OF THE TABLE

Simply look at the material you want to work on, select one or more of the abrasive materials recommended by Cibo, and you will be referred to the page on which you can find the roll you require. The referral page contains the most prevalent grit types and sizes.

However, customisation is also the norm at Cibo. If you need a roll a size not listed in the table, please do not hesitate to contact Cibo. We will manufacture it for you in almost no time.



Take note: this label only displays the sizes that are most suited for that specific application according to Cibo. Should you require a broader overview, please return to the comprehensive overview of the available basic materials on page 58.

Properties	Page
Very flexible abrasive cloth, for universal manual use in metal working.	243
High-quality, very flexible abrasive cloth for general manual use in metal working. Also a perfect partner for grinding hard wood types.	244
The nylon fibres are combined into a three-dimensional web structure using thermo-setting synthetic resin, and are available in various grit types with an aluminium oxide grit. The result is an elastic abrasive material with an open structure that is easy to use and provides an even and constant finish. The tex material does not affect the geometrical shape of the work pieces. A/O creates a good long-lasting finish at high speeds.	246
The nylon fibres are combined into a three-dimensional web structure using thermo-setting synthetic resin with an aluminium oxide grit type. The result is an elastic abrasive material with an open structure that is easy to use and provides an even and constant finish. The tex material does not affect the geometrical shape of the work pieces. CP has an increased grinding capacity at higher speeds. This material provides the brush structure with a slightly glossy effect.	248
Zirconium oxide grain on an "F" paper base. This product is ideally suited for grinding hard and dry wood types due to the extremely abrasion-resistant zirconium oxide grit. The KP950F is also highly efficient when using stainless steel.	240
Very flexible abrasive cloth, for universal manual use in metal working.	243
High-quality, very flexible abrasive cloth for general manual use in metal working. Also a perfect partner for grinding hard wood types.	244
Micro-Mesh is a concept whereby extremely precisely calibrated grit crystals are bonded with a flexible glue on a supple cotton base. Due to the elastic positioning, this grit always comes in contact with the workpiece at a positive angle. This ensures a constant and even scratch depth. This ingeniously thought out design guarantees an extremely even, constant and precise finishing pattern.	245
The nylon fibres are combined into a three-dimensional web structure using thermo-setting synthetic resin, and are available in various grit types with an aluminium oxide grit. The result is an elastic abrasive material with an open structure that is easy to use and provides an even and constant finish. The tex material does not affect the geometrical shape of the work pieces. A/O creates a good long-lasting finish at high speeds.	245



Application		Type	Backing	Weight	Type of grit	Top Coating	Waterproof	Maximum width	Grit type
Stainless steel 	Tex	A/O	Nylon web	–	A/O	–	☑	1500	A-Coarse - A-Medium - A-Fine - A-Very Fine STRONG - A-Very Fine SOFT - A-Very Fine SUPERSOFT
		S/C	Nylon web	–	S/C	–	☑	1500	S-Medium - S-Fine - S-Very Fine - S-Ultra Fine 600 - S-Ultra Fine 1000 - S-Ultra Fine 1200
		CP	Nylon web	–	A/O CP	–	☑	610	CP
High-quality alloys 	Cloth	TF41	Cotton	F	A/O	–	–	1420	36-40-50-60-80-100-120-150-180-220-240-280-320
		TF50	Cotton	F	A/O	–	–	1420	40-60-80-100-120-150-180-220-240-280-320-400-500-800
		MFR	Cotton	F	cali-brated A/O	–	☑*	500	MFR1500 (P800)-MFR1800 (P1200)-MFR2400 (P1500)-MFR3200 (P3000)-MFR3600 (P3500)-MFR4000 (P4000)-MFR6000 (P5000)-MFR8000 (P6500)-MFR12000 (P8000)
		MFX	Cotton	J	cali-brated A/O	–	☑*	500	MFX180 (P600)-MFX240 (P1200)-MFX320 (P1500)-MFX400 (P3500)-MFX600 (P4000)-MFX800 (P5000)-MFX1200 (P6500)
	Tex	S/C	Nylon web	–	S/C	–	☑	1500	S-Medium - S-Fine - S-Very Fine - S-Ultra Fine 600 - S-Ultra Fine 1000 - S-Ultra Fine 1200
Non-ferrous 	Cloth	TF41	Cotton	F	A/O	–	–	1420	36-40-50-60-80-100-120-150-180-220-240-280-320
		TF50	Cotton	F	A/O	–	–	1420	40-60-80-100-120-150-180-220-240-280-320-400-500-800
	Tex	S/C	Nylon web	–	S/C	–	☑	1500	S-Medium - S-Fine - S-Very Fine - S-Ultra Fine 600 - S-Ultra Fine 1000 - S-Ultra Fine 1200

(*) Micro-mesh achieves the best results provided a light mist is used. The use of an excessive amount of water is not recommended with Micro-mesh.

Properties	Page
The nylon fibres are combined into a three-dimensional web structure using thermo-setting synthetic resin, and are available in various grit types with an aluminium oxide grit. The result is an elastic abrasive material with an open structure that is easy to use and provides an even and constant finish. The tex material does not affect the geometrical shape of the work pieces. A/O creates a good long-lasting finish at high speeds.	246
The nylon fibres are combined into a three-dimensional web structure using thermo-setting synthetic resin, and are available in various grit sizes with silicon carbide grit. The result is an elastic abrasive material with an open structure that is easy to use and provides an even and constant finish. The tex material does not affect the geometrical shape of the work pieces. In comparison with the A/O, S/C provides a finer, more even and matt texture. Primarily used to create a decorative finish.	247
The nylon fibres are combined into a three-dimensional web structure using thermo-setting synthetic resin with an aluminium oxide grit type. The result is an elastic abrasive material with an open structure that is easy to use and provides an even and constant finish. The tex material does not affect the geometrical shape of the work pieces. CP has an increased grinding capacity at higher speeds. This material provides the brush structure with a slightly glossy effect.	248
Very flexible abrasive cloth, for universal manual use in metal working.	243
High-quality, very flexible abrasive cloth for general manual use in metal working. Also a perfect partner for grinding hard wood types.	244
Micro-Mesh is a concept whereby extremely precisely calibrated grit crystals are bonded with a flexible glue on a supple cotton base. Due to the elastic positioning, this grit always comes in contact with the workpiece at a positive angle. This ensures a constant and even scratch depth. This ingeniously thought out design guarantees an extremely even, constant and precise finishing pattern.	245
The nylon fibres are combined into a three-dimensional web structure using thermo-setting synthetic resin, and are available in various grit types with an aluminium oxide grit. The result is an elastic abrasive material with an open structure that is easy to use and provides an even and constant finish. The tex material does not affect the geometrical shape of the work pieces. A/O creates a good long-lasting finish at high speeds.	245
The nylon fibres are combined into a three-dimensional web structure using thermo-setting synthetic resin, and are available in various grit sizes with silicon carbide grit. The result is an elastic abrasive material with an open structure that is easy to use and provides an even and constant finish. The tex material does not affect the geometrical shape of the work pieces. In comparison with the A/O, S/C provides a finer, more even and matt texture. Primarily used to create a decorative finish.	247
Very flexible abrasive cloth, for universal manual use in metal working.	243
High-quality, very flexible abrasive cloth for general manual use in metal working. Also a perfect partner for grinding hard wood types.	244
The nylon fibres are combined into a three-dimensional web structure using thermo-setting synthetic resin, and are available in various grit sizes with silicon carbide grit. The result is an elastic abrasive material with an open structure that is easy to use and provides an even and constant finish. The tex material does not affect the geometrical shape of the work pieces. In comparison with the A/O, S/C provides a finer, more even and matt texture. Primarily used to create a decorative finish.	247



Application		Type	Backing	Weight	Type of grit	Top Coating	Waterproof	Maximum width	Grit type
Aluminium 	Cloth	TF41	Cotton	F	A/O	–	–	1420	36-40-50-60-80-100-120-150-180-220-240-280-320
		TF50	Cotton	F	A/O	–	–	1420	40-60-80-100-120-150-180-220-240-280-320-400-500-800
	Tex	S/C	Nylon web	–	S/C	–	💧	1500	S-Medium - S-Fine - S-Very Fine - S-Ultra Fine 600 - S-Ultra Fine 1000 - S-Ultra Fine 1200
Hard wood 	Paper	KP905E	Paper	E	A/O	–	–	1450	40-60-80-100-120-150-180-220
		KP947F	Paper	F	A/O	–	–	1450	240-280-320-400
		KP949FO	Paper	F	A/O	–	–	1450	36-40-50-60-80-100-120-150-180-220
		KP950F	Paper	F	ZIRC.	–	–	1450	40-60-80-100-120-150-180-220
		SP706F	Paper	F	S/C	–	–	1450	24-36-40-50-60-80-100-120-150-180-220-240-280-320-400-500-600-800-1000-1200
	Cloth	TF41	Cotton	F	A/O	–	–	1420	36-40-50-60-80-100-120-150-180-220-240-280-320
		TF50	Cotton	F	A/O	–	–	1420	40-60-80-100-120-150-180-220-240-280-320-400-500-800
	Tex	A/O	Nylon web	–	A/O	–	💧	1500	A-Coarse - A-Medium - A-Fine - A-Very Fine STRONG - A-Very Fine SOFT - A-Very Fine SUPERSOFT
Soft wood 	Paper	SA331	Film	–	A/O	●	💧	1350	80-120-320-400
		CA330	Paper	C	A/O	●	–	1350	60-80-100-120-150-180-220-320-400-500-600
		KP905E	Paper	E	A/O	–	–	1450	40-60-80-100-120-150-180-220

Properties	Page
Very flexible abrasive cloth, for universal manual use in metal working.	243
High-quality, very flexible abrasive cloth for general manual use in metal working. Also a perfect partner for grinding hard wood types.	244
The nylon fibres are combined into a three-dimensional web structure using thermo-setting synthetic resin, and are available in various grit sizes with silicon carbide grit. The result is an elastic abrasive material with an open structure that is easy to use and provides an even and constant finish. The tex material does not affect the geometrical shape of the work pieces. In comparison with A/O, S/C provides a finer, even and matt line structure. Primarily used to create a decorative finish.	247
Antistatic, aluminium oxide on a strong "E" backing. Specially developed with a heavier, less tear-resistant backing for heavier, manual work and for applications on light manual grinding machines.	238
Antistatic, closed coated aluminium oxide on a very strong "F" paper base. The antistatic property ensures the easy removal of dust . The KP947F is a product that can be used for various purposes. Perfect grade for both dry and hard woods as well as for those of a softer quality with a higher level of resin.	238
Antistatic, semi-open coated aluminium oxide on a very strong "F" paper base. The antistatic property ensures the easy removal of dust . The KP949FO is a product that can be used for various purposes. Perfect grade for both dry and hard woods as well as for those of a softer quality with a higher level of resin.	239
Zirconium oxide grain on an "F" paper base. This product is ideally suited for grinding hard and dry wood types due to the extremely abrasion-resistant zirconium oxide grit. The KP950F is also highly efficient when using stainless steel.	240
Antistatic silicon carbide grit on a very strong "F" base. Ideally suited for use in sanding wooden floors and parquet.	242
Very flexible abrasive cloth, for manual use in metal working. Also a perfect partner for grinding hard wood types.	243
High-quality, very flexible abrasive cloth for general manual use in metal working. Also a perfect partner for grinding hard wood types.	244
The nylon fibres are combined into a three-dimensional web structure using thermo-setting synthetic resin, and are available in various grit types with an aluminium oxide grit. The result is an elastic abrasive material with an open structure that is easy to use and provides an even and constant finish. The tex material does not affect the geometrical shape of the work pieces. A/O creates a good long-lasting finish at high speeds.	246
Open coated aluminium oxide grit with an active abrasive ingredient on a film backing. Extremely tear-resistant. Does not clog up, long life span, extremely large grit size range. Can be used for many purposes, especially with more intensive grinding operations. Ideal for finishing of soft wood types and car repair, paints, lacquers and varnishes. Used both wet and dry.	236
Open coated aluminium oxide with grinding aid on flexible "C" paper. Very pliable and flexible, cannot saturate, adapts easily to the workpiece and guarantees a beautiful, even finish. Ideal for grinding primary coats, primers, sealers, lacquers, paint, varnish, filler and wood.	237
Antistatic, aluminium oxide on a strong "E" backing. Specially developed with a heavier, less tear-resistant backing for heavier, manual work and for applications on light manual grinding machines.	238

Application		Type	Backing	Weight	Type of grit	Top Coating	Waterproof	Maximum width	Grit type
Soft wood 	Paper	KP947F	Paper	F	A/O	-	-	1450	240-280-320-400
		KP949FO	Paper	F	A/O	-	-	1450	36-40-50-60-80-100-120-150-180-220
		SP706F	Paper	F	S/C	-	-	1450	24-36-40-50-60-80-100-120-150-180-220-240-280-320-400-500-600-800-1000-1200
	Cloth	QNSH	Mesh	-	S/C	-	💧	910	40-60-80-100-120-150-180-220-320-400-500-600
	Tex	A/O	Nylon web	-	A/O	-	💧	1500	A-Coarse - A-Medium - A-Fine - A-Very Fine STRONG - A-Very Fine SOFT - A-Very Fine SUPERSOFT
Glass & stone 	Paper	SP706F	Paper	F	S/C	-	-	1450	24-36-40-50-60-80-100-120-150-180-220-240-280-320-400-500-600-800-1000-1200
	Tex	00	Nylon web	-	Talc	-	💧	1500	-
Plastics & Rubber 	Cloth	MFR	Cotton	F	cali-brated A/O	-	💧*	500	MFR1500 (P800)-MFR1800 (P1200)-MFR2400 (P1500)-MFR3200 (P3000)-MFR3600 (P3500)-MFR4000 (P4000)-MFR6000 (P5000)-MFR8000 (P6500)-MFR12000 (P8000)
		MFX	Cotton	J	cali-brated A/O	-	💧*	500	MFX180 (P600)-MFX240 (P1200)-MFX320 (P1500)-MFX400 (P3500)-MFX600 (P4000)-MFX800 (P5000)-MFX1200 (P6500)
	Tex	S/C	Nylon web	-	S/C	-	💧	1500	S-Medium - S-Fine - S-Very Fine - S-Ultra Fine 600 - S-Ultra Fine 1000 - S-Ultra Fine 1200

(*) Micro-mesh achieves the best results provided a light mist is used. The use of an excessive amount of water is not recommended with Micro-mesh.

Properties	Page
Antistatic, closed coated aluminium oxide on a very strong "F" paper base. The antistatic property ensures the easy removal of dust . The KP947FO is a product that can be used for a wide variety of applications. Perfect grade for both dry and hard woods as well as for those of a softer quality with a higher level of resin.	238
Antistatic, semi-open coated aluminium oxide on a very strong "F" paper base. The antistatic property ensures the easy removal of dust . The KP949FO is a product that can be used for various purposes. Perfect grade for both dry and hard woods as well as for those of a softer quality with a higher level of resin.	239
Antistatic silicon carbide grit on a very strong "F" base. Ideally suited for use in sanding wooden floors and parquet.	242
Open polyester web structure to which grits are anchored on both sides.	246
The nylon fibres are combined into a three-dimensional web structure using thermo-setting synthetic resin, and are available in various grit types with an aluminium oxide grit. The result is an elastic abrasive material with an open structure that is easy to use and provides an even and constant finish. The tex material does not affect the geometrical shape of the work pieces. A/O creates a good long-lasting finish at high speeds.	246
Antistatic silicon carbide grit on a very strong "F" base. Ideally suited for use in sanding wooden floors and parquet.	242
With the TEX 00, the nylon fibres are combined into a three-dimensional web structure using thermo-setting synthetic resin without abrasive grit. This material does not scratch and is ideally suited for cleaning.	249
Micro-Mesh is a concept whereby extremely precisely calibrated grit crystals are bonded with a flexible glue on a supple cotton base. Due to the elastic positioning, this grit always comes in contact with the workpiece at a positive angle. This ensures a constant and even scratch depth. This ingeniously thought out design guarantees an extremely even, constant and precise finishing pattern.	245
The nylon fibres are combined into a three-dimensional web structure using thermo-setting synthetic resin, and are available in various grit types with an aluminium oxide grit. The result is an elastic abrasive material with an open structure that is easy to use and provides an even and constant finish. The tex material does not affect the geometrical shape of the work pieces. A/O creates a good long-lasting finish at high speeds.	245
The nylon fibres are combined into a three-dimensional web structure using thermo-setting synthetic resin, and are available in various grit sizes with silicon carbide grit. The result is an elastic abrasive material with an open structure that is easy to use and provides an even and constant finish. The tex material does not affect the geometrical shape of the work pieces. In comparison with A/O, S/C provides a finer, even and matt line structure. Primarily used to create a decorative finish.	247

Application		Type	Backing	Weight	Type of grit	Top Coating	Waterproof	Maximum width	Grit type
Car repair 	Paper	SA331	Film	–	A/O	●	💧	1350	Grip: 40-60-80-100-120-150-180-220-320-400-600-800-1200 Without grip: 80-120-320-400
		CA330	Paper	C	A/O	●	–	1350	Grip: 60-80-100-120-150-180-220-240-320-400-500-600 Without grip: 60-80-100-120-150-180-220-320-400-500-600
	Cloth	QNSH	Mesh	–	S/C	–	💧	910	40-60-80-100-120-150-180-220-320-400-500-600
	Tex	A/O	Nylon web	–	A/O	–	💧	1500	A-Coarse - A-Medium - A-Fine - A-Very Fine STRONG - A-Very Fine SOFT - A-Very Fine SUPERSOFT
		S/C	Nylon web	–	S/C	–	💧	1500	S-Medium - S-Fine - S-Very Fine - S-Ultra Fine 600 - S-Ultra Fine 1000 - S-Ultra Fine 1200
		00	Nylon web	–	OO	–	💧	1500	No grit
Lacquer & varnish 	Paper	SA331	Film	–	A/O	●	💧	1350	80-120-220-320-400
		CA330	Paper	C	A/O	●	–	1350	60-80-100-120-150-180-220-320-400-500-600
		SP705EO	Paper	E	S/C	●	–	1450	220-240-280-320-400-500-600-800
	Tex	A/O	Nylon web	–	A/O	–	💧	1500	A-Coarse - A-Medium - A-Fine - A-Very Fine STRONG - A-Very Fine SOFT - A-Very Fine SUPERSOFT
		S/O	Nylon web	–	S/C	–	💧	1500	S-Medium - S-Fine - S-Very Fine - S-Ultra Fine 600 - S-Ultra Fine 1000 - S-Ultra Fine 1200
		00	Nylon web	–	OO	–	💧	1500	No grit

Properties	Page
Open coated aluminium oxide grit with an active abrasive ingredient on a film backing. Extremely tear-resistant. Does not clog up, long life span, extremely large grit size range. Can be used for many purposes, especially with more intensive grinding operations. Ideal for finishing of soft wood types and car repair, paints, lacquers and varnishes. Used both wet and dry.	236
Open coated aluminium oxide with grinding aid on flexible "C" paper. Very pliable and flexible, cannot saturate, adapts easily to the workpiece and guarantees a beautiful, even finish. Ideal for grinding primary coats, primers, sealers, lacquers, paint, varnish, filler and wood.	237
Open polyester web structure to which grits are anchored on both sides.	246
The nylon fibres are combined into a three-dimensional web structure using thermo-setting synthetic resin, and are available in various grit types with an aluminium oxide grit. The result is an elastic abrasive material with an open structure that is easy to use and provides an even and constant finish. The tex material does not affect the geometrical shape of the work pieces. A/O creates a good long-lasting finish at high speeds.	246
The nylon fibres are combined into a three-dimensional web structure using thermo-setting synthetic resin, and are available in various grit sizes with silicon carbide grit. The result is an elastic abrasive material with an open structure that is easy to use and provides an even and constant finish. The tex material does not affect the geometrical shape of the work pieces. In comparison with A/O, S/C provides a finer, even and matt line structure. Primarily used to create a decorative finish.	247
With the TEX 00, the nylon fibres are combined into a three-dimensional web structure using thermo-setting synthetic resin without abrasive grit. This material does not scratch and is ideally suited for cleaning.	249
Open coated aluminium oxide grit with an active abrasive ingredient on a film backing. Extremely tear-resistant. Does not clog up, long life span, extremely large grit size range. Can be used for many purposes, especially with more intensive grinding operations. Ideal for finishing of soft wood types and car repair, paints, lacquers and varnishes. The SA331 can also be used for finishing metal, stainless steel, non-ferrous metal, aluminium and hard woods. Used both wet and dry.	236
Open coated aluminium oxide with grinding aid on flexible "C" paper. Very pliable and flexible, cannot saturate, adapts easily to the workpiece and guarantees a beautiful, even finish. Ideal for grinding primary coats, primers, sealers, lacquers, paint, varnish, filler and wood.	237
Antistatic silicon carbide grit on a "E" paper with the addition of zinc stearate. This paper is ideally suited for finishing. The addition of stearate ensures that the grinding process is cool and that the grit does not become saturated. Ideal for the intermediate grinding of primers, sealers, paints, varnishes, polyester and polyurethane lacquers, etc.	241
The nylon fibres are combined into a three-dimensional web structure using thermo-setting synthetic resin, and are available in various grit types with an aluminium oxide grit. The result is an elastic abrasive material with an open structure that is easy to use and provides an even and constant finish. The tex material does not affect the geometrical shape of the work pieces. A/O creates a good long-lasting finish at high speeds.	246
The nylon fibres are combined into a three-dimensional web structure using thermo-setting synthetic resin, and are available in various grit sizes with silicon carbide grit. The result is an elastic abrasive material with an open structure that is easy to use and provides an even and constant finish. The tex material does not affect the geometrical shape of the work pieces. In comparison with A/O, S/C provides a finer, even and matt line structure. Primarily used to create a decorative finish.	247
With the TEX 00, the nylon fibres are combined into a three-dimensional web structure using thermo-setting synthetic resin without abrasive grit. This material does not scratch and is ideally suited for cleaning.	249

> Paper rolls

A/O

FILM

SA331

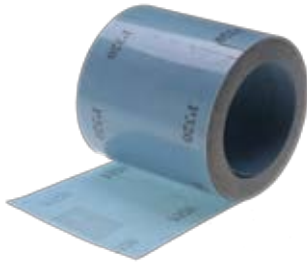

application	backing	weight	grit type	coating	waterproof
	Film	-	A/O	●	💧

Grit type: 80-120-320-400

Description: Open coated aluminium oxide grit with an active abrasive ingredient on a film backing. Extremely tear-resistant. Does not overflow, long life span, extremely large grit size range. Can be used for many purposes, especially with more intensive grinding operations. Ideal for finishes of soft wood types and car repair, paints, lacquers and varnishes. Used both wet and dry.

L x W	grit	code	stock	
50000x100	80	331/80/50100	●	1
	120	331/120/50100	●	1
	220	331/220/50100	●	1
	320	331/320/50100	●	1
	400	331/400/50100	●	1
50000x115	80	331/80/50115	●	1
	120	331/120/50115	●	1
	220	331/220/50115	●	1
	320	331/320/50115	●	1
	400	331/400/50115	●	1

Paper rolls: importance of the backing

In choosing the correct paper type, flexibility and the tear-resistance are two important parameters. These are determined by the weight of the paper. The letters "A" through "F" refer to the weight. "A" refers to the lightest type of paper, "F" the heaviest.

Generally speaking, paper types A, B and C are a lot more flexible and can be used for finer grit types. The grades on a flexible backing ensure a finer and more homogenous finish in comparison to heavier backings. The latter are preferred for coarser grit types and therefore for more aggressive applications.

> Paper rolls

CA330

PAPER

A/O

application	backing	weight	grit type	coating	waterproof
	Paper	C	A/O	●	-

Grit type: 60-80-100-120-150-180-220-320-400-500-600

Description: Open coated aluminium oxide with grinding aid on flexible "C" paper. Very pliable and flexible, cannot saturate, adapts easily to the workpiece and guarantees a beautiful, even finish. Ideal for grinding primary coats, primers, sealers, lacquers, paint, varnish, filler and wood.

L x W	grit	code	stock	
50000x100	60	330/60/50100	●	1
	80	330/80/50100	●	1
	100	330/100/50100	●	1
	120	330/120/50100	●	1
	150	330/150/50100	●	1
	180	330/180/50100	●	1
	220	330/220/50100	●	1
	320	330/320/50100	●	1
	400	330/400/50100	●	1
	500	330/500/50100	●	1
	600	330/600/50100	●	1
50000x115	60	330/60/50115	●	1
	80	330/80/50115	●	1
	100	330/100/50115	●	1
	120	330/120/50115	●	1
	150	330/150/50115	●	1
	180	330/180/50115	●	1
	220	330/220/50115	●	1
	320	330/320/50115	●	1
	400	330/400/50115	●	1
	500	330/500/50115	●	1
	600	330/600/50115	●	1



● = available from stock

● = available in 5 working days

● = on request

> Paper rolls

A/O

PAPER

KP905E



application	backing	weight	grit type	coating	waterproof
	Paper	E	A/O	-	-

Grit type: 40-60-80-100-120-150-180-220

Description: Antistatic, aluminium oxide on a strong "E" backing. Specially developed with a heavier, less tear-resistant backing for heavier, manual work and for applications on light manual grinding machines.

L x W	grit	code	stock	
50000x150	40	905/40/50150	●	1
	60	905/60/50150	●	1
	80	905/80/50150	●	1
	100	905/100/50150	●	1
	120	905/120/50150	●	1
	150	905/150/50150	●	1
	180	905/180/50150	●	1
	220	905/220/50150	●	1

A/O

PAPER

KP947F



application	backing	weight	grit type	coating	waterproof
	Paper	F	A/O	-	-

Grit type: 240-280-320-400

Description: Antistatic, closed coated aluminium oxide on a very strong "F" paper base. The antistatic property ensures the easy removal of dust. The KP947F is a product that can be used for various purposes. Perfect grade for both dry and hard woods as well as for those of a softer quality with a higher level of resin.

Please consult Cibo on sizes, qualities and grit.

> Paper rolls

KP949FO

PAPER

A/O

application	backing	weight	grit type	coating	waterproof
	Paper	F	A/O	-	-

Grit type: 36-40-50-60-80-100-120-150-180-220

Description: Antistatic, semi-open coated aluminium oxide on a very strong "F" paper base. The antistatic property ensures the easy removal of dust. The KP949FO is a product that can be used for various purposes. Perfect grade for both dry and hard woods as well as for those of a softer quality with a higher level of resin.

L x W	grit	code	stock	
50000x100	36	949/36/50100	●	1
	40	949/40/50100	●	1
	50	949/50/50100	●	1
	60	949/60/50100	●	1
	80	949/80/50100	●	1
	100	949/100/50100	●	1
	120	949/120/50100	●	1
	150	949/150/50100	●	1
	180	949/180/50100	●	1
	220	949/220/50100	●	1
50000x115	36	949/36/50115	●	1
	40	949/40/50115	●	1
	50	949/50/50115	●	1
	60	949/60/50115	●	1
	80	949/80/50115	●	1
	100	949/100/50115	●	1
	120	949/120/50115	●	1
	150	949/150/50115	●	1
	180	949/180/50115	●	1
	220	949/220/50115	●	1



● = available from stock

● = available in 5 working days

● = on request



KP949FO

L x W	grit	code	stock	
50000x150	36	949/36/50150	●	1
	40	949/40/50150	●	1
	50	949/50/50150	●	1
	60	949/60/50150	●	1
	80	949/80/50150	●	1
	100	949/100/50150	●	1
	120	949/120/50150	●	1
	150	949/150/50150	●	1
	180	949/180/50150	●	1
220	949/220/50150	●	1	

> Paper rolls

ZIRC.

PAPER

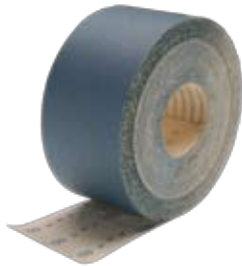

KP950F

application	backing	weight	grit type	coating	waterproof
	Paper	F	ZIRC.	-	-







Grit type: 40-60-80-100-120-150-180-220

Description: Zirconium oxide grain on an "F" paper base. This product is ideally suited for grinding hard and dry wood types due to the extremely abrasion-resistant zirconium oxide grit. The KP950F is also highly efficient when using stainless steel.

Please consult Cibo on sizes, qualities and grit.

> Paper rolls

SP705EO

application	backing	weight	grit type	coating	waterproof
     	Paper	E	S/C	●	-

Grit type: 220-240-280-320-400-500-600-800

Description: Antistatic silicon carbide grit on a "E" paper with the addition of zinc stearate. This paper is ideally suited for finishing. The addition of stearate ensures that the grinding process is cool and that the grit does not become saturated. Ideal for the intermediate grinding of primers, sealers, paints, varnishes, polyester and polyurethane lacquers, etc.

Please consult Cibo on sizes, qualities and grit.

PAPER

S/C

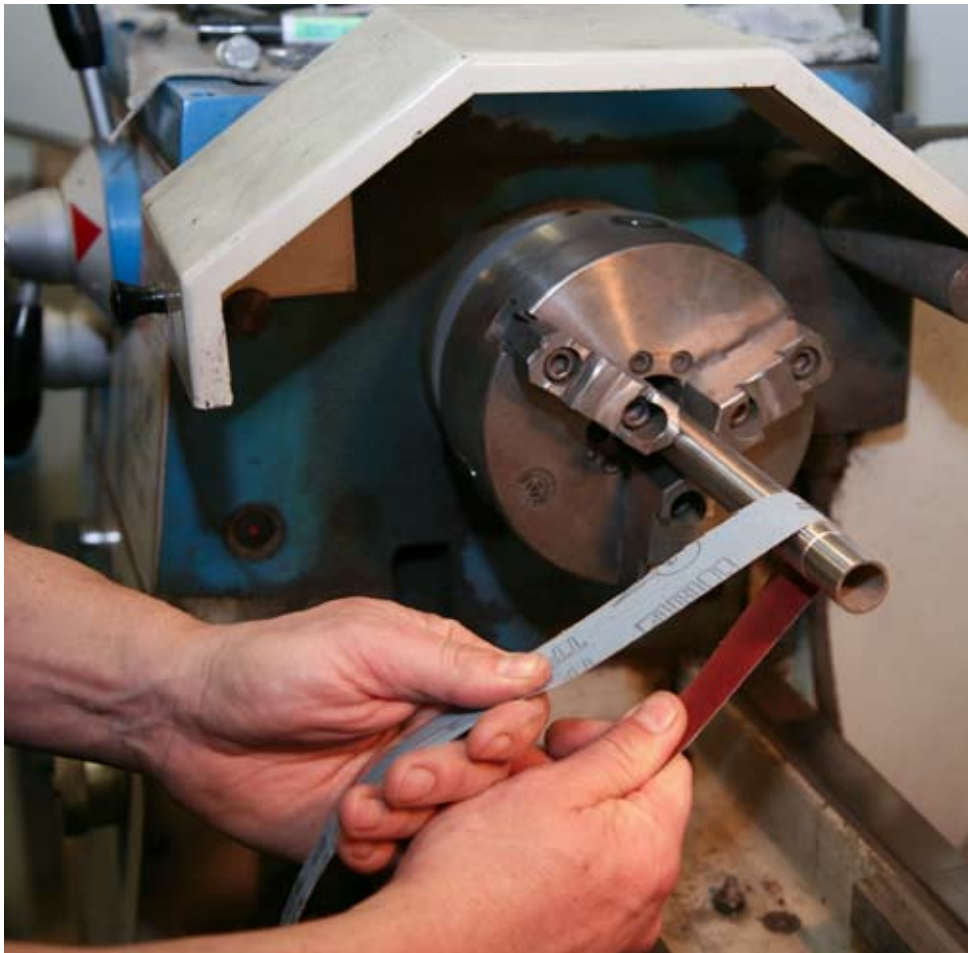

● = available from stock

● = available in 5 working days

● = on request

> Paper rolls

S/C

PAPER

SP706F



application	backing	weight	grit type	coating	waterproof
	Paper	F	S/C	-	-
Grit type: 24-36-40-50-60-80-100-120-150-180-220-240-280-320-400-500-600-800-1000-1200					
Description: Antistatic silicon carbide grit on a very strong "F" base. Ideally suited for use in sanding wooden floors and parquet.					
L x W	grit	code	stock		
50000x200	24	706/24/50200	●	1	
	36	706/36/50200	●	1	
	40	706/40/50200	●	1	
	50	706/50/50200	●	1	
	60	706/60/50200	●	1	
	80	706/80/50200	●	1	
	100	706/100/50200	●	1	
	120	706/120/50200	●	1	
	150	706/150/50200	●	1	
	180	706/180/50200	●	1	
50000x250	24	706/24/50250	●	1	
	36	706/36/50250	●	1	
	40	706/40/50250	●	1	
	50	706/50/50250	●	1	
	60	706/60/50250	●	1	
	80	706/80/50250	●	1	
	100	706/100/50250	●	1	
	120	706/120/50250	●	1	
	150	706/150/50250	●	1	
	180	706/180/50250	●	1	
220	706/220/50250	●	1		

> Cloth rolls

CLOTH ABRASIVES

A/O

TF41					
application	backing	weight	grit type	coating	waterproof
	Cotton	F	A/O	-	-
Grit type: 36-40-50-60-80-100-120-150-180-220-240-280-320					
Description: Very flexible abrasive cloth, for manual use in metal working. Also a perfect partner for grinding hard wood types.					
L x W	grit	code			stock
50000x50	36	TF41/36/5050			● 1
	40	TF41/40/5050			● 1
	50	TF41/50/5050			● 1
	60	TF41/60/5050			● 1
	80	TF41/80/5050			● 1
	100	TF41/100/5050			● 1
	120	TF41/120/5050			● 1
	150	TF41/150/5050			● 1
	180	TF41/180/5050			● 1
	220	TF41/220/5050			● 1
	240	TF41/240/5050			● 1
	280	TF41/280/5050			● 1
	320	TF41/320/5050			● 1



● = available from stock

● = available in 5 working days

● = on request

> **Cloth rolls**

A/O

CLOTH ABRASIVES

TF50



application	backing	weight	grit type	coating	waterproof
	Cotton	F	A/O	-	-



Grit type: 40-60-80-100-120-150-180-220-240-280-320-400-500-800

Description: High-quality, very flexible abrasive cloth for general manual use in metal working. Also a perfect partner for grinding hard wood types.

L x W	grit	code	stock	
50000x100	40	TF50/40/50100	●	1
	50	TF50/50/50100	●	1
	60	TF50/60/50100	●	1
	80	TF50/80/50100	●	1
	100	TF50/100/50100	●	1
	120	TF50/120/50100	●	1
	150	TF50/150/50100	●	1
	180	TF50/180/50100	●	1
	220	TF50/220/50100	●	1
	240	TF50/240/50100	●	1
	280	TF50/280/50100	●	1
	320	TF50/320/50100	●	1
	400	TF50/400/50100	●	1
	500	TF50/500/50100	●	1
	800	TF50/800/50100	●	1



Please consult Cibo on sizes, qualities and grit.

> Cloth rolls

MFR						
application	backing	weight	grit type	coating	waterproof	
	Cotton	F	Calibrated A/O	-		
Grit type:	MFR1500 (P800)-MFR1800 (P1200)-MFR2400 (P1500)-MFR3200 (P3000)-MFR3600 (P3500)-MFR4000 (P4000)-MFR6000 (P5000)-MFR8000 (P6500)-MFR12000 (P8000)					
Description:	Micro-Mesh is a concept whereby extremely precisely calibrated grit crystals are bonded with a flexible glue on a supple cotton base. Due to the elastic positioning, this grit always comes in contact with the workpiece at a positive angle. This ensures a constant and even scratch depth. This ingeniously thought out design guarantees an extremely even, constant and precise finishing pattern.					
<i>Please consult Cibo on sizes, qualities and grit.</i>						

CLOTH ABRASIVES

CALIBRATED
A/O

MFX						
application	backing	weight	grit type	coating	waterproof	
	Cotton	J	Calibrated A/O	-		
Grit type:	MFX180 (P600)-MFX240 (P1200)-MFX320 (P1500)-MFX400 (P3500)-MFX600 (P4000)-MFX800 (P5000)-MFX1200 (P6500)					
Description:	Micro-Mesh is a concept whereby extremely precisely calibrated grit crystals are bonded with a flexible glue on a supple cotton base. Due to the elastic positioning, this grit always comes in contact with the workpiece at a positive angle. This ensures a constant and even scratch depth. This ingeniously thought out design guarantees an extremely even, constant and precise finishing pattern.					
<i>Please consult Cibo on sizes, qualities and grit.</i>						

CLOTH ABRASIVES

CALIBRATED
A/O

(*) Micro-mesh achieves the best results provided a light mist is used.
The use of an excessive amount of water is not recommended with Micro-mesh.

● = available from stock

● = available in 5 working days

● = on request

> Mesh rolls

S/C

CLOTH ABRASIVES

QNSH



application	backing	weight	grit type	coating	waterproof
	Sanding mesh	-	S/C	-	
Grit type: 40-60-80-100-120-150-180-220-320-400-600					
Description: Open polyester web structure to which grits are anchored on both sides.					
<i>Please consult Cibo on sizes, qualities and grit.</i>					

> Tex rolls

A/O

TEX

A/O



application	backing	weight	grit type	coating	waterproof
	Nylon web	-	A/O	-	
Grit type: A-Coarse - A-Medium - A-Fine - A-Very Fine STRONG - A-Very Fine SOFT - A-Very Fine SUPERSOFT					
Description: The nylon fibres are combined into a three-dimensional web structure using thermo-setting synthetic resin, and are available in various grit types with an aluminium oxide grit. The result is an elastic abrasive material with an open structure that is easy to use and provides an even and constant finish. The tex material does not affect the geometrical shape of the work pieces. A/O creates a good long-lasting finish at high speeds.					
L x W	grit	code	stock		
10000x100	AC	T/AC/10100		1	
	AM	T/AM/10100		1	
	AF	T/AF/10100		1	
	AVFStrong	T/AVFStrong/10100		1	
	AVFSoft	T/AVFSoft/10100		1	
	AVFSupersoft	T/AVFUSoft/10100		1	
10000x150	AC	T/AC/10150		1	
	AM	T/AM/10150		1	
	AF	T/AF/10150		1	
	AVFStrong	T/AVFStrong/10150		1	
	AVFSoft	T/AVFSoft/10150		1	
	AVFSupersoft	T/AVFUSoft/10150		1	

> Tex rolls

S/C						TEX	S/C
application	backing	weight	grit type	coating	waterproof		
	Nylon web	-	S/C	-			
Grit type: S-Medium - S-Fine - S-Very Fine - S-Ultra Fine 600 - S-Ultra Fine 1000 - S-Ultra Fine 1200							
Description: The nylon fibres are combined into a three-dimensional web structure using thermo-setting synthetic resin, and are available in various grit sizes with silicon carbide grit. The result is an elastic abrasive material with an open structure that is easy to use and provides an even and constant finish. The tex material does not affect the geometrical shape of the work pieces. In comparison with the A/O, S/C provides a finer, more even and matt texture. Primarily used to create a decorative finish.							
L x W	grit	code			stock		
10000x100	SM	T/SM/10100				1	
	SF	T/SF/10100				1	
	SVF	T/SVF/10100				1	
	SUF600	T/SUF600/10100				1	
	SUF1000	T/SUF1000/10100				1	
	SUF1200	T/SUF1200/10100				1	
10000x150	SM	T/SM/10150				1	
	SF	T/SF/10150				1	
	SVF	T/SVF/10150				1	
	SUF600	T/SUF600/10150				1	
	SUF1000	T/SUF1000/10150				1	
	SUF1200	T/SUF1200/10150				1	



= available from stock

= available in 5 working days

= on request

> **Tex rolls**

CP TEX



CP

application	backing	weight	grit type	coating	waterproof
	Nylon web	-	CP	-	

Grit type: CP

Description: The nylon fibres are combined into a three-dimensional web structure using thermo-setting synthetic resin with an aluminium oxide grit type. The result is an elastic abrasive material with an open structure that is easy to use and provides an even and constant finish. The tex material does not affect the geometrical shape of the work pieces. CP has an increased grinding capacity at higher speeds. This material provides the brush structure with a slightly glossy effect.

L x W	grit	code	stock	
10000x100	CP	T/CP/10100		1
10000x150	CP	T/CP/10150		1

GP TEX



GP

application	backing	weight	grit type	coating	waterproof
	Nylon web	-	GP	-	

Grit type: VERY FINE

Description: The nylon fibres are combined into a three-dimensional web structure using thermo-setting synthetic resin with an alumino silicate grit type. The result is an elastic abrasive material with an open structure that is easy to use and provides an even and constant finish. The tex material does not affect the geometrical shape of the work pieces. GP is an economical product that is generally used for cleaning.

L x W	grit	code	stock	
10000x100	GP	T/GP/10100		1
10000x150	GP	T/GP/10150		1

FLAP DISCS

Flap discs for stock removal 253

- **Cloth flaps** 258
 - Glass fibre backing 258
 - Standard line 258
 - Flat
 - Conical
 - Industrial line 259
 - Flat
 - Conical
 - Extended
 - High Performance 260
 - Flat
 - Conical
 - Top line 261
 - Extended
 - Flat
 - Conical
 - TAF 262
 - Flat
 - Conical
 - Plastic backing 264
 - TAF 264
 - Flat
 - Conical
 - Quick Change 266
 - Socatt®
 - Lockit®

Finishing discs 269

- **RCD** 270
 - Combi flaps 272
- **LVT** 274
 - Surface conditioning flaps 276
- **SAG** 278
 - Unitized 280



Cibo can also rapidly manufacture any sizes, grades or grit types that are not listed in the overview. After all, customisation is the norm at Cibo.

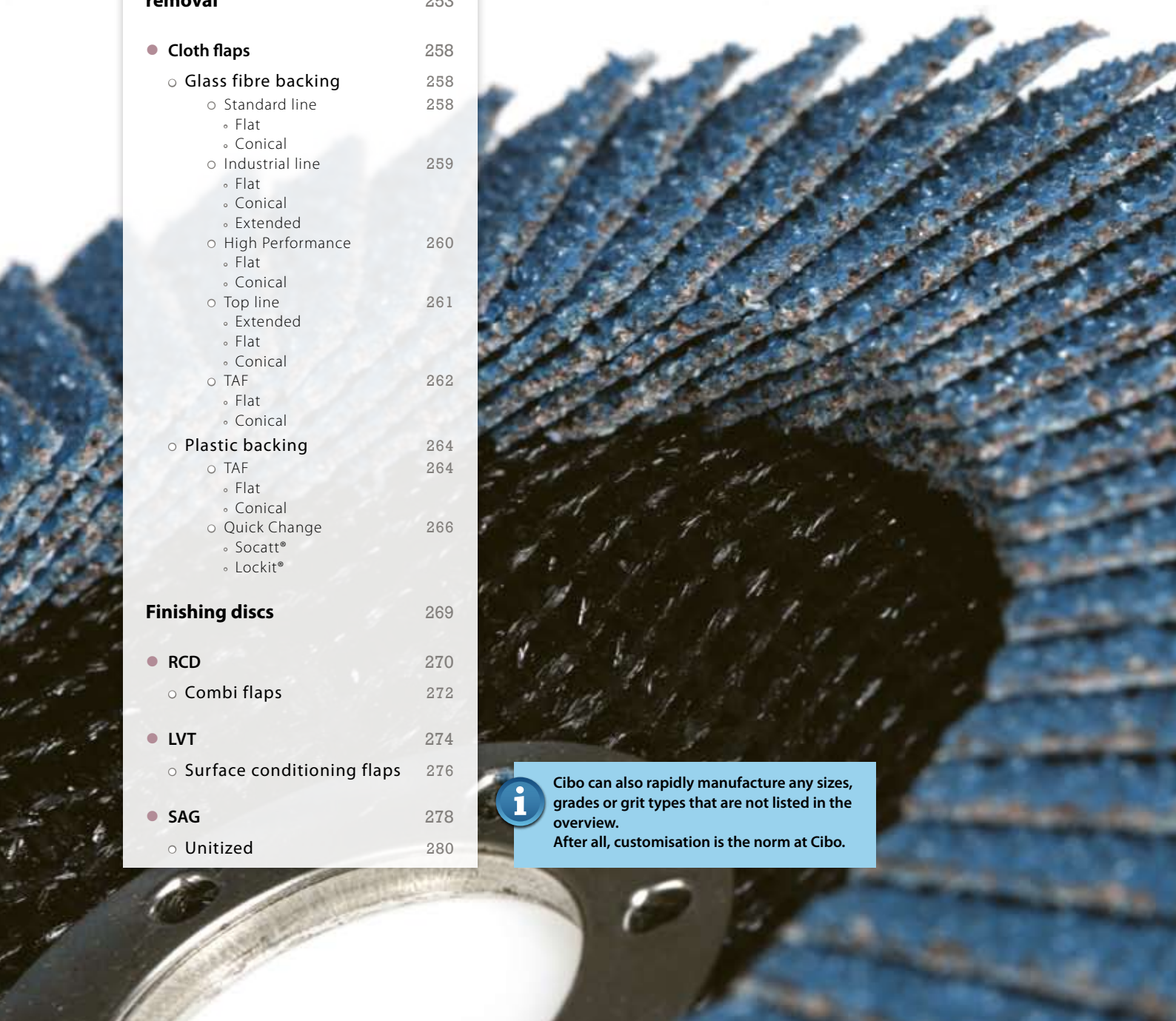

FLAP DISCS

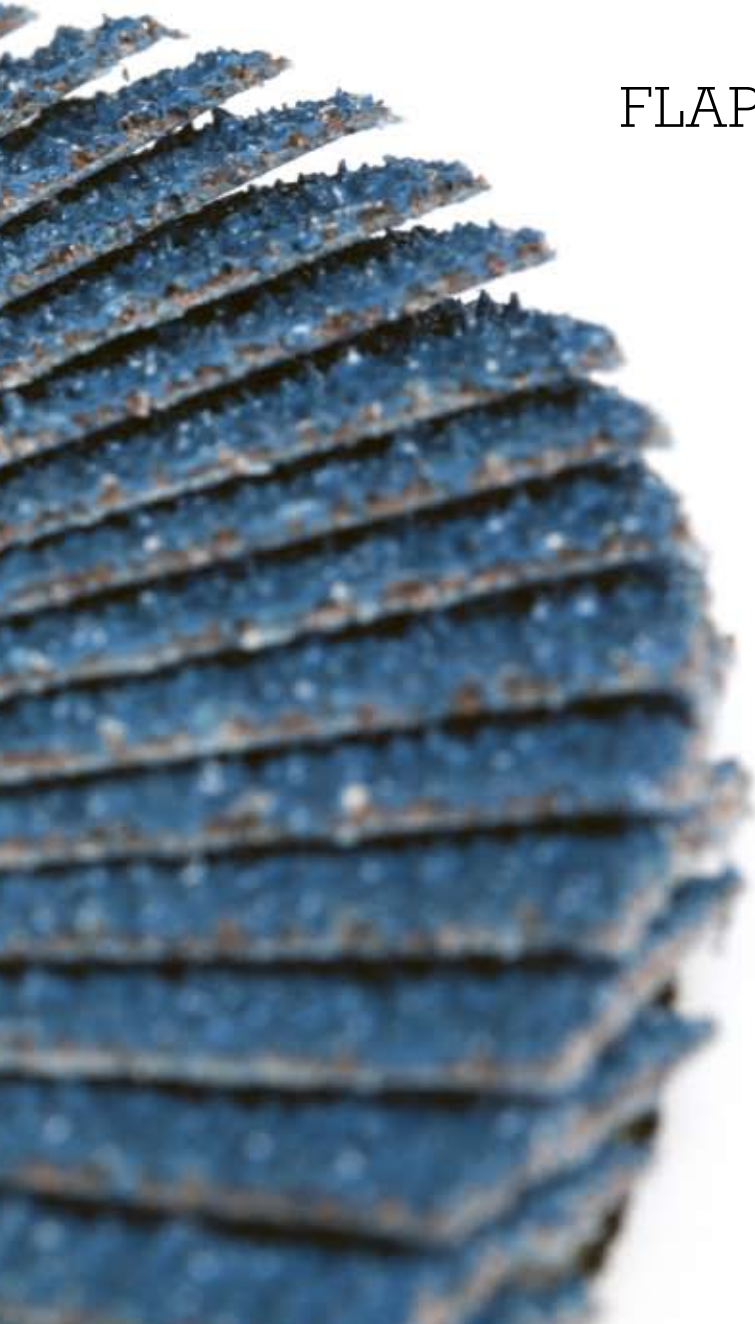





▶ Flap discs for stock removal

The average flap disc has the capacity to grind reasonably quickly and provide a reasonable finish. In comparison to the grinding disc, it produces hardly any noise and is free of vibration. It has been developed and continuously improved over many years. In the past, one disc was used to work all types of material and workpieces. Nowadays, however, there are very specific flap discs with very distinct properties. As a result, we now have special discs available to work specific material in very specific circumstances. Given the correct choice, each operator has efficient and technically advanced discs at his disposal to achieve a very controlled finish.

With a good flap disc it is important that the abrasive grit wears at the same rate as the cloth.

Given the very large variety on the market, it is not easy to make the right choice. If requested, the Cibo experts can provide an accurate analysis of your requirements and will advise you on how to save time and money.

The following pages contain an overview of the parameters that will determine your choice. They provide you with guidelines for selecting flap discs for stock removal.

➤ WHAT TYPE OF FLAP DISC TO SELECT?



STOCK REMOVAL CAPACITY

This is often one of the first parameters under consideration in choosing a flap disc. If this parameter is important to you, you should take into account the total stock removal capacity of a disc within a specific time frame and under similar circumstances.

After all, certain discs have a very high initial cutting power, but they lose this cutting capacity after 3 to 5 minutes. Other discs only offer very high stock removal capacity at a high working pressure with the machine at high capacity. This is tiring for the operator; the machines required weigh considerably more, and not everyone has high-powered machines available.

USEFUL LIFESPAN

Very often, the total lifespan of a disc is used as a reference when making a selection. At first glance, this may appear a good line of thought. However, when we look at the total grinding cost, we often find that this parameter is deceptive. In most industrial countries, labour costs are a very important factor in determining the total finishing costs of a workpiece. Therefore, your total cost price is not only determined by the lifespan, but also by the quantity of stock removal.

PRICE OF THE DISC

Very often, it is easy to allow oneself to be blinded by the purchase price of the disc. There are very cheap discs available on the market today which at first glance appear excellent. In this context, many operators have personally experienced how deceptive this can prove to be. Please read on and you will find out that the most expensive disc to purchase is usually the cheapest to use.



TOTAL GRINDING COSTS

A cost price that takes into account all elements that determine cost is probably the only correct one.

The speed and amount of stock removal per unit of time during the entire life span of the disc are the most decisive factors in the cost price of grinding.



Total grinding costs for stock removal of 1 kg stainless steel weld seam

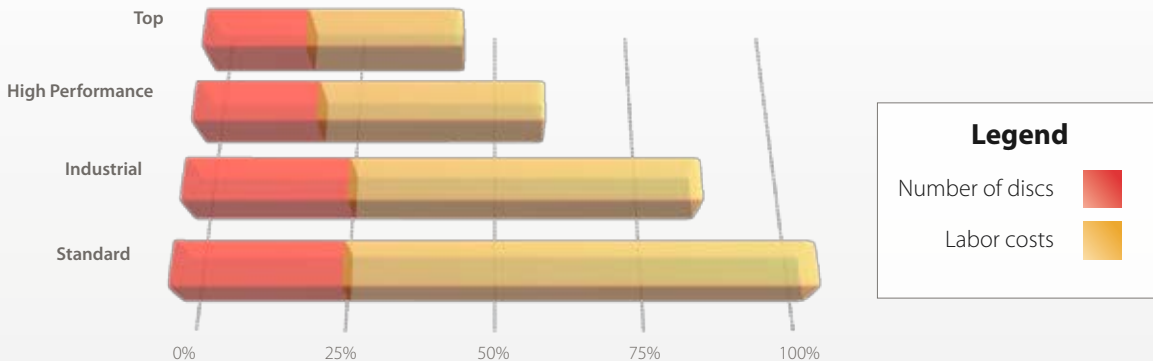

➤ WHAT TYPE OF FLAP DISC TO SELECT?

GLASS FIBRE OR PLASTIC BACKING?

Plastic backings do not have any immediate advantage over glass fibre backings. The glass fibre backings used by Cibo are entirely free from iron and consequently are ideal for use with stainless steel. Furthermore, they wear down together with the abrasive cloth without causing any damage to the workpiece. They therefore allow you to completely use the available abrasive cloth.



Did you know that Cibo has set up its own flap disc department? In mid-2010, production capacity amounted to 2,500,000 discs. For these flap discs, Cibo uses abrasive cloth with specific properties. The standard, Industrial and the High Performance lines with their zirconium oxide grit, as well as the Top line with our latest ceramic quality, ensure the very fast removal of material and allow you to save considerably on labour.





Glass fibre backings

Low High

	Stock removal capacity	Useful life	Finishing	Flexibility
Standard - Cibo				
Industrial - Cibo				
High Performance - Cibo				
Top - Cibo				
Crossing C - Cibo				
Crossing Z - Cibo				
LVZ - TAF				



Plastic backings

Low High

	Stock removal capacity	Useful life	Finishing	Flexibility
43/A				
61/Z				
43/C				
91/Z				
47/58Z				

➤ Cloth flaps / Glass fibre backing



STANDARD LINE

FSF - FLAT



dimensions	grit	code	type	max RPM	stock	
Ø 115x22	40	FSF/40/115	Zirc.	13200	●	10
	60	FSF/60/115	Zirc.	13200	●	10
	80	FSF/80/115	Zirc.	13200	●	10
	120	FSF/120/115	Zirc.	13200	●	10
Ø 125x22	40	FSF/40/125	Zirc.	11000	●	10
	60	FSF/60/125	Zirc.	11000	●	10
	80	FSF/80/125	Zirc.	11000	●	10
	120	FSF/120/125	Zirc.	11000	●	10



STANDARD LINE

FSC - CONICAL



dimensions	grit	code	type	max RPM	stock	
Ø 115x22	40	FSC/40/115	Zirc.	13200	●	10
	60	FSC/60/115	Zirc.	13200	●	10
	80	FSC/80/115	Zirc.	13200	●	10
	120	FSC/120/115	Zirc.	13200	●	10
Ø 125x22	40	FSC/40/125	Zirc.	11000	●	10
	60	FSC/60/125	Zirc.	11000	●	10
	80	FSC/80/125	Zirc.	11000	●	10
	120	FSC/120/125	Zirc.	11000	●	10



> Cloth flaps / Glass fibre backing

FNF - FLAT

dimensions	grit	code	type	max RPM	stock	
Ø 115x22	40	FNF/40/115	Zirc.+	13200	●	10
	60	FNF/60/115	Zirc.+	13200	●	10
	80	FNF/80/115	Zirc.+	13200	●	10
	120	FNF/120/115	Zirc.+	13200	●	10
Ø 125x22	40	FNF/40/125	Zirc.+	11000	●	10
	60	FNF/60/125	Zirc.+	11000	●	10
	80	FNF/80/125	Zirc.+	11000	●	10
	120	FNF/120/125	Zirc.+	11000	●	10

INDUSTRIAL LINE



FNC - CONICAL

dimensions	grit	code	type	max RPM	stock	
Ø 115x22	40	FNC/40/115	Zirc.+	13200	●	10
	60	FNC/60/115	Zirc.+	13200	●	10
	80	FNC/80/115	Zirc.+	13200	●	10
	120	FNC/120/115	Zirc.+	13200	●	10
Ø 125x22	40	FNC/40/125	Zirc.+	11000	●	10
	60	FNC/60/125	Zirc.+	11000	●	10
	80	FNC/80/125	Zirc.+	11000	●	10
	120	FNC/120/125	Zirc.+	11000	●	10

INDUSTRIAL LINE



FOZ - EXTENDED

dimensions	grit	code	type	max RPM	stock	
Ø 115x22	40	FOZ/40/115	Zirc.+	13200	●	10
	60	FOZ/60/115	Zirc.+	13200	●	10
	80	FOZ/80/115	Zirc.+	13200	●	10
Ø 125x22	40	FOZ/40/125	Zirc.+	11000	●	10
	60	FOZ/60/125	Zirc.+	11000	●	10
	80	FOZ/80/125	Zirc.+	11000	●	10

INDUSTRIAL LINE



● = available from stock

● = available in 5 working days

● = on request

➤ Cloth flaps / Glass fibre backing



HIGH PERFORMANCE
LINE



FPF - FLAT

dimensions	grit	code	type	max RPM	stock	
Ø 115x22	40	FPF/40/115	Zirc.+++	13200	●	10
	60	FPF/60/115	Zirc.+++	13200	●	10
	80	FPF/80/115	Zirc.+++	13200	●	10
Ø 125x22	40	FPF/40/125	Zirc.+++	11000	●	10
	60	FPF/60/125	Zirc.+++	11000	●	10
	80	FPF/80/125	Zirc.+++	11000	●	10



HIGH PERFORMANCE
LINE



FPC - CONICAL

dimensions	grit	code	type	max RPM	stock	
Ø 115x22	40	FPC/40/115	Zirc.+++	13200	●	10
	60	FPC/60/115	Zirc.+++	13200	●	10
	80	FPC/80/115	Zirc.+++	13200	●	10
Ø 125x22	40	FPC/40/125	Zirc.+++	11000	●	10
	60	FPC/60/125	Zirc.+++	11000	●	10
	80	FPC/80/125	Zirc.+++	11000	●	10



➤ Cloth flaps / Glass fibre backing



Other configurations are possible; please consult Cibo.

● = available from stock

● = available in 5 working days

● = on request

➤ Cloth flaps / Glass fibre backing



TAF



LVZ34 - FLAT

dimensions	grit	code	type	max RPM	stock	
Ø 115x22	40	LVZ34/40	Zirc.+	13200	●	20
	60	LVZ34/60	Zirc.+	13200	●	20
	80	LVZ34/80	Zirc.+	13200	●	20
	120	LVZ34/120	Zirc.+	13200	●	20



TAF



LVZ42 - FLAT

dimensions	grit	code	type	max RPM	stock	
Ø 125x22	40	LVZ42/40	Zirc.+	11000	●	20
	60	LVZ42/60	Zirc.+	11000	●	20
	80	LVZ42/80	Zirc.+	11000	●	20
	120	LVZ42/120	Zirc.+	11000	●	20



TAF



LVZ66 - FLAT

dimensions	grit	code	type	max RPM	stock	
Ø 180x22	36	LVZ66/36	Zirc.+	6000	●	10
	40	LVZ66/40	Zirc.+	6000	●	10
	60	LVZ66/60	Zirc.+	6000	●	10
	80	LVZ66/80	Zirc.+	6000	●	10
	120	LVZ66/120	Zirc.+	6000	●	10

➤ Cloth flaps / Glass fibre backing

LVZ38 - CONICAL

dimensions	grit	code	type	max RPM	stock	
Ø 115x22	40	LVZ38/40	Zirc.+	13200	●	20
	60	LVZ38/60	Zirc.+	13200	●	20
	80	LVZ38/80	Zirc.+	13200	●	20
	120	LVZ38/120	Zirc.+	13200	●	20

TAF



LVZ44 - CONICAL

dimensions	grit	code	type	max RPM	stock	
Ø 125x22	40	LVZ44/40	Zirc.+	11000	●	20
	60	LVZ44/60	Zirc.+	11000	●	20
	80	LVZ44/80	Zirc.+	11000	●	20
	120	LVZ44/120	Zirc.+	11000	●	20

TAF



LVZ69 - CONICAL

dimensions	grit	code	type	max RPM	stock	
Ø 180x22	36	LVZ69/36	Zirc.+	6000	●	10
	40	LVZ69/40	Zirc.+	6000	●	10
	60	LVZ69/60	Zirc.+	6000	●	10
	80	LVZ69/80	Zirc.+	6000	●	10
	120	LVZ69/120	Zirc.+	6000	●	10

TAF



● = available from stock

● = available in 5 working days

● = on request

> Cloth flaps / Plastic backing



TAF - RESIN BONDED



47Z - FLAT

dimensions	grit	code	type	max RPM	stock	
Ø 115x22	40	47Z/40	Zirc.	13200	●	20
	60	47Z/60	Zirc.	13200	●	20
	80	47Z/80	Zirc.	13200	●	20
	120	47Z/120	Zirc.	13200	●	20



TAF - RESIN BONDED



58Z - FLAT

dimensions	grit	code	type	max RPM	stock	
Ø 125x22	40	58Z/40	Zirc.	13200	●	20
	60	58Z/60	Zirc.	13200	●	20
	80	58Z/80	Zirc.	13200	●	20
	120	58Z/120	Zirc.	13200	●	20



TAF - INTERNALLY BONDED



43A - FLAT

dimensions	grit	code	type	max RPM	stock	
Ø 110x22	40	43A/40	Al.-Ox.	11000	●	20
	60	43A/60	Al.-Ox.	11000	●	20
	80	43A/80	Al.-Ox.	11000	●	20
	100	43A/100	Al.-Ox.	11000	●	20
	120	43A/120	Al.-Ox.	11000	●	20
	150	43A/150	Al.-Ox.	11000	●	20
	180	43A/180	Al.-Ox.	11000	●	20
	220	43A/220	Al.-Ox.	11000	●	20



Other configurations are possible; please consult Cibo.

> Cloth flaps / Plastic backing

61Z - FLAT

dimensions	grit	code	type	max RPM	stock	
Ø 110x22	36	61Z/36	Zirc.	11000	●	20
	40	61Z/40	Zirc.	11000	●	20
	50	61Z/50	Zirc.	11000	●	20
	60	61Z/60	Zirc.	11000	●	20
	80	61Z/80	Zirc.	11000	●	20
	120	61Z/120	Zirc.	11000	●	20

TAF - INTERNALLY BONDED



43C - FLAT

dimensions	grit	code	type	max RPM	stock	
Ø 110x22	60	43C/60	Sil. Carb.	11000	●	20
	80	43C/80	Sil. Carb.	11000	●	20
	120	43C/120	Sil. Carb.	11000	●	20
	220	43C/220	Sil. Carb.	11000	●	20
	320	43C/320	Sil. Carb.	11000	●	20

TAF - INTERNALLY BONDED



91Z - CONICAL

dimensions	grit	code	type	max RPM	stock	
Ø 110x22	40	91Z/40	Zirc.	11000	●	20
	60	91Z/60	Zirc.	11000	●	20
	80	91Z/80	Zirc.	11000	●	20
	120	91Z/120	Zirc.	11000	●	20

TAF - INTERNALLY BONDED



We recommend using 43A, 61Z, 43C, 91Z with the universal flange set **MHD13**. For additional information, see p. 484.

● = available from stock

● = available in 5 working days

● = on request

➤ Cloth flaps / Plastic backing

SOCATT®

QUICK-CHANGE

MSZV - FLAT



diameter	grit	code	type	max RPM	code support	stock	
Ø 50	40	MSZV/40/50	Zirc.	15000	QSRH/M/50M14	●	10
	60	MSZV/60/50	Zirc.	15000		●	10
	80	MSZV/80/50	Zirc.	15000		●	10
	120	MSZV/120/50	Zirc.	15000		●	10
Ø 75	40	MSZV/40/75*	Zirc.	10000	QSRH/M/75M14/MF	●	10
	60	MSZV/60/75*	Zirc.	10000		●	10
	80	MSZV/80/75*	Zirc.	10000		●	10
	120	MSZV/120/75*	Zirc.	10000		●	10



(*) Caution! Use Ø75 only with support QSRH/M/75M14/MF. See p. 313

LOCKIT®

QUICK-CHANGE

MLZV - FLAT



diameter	grit	code	type	max RPM	code support	stock	
Ø 50	40	MLZV/40/50	Zirc.	15000	QLRH/M/50M14	●	10
	60	MLZV/60/50	Zirc.	15000		●	10
	80	MLZV/80/50	Zirc.	15000		●	10
	120	MLZV/120/50	Zirc.	15000		●	10
Ø 75	40	MLZV/40/75	Zirc.	10000	QLRH/M/75M14/MF	●	10
	60	MLZV/60/75	Zirc.	10000		●	10
	80	MLZV/80/75	Zirc.	10000		●	10
	120	MLZV/120/75	Zirc.	10000		●	10

Socatt® and Lockit® are brandnames of the 3M Company.



Additional information about the supports is available in the chapter on accessories.



● = available from stock

● = available in 5 working days

● = on request



Finishing discs

The *Cibo* finishing discs are flap discs which, besides a limited removal of material, allow you to achieve a very high-quality finish in almost no time,

The flap discs for stock removal are distinguished by their reasonably quick material removal, but they do not succeed in safely creating a beautiful and constant decorative finish. They often create irreparable grinding errors, especially on workpieces where a decorative or cosmetic finish is required.

Stainless steel, aluminium and non-ferrous metals are materials that are often used in sectors where very high standards are required for the finish. In order to meet high market demand, *Cibo* has developed a number of very efficient and exclusive finishing discs.

These discs attract attention because of their capacity to create a constant and reproducible finish in a safe and controlled manner, mainly on stainless steel, aluminium and non-ferrous metals.

The range of finishing discs consists of 3 families: the **RCD**, the **LVT** and the **SAG**.



Finishing discs

Low High

	Stock removal capacity	Useful life	Finishing	Flexibility
RCD				
LVT				
SAG				



THE RCD-DISC

This disc is often used with:

- Finishing light weld seams
- Finishing angles and tothing
- Improving the surface roughness
- Refining coarse grinding lines
- Breaking edges
- Grinding down casting errors
- Removing milling lines
- Homogenising surfaces
- Preparation for polishing
- Remove welding spatter
- Light deburring

For efficient use of the RCD:

Follow the recommended speed and you will see a drastic decrease in your grinding costs, together with a significantly better and, especially, more even finish.

Recommended speed : 3,600 – 6,000 RPM

The Cibo RCD-disc allows you to grind down weld seams and provide a flawless finish in a single operation.

This revolutionary and universally patented Cibo innovation consists of two complementary abrasive materials which provide fantastic results in a single operation. In the past, an experienced grinder required at least three operations to completely remove a weld seam. An inexperienced user can now complete this task in a single step.

"State of the art" abrasive cloth for the quick, controlled and cool removal of material.

Surface conditioning flaps ensure an even finish even at low pressure.

original patented - original patented
**WORLDWIDE
 PATENTED**
 original patented product - original patented

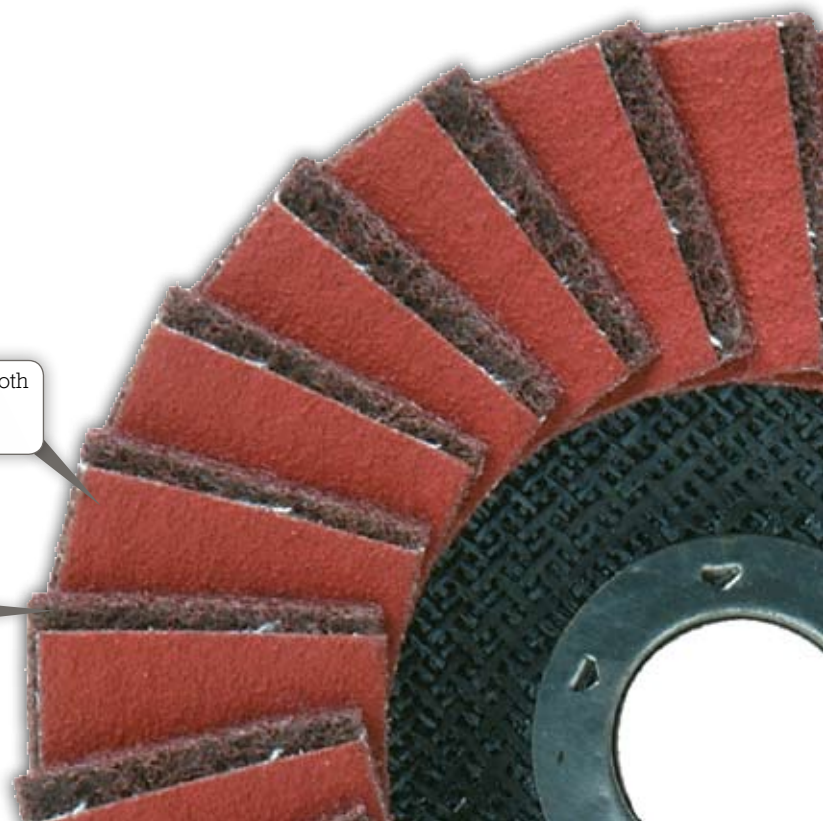

BENEFITS

- Controlled material removal
- Forgiving
- Even finish
- Constant and low Ra-value
- Improved finish, even for inexperienced users
- Lower heat generation
- Enormous time savings, only one operation instead of three
- Significant cost savings
- Can be used in a wide variety of applications: stainless steel, aluminium, special alloys, soft metals, wood, auto repair, etc.
- Eco-friendly because less waste is created

PROPERTIES

- A perfect match between 2 technically advanced abrasive materials with varying abrasive capacities
- Surface Conditioning with a very rapid and even grinding capacity
- Polycotton extra flexible abrasive cloth with grinding aid
- Even wear of both the Surface Conditioning and the abrasive cloth
- Shock reducing effect



Combi flaps / Glass fibre backing



TOP LINE



RCD



The optimal rpm for working with the RCD-disc is **3,600 to 6,000 RPM**. This way you can prevent areas being burnt, the disc has a longer lifespan and you can maintain absolute control of the grinding process.

RCD - CONICAL

- Properties:**
- Controlled material removal
 - Even finish
 - Constant and low Ra-value
 - Shock dampening effect
 - Lower heat generation
 - Very broad application areas : Stainless steel, aluminium, soft metals, special alloys,...
- Applications:**
- Finishing light weld seams
 - Finishing angles and toothing
 - Improving the surface roughness
 - Refining coarse grinding lines
 - Breaking edges
 - Grinding down casting errors
 - Etc.

dimensions	grit	code	type	max RPM	advised RPM	stock	
Ø 115x22	XC	RCD/XC/115	Al.-Ox.	13200	6.000	●	10
	CO	RCD/CO/115	Al.-Ox.	13200	6.000	●	10
	ME	RCD/ME/115	Al.-Ox.	13200	6.000	●	10
	VF	RCD/VF/115	Al.-Ox.	13200	6.000	●	10
Ø 125x22	XC	RCD/XC/125	Al.-Ox.	11000	5500	●	10
	CO	RCD/CO/125	Al.-Ox.	11000	5500	●	10
	ME	RCD/ME/125	Al.-Ox.	11000	5500	●	10
	VF	RCD/VF/125	Al.-Ox.	11000	5500	●	10
Ø 180x22	XC	RCD/XC/180	Al.-Ox.	6000	3.600	●	10
	ME	RCD/ME/180	Al.-Ox.	6000	3.600	●	10



XC = Extra Coarse - CO = Coarse - ME = Medium - VF = Very Fine





TIP: The three golden rules for RCD.

1



WORKING PRESSURE

A well controlled working pressure is important for the end result. Work with the RCD at light pressure.

2



WORKING ANGLE

Grind at an angle of 10° to 15° (between the disc and the work-piece) to enlarge the contact surface

3



GRINDING MOVEMENT

Make a back and forth movement with the RCD lengthwise along the work piece. The grinding movement with an RCD-disc is particularly important. The rotation of the disc is in the direction of the desired structure, the movement of the grinding tool is the opposite direction.



Tips & tricks: Grind down a weld seam on a round outside angle.



- Mount the RCD with the help of a flange on a variable speed angle grinder.
- Use the RCD Medium to grind down the weld seam.
- Use the RCD to grind down to the zone where both tubes come in contact with each other at the highest point. This is the point where the round outside corner moves into the hollow inside angle.
- After completing one side using the RCD, repeat the process on the other side.
- This process is completed when the outside angle where both tubes meet is nicely sharp and round, and the outside angle flows nicely into the inside angle.

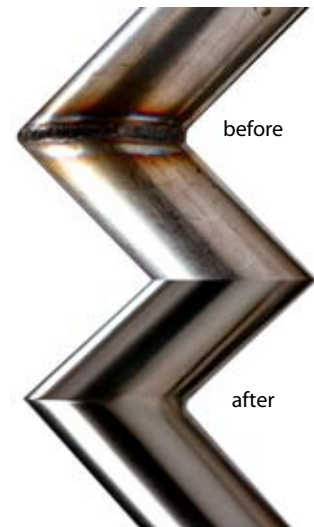

► THE LVT-DISC

The LVT-disc is also a Cibo innovation, developed in 2001.

The power of this flap disc is in the constant decorative finish it can apply, mainly on stainless steel, but also on non-ferrous metals and high grade alloys. The LVT disc is manufactured entirely with flaps from surface conditioning. It is simple in use and guarantees a perfect finish, even for inexperienced users. However, please note: this disc works correctly only when used at a low rpm (5,500-6,000 RPM). Additionally, you should take into account that this type of disc has only limited abrasive capacity and is not suitable for heavy work.





Did you know the material of the LVT-disc has an open web structure which makes it ideal to remove lacquer in, for example, the automobile sector?

➤ Surface Conditioning flap discs / Glass fibre backing



INDUSTRIAL LINE



LVT - CONICAL

dimensions	grit	code	type	max RPM	advised RPM	stock	
Ø 115x22	CO	LVT/EC1/115	Al.-Ox.	13200	6000	●	10
	ME	LVT/EC2/115	Al.-Ox.	13200	6000	●	10
	VF	LVT/EC3/115	Al.-Ox.	13200	6000	●	10
Ø 125x22	CO	LVT/EC1/125	Al.-Ox.	11000	5500	●	10
	ME	LVT/EC2/125	Al.-Ox.	11000	5500	●	10
	VF	LVT/EC3/125	Al.-Ox.	11000	5500	●	10



CO = Coarse - ME = Medium - VF = Very Fine



TOP LINE



LVT - CONICAL

Advantages:

With regard to the industrial line surface conditioning discs, this flap disc has the following additional properties :

- extra long lifespan, allowing for significant time saving due to the lower number of disc replacements
- even cooler operation
- even faster results
- constant finish

dimensions	grit	code	type	max RPM	advised RPM	stock	
Ø 115x22	CO	LVT/RC1/115	Al.-Ox.	13200	6000	●	10
	ME	LVT/RC2/115	Al.-Ox.	13200	6000	●	10
	VF	LVT/RC3/115	Al.-Ox.	13200	6000	●	10
Ø 125x22	CO	LVT/RC1/125	Al.-Ox.	11000	5500	●	10
	ME	LVT/RC2/125	Al.-Ox.	11000	5500	●	10
	VF	LVT/RC3/125	Al.-Ox.	11000	5500	●	10



Other compositions are possible: contact CIBO.



● = available from stock

● = available in 5 working days

● = on request



➤ THE SAG DISC

The SAG is the absolute “missing link” between grinding and high-gloss polishing of round pieces. This disc is composed of unitized material on a glass fibre backing, which makes it a perfect addition to the RCD-discs. The flexible material also adapts perfectly to the shape of the workpiece, allowing you to grind away any scratches or minor damage from your workpiece. The SAG is also the ideal last step prior to polishing. You can create a fantastically even finish for the surface in almost no time at all, and little or no follow-up work is necessary.

The SAG allows you to work in a very controlled manner and to create a beautiful, constant and reproducible finish, time and time again.

Unitized abrasive material combines a reasonable degree of aggression with an excellent finish. Thanks to the fibre's unique structure and the special synthetic resins the unitized material consists of, Cibo can guarantee you a 100% smear-free operation of its disc. The disc is entirely free from iron, allowing it to be used to work stainless steel, all non-ferrous metals, cobalt and titanium alloys.



Caution : it is very important that your workpiece is sufficiently cooled before you start working it with the unitized disc!

The SAG consists of 4 different densities, which always determine the hardness, the material removal, the level of finish and the control of the workpiece.



Did you know that the pharmaceutical and food sector have very high standards for the surface smoothness of their products, because no traces of food or medication are allowed to remain on the surface? Using the SAG, the Ra-value of the surface can be managed perfectly.



APPLICATIONS

- Remove discolouration
- Breaking of corners, deburring and rounding
- Correct grinding errors and remove scratches
- Remove lacquers and coatings
- Remove rust
- Pre-polishing
- Improving surface roughness
- ...



Speed

- Always consult the product label with regard to our recommended speed
- Excessive speed can lead to excessive heat generation and premature wear
- A low rpm guarantees maximum efficiency and a better finish

Pressure

- Excessive pressure causes additional heat generation, and this can lead to grinding errors and premature wear
- If the pressure is too low, the SAG will grind insufficiently or not at all

> Unitized material / Glass fibre backing



TOP LINE



SAG - FLAT

Properties : Long lifespan, resistance to angles, open web structure, free of iron, does not leave any residue, adapts itself to the workpiece, grinds cooler,...

Advantages : Increased productivity, can be used in multiple applications, prevents clogging, no contamination of the workpiece, even finish, prevents damage and burnt areas.

dimensions	density	code	type	max RPM	advised RPM	stock	
Ø 115x22	5 - soft	SAG/5/115	Sil. Carb.	10000	5000	●	5
	6 - medium	SAG/6/115	Sil. Carb.	10000	5000	●	5
	7 - medium	SAG/7/115	Sil. Carb.	10000	5000	●	5
	8 - hard	SAG/8/115	Sil. Carb.	10000	5000	●	5
Ø 125x22	5 - soft	SAG/5/125	Sil. Carb.	8000	4000	●	5
	6 - medium	SAG/6/125	Sil. Carb.	8000	4000	●	5
	7 - medium	SAG/7/125	Sil. Carb.	8000	4000	●	5
	8 - hard	SAG/8/125	Sil. Carb.	8000	4000	●	5



Keep it cool!



Always cool the workpiece sufficiently, prior to working it with unitized materials. Too high heat generation can cause the material to melt, and its excellent properties will go to waste.

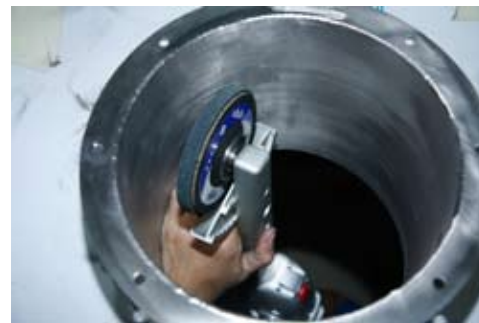

Tips & tricks : Cleaning surfaces

The SAG is the perfect disc to safely remove lacquer and limited amounts of rust from surfaces.

Unitized is a very forgiving material, allowing you to clean the surface without modifying the geometry of the surface. This is very important with workpieces for which tolerances have to be maintained to ensure that everything fits properly once the parts are cleaned.

The SAG allows you to clean the surface safely and efficiently, without damaging it.



INOX
STAINLESS

cibo

SAG

Ø 125 x 32mm
4 5/8" x 7/8"

HE
PRO
12

FIBRE DISCS

- Introduction 284
- Aluminium oxide 288
- Aluminium oxide with grinding aid 290
- Zirconium oxide 291
- Ceramic with grinding aid 293
- Silicon carbide 294
- Overview back-up pads 295



FIBRE DISCS

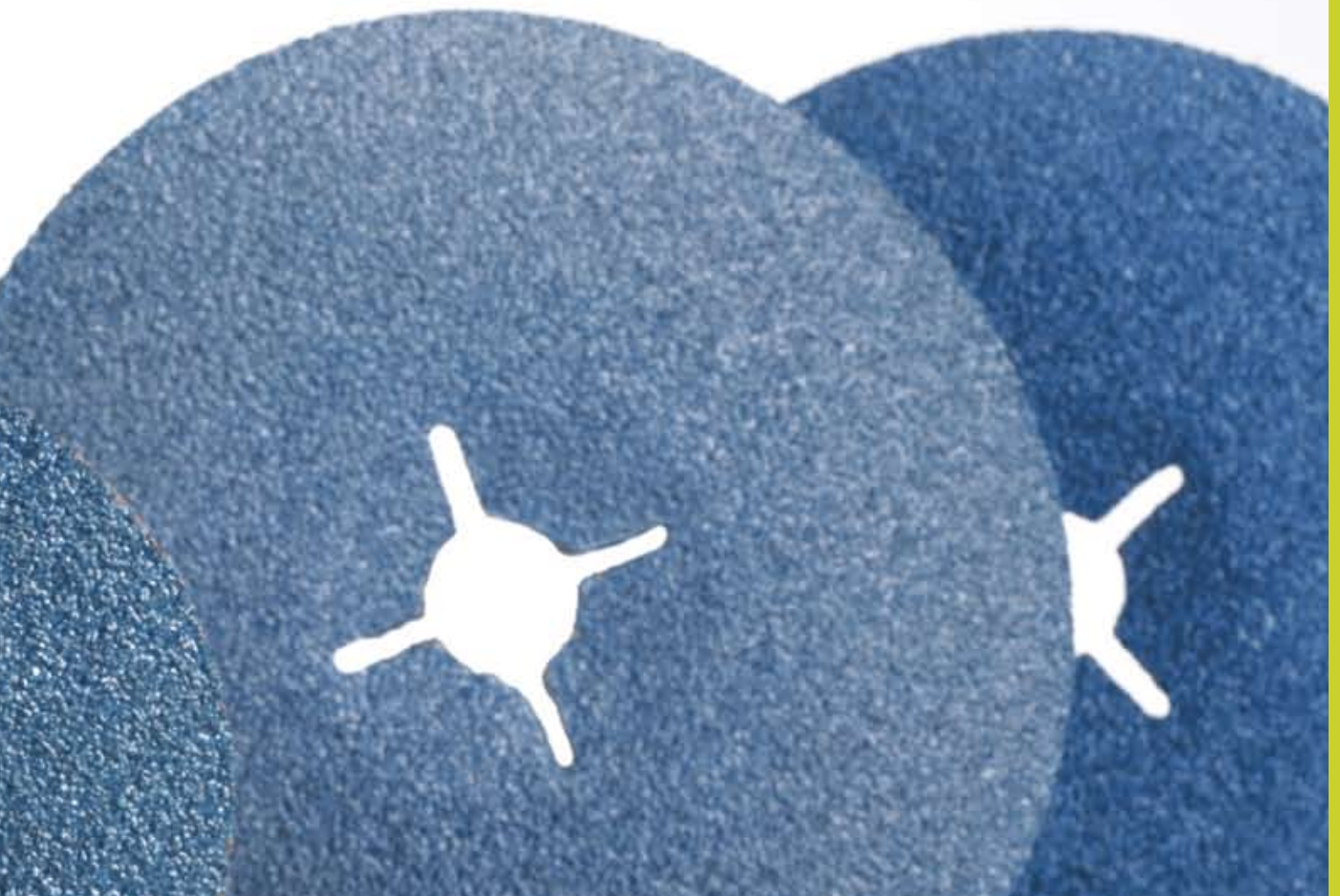



➤ BUILD-UP OF THE FIBRE DISC

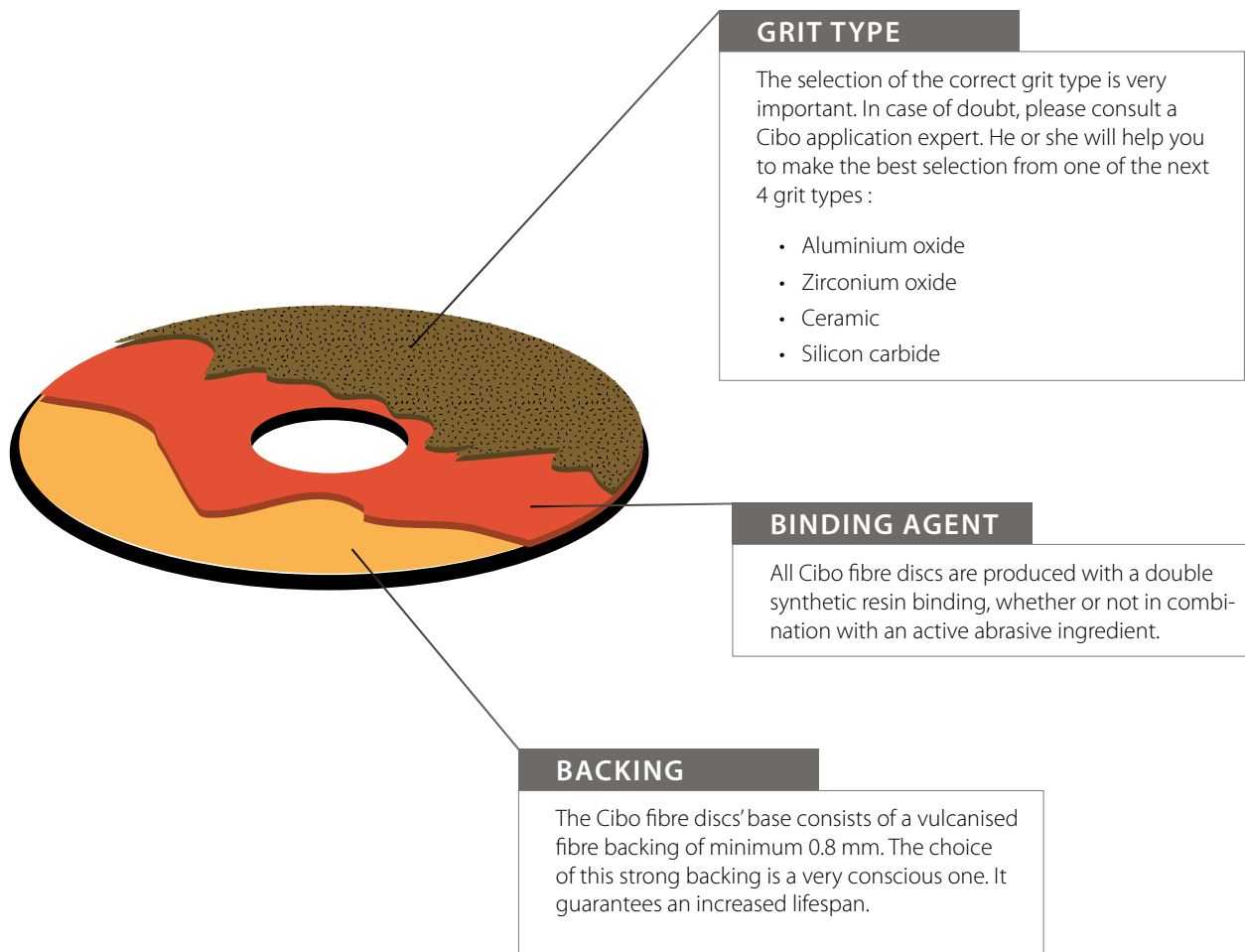



Working pressure

We advise against using too high pressure when using fibre discs. This causes heat generation, burnt areas and premature wear.

Maximum and advised speeds

The maximum speed for all Cibo fibre discs is 80 m/s.

The ideal circumferential speed depends on the material to be worked. It is always best to work at speeds lower than 60 m/s. With silicon carbide discs, it is better to set the speeds based on the material you want to work. Please note, these speeds are not absolute, they are only a guideline. When in doubt, please consult your Cibo advisor.



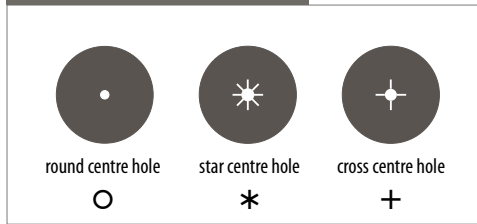



CENTRE HOLES



Prevent heat generation

By moving the disc smoothly back and forth you can considerably diminish the risk of burnt areas.

ADVICE ON USER SPEEDS (RPM)

	 Cast iron-Steel	 Stainless steel	 Alu-Non-ferrous metal Brass-Copper	 Hardened steel Titanium	 Glass-Stone Ceramic	 Plastics
Ø 115	7.100 - 8.200	4.900 - 5.700	4.500 - 5.100	4.000 - 4.600	2.500 - 2.900	900 - 1.200
Ø 125	6.500 - 7.500	4.500 - 5.200	4.100 - 4.700	3.700 - 4.200	2.300 - 2.700	800 - 1.100
Ø 178	4.500 - 5.200	3.200 - 3.700	2.900 - 3.300	2.600 - 3.000	1.600 - 1.900	600 - 800



FIZ



FIW



FIH

BACK-UP PADS

Fibre discs in combination with the correct back-up pad

Fibre discs must be used in combination with a back-up pad. The choice of back-up pad is important for the finish of your workpiece.

Please find an extensive overview of the different back-up pads of the Cibo product range on page 295.

Flexible back-up pad FIZ

Grinding with a soft contact. This guarantees a controlled removal and a finer finish. Ideally suited for use with finer grit types.

Hard back-up pad FIW

Grinding with a hard contact for a rapid and aggressive removal.

Hard back-up pad – *High performance* FIH

This high-performance back-up pad guarantees a hard and stable contact at all times due to its unique architecture. The ingenious composition of the disc ensures extreme heat resistance. The ribs preventing heat build-up ensure a cooler grinding process, whereby the back-up pad is not distorted under the influence of heat generation.



Please use a high-performance back-up pad up to grit 60 to make optimal use of the fibre disc's capabilities.



Tips & Tricks: Grit choice and back-up pads

For a rapid, aggressive removal of material, your best option is a grit type between 16 and 50.

A hard back-up pad is used for working flat surfaces. This also guarantees rapid removal of material. In order to grind bent and round shapes, and in order to achieve a better level of finish, your best option is a flexible back-up pad.



> Aluminium oxide

ALUMINIUM OXIDE



KF991

- Properties :**
- Base : fibre 0.8 mm
 - Grit type : aluminium oxide
- Applications :**
- Removing paints, primers, filler, etc.
 - Sanding old wooden floors and antique beams
 - General metal work

dimensions	grit	code	centre hole	stock	
Ø 115x22	16	KF/16/11522	*	●	25
	24	KF/24/11522	*	●	50
	36	KF/36/11522	*	●	50
	50	KF/50/11522	*	●	50
	60	KF/60/11522	*	●	50
	80	KF/80/11522	*	●	50
	100	KF/100/11522	*	●	50
	120	KF/120/11522	*	●	50
	150	KF/150/11522	*	●	50
	180	KF/180/11522	*	●	50
	220	KF/220/11522	*	●	50
	Ø 125x22	16	KF/16/12522	*	●
24		KF/24/12522	*	●	50
36		KF/36/12522	*	●	50
50		KF/50/12522	*	●	50
60		KF/60/12522	*	●	50
80		KF/80/12522	*	●	50
100		KF/100/12522	*	●	50
120		KF/120/12522	*	●	50
150		KF/150/12522	*	●	50
180		KF/180/12522	*	●	50
220		KF/220/12522	*	●	50
Ø 180x22		16	KF/16/18022	*	●
	24	KF/24/18022	*	●	25
	36	KF/36/18022	*	●	50
	50	KF/50/18022	*	●	50
	60	KF/60/18022	*	●	50
	80	KF/80/18022	*	●	50



KF991

dimensions	grit	code	centre hole	stock	
	100	KF/100/18022	*	●	50
	120	KF/120/18022	*	●	50
	150	KF/150/18022	*	●	50
	180	KF/180/18022	*	●	50
	220	KF/220/18022	*	●	50



 Overview back-up pads : see p. 295



● = available from stock

● = available in 5 working days

● = on request

ALUMINIUM OXIDE



> Aluminium oxide with grinding aid

KF995

- Properties :**
- Base : fibre 0,8 mm
 - Grit type : aluminium oxide + active grinding ingredient
- Applications :**
- Stainless steel, aluminium, hard steel types, special alloys

dimensions	grit	code	centre hole	stock	
Ø 115x22	36	K5/36/11522	*	●	50
	50	K5/50/11522	*	●	50
	60	K5/60/11522	*	●	50
	80	K5/80/11522	*	●	50
	100	K5/100/11522	*	●	50
	120	K5/120/11522	*	●	50
	150	K5/150/11522	*	●	50
Ø 125x22	36	K5/36/12522	*	●	50
	50	K5/50/12522	*	●	50
	60	K5/60/12522	*	●	50
	80	K5/80/12522	*	●	50
	100	K5/100/12522	*	●	50
	120	K5/120/12522	*	●	50
	150	K5/150/12522	*	●	50
Ø 180x22	36	K5/36/18022	*	●	50
	50	K5/50/18022	*	●	50
	60	K5/60/18022	*	●	50
	80	K5/80/18022	*	●	50
	100	K5/100/18022	*	●	50
	120	K5/120/18022	*	●	50
	150	K5/150/18022	*	●	50



The grinding aid ensures a cool grinding procedure and prevents burnt areas.

> Zirconium oxide

KF993 – INCREASED AGGRESSIVENESS

- Properties :**
- Base : fibre 0,8 mm
 - Grit type : zirconium oxide
- Applications :**
- Stainless steel, aluminium, chromium, special alloys, hard steel types, etc.

dimensions	grit	code	centre hole	stock	
Ø 115x22	24	K3/24/11522	*	●	50
	36	K3/36/11522	*	●	50
	50	K3/50/11522	*	●	50
	60	K3/60/11522	*	●	50
	80	K3/80/11522	*	●	50
	120	K3/120/11522	*	●	50
Ø 125x22	24	K3/24/12522	*	●	50
	36	K3/36/12522	*	●	50
	50	K3/50/12522	*	●	50
	60	K3/60/12522	*	●	50
	80	K3/80/12522	*	●	50
	120	K3/120/12522	*	●	50
Ø 180x22	24	K3/24/18022	*	●	25
	36	K3/36/18022	*	●	50
	50	K3/50/18022	*	●	50
	60	K3/60/18022	*	●	50
	80	K3/80/18022	*	●	50
	120	K3/120/18022	*	●	50

ZIRCONIUM OXIDE



 **Overview back-up pads :** see p. 295



Did you know the KF993 is the most popular disc in the stainless steel series?

● = available from stock

● = available in 5 working days

● = on request

ZIRCONIUM OXIDE



Zirconium oxide

DZ73

- Properties :**
- Base : fibre 0,8 mm
 - Grit type : zirconium oxide (high concentration)
- Applications :**
- Stainless steel, chromium, hard steel types, etc.
 - Suited for demanding applications

dimensions	grit	code	centre hole	stock	
Ø 115x22	24	DZ/24/11522	+	●	100
	36	DZ/36/11522	+	●	100
	50	DZ/50/11522	+	●	100
	60	DZ/60/11522	+	●	100
	80	DZ/80/11522	+	●	100
Ø 125x22	24	DZ/24/12522	+	●	100
	36	DZ/36/12522	+	●	100
	50	DZ/50/12522	+	●	100
	60	DZ/60/12522	+	●	100
	80	DZ/80/12522	+	●	100
Ø 180x22	24	DZ/24/18022	+	●	100
	36	DZ/36/18022	+	●	100
	50	DZ/50/18022	+	●	100
	60	DZ/60/18022	+	●	100
	80	DZ/80/18022	+	●	100



➤ Ceramic with grinding aid

DG65

- Properties :**
- Base : fibre 0.8 mm
 - Grit type : ceramic
- Applications :**
- Stainless steel, chromium, hard steel types, etc.
 - Ideally suited for demanding applications
 - Rapid and cool stock removal

dimensions	grit	code	centre hole	stock	
Ø 115x22	24	DG/24/11522	+	●	100
	36	DG/36/11522	+	●	100
	50	DG/50/11522	+	●	100
	60	DG/60/11522	+	●	100
	80	DG/80/11522	+	●	100
Ø 125x22	24	DG/24/12522	+	●	100
	36	DG/36/12522	+	●	100
	50	DG/50/12522	+	●	100
	60	DG/60/12522	+	●	100
	80	DG/80/12522	+	●	100
Ø 180x22	24	DG/24/18022	○	●	100
	36	DG/36/18022	○	●	100
	50	DG/50/18022	○	●	100
	60	DG/60/18022	○	●	100
	80	DG/80/18022	○	●	100

CERAMIC



 **Overview back-up pads : see p. 295**



● = available from stock

● = available in 5 working days

● = on request

> Silicon carbide

SILICON CARBIDE



DC82

- Properties :**
- Base : fibre 0.8 mm
 - Grit type : silicon carbide
- Applications :**
- Non-ferrous metals, cast iron, marble, granite, stone, concrete, etc.

dimensions	grit	code	centre hole	stock	
Ø 115x22	24	DC/24/11522	+	●	100
	36	DC/36/11522	+	●	100
	60	DC/60/11522	+	●	100
	80	DC/80/11522	+	●	100
	120	DC/120/11522	+	●	100
	150	DC/150/11522	+	●	100
	180	DC/180/11522	+	●	100
	220	DC/220/11522	+	●	100
	320	DC/320/11522	+	●	100
Ø 125x22	36	DC/36/12522	+	●	100
	60	DC/60/12522	+	●	100
	80	DC/80/12522	+	●	100
	120	DC/120/12522	+	●	100
	220	DC/220/12522	+	●	100
	320	DC/320/12522	+	●	100
Ø 180x22	16	DC/16/18022	○	●	50
	24	DC/24/18022	○	●	100
	36	DC/36/18022	○	●	100
	50	DC/50/18022	○	●	100
	60	DC/60/18022	○	●	100
	80	DC/80/18022	○	●	100
	120	DC/120/18022	○	●	100
	150	DC/150/18022	○	●	100
	180	DC/180/18022	○	●	100
	220	DC/220/18022	○	●	100
	320	DC/320/18022	○	●	100
400	DC/400/18022	○	●	100	

➤ Fibre disc back-up pads for angle grinder

HARD BACK-UP PAD

- Properties:**
- Grinding with hard contact
 - Faster and more aggressive material removal

diameter	attach- ment	code	stock	
Ø 115	M14	FIW115	●	1
Ø 125	M14	FIW125	●	1
Ø 171	M14	FIW178	●	1
Ø 218	M14	FIW230	●	1

HARD BACK-UP PAD



FLEXIBLE BACK-UP PAD

- Properties:**
- Grinding with soft contact
 - Controlled removal
 - Finer finish

diameter	attach- ment	code	stock	
Ø 115	M14	FIZ115	●	1
Ø 125	M14	FIZ125	●	1
Ø 171	M14	FIZ178	●	1
Ø 171	5/8"	FIZ179	●	1
Ø 218	M14	FIZ230	●	1

FLEXIBLE BACK-UP PAD



HARD BACK-UP PAD - HIGH PERFORMANCE

- Properties:**
- Ventilated back-up pads
 - Guarantee a hard and stable contact at all times
 - Extremely heat-resistant

diameter	attach- ment	code	stock	
Ø 115	M14	FIH115	●	1
Ø 125	M14	FIH125	●	1
Ø 171	M14	FIH178	●	1

HARD BACK-UP PAD (HP)



● = available from stock

● = available in 5 working days

● = on request

QUICK CHANGE

● General Info	298
● Socatt®	300
○ Aluminium oxide	300
○ Zirconium oxide	302
○ Ceramic	304
○ Silicon carbide	305
○ Tex	305
○ Surface conditioning	306
○ Unitized	307
● Lockit®/Roloc®	308
○ Aluminium oxide	308
○ Zirconium oxide	309
○ Ceramic	310
○ Tex	311
○ Surface conditioning	311
○ Unitized	312
● Overview supports	313



Cibo will very quickly produce for you any size, grade or grit that is not listed in the overview.
After all, customisation is the norm at Cibo.

Socatt®, Lockit® and Roloc® are brandnames of the 3M Company.





QUICK CHANGE



> GENERAL INFO

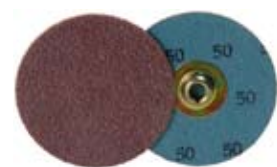

SOCATT®

Socatt® discs have a metal attachment plate on the disc and a quick change mechanism in the support. Socatt® guarantees a safe and durable attachment. You can change a disc in no time. Socatt® is the most popular quick change system worldwide. All Socatt® quick change discs are adaptable to all Speed-Lock supports.



LOCKIT® / ROLOC®

The Lockit® / Roloc® discs are provided with a nylon disc with a screw thread. This screw thread fits into the attachment system of the support. These discs fit on all Lockit® and Roloc® supports. You can easily exchange a disc with half a turn.

Socatt®, Lockit® and Roloc® are brandnames of the 3M Company.



QUART-DE-TOUR

All grades and grit dimensions are also available with a Quart-de-tour connection. Do you have any specific requests or wishes? Please let us know; Cibo can produce the Quart-de-tour discs for you very quickly.



Benefits

- Firm attachment of the discs
- The diameter of the disc and flexibility of the support allow for accurate working
- Can be changed very quickly
- Due to the large variety of discs and supports, we can provide the correct grinding disc for each application
- Use of adapted discs guarantees a longer lifespan
- The disc is always centred on the support

To be mounted on





To be used on angle grinders, drills and machines with flexible shafts.

Build up of the discs

Quick Change discs are laminated and the bases are usually built of several layers (2ply = 2 layers). This has the advantage that they have a much longer lifespan, and a more rapid removal of material can be guaranteed. Laminated discs may be used under very high pressure and resistance.

ADVICE ON USER SPEEDS (RPM)

! Never exceed the max. speed of the support!

		 Cast iron-Steel	 Stainless steel	 Alu-Non-ferrous metal Brass-Copper	 Titanium-Cobalt Alloys
General	Ø 25	19,000-25,000	16,000-20,000	12,000-16,000	8,000-12,000
	Ø 38	12,500-15,000	10,000-12,500	7,500-10,000	5,000-7,500
	Ø 50	10,000-12,000	7,500-9,500	5,500-7,500	4,000-5,500
	Ø 75	6,500-7,500	5,000-6,500	3,500-5,000	2,500-3,500
Reinforced Tex	Ø 25	–	13,600-17,000	10,200-13,600	6,800-10,200
	Ø 50	–	6,375-8,000	4,700-6,300	3,400-4,600
	Ø 75	–	4,250-5,500	2,900-4,300	2,100-2,900



ALUMINIUM OXIDE

ALUMINIUM OXIDE 2ply



- Applications :**
- Grinding down pointed welds, unevenness and damage
 - Can be used on all ferrous metals

diameter	grit	code	max RPM	stock	
Ø 19	80	QSAO/80/19	40.000	●	100
	120	QSAO/120/19	40.000	●	100
Ø 25	24	QSAO/24/25	40.000	●	100
	36	QSAO/36/25	40.000	●	100
	50	QSAO/50/25	40.000	●	100
	60	QSAO/60/25	40.000	●	100
	80	QSAO/80/25	40.000	●	100
	120	QSAO/120/25	40.000	●	100
	240	QSAO/240/25	40.000	●	100
Ø 38	24	QSAO/24/38	25.000	●	100
	36	QSAO/36/38	25.000	●	100
	50	QSAO/50/38	25.000	●	100
	60	QSAO/60/38	25.000	●	100
	80	QSAO/80/38	25.000	●	100
	120	QSAO/120/38	25.000	●	100
	240	QSAO/240/38	25.000	●	100
Ø 50	24	QSAO/24/50	25.000	●	100
	36	QSAO/36/50	25.000	●	100
	50	QSAO/50/50	25.000	●	100
	60	QSAO/60/50	25.000	●	100
	80	QSAO/80/50	25.000	●	100
	120	QSAO/120/50	25.000	●	100
	240	QSAO/240/50	25.000	●	100
Ø 75	320	QSAO/320/50	25.000	●	100
	24	QSAO/24/75	20.000	●	50
	36	QSAO/36/75	20.000	●	50
	50	QSAO/50/75	20.000	●	50
	60	QSAO/60/75	20.000	●	50
	80	QSAO/80/75	20.000	●	50
	120	QSAO/120/75	20.000	●	50
	240	QSAO/240/75	20.000	●	50

Socatt®

ALUMINIUM OXIDE XTRA – WITH ACTIVE GRINDING INGREDIENT 2ply

ALUMINIUM OXIDE

Properties : Dirt-repellent with heat-resistant additive

Applications : This grade, XTRA, grinds cooler and faster and provides excellent results on aluminium, nickel and chromium

diameter	grit	code	max RPM	stock	
Ø 50	36	QSAX/36/50	25.000	●	100
	50	QSAX/50/50	25.000	●	100
	60	QSAX/60/50	25.000	●	100
	80	QSAX/80/50	25.000	●	100
	120	QSAX/120/50	25.000	●	100
Ø 75	36	QSAX/36/75	20.000	●	50
	60	QSAX/60/75	20.000	●	50
	80	QSAX/80/75	20.000	●	50
	120	QSAX/120/75	20.000	●	50



 Overview supports : see p. 313



● = available from stock

● = available in 5 working days

● = on request

> Socatt®

ALUMINIUM OXIDE



ALUMINIUM OXIDE ON FIBRE

Properties: Retains its shape better, with less wear and harder contact than the 2PLY

Applications: Grinding down weld seams, burrs and imperfections

diameter	grit	code	max RPM	stock	
Ø 50	36	QSFA/36/50	25.000	●	100
	60	QSFA/60/50	25.000	●	100
	80	QSFA/80/50	25.000	●	100
Ø 75	36	QSFA/36/75	20.000	●	50
	60	QSFA/60/75	20.000	●	50
	80	QSFA/80/75	20.000	●	50

ZIRCONIUM OXIDE



ZIRCONIUM OXIDE 2ply

Properties: Abrasion-resistant, hard grit type

Applications: Mainly working stainless steel

diameter	grit	code	max RPM	stock	
Ø 50	36	QSNO/36/50	20.000	●	100
	50	QSNO/50/50	20.000	●	100
	60	QSNO/60/50	20.000	●	100
	80	QSNO/80/50	20.000	●	100
Ø 75	120	QSNO/120/50	20.000	●	100
	36	QSNO/36/75	12.000	●	50
	50	QSNO/50/75	12.000	●	50
	60	QSNO/60/75	12.000	●	50
	80	QSNO/80/75	12.000	●	50
	120	QSNO/120/75	12.000	●	50



Please consult Cibo for other sizes, qualities and grits.

> Socatt®

WITH GRINDING AID 2ply

Properties : With heat-resistant additive

Applications : Ideally suited to work stainless steel, titanium alloys, etc.

diameter	grit	code	max RPM	stock	
Ø 38	36	QSPZ/36/38	25.000	●	100
	60	QSPZ/60/38	25.000	●	100
	80	QSPZ/80/38	25.000	●	100
	120	QSPZ/120/38	25.000	●	100
Ø 50	36	QSPZ/36/50	25.000	●	100
	60	QSPZ/60/50	25.000	●	100
	80	QSPZ/80/50	25.000	●	100
	120	QSPZ/120/50	25.000	●	100
Ø 75	36	QSPZ/36/75	20.000	●	50
	60	QSPZ/60/75	20.000	●	50
	80	QSPZ/80/75	20.000	●	50
	120	QSPZ/120/75	20.000	●	50

ZIRCONIUM OXIDE

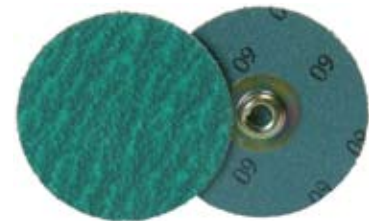

 **Overview supports :** see p. 313



Socatt®, Lockit® and Roloc® are brandnames of the 3M Company.

● = available from stock

● = available in 5 working days

● = on request

ZIRCONIUM OXIDE



> Socatt®

MINIFLAP – ZIRCONIUM OXIDE

- Properties :** The properties of a flap disc are now also available in quick-change:
- Longer lifespan
 - Less frequent disc replacements
 - Overlapping flaps ensure a better resistance to angles
 - Less heat generation
 - Greater accessibility

diameter	grit	code	max RPM	stock	
Ø 50	40	MSZV/40/50	15.000	●	10
	60	MSZV/60/50	15.000	●	10
	80	MSZV/80/50	15.000	●	10
	120	MSZV/120/50	15.000	●	10
Ø 75	40	MSZV/40/75*	10.000	●	10
	60	MSZV/60/75*	10.000	●	10
	80	MSZV/80/75*	10.000	●	10
	120	MSZV/120/75*	10.000	●	10

(*) Caution! Use Ø75 only with support **QSRH/M/75M14/MF**. See p. 313

CERAMIC



CERAMIC – WITH GRINDING AID 2ply

- Applications :** Best choice for stock removal of hard steel and exotic steel alloys
- Properties :**
- Ceramic grit type
 - Top coating for cooler grinding
 - High pressure is required

diameter	grit	code	max RPM	stock	
Ø 50	24	QSPP/24/50	20.000	●	100
	36	QSPP/36/50	20.000	●	100
	40	QSPP/40/50	20.000	●	100
	60	QSPP/60/50	20.000	●	100
	80	QSPP/80/50	20.000	●	100
Ø 75	24	QSPP/24/75	12.000	●	50
	36	QSPP/36/75	12.000	●	50
	40	QSPP/40/75	12.000	●	50
	60	QSPP/60/75	12.000	●	50
	80	QSPP/80/75	12.000	●	50



Advantages:

- Faster material removal, combined with a long lifespan and amazing resistance to burrs and angles.
- Unbeatable in terms of aggressiveness and lifespan!

Socatt®

SILICON CARBIDE 2ply

Applications : Working titanium, cast iron, bronze, stone, rubber, plastics and non-ferrous metals

diameter	grit	code	max RPM	stock	
Ø 50	36	QSSC/36/50	25.000	●	100
	60	QSSC/60/50	25.000	●	100
	80	QSSC/80/50	25.000	●	100
	120	QSSC/120/50	25.000	●	100
	240	QSSC/240/50	25.000	●	100
Ø 75	36	QSSC/36/75	20.000	●	50
	60	QSSC/60/75	20.000	●	50
	80	QSSC/80/75	20.000	●	50
	120	QSSC/120/75	20.000	●	50
	240	QSSC/240/75	20.000	●	50

SILICON CARBIDE



 **Overview supports :** see p. 313

TEX 2ply

Applications : Removing, refining and improving surface errors, minor oxidation, primary rust, primary burrs, casting errors, residue on moulds, structured surfaces, etc.

diameter	grit	code	max RPM	stock	
Ø 50	ME	QSBB/M/50	12.000	●	50
	F	QSBB/F/50	12.000	●	50
	VF	QSBB/VF/50	12.000	●	50
Ø 75	ME	QSBB/M/75	8.000	●	25
	F	QSBB/F/75	8.000	●	25
	VF	QSBB/VF/75	8.000	●	25

TEX



 Never exceed the maximum rpm! For the speed recommended by Cibo, see p. 299

 **ME = Medium - F = Fine - VF = Very Fine**

● = available from stock

● = available in 5 working days

● = on request

SURFACE CONDITIONING





> Socatt®

REINFORCED TEX - SURFACE CONDITIONING

Applications : Removing and refining minor burrs, weld spatter, milling lines, minor damage, grinding lines, paint, coatings, seals, glue, weld seams, etc.

diameter	grit	code	max RPM	stock	
Ø 19	CO	QSVT/ST1/19	18.000	●	50
	ME	QSVT/ST2/19	18.000	●	50
	VF	QSVT/ST3/19	18.000	●	50
Ø 25	CO	QSVT/ST1/25	15.000	●	50
	ME	QSVT/ST2/25	15.000	●	50
	VF	QSVT/ST3/25	15.000	●	50
Ø 50	CO	QSVT/ST1/50	12.000	●	50
	ME	QSVT/ST2/50	12.000	●	50
	VF	QSVT/ST3/50	12.000	●	50
Ø 75	CO	QSVT/ST1/75	10.000	●	25
	ME	QSVT/ST2/75	10.000	●	25
	VF	QSVT/ST3/75	10.000	●	25

 **Overview supports :** see p. 313

 Never exceed the maximum rpm! For the speed recommended by Cibo, see p. 299

 CO = Coarse - ME = Medium - VF = Very Fine



➤ Socatt®

UNITIZED

- Applications :**
- For applications in which the contact surface of the disc has to be relatively small, or where the control of the grinding activity is important
 - Weld discolourations
 - Removing milling lines
 - Improving surface roughness

diameter	thick-ness	density	code	max RPM	stock		
Ø 50	3	7 - medium	QSSA/7/503	18.000	●	10	
	3	8 - hard	QSSA/8/503	18.000	●	10	
	3	10 - hard	QSSA/10/503	18.000	●	10	
	6	5 - soft	QSSA/5/506	18.000	●	10	
	6	6 - medium	QSSA/6/506	18.000	●	10	
	6	7 - medium	QSSA/7/506	18.000	●	10	
	6	8 - hard	QSSA/8/506	18.000	●	10	
	6	10 - hard	QSSA/10/506	18.000	●	10	
	Ø 75	3	7 - medium	QSSA/7/753	12.000	●	10
		3	8 - hard	QSSA/8/753	12.000	●	10
3		10 - hard	QSSA/10/753	12.000	●	10	
6		5 - soft	QSSA/5/756	12.000	●	10	
6		6 - medium	QSSA/6/756	12.000	●	10	
6		7 - medium	QSSA/7/756	12.000	●	10	
6		8 - hard	QSSA/8/756	12.000	●	10	
6		10 - hard	QSSA/10/756	12.000	●	10	

UNITIZED



● = available from stock

● = available in 5 working days

● = on request

ALUMINIUM OXIDE





> Lockit® / Roloc®

ALUMINIUM OXIDE 2ply

- Applications :**
- Grinding down pointed welds, unevenness and damage
 - Can be used on all ferrous metals

diameter	grit	code	max RPM	stock	
Ø 25	36	QLAO/36/25	40.000	●	100
	50	QLAO/50/25	40.000	●	100
	60	QLAO/60/25	40.000	●	100
	80	QLAO/80/25	40.000	●	100
	120	QLAO/120/25	40.000	●	100
Ø 38	36	QLAO/36/38	25.000	●	100
	50	QLAO/50/38	25.000	●	100
	60	QLAO/60/38	25.000	●	100
	80	QLAO/80/38	25.000	●	100
	120	QLAO/120/38	25.000	●	100
Ø 50	36	QLAO/36/50	25.000	●	100
	50	QLAO/50/50	25.000	●	100
	60	QLAO/60/50	25.000	●	100
	80	QLAO/80/50	25.000	●	100
	120	QLAO/120/50	25.000	●	100
Ø 75	36	QLAO/36/75	20.000	●	50
	50	QLAO/50/75	20.000	●	50
	60	QLAO/60/75	20.000	●	50
	80	QLAO/80/75	20.000	●	50
	120	QLAO/120/75	20.000	●	50

 **Overview supports :** see p. 313

 Please consult Cibo for other sizes, qualities and grits.

Lockit® / Roloc®

ALUMINIUM OXIDE ON FIBRE

Properties: Retains its shape better, with less wear and harder contact than the 2PLY

Applications: Grinding down weld seams, burrs and imperfections

diameter	grit	code	max RPM	stock	
Ø 50	36	QLFA/36/50	25.000	●	100
	60	QLFA/60/50	25.000	●	100
	80	QLFA/80/50	25.000	●	100
Ø 75	36	QLFA/36/75	20.000	●	50
	60	QLFA/60/75	20.000	●	50
	80	QLFA/80/75	20.000	●	50

ALUMINIUM OXIDE



ZIRCONIUM OXIDE – WITH GRINDING AID 2ply

Properties: Heat resistant additive

Applications: Ideally suited for working stainless steel, titanium alloys, etc.

diameter	grit	code	max RPM	stock	
Ø 38	36	QLPZ/36/38	25.000	●	100
	60	QLPZ/60/38	25.000	●	100
	80	QLPZ/80/38	25.000	●	100
	120	QLPZ/120/38	25.000	●	100
Ø 50	36	QLPZ/36/50	25.000	●	100
	60	QLPZ/60/50	25.000	●	100
	80	QLPZ/80/50	25.000	●	100
	120	QLPZ/120/50	25.000	●	100
Ø 75	36	QLPZ/36/75	20.000	●	50
	60	QLPZ/60/75	20.000	●	50
	80	QLPZ/80/75	20.000	●	50
	120	QLPZ/120/75	20.000	●	50

ZIRCONIUM OXIDE



Socatt®, Lockit® and Roloc® are brandnames of the 3M Company.

● = available from stock

● = available in 5 working days

● = on request

ZIRCONIUM OXIDE



> Lockit® / Roloc®

MINIFLAP – ZIRCONIUM OXIDE

- Properties :** The properties of a flap disc are now also available in quick-change:
- Longer lifespan
 - Less frequent disc replacements
 - Overlapping flaps ensure a better resistance to angles
 - Less heat generation
 - Greater accessibility

diameter	grit	code	max RPM	stock	
Ø 50	40	MLZV/40/50	15.000	●	10
	60	MLZV/60/50	15.000	●	10
	80	MLZV/80/50	15.000	●	10
	120	MLZV/120/50	15.000	●	10
Ø 75	40	MLZV/40/75	10.000	●	10
	60	MLZV/60/75	10.000	●	10
	80	MLZV/80/75	10.000	●	10
	120	MLZV/120/75	10.000	●	10

CERAMIC



CERAMIC – WITH GRINDING AID

- Applications :** Best choice for heavy stock removal of steel and stainless steel
- Properties :**
- Ceramic grit type
 - Top coating for cooler grinding
 - High pressure is required

diameter	grit	code	max RPM	stock	
Ø 50	24	QLPP/24/50	20.000	●	100
	36	QLPP/36/50	20.000	●	100
	40	QLPP/40/50	20.000	●	100
	60	QLPP/60/50	20.000	●	100
	80	QLPP/80/50	20.000	●	100
Ø 75	24	QLPP/24/75	12.000	●	50
	40	QLPP/40/75	12.000	●	50
	60	QLPP/60/75	12.000	●	50
	80	QLPP/80/75	12.000	●	50



Advantages:

- Faster material removal, combined with a long lifespan and amazing resistance to burrs and angles.
- Unbeatable in terms of aggressiveness and lifespan!

Lockit® / Roloc®

TEX 2ply

Applications : Removing, refining and improving minor oxidation, primary rust, primary burrs, casting errors, errors in moulds, surfaces, etc.

diameter	grit	code	max RPM	stock	
Ø 50	ME	QLBB/M/50	12.000	●	50
	F	QLBB/F/50	12.000	●	50
	VF	QLBB/VF/50	12.000	●	50
Ø 75	ME	QLBB/M/75	8.000	●	25
	F	QLBB/F/75	8.000	●	25
	VF	QLBB/VF/75	8.000	●	25

TEX



i CO = Coarse - ME = Medium - F = Fine - VF = Very Fine

REINFORCED TEX - SURFACE CONDITIONING 2ply

Applications : Removing and refining minor burrs, weld spatter, milling lines, minor damage, grinding lines, oxidation, paint, coatings, seals, glue, weld seams, etc.

diameter	grit	code	max RPM	stock	
Ø 50	CO	QLVT/ST1/50	12.000	●	50
	ME	QLVT/ST2/50	12.000	●	50
	VF	QLVT/ST3/50	12.000	●	50
Ø 75	CO	QLVT/ST1/75	10.000	●	25
	ME	QLVT/ST2/75	10.000	●	25
	VF	QLVT/ST3/75	10.000	●	25

SURFACE CONDITIONING



i Overview supports : see p. 313

! Never exceed the maximum rpm! For the speed recommended by Cibo, see p. 299

● = available from stock

● = available in 5 working days

● = on request

> Lockit® / Roloc®

UNITIZED



UNITIZED

- Applications :**
- For applications in which the contact surface of the disc has to be relatively small, or where the control of the grinding activity is important
 - Weld discolourations
 - Removing milling lines
 - Improving surface roughness

diameter	thick-ness	density	code	max RPM	stock	
Ø 50	3	7 - medium	QLSA/7/503	18.000	●	10
	3	8 - hard	QLSA/8/503	18.000	●	10
	3	10 - hard	QLSA/10/503	18.000	●	10
	6	5 - soft	QLSA/5/506	18.000	●	10
	6	6 - medium	QLSA/6/506	18.000	●	10
	6	7 - medium	QLSA/7/506	18.000	●	10
	6	8 - hard	QLSA/8/506	18.000	●	10
	6	10 - hard	QLSA/10/506	18.000	●	10
Ø 75	3	7 - medium	QLSA/7/753	12.000	●	10
	3	8 - hard	QLSA/8/753	12.000	●	10
	3	10 - hard	QLSA/10/753	12.000	●	10
	6	5 - soft	QLSA/5/756	12.000	●	10
	6	6 - medium	QLSA/6/756	12.000	●	10
	6	7 - medium	QLSA/7/756	12.000	●	10
	6	8 - hard	QLSA/8/756	12.000	●	10
	6	10 - hard	QLSA/10/756	12.000	●	10

Lockit® / Roloc® supports

LOCKIT® / ROLOC® HEAT-RESISTANT

diameter	density	diameter shaft	attach-ment	code	max RPM	stock	
Ø 25	medium	Ø 6	-	QLHO/M/256	40000	●	1
Ø 38	hard	Ø 6	-	QLHO/H/386	25000	●	1
Ø 38	medium	Ø 6	-	QLHO/M/386	25000	●	1
Ø 38	soft	Ø 6	-	QLHO/S/386	25000	●	1
Ø 50	hard	Ø 6	-	QLHO/H/506	25000	●	1
Ø 50	medium	Ø 6	-	QLHO/M/506	25000	●	1
Ø 50	soft	Ø 6	-	QLHO/S/506	25000	●	1
Ø 75	hard	Ø 6	-	QLHO/H/756	20000	●	1
Ø 75	medium	Ø 6	-	QLHO/M/756	20000	●	1
Ø 75	soft	Ø 6	-	QLHO/S/756	20000	●	1
Ø 50	medium	-	M14	QLRH/M/50M14	25000	●	1
Ø 75	medium	-	M14	QLRH/M/75M14	20000	●	1

Socatt®, Lockit® and Roloc® are brandnames of the 3M Company.

Socatt® supports

SOCATT® HEAT-RESISTANT

diameter	density	diameter shaft	attach-ment	code	max RPM	stock	
Ø 19	medium	Ø 6	-	QSHO/M/196	40000	●	1
Ø 25	medium	Ø 6	-	QSHO/M/256	40000	●	1
Ø 38	hard	Ø 6	-	QSHO/H/386	25000	●	1
Ø 38	medium	Ø 6	-	QSHO/M/386	25000	●	1
Ø 38	soft	Ø 6	-	QSHO/S/386	25000	●	1
Ø 50	hard	Ø 6	-	QSHO/H/506	25000	●	1
Ø 50	medium	Ø 6	-	QSHO/M/506	25000	●	1
Ø 50	soft	Ø 6	-	QSHO/S/506	25000	●	1
Ø 75	hard	Ø 6	-	QSHO/H/756	20000	●	1
Ø 75	medium	Ø 6	-	QSHO/M/756	20000	●	1
Ø 75	soft	Ø 6	-	QSHO/S/756	20000	●	1
Ø 50	medium	-	M14	QSRH/M/50M14	25000	●	1
Ø 75	medium	-	M14	QSRH/M/75M14	25000	●	1
Ø 75	medium	-	M14	QSRH/M/75M14/MF*	25000	●	1



* The Socatt® Miniflap, diameter of 75mm (see p. 304), only to be used in combination with this special back-up pad!

● = available from stock

● = available in 5 working days

● = on request

LOCKIT® / ROLOC®



SOCATT®



CUTTING AND GRINDING DISCS

- **Cutting discs** 316
 - Top line 316
 - Standard line 317
- **Grinding discs** 318
 - Top line 318
 - Ceramax 319



CUTTING AND GRINDING DISCS

TOP LINE CUTTING DISCS

The superior Cibo TOP LINE cutting discs enjoy an extremely long lifespan and cuts as fast as lightning. As these discs are entirely free of iron and sulphates, they are ideally suited for cutting stainless steel, practically without any burring. The ultra thin version of the disc allows you to work extremely precisely. With our TOP LINE range you will obtain the fastest and most durable disc in one swoop. Choose the best discs on the market and you are choosing to improve the comfort of your employees and manage your company's costs!

BENEFITS

- Extremely quick
- Very durable
- Super thin
- Burr-free cutting
- Entirely free from iron and sulphates, i.e. suited for cutting stainless steel
- Increases your comfort
- Cost management
- Extremely safe



TOP LINE



SNIN – TOP LINE

diameter	centre hole	thickness	code	stock	
Ø 100	16	1	SNIN100	●	25
Ø 115	22,2	1	SNIN1150	●	25
Ø 125	22,2	1	SNIN1250	●	25
Ø 115	22,2	1,6	SNIN1156	●	25
Ø 125	22,2	1,6	SNIN1256	●	25
Ø 180	22,2	2	SNIN180	●	25
Ø 230	22,2	2	SNIN230	●	25
Ø 230	22,2	2,5	SNIN23025	●	25

> Cutting discs

SNST – STANDARD LINE

diameter	centre hole	thickness	code	stock	
Ø 115	22,2	1	SNST1150	●	25
Ø 125	22,2	1	SNST1250	●	25
Ø 115	22,2	1,6	SNST1156	●	25
Ø 125	22,2	1,6	SNST1256	●	25
Ø 115	22,2	2,5	SNST11525	●	25
Ø 125	22,2	2,5	SNST12525	●	25
Ø 230	22,2	2,5	SNST23025	●	25
Ø 230	22,2	3	SNST23030	●	25

STANDARD LINE



For other references: contact CIBO.

● = available from stock

● = available in 5 working days

● = on request

➤ TOP LINE GRINDING DISCS

The secret of the TOP LINE grinding discs is the unique composition of the bond. Tests show that the Cibo grinding discs allow you to remove considerably more material in less time, resulting in an amazing price/quality ratio. The discs' soft bond ensures a high level of aggressiveness as well as making them very user friendly, because vibrations in the material are reduced to a minimum. Try the TOP LINE grinding discs and let yourself be convinced by their ease of use.

BENEFITS

- More material removed in less time
- Amazing price/quality ratio
- High level of abrasiveness
- Very user friendly
- Very low-noise
- Entirely free from iron and sulphates, i.e. ideal for working stainless steel



TOP LINE



SLIN – TOP LINE

diameter	centre hole	thickness	code	stock	
Ø 115	22,2	6,5	SLIN115	●	10
Ø 125	22,2	6,5	SLIN125	●	10
Ø 180	22,2	7	SLIN180	●	10
Ø 230	22,2	7	SLIN230	●	10

CERAMAX

Cibo introduces the Ceramax, a disc specifically developed for quick stock removal of a.o. stainless steel, aluminium and high-grade alloys. It consists of 100% ceramic grit and a high-tech bond.



BENEFITS

- Rapid stock removal
- High finish
- Cooler grinding
- Lower vibrations
- Lower noise generation
- Very long lifespan

RCM – 100% CERAMIC

diameter	centre hole	code	stock	
Ø 115	22,2	RCM/36/115	●	25
Ø 125	22,2	RCM/36/125	●	25
Ø 180	22,2	RCM/36/180	●	25

CERAMAX



Due to the high-quality finish, the Ceramax is the ideal disc to grind down weld seams and afterwards, without requiring any follow-up treatment, powder coat.



● = available from stock

● = available in 5 working days

● = on request

GRINDING WHEELS

- | | |
|---------------------------|-----|
| ● With centre hole | 322 |
| ○ Cloth | 322 |
| ○ Tex | 326 |
| ○ CSD | 329 |
| ○ Combi | 330 |
| ○ Convolute | 332 |
| ○ Unitized | 334 |
| ● Spindle mounted | 338 |
| ○ Cloth | 338 |
| ○ Tex | 342 |
| ○ Combi | 345 |
| ○ CSD | 348 |
| ○ Unitized | 349 |



Cibo can also rapidly manufacture any sizes, grades or grit types that are not listed in the overview.
After all, customisation is the norm at Cibo.



GRINDING WHEELS



> Cloth flap wheels

CLOTH ABRASIVES



WITH CENTRE HOLE

Properties:

- Soft working
- Much finer finish in comparison with grinding stones
- Cooler grinding
- A lot of material can be removed

To be mounted on:

- Stationary machines: e.g. grinding and polishing mills
- Wheels Ø 165 mm: heavy industrial machines with flexible shafts

diam.	width	spindle diam.	grit	code	max RPM	stock	
Ø 165	30	Ø 54	40	LA/40/16530	5.700	●	5
	30	Ø 54	60	LA/60/16530	5.700	●	5
	30	Ø 54	80	LA/80/16530	5.700	●	5
	30	Ø 54	100	LA/100/16530	5.700	●	5
	30	Ø 54	120	LA/120/16530	5.700	●	5
	30	Ø 54	150	LA/150/16530	5.700	●	5
	30	Ø 54	180	LA/180/16530	5.700	●	5
	30	Ø 54	220	LA/220/16530	5.700	●	5
	30	Ø 54	320	LA/320/16530	5.700	●	5
	50	Ø 54	40	LA/40/16550	5.700	●	3
	50	Ø 54	60	LA/60/16550	5.700	●	3
	50	Ø 54	80	LA/80/16550	5.700	●	3
	50	Ø 54	100	LA/100/16550	5.700	●	3
	50	Ø 54	120	LA/120/16550	5.700	●	3
	50	Ø 54	180	LA/180/16550	5.700	●	3
	50	Ø 54	220	LA/220/16550	5.700	●	3
50	Ø 54	320	LA/320/16550	5.700	●	3	
Ø 200	50	Ø 54	40	LA/40/20050	3.000	●	3
	50	Ø 54	60	LA/60/20050	3.000	●	3
	50	Ø 54	80	LA/80/20050	3.000	●	3
	50	Ø 54	100	LA/100/20050	3.000	●	3
	50	Ø 54	120	LA/120/20050	3.000	●	3
	50	Ø 54	180	LA/180/20050	3.000	●	3
	50	Ø 54	220	LA/220/20050	3.000	●	3
	50	Ø 54	320	LA/320/20050	3.000	●	3



Reducing flanges: see p. 482





WITH CENTRE HOLE

diam.	width	spindle diam.	grit	code	max RPM	stock	
Ø 250	50	Ø 101	60	LA/60/25050	2.800	●	3
	50	Ø 101	80	LA/80/25050	2.800	●	3
	50	Ø 101	120	LA/120/25050	2.800	●	3
	50	Ø 101	220	LA/220/25050	2.800	●	3



Tips & tricks: Cloth grinding wheels

- If you work with a laminated grinding wheel, then choose two grit types coarser than the ones you would normally use when working with grinding belts.
- The aggression of the grinding wheel is determined mainly by circumferential speed.
- The level of finish is improved by increasing the speed or by selecting a finer grit type at the same speed.
- By the use of a finer grit type and by decreasing the speed, the cutting capacity is improved, while the level of finish is upheld.



● = available from stock

● = available in 5 working days

● = on request

> Cloth flap wheels

CLOTH ABRASIVES



FINIMASTER BASIC AND OTHER SATINISING MACHINES

- Applications:**
- Grinding
 - Roughing
 - Cleaning
 - Satinising
 - Deburring

To be mounted on: Finimaster Basic and other satinising machines

diam.	width	spindle diam.	grit	code	max RPM	stock	
Ø 100	50	Ø 19,6	24	FMLA/24/10050	5.700	●	2
	50	Ø 19,6	40	FMLA/40/10050	5.700	●	2
	50	Ø 19,6	60	FMLA/60/10050	5.700	●	2
	50	Ø 19,6	80	FMLA/80/10050	5.700	●	2
	50	Ø 19,6	120	FMLA/120/10050	5.700	●	2
	50	Ø 19,6	180	FMLA/180/10050	5.700	●	2
	50	Ø 19,6	240	FMLA/240/10050	5.700	●	2
	50	Ø 19,6	320	FMLA/320/10050	5.700	●	2
	50	Ø 19,6	400	FMLA/400/10050	5.700	●	2
	100	Ø 19,6	24	FMLA/24/100100	5.700	●	1
	100	Ø 19,6	40	FMLA/40/100100	5.700	●	1
	100	Ø 19,6	60	FMLA/60/100100	5.700	●	1
	100	Ø 19,6	80	FMLA/80/100100	5.700	●	1
	100	Ø 19,6	120	FMLA/120/100100	5.700	●	1
	100	Ø 19,6	180	FMLA/180/100100	5.700	●	1
	100	Ø 19,6	240	FMLA/240/100100	5.700	●	1
	100	Ø 19,6	320	FMLA/320/100100	5.700	●	1
	100	Ø 19,6	400	FMLA/400/100100	5.700	●	1



• Never use too much pressure: the flaps will become distorted and the cutting capacity will decrease.

• In case of slow material removal, it is better to choose a coarser grit type than to increase the pressure or the circumferential speed.

➤ Pleated cloth wheels

PLEATED CLOTH WHEELS

Applications: Grinding down inside weld seams

To be mounted on:

- Angle grinders
- Straight grinders
- Stationary machines

diam.	width	spindle diam.	grit	code	max RPM	stock	
Ø 165	12	Ø 25	60	VA/60/16525	5.800	●	1
	12	Ø 25	80	VA/80/16525	5.800	●	1
	12	Ø 25	120	VA/120/16525	5.800	●	1
	12	Ø 25	220	VA/220/16525	5.800	●	1
Ø 200	15	Ø 25	60	VA/60/20025	5.800	●	1
	15	Ø 25	80	VA/80/20025	5.800	●	1
	15	Ø 25	120	VA/120/20025	5.800	●	1
	15	Ø 25	220	VA/220/20025	5.800	●	1

CLOTH ABRASIVES



➤ Cloth flap wheels - M14

WITH ZIRCONIUM FLAPS

Applications: Remove weld seams on round surfaces

To be mounted on: Angle grinders

diam.	width	attach-ment	grit	code	max RPM	stock	
Ø 115	20	M14	40	LM/40/11520/Z	13.300	●	5
	20	M14	60	LM/60/11520/Z	13.300	●	5
	20	M14	80	LM/80/11520/Z	13.300	●	5
	20	M14	120	LM/120/11520/Z	13.300	●	5
Ø 125	20	M14	40	LM/40/12520/Z	12.200	●	5
	20	M14	60	LM/60/12520/Z	12.200	●	5
	20	M14	80	LM/80/12520/Z	12.200	●	5
	20	M14	120	LM/120/12520/Z	12.200	●	5

CLOTH ABRASIVES



● = available from stock

● = available in 5 working days

● = on request

> Tex flap wheels

TEX

WITH CENTRE HOLE



- Properties :**
- Fine finish
 - Flexible and comfortable operation
- Applications:**
- Satinising
- To be mounted on:**
- Stationary machines
 - Wheels Ø150 mm: heavy industrial machines with flexible shafts

diam.	width	spindle diam.	grit	code	max RPM	stock	
Ø 150	50	Ø 54	SUF	TA/SUF/15050	3.600	●	10
	50	Ø 54	SF	TA/SF/15050	3.600	●	10
	50	Ø 54	AVF	TA/AVF/15050	3.600	●	10
	50	Ø 54	AF	TA/AF/15050	3.600	●	10
	50	Ø 54	AC	TA/AC/15050	3.600	●	10
Ø 200	30	Ø 76	SUF	TA/SUF/20030	3.000	●	1
	30	Ø 76	SF	TA/SF/20030	3.000	●	1
	30	Ø 76	AVF	TA/AVF/20030	3.000	●	1
	30	Ø 76	AF	TA/AF/20030	3.000	●	1
	30	Ø 76	AC	TA/AC/20030	3.000	●	1
	30	Ø 76	CP	TA/CP/20030	3.000	●	1
	50	Ø 76	SUF	TA/SUF/20050	3.000	●	1
	50	Ø 76	SF	TA/SF/20050	3.000	●	1
	50	Ø 76	AVF	TA/AVF/20050	3.000	●	1
	50	Ø 76	AF	TA/AF/20050	3.000	●	1
Ø 250	60	Ø 115	SUF	TA/SUF/25060	2.800	●	1
	60	Ø 115	SF	TA/SF/25060	2.800	●	1
	60	Ø 115	AVF	TA/AVF/25060	2.800	●	1
	60	Ø 115	AF	TA/AF/25060	2.800	●	1
	60	Ø 115	AC	TA/AC/25060	2.800	●	1
	60	Ø 115	CP	TA/CP/25060	2.800	●	1



Reducing flanges: see p. 482



For other references: contact CIBO.

Tex flap wheels

FINIMASTER BASIC AND OTHER SATINISING MACHINES

Applications:

- Cleaning
- Satinising
- Applying a decorative finish to, amongst others, stainless steel, aluminium and brass
- Removal of rust and oxidation

To be mounted on: Finimaster Basic and other satinising machines

diam.	width	spindle diam.	grit	code	max RPM	stock	
Ø 100	100	Ø 19,6	80	FMTA/80/100100	5.700	●	1
	100	Ø 19,6	180	FMTA/180/100100	5.700	●	1
	100	Ø 19,6	280	FMTA/280/100100	5.700	●	1
	100	Ø 19,6	400	FMTA/400/100100	5.700	●	1
	100	Ø 19,6	600	FMTA/600/100100	5.700	●	1
	100	Ø 19,6	CP	FMTA/CP/100100	5.700	●	1
	50	Ø 19,6	80	FMTA/80/10050	5.700	●	2
	50	Ø 19,6	180	FMTA/180/10050	5.700	●	2
	50	Ø 19,6	280	FMTA/280/10050	5.700	●	2
	50	Ø 19,6	400	FMTA/400/10050	5.700	●	2
	50	Ø 19,6	600	FMTA/600/10050	5.700	●	2
	50	Ø 19,6	CP	FMTA/CP/10050	5.700	●	2



TEX



When tex flap wheels are used we do not recommend very high pressure because this causes heat generation and does not increase efficiency. In addition, too high pressure has a negative impact on the efficiency and lifespan and requires the use of excessive energy from both the operator and the machine.



● = available from stock

● = available in 5 working days

● = on request

Tex flap wheels

TEX



FINIMASTER PRO - M14

Applications:

- Cleaning
- Satinising
- Applying a decorative finish to, amongst others, stainless steel, aluminium and brass
- Removing rust and oxidation

To be mounted on:

- Finimaster Pro
- 50 mm wide wheels: Adjustable angle grinders

diam.	width	attach- ment	grit	code	max RPM	stock	
Ø 120	50	M14	80	FMTM/80/12050	4.200	●	1
	50	M14	180	FMTM/180/12050	4.200	●	1
	50	M14	280	FMTM/280/12050	4.200	●	1
	50	M14	400	FMTM/400/12050	4.200	●	1
	50	M14	600	FMTM/600/12050	4.200	●	1
	50	M14	CP	FMTM/CP/12050	4.200	●	1
110	50	M14	80	FMTM/80/120110	4.200	●	1
	50	M14	180	FMTM/180/120110	4.200	●	1
	50	M14	280	FMTM/280/120110	4.200	●	1
	50	M14	400	FMTM/400/120110	4.200	●	1
	50	M14	600	FMTM/600/120110	4.200	●	1
	50	M14	CP	FMTM/CP/120110	4.200	●	1



These wheels form a very strong team in combination with the Finishing Kit. Finishing a mitre has never been this easy! See p. 167.



Did you know you can easily mount 50 mm wide wheels on your adjustable angle grinder in order to very easily apply a perfect brush structure?



> CSD-wheels

FINIMASTER BASIC AND OTHER SATINISING MACHINES

- Applications:**
- Cleaning weld seams
 - Removal of lacquer, paints and epoxy layers
 - Removal of rust
 - Roughing surfaces to apply glue and coatings

To be mounted on: Finimaster Basic and other satinising machines

diam.	width	center hole	code	max RPM	stock	
Ø 100	100	Ø 19,6	FMCS100100	5.700	●	1

CSD



WITH CENTRE HOLE

- Applications:**
- Cleaning weld seams
 - Removing lacquer, paints and epoxy layers
 - Removing rust
 - Roughing surfaces to apply glue and coatings

To be mounted on:

- Finit-Easy
- Straight grinders

diam.	width	center hole	code	max RPM	stock	
Ø 75	13	Ø 6	CSA7513	10.000	●	10
Ø 100	13	Ø 6	CSA10013	7.500	●	10
Ø 150	13	Ø 10	CSA15013	4.500	●	10
Ø 200	13	Ø 13	CSA20013	3.200	●	10

CSD



● = available from stock

● = available in 5 working days

● = on request

> Combination flap wheels

COMBI



CLOTH/TEX

Applications:

- Removing scratches and surface damage
- Applying a line structure
- Same applications as tex-wheels, but more aggressive because of the operation of the cloth flaps
- Fine deburring with a perfect finish
- Much valued for all applications where a regular line structure is required

To be mounted on: Stationary machines

diam.	width	spindle diam.	grit	code	max RPM	stock	
Ø 200	30	Ø 76	60	CA/60/20030	2.800	●	1
	30	Ø 76	120	CA/120/20030	2.800	●	1
	30	Ø 76	240	CA/240/20030	2.800	●	1
	50	Ø 76	60	CA/60/20050	2.800	●	1
	50	Ø 76	120	CA/120/20050	2.800	●	1
	50	Ø 76	240	CA/240/20050	2.800	●	1
Ø 250	60	Ø 115	60	CA/60/25060	2.800	●	1
	60	Ø 115	120	CA/120/25060	2.800	●	1
	60	Ø 115	240	CA/240/25060	2.800	●	1

COMBI



FINIMASTER BASIC AND OTHER SATINISING MACHINES

Applications:

- Cleaning
- Satinising
- Applying a decorative finish to, amongst others, stainless steel, aluminium and brass
- Removing rust and oxidation
- Removing scratches
- Applying line structure

To be mounted on: Finimaster Basic and other satinising machines

diam.	width	spindle diam.	grit	code	max RPM	stock	
Ø 100	100	Ø 19,6	80	FMCA/80/100100	5.700	●	1
	100	Ø 19,6	180	FMCA/180/100100	5.700	●	1
	50	Ø 19,6	80	FMCA/80/10050	5.700	●	2
	50	Ø 19,6	180	FMCA/180/10050	5.700	●	2



If the machine allows it, you should work at low speed and low working pressure. A higher speed does allow a higher pressure, but has a negative impact on the lifespan and the stock removal capacity of the grinding wheels.

> Combination flap wheels

FINIMASTER PRO - M14

- Applications:**
- Cleaning
 - Satinising
 - Applying a decorative finish to, amongst others, stainless steel, aluminium and brass
 - Removing rust and oxidation
 - Removing scratches
 - Applying line structure
- To be mounted on:**
- Finimaster Pro
 - 50 mm wide wheels: adjustable angle grinder

diam.	width	attach- ment	grit	code	max RPM	stock	
Ø 120	50	M14	80	FMCM/80/12050	4.200	●	1
	50	M14	180	FMCM/180/12050	4.200	●	1
	110	M14	80	FMCM/80/120110	4.200	●	1
	110	M14	180	FMCM/180/120110	4.200	●	1

COMBI



Did you know you can easily mount 50 mm wide wheels on your adjustable angle grinder in order to very easily apply a perfect brush structure?



● = available from stock

● = available in 5 working days

● = on request

Finishing wheels

CONVOLUTE

CONVOLUTE WHEELS SA



Applications: Deburring, cleaning, brushing, structuring, finishing, removing scratches, satinising, improving surface roughness and removing oxidation, rust and scale

To be mounted on:

- Finit-Easy
- Stationary machines
- Wheels Ø150 mm: heavy industrial machines with flexible shafts

diam.	width	spindle diam.	density	code	advised RPM	max RPM	stock	
Ø 150	6	Ø 25,4	SA1	SA1T31	4.500	6.000	●	6
	6	Ø 25,4	SA2	SA2T31	4.500	6.000	●	6
	6	Ø 25,4	SA3	SA3T31	4.500	6.000	●	6
Ø 150	25	Ø 25,4	SA1	SA1T33	4.500	6.000	●	3
	25	Ø 25,4	SA2	SA2T33	4.500	6.000	●	3
	25	Ø 25,4	SA3	SA3T33	4.500	6.000	●	3
	25	Ø 25,4	SA4C	SA4CT33	3.000	6.000	●	3
	25	Ø 25,4	SA4M	SA4MT33	3.000	6.000	●	3
Ø 150	50	Ø 25,4	SA1	SA1T34	4.500	6.000	●	2
	50	Ø 25,4	SA2	SA2T34	4.500	6.000	●	2
	50	Ø 25,4	SA3	SA3T34	4.500	6.000	●	2
	50	Ø 25,4	SA4C	SA4CT34	3.000	6.000	●	2
	50	Ø 25,4	SA4M	SA4MT34	3.000	6.000	●	2
Ø 200	12	Ø 76	SA1	SA1T40	3.450	4.500	●	2
	12	Ø 76	SA2	SA2T40	3.450	4.500	●	2
	12	Ø 76	SA3	SA3T40	3.450	4.500	●	2
	12	Ø 76	SA4C	SA4CT40	2.500	4.500	●	2
	12	Ø 76	SA4M	SA4MT40	2.500	4.500	●	2
Ø 200	25	Ø 76	SA1	SA1T41	3.450	4.500	●	3
	25	Ø 76	SA2	SA2T41	3.450	4.500	●	3
	25	Ø 76	SA3	SA3T41	3.450	4.500	●	3
	25	Ø 76	SA4C	SA4CT41	2.500	4.500	●	3
	25	Ø 76	SA4M	SA4MT41	2.500	4.500	●	3



For optimal efficiency, the pores of the finishing wheels have to be opened. This can be done easily with our abrasive file **SV19030** in combination with the abrasive sheets **706GR/24/V006**. See p. 437.



CONVOLUTE WHEELS SA

diam.	width	spindle diam.	density	code	advised RPM	max RPM	stock	
Ø 200	50	Ø 76	SA1	SA1T42	3.450	4.500	●	2
	50	Ø 76	SA2	SA2T42	3.450	4.500	●	2
	50	Ø 76	SA3	SA3T42	3.450	4.500	●	2
	50	Ø 76	SA4C	SA4CT42	2.500	4.500	●	2
	50	Ø 76	SA4M	SA4MT42	2.500	4.500	●	2
Ø 300	50	Ø 127	SA1	SA1T50	2.500	3.000	●	1
	50	Ø 127	SA2	SA2T50	2.500	3.000	●	1



ADVICE CONVOLUTE

	+			-
shape firmness	most unalterable			least unalterable
	SA1	SA2	SA3	SA4
can be profiled	difficult			easy
	SA1	SA2	SA3	SA4
density	hard			soft
	SA1	SA2	SA3	SA4
material removal	most aggressive			least aggressive
	SA1	SA2	SA3	SA4
finish	finer finish			coarser finish
	SA3	SA2	SA1	SA4



● = available from stock

● = available in 5 working days

● = on request

> Finishing wheels

UNITIZED

UNITIZED WHEELS SA – FOR FINIT-EASY

Applications: Grinding down and/or finishing TIG weld seams

To be mounted on: Finit-Easy



diam.	width	center hole	density	code	advised RPM	max RPM	stock	
Ø 150	3	Ø 25,4	SA7	SA7T30	3.000	6.000	●	6
	3	Ø 25,4	SA8	SA8T30	3.000	6.000	●	6
	3	Ø 25,4	SA10	SA10T30	3.000	6.000	●	6
	6	Ø 25,4	SA5	SA5T31	3.000	6.000	●	6
	6	Ø 25,4	SA6	SA6T31	3.000	6.000	●	6
	6	Ø 25,4	SA7	SA7T31	3.000	6.000	●	6
	6	Ø 25,4	SA8	SA8T31	3.000	6.000	●	6
	6	Ø 25,4	SA10	SA10T31	3.000	6.000	●	6



Unitized & Finit-Easy: a perfect combination!

The 3 mm and 6 mm wide Ø150 mm unitized wheels have been specially developed for use in combination with Cibo's Finit-Easy. Through the combination of this ingenious extension arm and the unitized wheels, you can grind down the weld seams in the inside corners in no time, even in the most inaccessible places.

Finit-Easy: see p. 429



> Finishing wheels

UNITIZED

COMPRESSED WHEELS SA (UNITIZED)



Applications: Deburring, cleaning, brushing, structuring, finishing, removing scratches, satinising, improving surface roughness and removing oxidation, rust and scale

To be mounted on: • Straight grinders
• Wheels Ø150 mm: heavy industrial machines with flexible shafts

diam.	width	spindle diam.	density	code	advised RPM	max RPM	stock	
Ø 75	3	Ø 6	SA7	SA7T20	6.000	12.000	●	10
	3	Ø 6	SA8	SA8T20	6.000	12.000	●	10
	3	Ø 6	SA10	SA10T20	6.000	12.000	●	10
	6	Ø 6	SA5	SA5T21	6.000	12.000	●	10
	6	Ø 6	SA6	SA6T21	6.000	12.000	●	10
	6	Ø 6	SA7	SA7T21	6.000	12.000	●	10
	6	Ø 6	SA8	SA8T21	6.000	12.000	●	10
	6	Ø 6	SA10	SA10T21	6.000	12.000	●	10
Ø 100	3	Ø 6	SA7	SA7T22	4.500	9.000	●	10
	3	Ø 6	SA8	SA8T22	4.500	9.000	●	10
	3	Ø 6	SA10	SA10T22	4.500	9.000	●	10
	6	Ø 6	SA5	SA5T23	4.500	9.000	●	10
	6	Ø 6	SA6	SA6T23	4.500	9.000	●	10
	6	Ø 6	SA7	SA7T23	4.500	9.000	●	10
	6	Ø 6	SA8	SA8T23	4.500	9.000	●	10
	6	Ø 6	SA10	SA10T23	4.500	9.000	●	10
Ø 150	12	Ø 25,4	SA5	SA5T32	3.000	6.000	●	3
	12	Ø 25,4	SA6	SA6T32	3.000	6.000	●	3
	12	Ø 25,4	SA7	SA7T32	3.000	6.000	●	3
	12	Ø 25,4	SA8	SA8T32	3.000	6.000	●	3
	25	Ø 25,4	SA5	SA5T33	3.000	6.000	●	3
	25	Ø 25,4	SA6	SA6T33	3.000	6.000	●	3
	25	Ø 25,4	SA7	SA7T33	3.000	6.000	●	3
	25	Ø 25,4	SA8	SA8T33	3.000	6.000	●	3





COMPRESSED WHEELS SA (UNITIZED)

diam.	width	spindle diam.	density	code	advised RPM	max RPM	stock	
Ø 200	12	Ø 76	SA5	SA5T40	2.250	4.500	●	2
	12	Ø 76	SA6	SA6T40	2.250	4.500	●	2
	12	Ø 76	SA7	SA7T40	2.250	4.500	●	2
	12	Ø 76	SA8	SA8T40	2.250	4.500	●	2
	25	Ø 76	SA5	SA5T41	2.250	4.500	●	2
	25	Ø 76	SA6	SA6T41	2.250	4.500	●	2
	25	Ø 76	SA7	SA7T41	2.250	4.500	●	2
	25	Ø 76	SA8	SA8T41	2.250	4.500	●	2



For optimal efficiency, the pores of the finishing wheels have to be opened. This can be done easily with our abrasive file **SV19030** in combination with the abrasive sheets **706GR/24/V006**. See p. 437.



For other dimensions or densities: contact CIBO.

ADVICE ON UNITIZED WHEELS

	+			-	
density	hardest			softest	
	SA10	SA8	SA7	SA6	SA5
material removal	most aggressive			least aggressive	
	SA10	SA8	SA7	SA6	SA5
finish	fine			very fine	
	SA10	SA8	SA7	SA6	SA5

● = available from stock

● = available in 5 working days

● = on request

> Spindle mounted wheels

diameter of 10 to 30 mm

A/O

CLOTH ABRASIVES

CLOTH FLAP WHEELS



Properties :

- Limited stock removal
- Elastic grinding contact
- Line structure finish

To be mounted on:

- Portable straight grinders
- Drive motors with flexible shaft

diam.	width	spindle diam.	grit	code	max RPM	stock	
Ø 10	10	Ø 3	80	LS/80/10103	30.000	●	25
	10	Ø 3	120	LS/120/10103	30.000	●	25
	10	Ø 3	180	LS/180/10103	30.000	●	25
	10	Ø 3	320	LS/320/10103	30.000	●	25
Ø 20	10	Ø 3	60	LS/60/20103	25.000	●	10
	10	Ø 3	80	LS/80/20103	25.000	●	10
	10	Ø 3	120	LS/120/20103	25.000	●	10
	10	Ø 3	180	LS/180/20103	25.000	●	10
	10	Ø 3	320	LS/320/20103	25.000	●	10
	10	Ø 6	80	LS/80/20106	25.000	●	10
	10	Ø 6	120	LS/120/20106	25.000	●	10
	10	Ø 6	150	LS/150/20106	25.000	●	10
Ø 30	5	Ø 6	120	LS/120/30056	22.900	●	10
	5	Ø 6	180	LS/180/30056	22.900	●	10
	5	Ø 6	220	LS/220/30056	22.900	●	10
	5	Ø 6	320	LS/320/30056	22.900	●	10
	10	Ø 3	40	LS/40/30103	22.900	●	10
	10	Ø 3	60	LS/60/30103	22.900	●	10
	10	Ø 3	120	LS/120/30103	22.900	●	10
	10	Ø 3	150	LS/150/30103	22.900	●	10
	10	Ø 3	320	LS/320/30103	22.900	●	10
	10	Ø 6	40	LS/40/30106	22.900	●	10
	10	Ø 6	60	LS/60/30106	22.900	●	10
	10	Ø 6	80	LS/80/30106	22.900	●	10
10	Ø 6	120	LS/120/30106	22.900	●	10	
10	Ø 6	150	LS/150/30106	22.900	●	10	





diameter of 30 to 40 mm

CLOTH FLAP WHEELS

diam.	width	spindle diam.	grit	code	max RPM	stock	
Ø 30	10	Ø 6	180	LS/180/30106	22.900	●	10
	10	Ø 6	240	LS/240/30106	22.900	●	10
	10	Ø 6	320	LS/320/30106	22.900	●	10
	15	Ø 6	80	LS/80/30156	22.900	●	10
Ø 40	10	Ø 6	320	LS/320/40106	17.100	●	10
	15	Ø 6	40	LS/40/40156	17.100	●	10
	15	Ø 6	60	LS/60/40156	17.100	●	10
	15	Ø 6	80	LS/80/40156	17.100	●	10
	15	Ø 6	120	LS/120/40156	17.100	●	10
	15	Ø 6	180	LS/180/40156	17.100	●	10
	15	Ø 6	240	LS/240/40156	17.100	●	10
	15	Ø 6	320	LS/320/40156	17.100	●	10
	20	Ø 6	60	LS/60/40206	17.100	●	10
	20	Ø 6	80	LS/80/40206	17.100	●	10
20	Ø 6	320	LS/320/40206	17.100	●	10	

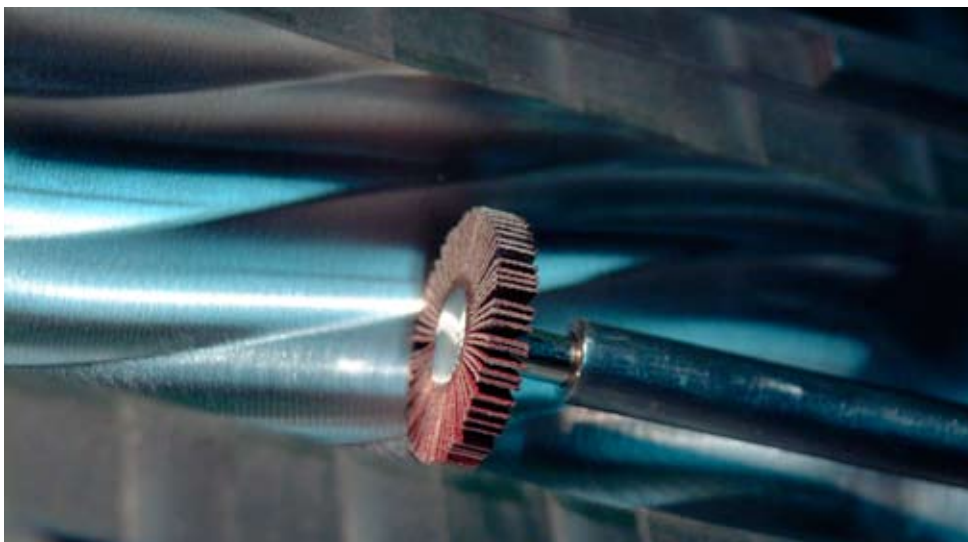

● = available from stock

● = available in 5 working days

● = on request



diameter of 50 to 60 mm

CLOTH FLAP WHEELS



diam.	width	spindle diam.	grit	code	max RPM	stock	
Ø 50	10	Ø 6	60	LS/60/50106	13.700	●	10
	10	Ø 6	80	LS/80/50106	13.700	●	10
	10	Ø 6	120	LS/120/50106	13.700	●	10
	10	Ø 6	240	LS/240/50106	13.700	●	10
	20	Ø 6	40	LS/40/50206	13.700	●	10
	20	Ø 6	60	LS/60/50206	13.700	●	10
	20	Ø 6	80	LS/80/50206	13.700	●	10
	20	Ø 6	120	LS/120/50206	13.700	●	10
	20	Ø 6	180	LS/180/50206	13.700	●	10
	20	Ø 6	240	LS/240/50206	13.700	●	10
	20	Ø 6	320	LS/320/50206	13.700	●	10
	Ø 60	20	Ø 6	60	LS/60/60206	11.400	●
20		Ø 6	80	LS/80/60206	11.400	●	10
20		Ø 6	120	LS/120/60206	11.400	●	10
20		Ø 6	240	LS/240/60206	11.400	●	10
30		Ø 6	40	LS/40/60306	11.400	●	10
30		Ø 6	60	LS/60/60306	11.400	●	10
30		Ø 6	80	LS/80/60306	11.400	●	10
30		Ø 6	120	LS/120/60306	11.400	●	10
30		Ø 6	180	LS/180/60306	11.400	●	10
30		Ø 6	240	LS/240/60306	11.400	●	10
30		Ø 6	320	LS/320/60306	11.400	●	10
50		Ø 6	60	LS/60/60506	11.400	●	10
50		Ø 6	80	LS/80/60506	11.400	●	10
50		Ø 6	240	LS/240/60506	11.400	●	10
50		Ø 6	320	LS/320/60506	11.400	●	10
50	Ø 6	400	LS/400/60506	11.400	●	10	





diameter 80 mm

CLOTH FLAP WHEELS

diam.	width	spindle diam.	grit	code	max RPM	stock	
Ø 80	20	Ø 6	60	LS/60/80206	8.500	●	10
	30	Ø 6	40	LS/40/80306	8.500	●	10
	30	Ø 6	60	LS/60/80306	8.500	●	10
	30	Ø 6	80	LS/80/80306	8.500	●	10
	30	Ø 6	120	LS/120/80306	8.500	●	10
	30	Ø 6	180	LS/180/80306	8.500	●	10
	30	Ø 6	220	LS/220/80306	8.500	●	10
	30	Ø 6	320	LS/320/80306	8.500	●	10
	50	Ø 6	40	LS/40/80506	8.500	●	10
	50	Ø 6	60	LS/60/80506	8.500	●	10
	50	Ø 6	80	LS/80/80506	8.500	●	10
	50	Ø 6	120	LS/120/80506	8.500	●	10
	50	Ø 6	180	LS/180/80506	8.500	●	10
	50	Ø 6	240	LS/240/80506	8.500	●	10
	50	Ø 6	320	LS/320/80506	8.500	●	10

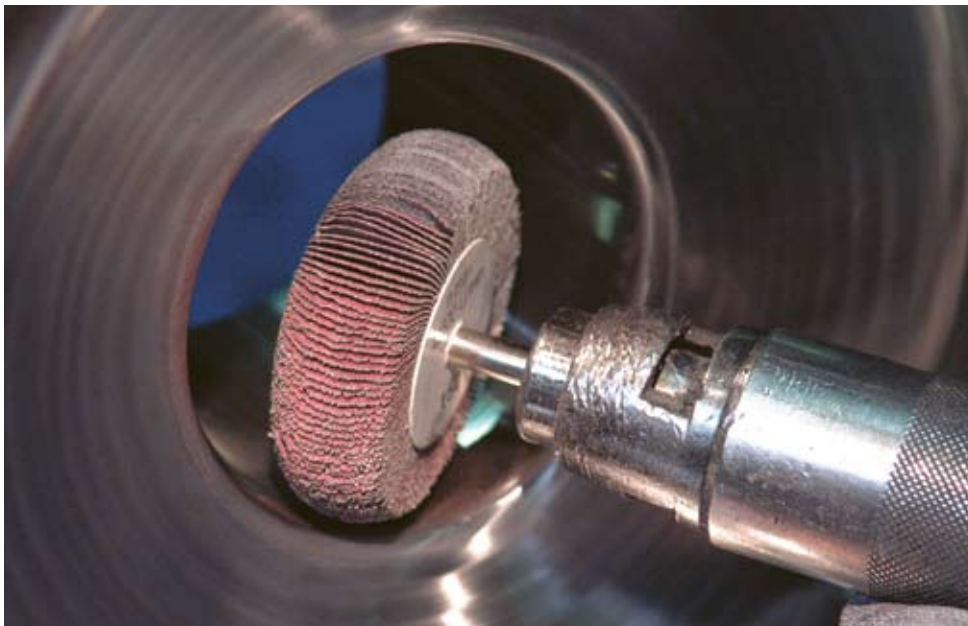

● = available from stock

● = available in 5 working days

● = on request

Spindle mounted wheels

TEX



TEX FLAP WHEELS

Properties :

- Fine finish
- Brush structure
- Soft grinding contact
- Flexible and comfortable operation

Applications:

- Brushing stainless steel, aluminium and brass
- Cleaning surfaces
- Removing oxidation
- Removing wood pulp
- Roughing surfaces
- Grinding lacquer, varnish, polyester, etc. primer and interlayer.

To be mounted on:

- Portable straight grinders
- Drive motors with flexible shaft

diam.	width	spindle diam.	grit	code	max RPM	stock	
Ø 30	20	Ø 6	F	TS/F/30206	18.500	●	10
	20	Ø 6	VF	TS/VF/30206	18.500	●	10
Ø 50	25	Ø 6	F	TS/F/50256	13.500	●	10
	25	Ø 6	VF	TS/VF/50256	13.500	●	10
	25	Ø 6	CP	TS/CP/50256	13.500	●	10
Ø 60	30	Ø 6	M	TS/M/60306	11.500	●	10
	30	Ø 6	F	TS/F/60306	11.500	●	10
	30	Ø 6	VF	TS/VF/60306	11.500	●	10
	30	Ø 6	CP	TS/CP/60306	11.500	●	10
Ø 80	50	Ø 6	M	TS/M/80506	8.500	●	10
	50	Ø 6	F	TS/F/80506	8.500	●	10
	50	Ø 6	VF	TS/VF/80506	8.500	●	10
	50	Ø 6	CP	TS/CP/80506	8.500	●	10
Ø 100	50	Ø 6	M	TS/M/100506	6.400	●	6
	50	Ø 6	F	TS/F/100506	6.400	●	6
	50	Ø 6	VF	TS/VF/100506	6.400	●	6
	50	Ø 6	CP	TS/CP/100506	6.400	●	6



For other dimensions or densities: contact CIBO.

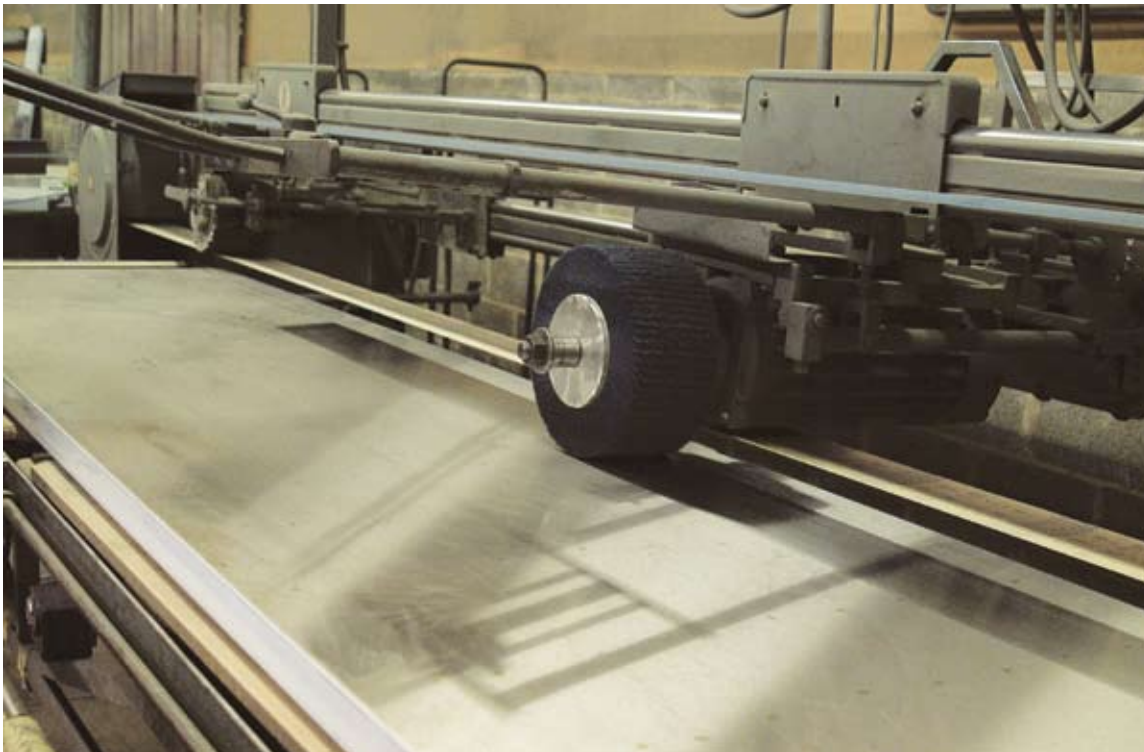

● = available from stock

● = available in 5 working days

● = on request

Quick-Lock wheels

TEX



TEX FLAP WHEELS WITH CIBO QUICK-LOCK

Properties :

- Fine finish
- Brush structure
- Soft grinding contact
- Flexible and comfortable operation

Applications:

- Brushing stainless steel, aluminium and brass
- Cleaning surfaces
- Removing oxidation
- Removing wood pulp
- Roughing surfaces
- Grinding lacquer, varnish, polyester, etc. off primer and interlayer.

To be mounted on: Quick-Lock support on a machine with 6 mm spindle attachment

diam.	width	grit	code	max RPM	code support	stock	
Ø 50	25	F	TQ/F/5025	13.500	MHS26	●	10
	25	VF	TQ/VF/5025	13.500		●	10
	25	CP	TQ/CP/5025	13.500		●	10
Ø 60	30	F	TQ/F/6030	11.500		●	10
	30	VF	TQ/VF/6030	11.500		●	10
Ø 80	50	M	TQ/M/8050	8.500		●	10
	50	F	TQ/F/8050	8.500		●	10
	50	VF	TQ/VF/8050	8.500		●	10
	50	CP	TQ/CP/8050	8.500		●	10



Supports: see also Accessories p. 481



Quick-Lock

No more messing about with 2 spanners each time you want to replace the grinding wheel.

Cibo is launching its new Quick-Lock system onto the market. You have to attach the support to your machine only once and then you can replace your grinding wheels in no time at all. The support can be mounted on all machines with a 6 mm spindle attachment. This handy system will save you a lot of time and trouble!

Spindle mounted wheels

COMBINED SPINDLE MOUNTED FLAP WHEELS: CLOTH/TEX

COMBI

- Properties :**
- Light stock removal
 - Soft grinding contact
 - Finishing line structure
 - Material removal and beautiful finish in 1 operation.
- Applications:**
- Finishing stainless steel in kitchens, amongst others, cooker hoods and sinks
 - Working and finishing stainless steel, aluminium, brass, etc.
 - Same applications as tex spindle mounted grinding wheels, but more aggressive because of the cloth flaps
 - Fine deburring, perfect finish
 - Valued for all applications where a regular, fine line structure is required
- To be mounted on:**
- Portable straight grinders
 - Drive motor with flexible shaft



diam.	width	spindle diam.	grit	code	max RPM	stock	
Ø 30	20	Ø 6	100	CS/100/30206	18.500	●	10
	20	Ø 6	150	CS/150/30206	18.500	●	10
	20	Ø 6	240	CS/240/30206	18.500	●	10
Ø 50	25	Ø 6	100	CS/100/50256	13.500	●	10
	25	Ø 6	150	CS/150/50256	13.500	●	10
	25	Ø 6	240	CS/240/50256	13.500	●	10
Ø 60	30	Ø 6	100	CS/100/60306	11.500	●	10
	30	Ø 6	150	CS/150/60306	11.500	●	10
	30	Ø 6	240	CS/240/60306	11.500	●	10
Ø 80	50	Ø 6	60	CS/60/80506	8.500	●	10
	50	Ø 6	100	CS/100/80506	8.500	●	10
	50	Ø 6	150	CS/150/80506	8.500	●	10
	50	Ø 6	240	CS/240/80506	8.500	●	10
Ø 100	50	Ø 6	60	CS/60/100506	6.400	●	6
	50	Ø 6	100	CS/100/100506	6.400	●	6
	50	Ø 6	150	CS/150/100506	6.400	●	6
	50	Ø 6	240	CS/240/100506	6.400	●	6



Never exceed the maximum permitted speed!



TIP! Lower speed: increases your work comfort, extends the lifespan of the wheel and improves your finish.

● = available from stock

● = available in 5 working days

● = on request



Quick-Lock wheels

COMBINATION FLAP WHEELS WITH CIBO QUICK-LOCK

Properties :

- Light stock removal
- Soft grinding contact
- Finishing line structure
- Material removal and beautiful finish in 1 operation.

Applications:

- Finishing stainless steel in kitchens, amongst others, cooker hoods and sinks
- Working and finishing stainless steel, aluminium, brass, etc.
- Same applications as tex spindle mounted grinding wheels, but more aggressive because of the cloth flaps
- Fine deburring, perfect finish
- Valued for all applications where a regular, fine line structure is required

To be mounted on: Quick-Lock support on a machine with 6 mm spindle attachment

diam.	width	grit	code	max RPM	code support	stock	
Ø 50	25	100	CQ/100/5025	13.500	MHS26	●	10
	25	150	CQ/150/5025	13.500		●	10
	25	240	CQ/240/5025	13.500		●	10
Ø 60	30	100	CQ/100/6030	11.500		●	10
	30	150	CQ/150/6030	11.500		●	10
	30	240	CQ/240/6030	11.500		●	10
Ø 80	50	60	CQ/60/8050	8.500		●	10
	50	100	CQ/100/8050	8.500		●	10
	50	150	CQ/150/8050	8.500		●	10
	50	240	CQ/240/8050	8.500		●	10





Supports: see also Accessories p. 481

COMBI



ADVICE ON USER SPEEDS (RPM)

			
		Stainless steel	Alu.-Non-ferrous metal Brass-Copper
Tex & Combi	Ø 30	4,900 – 5,700	4,500 – 5,100
	Ø 50	4,500 – 5,200	4,100 – 4,700
	Ø 60	3,200 – 3,700	2,900 – 3,300
	Ø 80	3,900 – 5,000	3,500 – 4,500
	Ø 100	3,000 – 4,000	2,700 – 3,600

● = available from stock

● = available in 5 working days

● = on request

➤ Spindle mounted wheels

CSD



SPINDLE-MOUNTED CSD-WHEELS

- Applications:**
- Cleaning weld seams
 - Removing lacquer, paint and epoxy layers
 - Removing rust
 - Roughing surface prior to applying glue and coatings
- To be fixed to:**
- Straight grinders
 - Drive motors with flexible shaft

diam.	width	spindle diam.	code	max RPM	stock	
Ø 50	13	Ø 6	CSS5013	16.000	●	5
	25	Ø 6	CSS5025	16.000	●	5
Ø 75	13	Ø 6	CSS7513	10.000	●	5
	25	Ø 6	CSS7525	10.000	●	5
Ø 100	13	Ø 6	CSS10013	7.500	●	5
	25	Ø 6	CSS10025	7.500	●	5
Ø 150	13	Ø 6	CSS15013	4.500	●	5
	25	Ø 6	CSS15025	4.500	●	5



Spindle mounted wheels

SPINDLE-MOUNTED UNITIZED WHEELS

Applications: Deburring, cleaning, brushing, structuring, finishing, removing scratches, satinising, improving surface roughness and removing oxidation, rust and scale, removing weld discolourations

To be mounted on: • Straight grinders
• Drive motors with flexible shaft

diam.	width	spindle diam.	den- sity	code	max RPM	advised RPM	stock	
Ø 50	3	Ø 6	SA7	SAUS/7/50036	15.000	7.500	●	5
	6	Ø 6	SA5	SAUS/5/50066	15.000	7.500	●	5
	6	Ø 6	SA6	SAUS/6/50066	15.000	7.500	●	5
	6	Ø 6	SA7	SAUS/7/50066	15.000	7.500	●	5
	13	Ø 6	SA5	SAUS/5/50136	15.000	7.500	●	5
	13	Ø 6	SA6	SAUS/6/50136	15.000	7.500	●	5
	13	Ø 6	SA7	SAUS/7/50136	15.000	7.500	●	5
	25	Ø 6	SA5	SAUS/5/50256	15.000	7.500	●	5
	25	Ø 6	SA6	SAUS/6/50256	15.000	7.500	●	5
	25	Ø 6	SA7	SAUS/7/50256	15.000	7.500	●	5
Ø 75	3	Ø 6	SA7	SAUS/7/75036	15.000	7.500	●	5
	6	Ø 6	SA5	SAUS/5/75066	15.000	7.500	●	5
	6	Ø 6	SA6	SAUS/6/75066	15.000	7.500	●	5
	6	Ø 6	SA7	SAUS/7/75066	15.000	7.500	●	5
	13	Ø 6	SA5	SAUS/5/75136	15.000	7.500	●	5
	13	Ø 6	SA6	SAUS/6/75136	15.000	7.500	●	5
	13	Ø 6	SA7	SAUS/7/75136	15.000	7.500	●	5
	25	Ø 6	SA5	SAUS/5/75256	15.000	7.500	●	5
	25	Ø 6	SA6	SAUS/6/75256	15.000	7.500	●	5
	25	Ø 6	SA7	SAUS/7/75256	15.000	7.500	●	5
Ø 100	3	Ø 6	SA7	SAUS/7/100036	15.000	6.000	●	5
	6	Ø 6	SA5	SAUS/5/100066	12.000	6.000	●	5
	6	Ø 6	SA6	SAUS/6/100066	12.000	6.000	●	5
	6	Ø 6	SA7	SAUS/7/100066	12.000	6.000	●	5
	13	Ø 6	SA5	SAUS/5/100136	12.000	6.000	●	5
	13	Ø 6	SA6	SAUS/6/100136	12.000	6.000	●	5
	13	Ø 6	SA7	SAUS/7/100136	12.000	6.000	●	5
	25	Ø 6	SA5	SAUS/5/100256	12.000	6.000	●	5
	25	Ø 6	SA6	SAUS/6/100256	12.000	6.000	●	5
	25	Ø 6	SA7	SAUS/7/100256	12.000	6.000	●	5

● = available from stock

● = available in 5 working days

● = on request

UNITIZED



SA5 = Soft - SA6, SA7 = Medium

The unitized spindle-mounted wheels are ideal for polishing and cleaning inside diameters and surfaces that are difficult to reach.



MOUNTED POINTS

- **Shapes** 352
- **Spindle mounted points** 356
 - White corundum 356
 - Pink corundum 356
 - Black corundum 357
 - Grey / Silicon carbide 357
- **Mounted points** 358
 - Reinforced cotton or unitized? 358
 - Reinforced cotton 359
 - Unitized 361



MOUNTED POINTS



▶ SHAPES

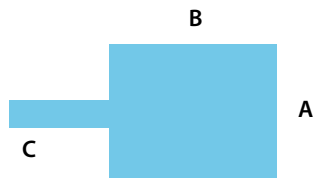















A = diameter

B = width

C = spindle

Shape	A (Ø in mm)	B (in mm)	C (Ø in mm)	
A3	22	70	6	
A4	30	30	6	
A5	20	28	6	
A11	21	45	6	
A12	18	30	6	
A12S	12	12	6	
A15	6	25	6	
A20S	20	20	6	
A21	25	25	6	
A25	25	25	6	
A26	16	16	6	
B42	13	20	3	
B52	10	20	3	
B90	13	13	3	
B121	13	13	3	
B122	10	10	3	
W153	5	10	3	

Shape	A (Ø in mm)	B (in mm)	C (Ø in mm)	
W160	6	6	3	
W163	6	13	3	
W175	10	10	3	
W176	10	13	6	
W177	10	20	6	
W178	10	25	6	
W179	10	32	6	
W183	13	6	6	
W185	13	13	6	
W186	13	20	6	
W196	16	25	6	
W204	20	20	6	
W206	20	32	6	
W220	25	25	6	

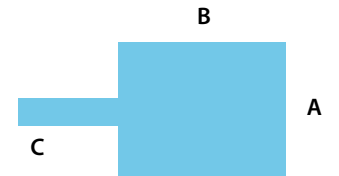

A = diameter

B = width

C = spindle

> **SHAPES**

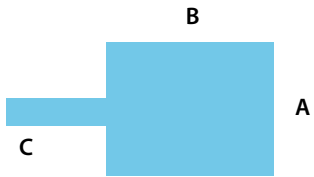

A = diameter

B = width

C = spindle

Shape	A (Ø in mm)	B (in mm)	C (Ø in mm)	
W227	32	13	6	
W229	32	25	6	
W230	32	32	6	
W236	40	13	6	
W237	40	25	6	
W4032	40	32	6	



> Spindle mounted points

WHITE CORUNDUM



WHITE CORUNDUM

Applications: High alloyed steel, HSS-tools, etc.

To be mounted on: Straight grinders

shape	diameter	height	spindle diameter	code	colour	max RPM*	stock	
A12	Ø 18	30	Ø 6	SWA12	White	39.000	●	10
W153	Ø 5	10	Ø 6	SWW153	White	97.700	●	10
W227	Ø 32	13	Ø 6	SWW227	White	29.800	●	10
W204	Ø 20	20	Ø 6	SWW204	White	42.000	●	10

PINK CORUNDUM



PINK CORUNDUM

Applications: Generally for cast iron and steel.

To be mounted on: Straight grinders

shape	diameter	height	spindle diameter	code	colour	max RPM*	stock	
W163	Ø 6	13	Ø 3	SRW163	Pink	42.000	●	10
W176	Ø 10	13	Ø 6	SRW176	Pink	88.000	●	10
W179	Ø 10	32	Ø 6	SRW179	Pink	48.000	●	10
W196	Ø 16	25	Ø 6	SRW196	Pink	35.000	●	10
W204	Ø 20	20	Ø 6	SRW204	Pink	42.000	●	10
W220	Ø 25	25	Ø 6	SRW220	Pink	30.000	●	10
W229	Ø 32	25	Ø 6	SRW229	Pink	20.000	●	10
W230	Ø 32	32	Ø 6	SRW230	Pink	16.000	●	10
W236	Ø 40	13	Ø 6	SRW236	Pink	23.000	●	10
W237	Ø 40	25	Ø 6	SRW237	Pink	19.000	●	10
W4032	Ø 40	32	Ø 6	SRW4032	Pink	15.000	●	10
A3	Ø 22	70	Ø 6	SRA3	Pink	14.000	●	10
A4	Ø 30	30	Ø 6	SRA4	Pink	26.000	●	10
A5	Ø 20	28	Ø 6	SRA5	Pink	39.000	●	10
A11	Ø 21	45	Ø 6	SRA11	Pink	17.000	●	10
A12	Ø 18	30	Ø 6	SRA12	Pink	39.000	●	10
A12S	Ø 12	12	Ø 6	SRA12S	Pink	54.000	●	10
A20S	Ø 20	20	Ø 6	SRA20S	Pink	42.000	●	10



* Max. RPM with a maximum free spindle length of 12 mm.

> Spindle mounted points

BLACK CORUNDUM (BINDING BAKELITE)

Applications: All burr operations on steel, stainless steel, weld seams, etc.

To be mounted on: Straight grinders

shape	diameter	height	spindle diameter	code	colour	max RPM*	stock	
W179	Ø 10	32	Ø 6	SZW179	Black	48.000	●	10
W206	Ø 20	32	Ø 6	SZW206	Black	24.000	●	10
W220	Ø 25	25	Ø 6	SZW220	Black	30.000	●	10
W230	Ø 32	32	Ø 6	SZW230	Black	16.000	●	10
W236	Ø 40	13	Ø 6	SZW236	Black	23.000	●	10
A3	Ø 22	70	Ø 6	SZA3	Black	14.000	●	10
A4	Ø 30	30	Ø 6	SZA4	Black	26.000	●	10
A11	Ø 21	45	Ø 6	SZA11	Black	17.000	●	10

BLACK CORUNDUM (BINDING BAKELITE)



GREY / SILICON CARBIDE

Applications: For stone, plastic and non-ferrous metals

To be mounted on: Straight grinders

shape	diameter	height	spindle diameter	code	colour	max RPM*	stock	
W179	Ø 10	32	Ø 6	SGW179	Black	48.000	●	10
W220	Ø 25	25	Ø 6	SGW220	Black	30.000	●	10
A4	Ø 30	30	Ø 6	SGA4	Black	26.000	●	10

GREY / SILICON CARBIDE

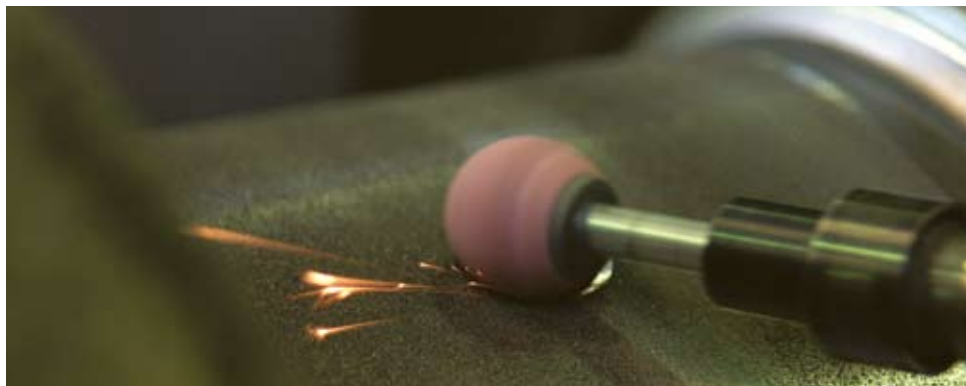

* Max. RPM with a maximum free spindle length of 12 mm.



● = available from stock

● = available in 5 working days

● = on request

➤ WHEN SHOULD YOU CHOOSE REINFORCED COTTON OR UNITIZED?



REINFORCED COTTON

2 different bonds can be distinguished in the reinforced cotton:

GFA

Soft latex bond:

- minor deburring and finishing in a single operation
- extremely forgiving

MTA

Resin bond, harder than GFA

- longer lifespan and angle resistance
- relative quick stock removal
- simultaneously provides an even shiny grinding image



UNITIZED

Compressed, impregnated fibres, even softer than GFA:

- finishing spindles: high finish
- limited stock removal capacity
- adapt easily to the workpiece
- even more forgiving than GFA



Spindle length & max. RPM

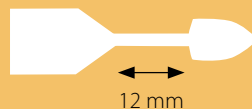

The maximum permitted speed (max. RPM) is determined by the free spindle length of the grinding point. The maximum permitted speed indicated in this chapter by the item numbers is valid for a maximum free point spindle of 12 mm.

Doubling the free spindle length reduces the maximum permitted speed by half.

➤ Mounted points

REINFORCED COTTON

- Applications:**
- Removing internal weld seams
 - Works more aggressively than compressed grinding materials
- To be mounted on:**
- Straight grinders
 - Driving motors with flexible shafts

shape	diameter	spindle diameter	grit	code	max RPM*	stock	
A12	Ø 18	Ø 6	GF A36	RCMP/A12/GFA36	38.000	●	10
A15	Ø 6	Ø 6	MT A80	RCMP/A15/MTA80	81.300	●	10
A15	Ø 6	Ø 6	GF A120	RCMP/A15/GFA120	81.300	●	10
A25	Ø 25	Ø 6	MT A24	RCMP/A25/MTA24	34.500	●	10
A25	Ø 25	Ø 6	GF A36	RCMP/A25/GFA36	34.500	●	10
A26	Ø 16	Ø 6	MT A80	RCMP/A26/MTA80	38.900	●	10
A26	Ø 16	Ø 6	GF A120	RCMP/A26/GFA120	38.900	●	10
A3	Ø 25	Ø 6	GF A36	RCMP/A3/GFA36	34.500	●	10
A5	Ø 19	Ø 6	MT A54	RCMP/A5/MTA54	38.900	●	10
B121	Ø 13	Ø 6	MT A80	RCMP/B121/MTA80	45.300	●	10
B121	Ø 13	Ø 6	GFA120	RCMP/B121/GFA120	45.300	●	10
B122	Ø 10	Ø 3	MT A80	RCMP/B122/MTA80/3	45.300	●	10
B122	Ø 10	Ø 3	GF A120	RCMP/B122/GFA120/3	45.300	●	10
B122	Ø 10	Ø 6	MT A80	RCMP/B122/MTA80	45.300	●	10
B122	Ø 10	Ø 6	GF A120	RCMP/B122/GFA120	45.300	●	10
B42	Ø 13	Ø 6	GF A120	RCMP/B42/GFA120	45.300	●	10
B42	Ø 13	Ø 6	MT A80	RCMP/B42/MTA80	45.300	●	10
B52	Ø 10	Ø 3	MT A80	RCMP/B52/MTA80/3	45.300	●	10
B52	Ø 10	Ø 3	GF A120	RCMP/B52/GFA120/3	45.300	●	10
B52	Ø 10	Ø 6	MT A54	RCMP/B52/MTA54	45.300	●	10
B52	Ø 10	Ø 6	GF A80	RCMP/B52/GFA80	45.300	●	10
B52	Ø 10	Ø 6	MT A80	RCMP/B52/MTA80	45.300	●	10
B52	Ø 10	Ø 6	GF A120	RCMP/B52/GFA120	45.300	●	10
W160	Ø 6	Ø 3	MT A80	RCMP/W160/MTA80/3	81.300	●	10
W160	Ø 6	Ø 3	GF A120	RCMP/W160/GFA120/3	81.300	●	10
W163	Ø 6	Ø 6	MT A80	RCMP/W163/MTA80	81.300	●	10
W175	Ø 10	Ø 3	MT A80	RCMP/W175/MTA80/3	45.300	●	10
W175	Ø 10	Ø 3	GF A120	RCMP/W175/GFA120/3	45.300	●	10
W175	Ø 10	Ø 6	MT A80	RCMP/W175/MTA80	45.300	●	10

REINFORCED COTTON



● = available from stock

● = available in 5 working days

● = on request





REINFORCED COTTON



shape	diameter	spindle diameter	grit	code	max RPM*	stock	
W175	Ø 10	Ø 6	GF A120	RCMP/W175/GFA120	45.300	●	10
W177	Ø 10	Ø 6	MT A54	RCMP/W177/MTA54	45.300	●	10
W177	Ø 10	Ø 6	GF A80	RCMP/W177/GFA80	45.300	●	10
W177	Ø 10	Ø 6	MT A80	RCMP/W177/MTA80	45.300	●	10
W177	Ø 10	Ø 6	GF A120	RCMP/W177/GFA120	45.300	●	10
W178	Ø 10	Ø 6	GF A120	RCMP/W178/GFA120	45.300	●	10
W183	Ø 13	Ø 6	MT A80	RCMP/W183/MTA80	45.300	●	10
W183	Ø 13	Ø 6	GF A120	RCMP/W183/GFA120	45.300	●	10
W185	Ø 13	Ø 6	GF A80	RCMP/W185/GFA80	45.300	●	10
W185	Ø 13	Ø 6	MT A80	RCMP/W185/MTA80	45.300	●	10
W185	Ø 13	Ø 6	GF A120	RCMP/W185/GFA120	45.300	●	10
W186	Ø 13	Ø 6	MT A80	RCMP/W186/MTA80	45.300	●	10
W186	Ø 13	Ø 6	GF A120	RCMP/W186/GFA120	45.300	●	10
W220	Ø 25	Ø 6	GF A36	RCMP/W220/GFA36	34.500	●	10



* Max. RPM with a maximum free spindle length of 12 mm.



> Mounted points

UNITIZED

- Applications:**
- Finishing inside weld seams and workpieces with limited accessibility
 - Removing weld discolourations
 - Removing milling lines
 - Improving surface roughness
- To be mounted on:**
- Straight grinders
 - Driving motors with flexible shafts

shape	diameter	spindle diameter	density	code	max RPM*	advised RPM	stock	
A21	Ø 25	Ø 6	SA6	SAUSA21631	34.500	34.500	●	5
A21	Ø 25	Ø 6	SA7	SAUSA21731	34.500	34.500	●	5
A21	Ø 25	Ø 6	SA8	SAUSA21821	34.500	34.500	●	5
A21	Ø 25	Ø 6	SA8	SAUSA21811	34.500	34.500	●	5
A21	Ø 25	Ø 6	SA6	SAUSA21632	34.500	34.500	●	5
A21	Ø 25	Ø 6	SA7	SAUSA21732	34.500	34.500	●	5
A25	Ø 25	Ø 6	SA8	SAUSA25821	35.600	35.600	●	5
A25	Ø 25	Ø 6	SA8	SAUSA25811	35.600	35.600	●	5
B52	Ø 10	Ø 3	SA7	SAUSB52731	45.300	45.300	●	5
B52	Ø 10	Ø 3	SA7	SAUSB52732	45.300	45.300	●	5
B90	Ø 13	Ø 3	SA7	SAUSB90731	34.500	34.500	●	5
B90	Ø 13	Ø 3	SA8	SAUSB90821	34.500	34.500	●	5
B90	Ø 13	Ø 3	SA8	SAUSB90811	34.500	34.500	●	5
B90	Ø 13	Ø 3	SA7	SAUSB90732	34.500	34.500	●	5
B121	Ø 13	Ø 3	SA7	SAUSB121731	45.300	45.300	●	5
B121	Ø 13	Ø 3	SA8	SAUSB121821	45.300	45.300	●	5
B121	Ø 13	Ø 3	SA8	SAUSB121811	45.300	45.300	●	5
W160	Ø 6	Ø 3	SA8	SAUSW160821	81.300	81.300	●	5
W163	Ø 6	Ø 3	SA8	SAUSW163821	60.000	60.000	●	5
W163	Ø 6	Ø 3	SA8	SAUSW163811	60.000	60.000	●	5
W183	Ø 13	Ø 3	SA7	SAUSW183731	51.700	51.700	●	5
W183	Ø 13	Ø 3	SA8	SAUSW183821	51.700	51.700	●	5



UNITIZED



● = available from stock

● = available in 5 working days

● = on request



UNITIZED



shape	diameter	spindle diameter	density	code	max RPM*	advised RPM	stock	
W183	Ø 13	Ø 3	SA8	SAUSW183811	51.700	51.700	●	5
W183	Ø 13	Ø 3	SA6	SAUSW183632	51.700	51.700	●	5
W183	Ø 13	Ø 3	SA7	SAUSW183732	51.700	51.700	●	5
W185	Ø 13	Ø 3	SA6	SAUSW185631	34.500	34.500	●	5
W185	Ø 13	Ø 3	SA7	SAUSW185731	34.500	34.500	●	5
W185	Ø 13	Ø 3	SA8	SAUSW185821	34.500	34.500	●	5
W185	Ø 13	Ø 3	SA8	SAUSW185811	34.500	34.500	●	5
W185	Ø 13	Ø 3	SA6	SAUSW185632	34.500	34.500	●	5
W185	Ø 13	Ø 3	SA7	SAUSW185732	34.500	34.500	●	5
W220	Ø 25	Ø 6	SA8	SAUSW220821	25.000	25.000	●	5
W220	Ø 25	Ø 6	SA8	SAUSW220811	25.000	25.000	●	5



* Max. RPM with a maximum free spindle length of 12 mm.



For other references, please contact Cibo.



Mounted felt points are discussed in the chapter on polishing materials on p. 372



POLISHING MATERIALS

● Introduction	366
● Polishing wheels	366
○ Sisal	366
○ Sewn	366
○ Cotton	366
○ Single	366
○ Sewn	367
○ Ventilated	367
○ Flannel	368
○ Sewn	368
○ Ventilated	368
● Finimaster wheels	370
○ Finimaster basic and other satinising machines	370
○ Sisal	370
○ Cotton	370
○ Felt	370
○ Finimaster pro	370
○ Cotton	370
○ Flannel	371
● Felt discs	371
○ Velcro backed	371
○ M14	371
● Felt wheels	372
● Mounted felt points	372
○ Straight	372
○ Conical	372
○ Point	373
○ Ball	373

● Compound sponges	374
● Lambswool	374
● Polishing bars	375
● Liquid polishing paste	376
● Inoxiclean (Vienna chalk)	376



POLISHING MATERIALS



INTRODUCTION

In finishing a workpiece, polishing is the last step in the grinding process. Polishing is not a clean job. The polishing pastes are greasy, and in combination with the rotating polishing wheels, they can dirty the operator of the device and the entire surrounding area. For this reason, polishing work is

often kept to a minimum. It is therefore important to sand the workpiece properly in preparation. Cibo technical abrasive products will help you prepare the job correctly, to achieve a high-grade finish more quickly and easily.



Polishing wheels

SEWN

SISAL

SEWN - SISAL IMPREGNATED



diameter	width	centre hole	type	code	stock	
Ø 150	20	25	Sisal	BSI1502025	●	1
Ø 200	20	30	Sisal	BSI2002030	●	1
Ø 250	25	30	Sisal	BSI2502530	●	1
Ø 300	25	30	Sisal	BSI3002530	●	1

SINGLE

COTTON

SINGLE



diameter	centre hole	type	code	code mounthing shaft	stock	
Ø 60	8	White cotton	PLL/W/6008	MHS6	●	0,2kg
Ø 100	8	White cotton	PLL/W/10008		●	0,2kg
Ø 125	10	White cotton	PLL/W/12510		●	0,5kg
Ø 150	10	White cotton	PLL/W/15010		●	0,5kg
Ø 200	20	White cotton	PLL/W/20020		●	1kg
Ø 250	20	White cotton	PLL/W/25020		●	1kg
Ø 300	25	White cotton	PLL/W/30025		●	1kg
Ø 350	25	White cotton	PLL/W/35025		●	1kg



Overview mounting shafts : see p. 477

➤ Polishing wheels

SEWN

diameter	width	centre hole	type	code	stock	
Ø 125	20	10	White cotton	PLG/W/1252010	●	1
Ø 150	20	10	White cotton	PLG/W/1502010	●	1
Ø 200	20	20	White cotton	PLG/W/2002020	●	1
Ø 250	20	25	White cotton	PLG/W/2502025	●	1
Ø 300	25	25	White cotton	PLG/W/3002525	●	1
Ø 350	25	25	White cotton	PLG/W/3502525	●	1

COTTON

SEWN



VENTILATED – WITH INSIDE CORE

diameter	width	centre hole	type	code	stock	
Ø 150	20	25	White cotton	PLV/W/1502025	●	1
Ø 200	20	30	White cotton	PLV/W/2002030	●	1
Ø 250	25	30	White cotton	PLV/W/2502530	●	1
Ø 300	25	30	White cotton	PLV/W/3002530	●	1

COTTON

VENTILATED



Patience is an important virtue in polishing! Check the grinding result carefully. If necessary, repeat the previous grinding step to make sure all scratches have been completely removed.

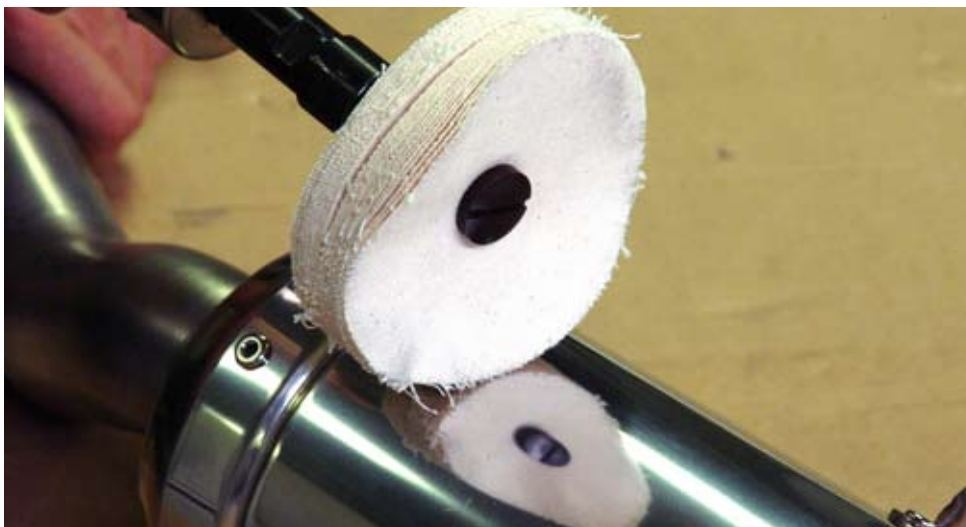

● = available from stock

● = available in 5 working days

● = on request

> Polishing wheels

SEWN

FLANNEL

SEWN



diameter	width	centre hole	type	code	stock	
Ø 125	20	10	Flannel	PLG/F/1252010	●	1
Ø 150	20	10	Flannel	PLG/F/1502010	●	1
Ø 200	20	20	Flannel	PLG/F/2002020	●	1
Ø 250	20	25	Flannel	PLG/F/2502025	●	1
Ø 300	25	25	Flannel	PLG/F/3002525	●	1
Ø 350	25	25	Flannel	PLG/F/3502525	●	1

VENTILATED

FLANNEL

VENTILATED – WITH INSIDE CORE



diameter	width	centre hole	type	code	stock	
Ø 150	20	25	Flannel	PLV/F/1502025	●	1
Ø 200	20	30	Flannel	PLV/F/2002030	●	1
Ø 250	25	30	Flannel	PLV/F/2502530	●	1
Ø 300	25	30	Flannel	PLV/F/3002530	●	1

Speed

Determining the correct speed is very important in the polishing process.

The higher the speed, the harder the contact and the higher the possible heat generation.

Cibo advises the following speeds as a guideline :

- stainless steel: 30 - 45 m/s
- Aluminium & Non-Ferrous metal: 45 - 60 m/s
- Chrome: 20 - 35 m/s



> Polishing wheels for Finimaster and other satinising machines

FINIMASTER BASIC

SISAL

FINIMASTER BASIC - SISAL



diameter	width	centre hole	type	code	stock	
Ø 100	100	19,6	Sisal	FMSS100100	●	1

FINIMASTER BASIC

COTTON

FINIMASTER BASIC - COTTON



diameter	width	centre hole	type	code	stock	
Ø 100	100	19,6	White cotton	FMPR100100	●	1
Ø 100	12	19,6	White cotton	FMPR10012	●	8

FINIMASTER BASIC

FELT

FINIMASTER BASIC - FELT



diameter	width	centre hole	type	code	stock	
Ø 100	50	19,6	Felt	FMVR10050	●	2

> Finimaster wheels

FINIMASTER PRO

COTTON

FINIMASTER PRO - COTTON



diameter	width	attach-ment	type	code	stock	
Ø 125	110	M14	White cotton	FMPM125110	●	1
Ø 125	50	M14	White cotton	SUM12550	●	1



Did you know that 50 mm wide wheels can be easily mounted on your adjustable angle grinder in order to achieve a high glossy finish with reasonably simple tools?

Finimaster wheels

FINIMASTER PRO - FLANNEL

diameter	width	attach-ment	type	code	stock	
Ø 125	50	M14	Flannel	FLM12550	●	1

FLANNEL

FINIMASTER PRO



Felt discs

VELCRO BACKED FELT DISC

Applications: Polishing plastic, stainless steel, lacquer (auto repair)

Use:

- To be used with polishing paste (see p. 375)
- Mount on velcro back-up pads

diameter	thickness	density	code	code back-up pad	stock	
Ø 115	3mm	Soft	PVG/Z/115	115VELSUPERXM	●	10
	5mm	Hard	PVG/H/115		●	10
Ø 125	3mm	Soft	PVG/Z/125	125VELSUPERXM	●	10
	5mm	Hard	PVG/H/125		●	10
Ø 150	3mm	Soft	PVG/Z/150	150VELSUPERXM	●	10
	5mm	Hard	PVG/H/150		●	10
Ø 180	3mm	Soft	PVG/Z/180	178VELSUPERXM	●	10
	5mm	Hard	PVG/H/180		●	10

FELT

VELCRO BACKED



Additional information about the back-up pads can be found in the accessories section.

FELT DISC - M14

Properties: Hard fixed felt disc

Applications: Polishing natural stone, lacquer (auto repair), metal, stainless steel, plastics

Use: To be used with polishing paste (see p. 375)

diameter	thickness	density	code	stock	
Ø 125	25	Hard	PVM12525	●	1
Ø 178	25	Hard	PVM17825	●	1

FELT

M14



● = available from stock

● = available in 5 working days

● = on request

> Felt wheels

FELT



FINIT-EASY

diam.	width	centre hole	den- sity	code	stock	
Ø 150	5	25,4	600	MHV5600/T31	●	6



Mount the super thin polishing wheel on the Finit-Easy and make even the most inaccessible corners shine. Together with this ingenious extension arm, the polishing wheel is the ideal combination for polishing inside corners and other hard-to-reach locations. This way you can always finish your workpiece flawlessly, down to the smallest detail.

> Mounted felt points

STRAIGHT



STRAIGHT

diameter	height	shape	code	spindle	stock	
Ø 15	15	Straight	PVS/RE/151503	3	●	10
Ø 15	25	Straight	PVS/RE/152506	6	●	10
Ø 20	30	Straight	PVS/RE/203006	6	●	10
Ø 25	40	Straight	PVS/RE/254006	6	●	10
Ø 30	50	Straight	PVS/RE/305006	6	●	10

CONICAL



CONICAL

diameter	height	shape	code	spindle	stock	
Ø 15	15	Conical	PVS/CO/151503	3	●	10
Ø 15	25	Conical	PVS/CO/152506	6	●	10
Ø 20	30	Conical	PVS/CO/203006	6	●	10
Ø 25	40	Conical	PVS/CO/254006	6	●	10
Ø 30	50	Conical	PVS/CO/305006	6	●	10



For other references, please consult Cibo.

➤ Mounted felt points

POINT

diameter	height	shape	code	spindle	stock	
Ø 15	25	Point	PVS/PU/152506	6	●	10
Ø 20	30	Point	PVS/PU/203006	6	●	10
Ø 25	40	Point	PVS/PU/254006	6	●	10
Ø 30	50	Point	PVS/PU/305006	6	●	10

POINT



BALL

diameter	shape	code	spindle	stock	
Ø 25	Ball	PVS/BO/2506	6	●	10
Ø 30	Ball	PVS/BO/3006	6	●	10

BALL



Caution! Increased pressure can never compensate for grinding lines that are too deep. Careful preparation is therefore very important. Limit the pressure exerted. Excessive pressure can lead to excessive heat generation and overheating of the polishing materials. The best way to remove deep grinding lines is by using reinforced cotton mounting points. See p. 359.

● = available from stock

● = available in 5 working days

● = on request

> Compound sponges

COMPOUND SPONGES



COMPOUND SPONGES

- Properties:**
- Yellow: aggressive sponge with open cell structure for severely damaged lacquer
 - White: firm sponge with closed cell structure for general use with the most common compound and polishing brands
 - Blue: softer sponge with open cell structure for use on cellulose and acrylic lacquer
 - Black: extremely soft sponge, excellent for dark lacquer and delicate work
- Applications:**
- Polishing away scratches from lacquer, a.o. car repair
 - Buffing cars, caravans, boats, etc.

To be mounted on: Slow speed machines e.g. Finipower

diameter	attachment	type	code	stock	
Ø 150	grip	White	PCG/W/150	●	1
Ø 150	M14	White	PCM/W/150	●	1
Ø 150	grip	Blue	PCG/B/150	●	1
Ø 150	M14	Blue	PCM/B/150	●	1
Ø 150	W5/8"	Blue	PCW/B/150	●	1
Ø 150	grip	Black	PCG/Z/150	●	1
Ø 150	M14	Black	PCM/Z/150	●	1
Ø 150	W5/8"	Yellow	PCW/G/150	●	1
Ø 150	grip	Yellow	PCG/G/150	●	1
Ø 150	M14	Yellow	PCM/G/150	●	1

> Lambswool polishing bonnet with stretch cord

LAMBS WOOL BONNET



LAMBSWOOL

Applications: High polish of lacquer (car repair)

To be mounted on: Slow speed machines e.g. Finipower

Use: The lambswool bonnet is attached to all common back-up pads using the stretch cord.

diameter	code	stock	
Ø 115	PSS115	●	1
Ø 125	PSS125	●	1
Ø 150	PSS150	●	1
Ø 180	PSS180	●	1
Ø 200	PSS200	●	1
Ø 235	PSS235	●	1

> Polishing paste

POLISHING PASTE



LIQUID POLISHING PASTE

Applications: • High-gloss polishing of lacquer (car repair, boats, ...)
• Make plexiglas shine again

Use: In combination with compound sponges and lambswool

type	code	stock	
1000	PVL1000	●	1
2000	PVL2000	●	1
3000	PVL3000	●	1



PVL1000 can remove scratches caused by a P1000 grit type, PVL2000 can remove scratches caused by a P2000 grit type and PVL3000 removes scratches from a P3000 grit type. The PVL3000 was specially developed to handle even the strongest scratch-resistant types of lacquer. Scratches in very hard types of lacquer are removed in seconds, without shadows and bringing back the original shine.

LIQUID POLISHING PASTE

Low High

	Cutting rate	Gloss rate	Silicone content	Ideal processing speed
PVL1000			0%	1,000 – 1,500 RPM
PVL2000			0%	1,000 – 1,500 RPM
PVL3000			0%	1,000 – 1,500 RPM

> Inoxiclean

INOXICLEAN CHALK



INOXICLEAN CHALK (VIENNA CHALK)

Applications: Removing polishing paste residue after polishing operations

code	stock	
PV103	●	±300 g



Remove the polishing pastes only using Vienna chalk and a very soft, clean piece of cloth (e.g. microfiber or flannel). This chalk degreases and ensures you can easily remove the paste residue without making any new scratches on the workpiece.

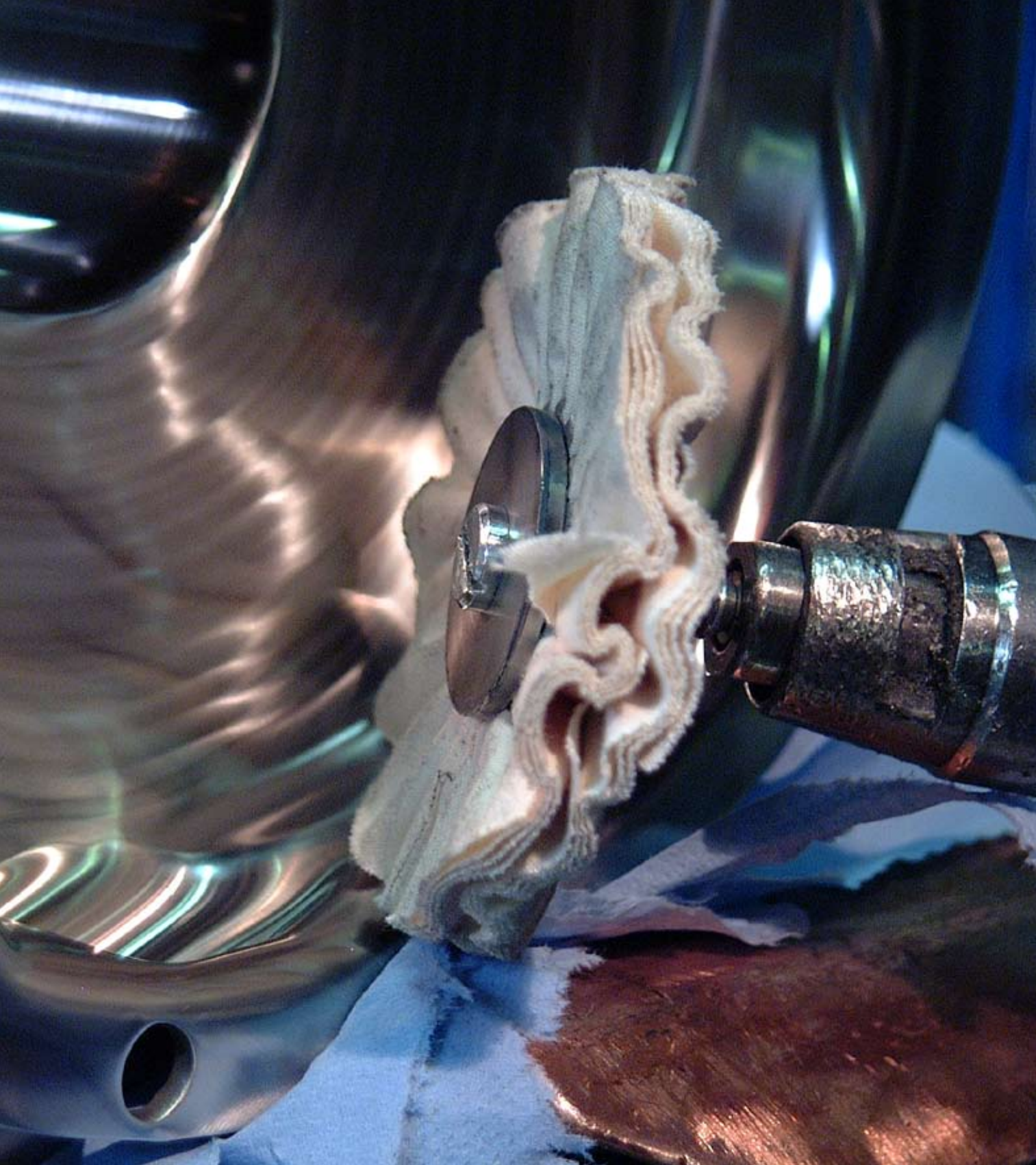

FOAM

- Sanding blocks 380
- Foam blocks 380
- Foam pads 381
- Hi-flex pads 381
- Easy-Foam 382
- A275-Foam 383

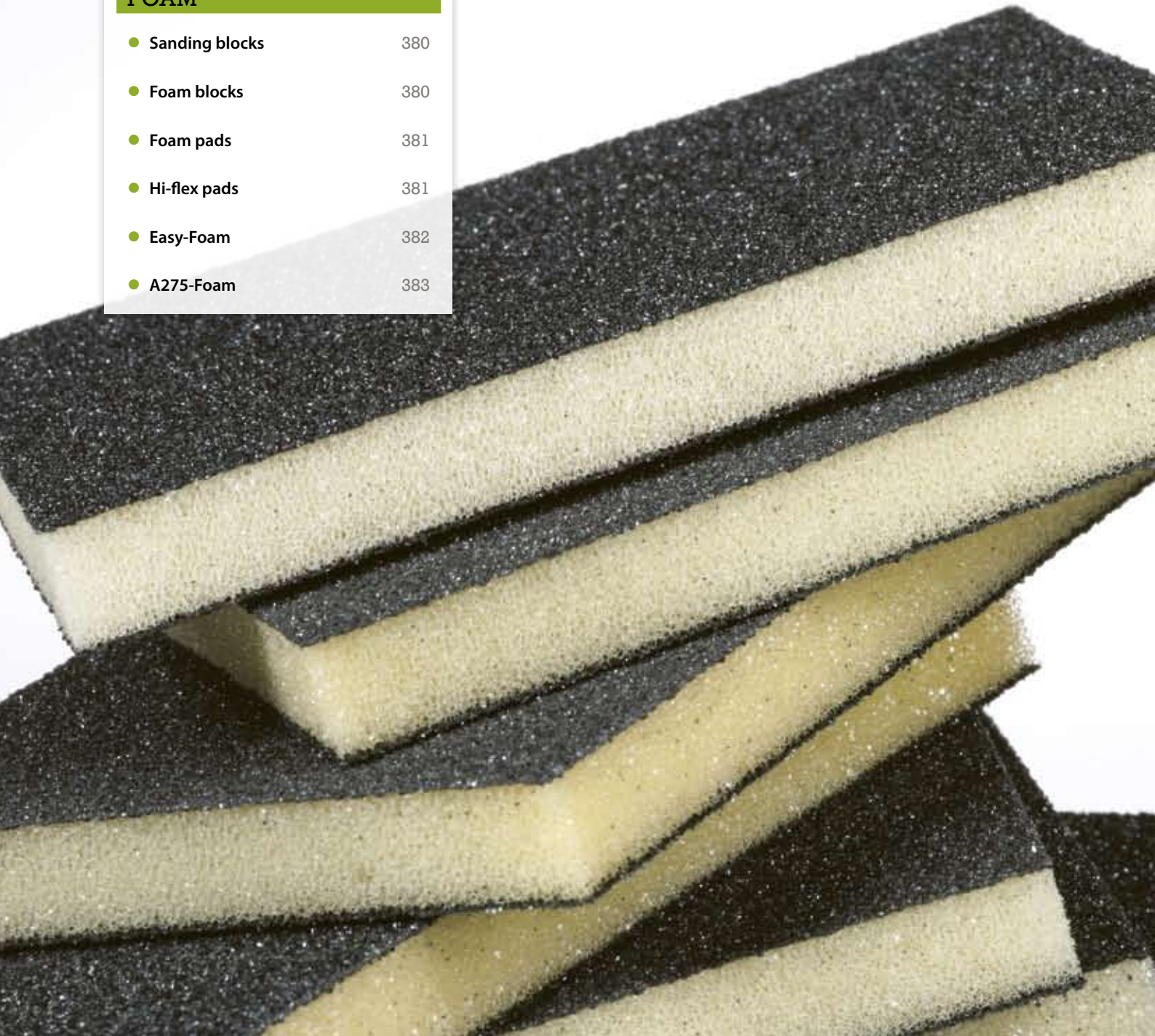

The image shows two cross-sections of foam materials. The top section consists of two layers: a dark, textured top layer and a lighter, porous bottom layer. The bottom section also consists of two layers: a dark, textured top layer and a lighter, porous bottom layer. The word "FOAM" is centered in the middle of the page, with a horizontal line underneath it.

FOAM

SANDING BLOCKS



> Rubber-bonded sanding blocks

SANDING BLOCK

- Properties:**
- Universal use
 - Ground finish 320 can be achieved with grit type 60
- Applications:** Applying manual line structure on stainless steel

dimensions	thickness	grit	code	stock	
80x50	20	30	FORU/30	●	1
80x50	20	60	FORU/60	●	1
80x50	20	120	FORU/120	●	1
80x50	20	240	FORU/240	●	1

 The sanding block allows you to remove minor scratches in brushed stainless steel.

BLOCKS



> Foam blocks

THICK FOAM WITH 4-SIDED SPRAYED GRIT

- Properties:**
- Grit is applied on 4 sides
 - No distortions and still flexible
 - Can be used wet and dry
 - Washable and reusable
- Applications:**
- The lateral surfaces of the foam blocks provide a fantastic result in grooves
 - Grinding hard-to-reach locations, corners and decorative frames

dimensions	thickness	grit	code	stock	
100x68	27	60	FOBL/60	●	250
100x68	27	60/100	FOBL/60/100	●	250
100x68	27	100	FOBL/100	●	250
100x68	27	120	FOBL/120	●	250
100x68	27	180	FOBL/180	●	250
100x68	27	220	FOBL/220	●	250

 Cibo foam materials increase your grinding comfort and improve the finish.

> Foam pads

SOFT FOAM DOUBLE COATED SPRAYED GRIT

- Properties:**
- Grit is applied to 2 sides
 - Very flexible
 - Adapts effortlessly to the workpiece
 - Can be used both dry and wet
 - Washable and reusable

- Applications:**
- Grinding and refining rounded and idiosyncratic workpieces in the furniture industry and auto repair
 - Often used on rattan and bamboo furniture

dimensions	thickness	grit	code	stock	
123x96	12,5	60	FOPA/60	●	250
123x96	12,5	80	FOPA/80	●	250
123x96	12,5	100	FOPA/100	●	250
123x96	12,5	120	FOPA/120	●	250
123x96	12,5	180	FOPA/180	●	250
123x96	12,5	220	FOPA/220	●	250

PADS

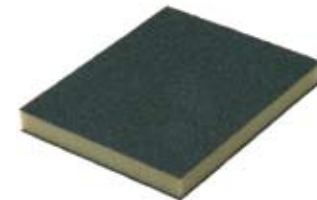

> Hi-flex pads

VERY THIN FOAM BASE LAYER WITH GRIT ON ONE SIDE

- Properties:**
- Washable and reusable
 - Both for dry and wet grinding

- Application:**
- Finishing rounded materials
 - Refining lacquer and varnish

dimensions	thickness	grit	code	stock	
140x115	6	60	FOHI/60	●	100
140x115	6	100	FOHI/100	●	100
140x115	6	180	FOHI/180	●	100
140x115	6	280	FOHI/280	●	100

HI-FLEX PADS



● = available from stock

● = available in 5 working days

● = on request

ROLLS



➤ Easy-Foam/paper – handy and economical

ROLL OF 25MX115MM, CONSISTING OF 178 PRE-PERFORATED SHEETS (115X140MM) SUPPLIED IN A HANDY DISPENSER BOX.

- Properties:**
- Handy and economical
 - Dirt repellent and cool action
 - Very long lifespan
 - One-sided use
 - Adapts perfectly to the shape of the workpiece
 - Pleasant in use, soft to the touch
 - Available in a handy dispenser box
- Applications:**
- Manual use
 - Irregular shapes on wood, lacquer, PVC and metal
 - Very good results on lacquer, primers and MDF
 - Auto repair
 - Rattan and bamboo furniture

dimensions	grit	code	stock	
25000x115	80	FOIM/80/25115	●	1
25000x115	120	FOIM/120/25115	●	1
25000x115	180	FOIM/180/25115	●	1
25000x115	220	FOIM/220/25115	●	1
25000x115	320	FOIM/320/25115	●	1
25000x115	400	FOIM/400/25115	●	1
25000x115	500	FOIM/500/25115	●	1



> A275 Foam/paper

A275 PAPER, LAMINATED ON FLEXIBLE FOAM RUBBER

- Properties:**
- Dirt-repellent and cool action
 - Very long lifespan
 - One-sided use
 - Adapts perfectly to the shape of the workpiece
 - Pleasant in use, soft to the touch
- Applications:**
- Manual use
 - Irregular shapes on wood, lacquer, PVC and metal
 - Very good results on lacquer, primers and MDF
 - Auto repair
 - Rattan and bamboo furniture

PAPER



dimensions	grit	code	stock	
140x115	180	FO295/180/140115	●	25
140x115	220	FO295/220/140115	●	25
140x115	320	FO295/320/140115	●	25
280x230	180	FO295/180/280230	●	25
280x230	220	FO295/220/280230	●	25
280x230	320	FO295/320/280230	●	25
280x115	180	FO295/180/280115	●	25
280x115	220	FO295/220/280115	●	25
280x115	320	FO295/320/280115	●	25



● = available from stock

● = available in 5 working days

● = on request

SLEEVES

- **Spirabands** 386
 - **Spiral** 386
 - Zirconium oxide 386
 - Aluminium oxide 388
 - **Sleeves** 389
 - Aluminium oxide 389
 - Zirconium oxide 389
- **Cartridge rolls** 390
 - **Straight** 390
 - **Tapered** 391
- **Abrasive caps** 392
 - **Flat** 392
 - **Round** 393
 - **Point** 394
 - **Conical** 395
 - **Cone** 395



Other sizes and grit are also available.
Cibo can manufacture any grade and size you can think of.



SLEEVES



> Spirabands

ZIRCONIUM OXIDE

SPIRAL

CYLINDRICAL SLEEVES – ZIRCONIUM OXIDE

Properties: Good stock removal at high speeds

Applications: Stainless steel, mould construction, aerospace industry, model building, wood and plastic industries, etc.



diameter	height	grit	code	type	code support	stock	
Ø 10	20	40	SHS/40/1020	Zirc.	SHSH1020	●	100
	20	60	SHS/60/1020	Zirc.	SHSH1020	●	100
	20	80	SHS/80/1020	Zirc.	SHSH1020	●	100
	20	150	SHS/150/1020	Zirc.	SHSH1020	●	100
Ø 15	30	40	SHS/40/1530	Zirc.	SHSH1530	●	100
	30	60	SHS/60/1530	Zirc.	SHSH1530	●	100
	30	80	SHS/80/1530	Zirc.	SHSH1530	●	100
	30	150	SHS/150/1530	Zirc.	SHSH1530	●	100
Ø 22	20	40	SHS/40/2220	Zirc.	SHSH2220	●	100
	20	60	SHS/60/2220	Zirc.	SHSH2220	●	100
	20	80	SHS/80/2220	Zirc.	SHSH2220	●	100
	20	150	SHS/150/2220	Zirc.	SHSH2220	●	100
Ø 30	30	40	SHS/40/3030	Zirc.	SHSH3030	●	100
	30	60	SHS/60/3030	Zirc.	SHSH3030	●	100
	30	80	SHS/80/3030	Zirc.	SHSH3030	●	100
	30	150	SHS/150/3030	Zirc.	SHSH3030	●	100
Ø 45	30	40	SHS/40/4530	Zirc.	SHSH4530	●	100
	30	60	SHS/60/4530	Zirc.	SHSH4530	●	100
	30	80	SHS/80/4530	Zirc.	SHSH4530	●	100
	30	150	SHS/150/4530	Zirc.	SHSH4530	●	100
Ø 60	30	40	SHS/40/6030	Zirc.	SHSH6030	●	100
	30	60	SHS/60/6030	Zirc.	SHSH6030	●	100
	30	80	SHS/80/6030	Zirc.	SHSH6030	●	100
	30	150	SHS/150/6030	Zirc.	SHSH6030	●	100



Spirasupports: see also accessories, p. 487



The centrifugal tension of the abrasive holder ensures that the abrasive sleeves are automatically clamped tight.



Did you know there are double wound abrasive sleeves with a ceramic grit?
Please consult Cibo for the available sizes and grit.



ADVICE ON USER SPEEDS OF SPIRAL SLEEVES

	min/max RPM	recommended RPM		min/max RPM	recommended RPM
Ø 10	30.000 - 45.000	40.000	Ø 45	9.000 - 13.000	11.500
Ø 15	25.000 - 35.000	30.000	Ø 60	6.300 - 9.600	8.500
Ø 22	19.000 - 26.000	23.000	Ø 75	5.000 - 7.500	6.500
Ø 30	13.000 - 19.000	17.000			



Respecting the minimum speed ensures that the abrasive sleeves are firmly attached to the holders.

● = available from stock

● = available in 5 working days

● = on request

> Spirabands

ALUMINIUM OXIDE

SPIRAL

CYLINDRICAL SLEEVES – ALUMINIUM OXIDE



- Properties:**
- Are mainly used on wood
 - Good stock removal at high speeds
- Applications:** Artisan furniture manufacturing, restoration of antiques, style furniture manufacturing, instruments, model making, artisanal woodwork, etc.

diameter	height	grit	code	type	stock	
Ø 20	120	40	SHS/40/20120	Al.-Ox.	●	25
	120	60	SHS/60/20120	Al.-Ox.	●	25
	120	80	SHS/80/20120	Al.-Ox.	●	25
	120	120	SHS/120/20120	Al.-Ox.	●	25
Ø 25	120	40	SHS/40/25120	Al.-Ox.	●	25
	120	60	SHS/60/25120	Al.-Ox.	●	25
	120	80	SHS/80/25120	Al.-Ox.	●	25
	120	120	SHS/120/25120	Al.-Ox.	●	25
Ø 30	120	40	SHS/40/30120	Al.-Ox.	●	25
	120	60	SHS/60/30120	Al.-Ox.	●	25
	120	80	SHS/80/30120	Al.-Ox.	●	25
	120	120	SHS/120/30120	Al.-Ox.	●	25
Ø 35	120	40	SHS/40/35120	Al.-Ox.	●	15
	120	60	SHS/60/35120	Al.-Ox.	●	15
	120	80	SHS/80/35120	Al.-Ox.	●	15
	120	120	SHS/120/35120	Al.-Ox.	●	15
Ø 40	120	40	SHS/40/40120	Al.-Ox.	●	15
	120	60	SHS/60/40120	Al.-Ox.	●	15
	120	80	SHS/80/40120	Al.-Ox.	●	15
	120	120	SHS/120/40120	Al.-Ox.	●	15
Ø 45	120	40	SHS/40/45120	Al.-Ox.	●	12
	120	60	SHS/60/45120	Al.-Ox.	●	12
	120	80	SHS/80/45120	Al.-Ox.	●	12
	120	120	SHS/120/45120	Al.-Ox.	●	12
Ø 50	120	40	SHS/40/50120	Al.-Ox.	●	10
	120	60	SHS/60/50120	Al.-Ox.	●	10
	120	80	SHS/80/50120	Al.-Ox.	●	10
	120	120	SHS/120/50120	Al.-Ox.	●	10

> Sleeves

CYLINDRICAL SLEEVES – ALUMINIUM OXIDE

Properties:

- Seamless and perfect finish
- Manufactured from flexible abrasive cloth

Use: With a very soft abrasive holder (30° Shore)

diameter	height	grit	code	type	code support	stock	
Ø 75	30	60	SHE/60/7530	Al.-Ox.	SHEH7530	●	100
	30	80	SHE/80/7530	Al.-Ox.	SHEH7530	●	100
	30	120	SHE/120/7530	Al.-Ox.	SHEH7530	●	100
	30	150	SHE/150/7530	Al.-Ox.	SHEH7530	●	100
	30	180	SHE/180/7530	Al.-Ox.	SHEH7530	●	100
	30	220	SHE/220/7530	Al.-Ox.	SHEH7530	●	100



Supports: see also accessories, p. 487

SLEEVES

ALUMINIUM OXIDE



CONICAL SLEEVES – ZIRCONIUM OXIDE

Properties: Good grinding efficiency at high speeds

Applications: Stainless steel, mould construction, aerospace industry, model building, wood and plastic industries, etc.

diameter	height	grit	code	type	code support	stock	
Ø 22	30	40	SHC/40/2230	Zirc.	SHCH2230	●	25
	30	60	SHC/60/2230	Zirc.	SHCH2230	●	25
	30	80	SHC/80/2230	Zirc.	SHCH2230	●	25
	30	120	SHC/120/2230	Zirc.	SHCH2230	●	25
	60	40	SHC/40/2260	Zirc.	SHCH2260	●	25
	60	60	SHC/60/2260	Zirc.	SHCH2260	●	25
	60	80	SHC/80/2260	Zirc.	SHCH2260	●	25
	60	120	SHC/120/2260	Zirc.	SHCH2260	●	25



Supports: see also accessories, p. 487

SLEEVES

ZIRCONIUM OXIDE



● = available from stock

● = available in 5 working days

● = on request

> Cartridge rolls

ALUMINIUM OXIDE

STRAIGHT

CARTRIDGE ROLLS STRAIGHT



Description: Rolled abrasive cloth in cylindrical version

- Properties:**
- Quick to change
 - New abrasive material continuously released
 - Constant finish
 - Work comfortably, free from vibration

Applications: Grinding down weld seams in corners in hard-to-reach locations, grinding and deburring internally, working round, hollow and idiosyncratic workpieces, finishing moulds, etc.

diameter	height	grit	code	type	code support	stock	
Ø 6	25	40	SRR/40/0625	Al.-Ox.	MHS18 / MHS19	●	100
	25	60	SRR/60/0625	Al.-Ox.	MHS18 / MHS19	●	100
	25	120	SRR/120/0625	Al.-Ox.	MHS18 / MHS19	●	100
	25	220	SRR/220/0625	Al.-Ox.	MHS18 / MHS19	●	100
	38	60	SRR/60/0638	Al.-Ox.	MHS18 / MHS19	●	100
	50	80	SRR/80/0650	Al.-Ox.	MHS18 / MHS19	●	100
Ø 8	25	40	SRR/40/0825	Al.-Ox.	MHS18 / MHS19	●	100
	25	60	SRR/60/0825	Al.-Ox.	MHS18 / MHS19	●	100
	25	120	SRR/120/0825	Al.-Ox.	MHS18 / MHS19	●	100
Ø 9	35	60	SRR/60/0935	Al.-Ox.	MHS18 / MHS19	●	100
Ø 10	38	40	SRR/40/1038	Al.-Ox.	MHS18 / MHS19	●	100
	50	60	SRR/60/0950	Al.-Ox.	MHS18 / MHS19	●	100
Ø 13	25	40	SRR/40/1325	Al.-Ox.	MHS18 / MHS19	●	100
	25	60	SRR/60/1325	Al.-Ox.	MHS18 / MHS19	●	100
	25	120	SRR/120/1325	Al.-Ox.	MHS18 / MHS19	●	100
	25	220	SRR/220/1325	Al.-Ox.	MHS18 / MHS19	●	100
	38	40	SRR/40/1338	Al.-Ox.	MHS18 / MHS19	●	100
Ø 19	38	60	SRR/60/1338	Al.-Ox.	MHS18 / MHS19	●	100
	38	80	SRR/80/1338	Al.-Ox.	MHS18 / MHS19	●	100
	38	40	SRR/40/1938	Al.-Ox.	MHS18 / MHS19	●	50
Ø 25	38	60	SRR/60/1938	Al.-Ox.	MHS18 / MHS19	●	50
	50	60	SRR/60/19503	Al.-Ox.	MHS18 / MHS19	●	25
	25	40	SRR/40/2525	Al.-Ox.	MHS18 / MHS19	●	25
	25	60	SRR/60/2525	Al.-Ox.	MHS18 / MHS19	●	25
	25	120	SRR/120/2525	Al.-Ox.	MHS18 / MHS19	●	25

MHS 18 SUPPORT

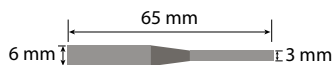

MHS 19 SUPPORT



Supports: see also accessories, p. 481

> Cartridge rolls

CARTRIDGE ROLLS TAPERED

Description: Rolled abrasive cloth in tapered version

- Properties:**
- Quick to change
 - Continuous release of new abrasive material
 - Constant finish
 - Work comfortably, free from vibration

Applications: Grinding down weld seams in corners, removing unevenness, grinding and deburring internally, working on round, hollow and uneven workpieces, finishing moulds, etc.

diameter	height	grit	code	type	code support	stock	
Ø 13	25	60	SRK/60/1325	Al.-Ox.	MHS18 / MHS19	●	100
	25	80	SRK/80/1325	Al.-Ox.	MHS18 / MHS19	●	100
	25	120	SRK/120/1325	Al.-Ox.	MHS18 / MHS19	●	100
	25	220	SRK/220/1325	Al.-Ox.	MHS18 / MHS19	●	100
	50	80	SRK/80/1350	Al.-Ox.	MHS18 / MHS19	●	50
Ø 16	25	40	SRK/40/1625	Al.-Ox.	MHS18 / MHS19	●	50
	25	60	SRK/60/1625	Al.-Ox.	MHS18 / MHS19	●	50
	25	80	SRK/80/1625	Al.-Ox.	MHS18 / MHS19	●	50
	25	120	SRK/120/1625	Al.-Ox.	MHS18 / MHS19	●	50
Ø 19	25	40	SRK/40/1925	Al.-Ox.	MHS18 / MHS19	●	50
	25	60	SRK/60/1925	Al.-Ox.	MHS18 / MHS19	●	50
	25	80	SRK/80/1925	Al.-Ox.	MHS18 / MHS19	●	50
	25	120	SRK/120/1925	Al.-Ox.	MHS18 / MHS19	●	50

TAPERED

ALUMINIUM OXIDE



Supports: see also accessories, p. 481



Cartridge rolls: Recommended speed: 8 to 10 m/s Max. speed: 11 m/s



Sizes and grit types not mentioned in the table can be ordered. Contact us for more information!

● = available from stock

● = available in 5 working days

● = on request

> Abrasive caps

ALUMINIUM OXIDE

FLAT

ABRASIVE CAPS FLAT



- Properties:**
- Very efficient for all grinding and deburring operations in hard-to-reach locations
 - Working with crosscut side also possible
 - Quick to change
 - Available in various grit sizes

Applications: Tool manufacture, moulds, precision mechanics, making models and miniatures, aerospace industry, etc.

diameter	height	grit	code	type	code support	stock	
Ø 5	10	80	SKV/80/0510	Al.-Ox.	SKVH0510	●	100
	10	150	SKV/150/0510	Al.-Ox.	SKVH0510	●	100
Ø 7	12	80	SKV/80/0712	Al.-Ox.	SKVH0712	●	100
	12	150	SKV/150/0712	Al.-Ox.	SKVH0712	●	100
Ø 10	15	80	SKV/80/1015	Al.-Ox.	SKVH1015	●	100
	15	150	SKV/150/1015	Al.-Ox.	SKVH1015	●	100
Ø 13	17	80	SKV/80/1317	Al.-Ox.	SKVH1317	●	100
	17	150	SKV/150/1317	Al.-Ox.	SKVH1317	●	100
Ø 16	26	80	SKV/80/1626	Al.-Ox.	SKVH1626	●	100
	26	150	SKV/150/1626	Al.-Ox.	SKVH1626	●	100



Mandrels: see also accessories p. 486



For other references, please consult Cibo.

> Abrasive caps

ABRASIVE CAPS ROUND

- Properties:**
- Very efficient for all grinding and deburring operations in hard-to-reach locations
 - Working with crosscut side also possible
 - Quick to change
 - Available in various grit sizes

Applications: Tool manufacture, moulds, precision mechanics, making models and miniatures, aerospace industry, etc.

diameter	height	grit	code	type	code support	stock	
Ø 5	11	80	SKB/80/0511	Al.-Ox.	SKBH0511	●	100
	11	150	SKB/150/0511	Al.-Ox.	SKBH0511	●	100
Ø 7	13	60	SKB/60/0713	Al.-Ox.	SKBH0713	●	100
		80	SKB/80/0713	Al.-Ox.	SKBH0713	●	100
	13	150	SKB/150/0713	Al.-Ox.	SKBH0713	●	100
Ø 10	15	60	SKB/60/1015	Al.-Ox.	SKBH1015	●	100
		80	SKB/80/1015	Al.-Ox.	SKBH1015	●	100
	15	150	SKB/150/1015	Al.-Ox.	SKBH1015	●	100
Ø 13	19	80	SKB/80/1319	Al.-Ox.	SKBH1319	●	100
		150	SKB/150/1319	Al.-Ox.	SKBH1319	●	100
Ø 16	26	80	SKB/80/1626	Al.-Ox.	SKBH1626	●	100
		150	SKB/150/1626	Al.-Ox.	SKBH1626	●	100

ROUND

ALUMINIUM OXIDE



Mandrels: see also accessories p. 486

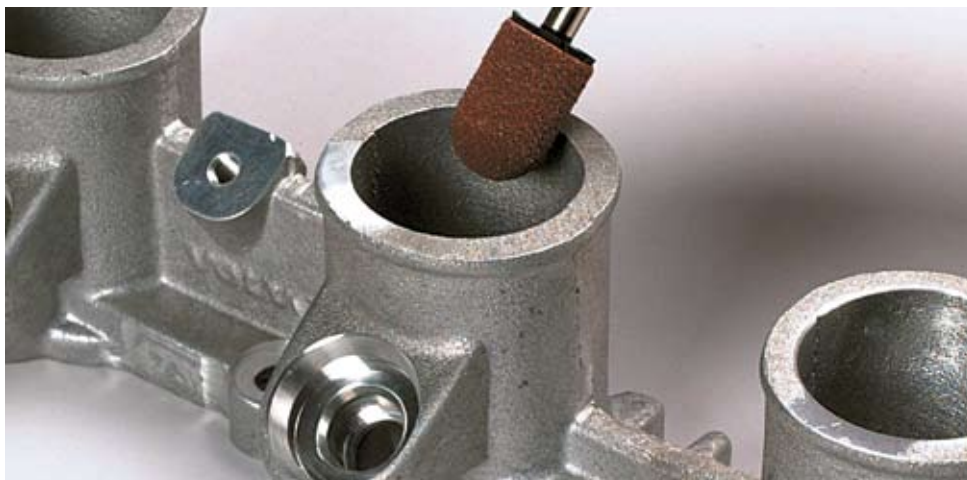

● = available from stock

● = available in 5 working days

● = on request

ALUMINIUM OXIDE

POINT

> Abrasive caps

ABRASIVE CAPS POINTED

- Properties:**
- Very efficient for all grinding and deburring operations in hard-to-reach locations
 - Working with crosscut side also possible
 - Quick to change
 - Available in various grit sizes

Applications: Tool manufacture, moulds, precision mechanics, making models and miniatures, aerospace industry, etc.



diameter	height	grit	code	type	code support	stock	
Ø 10	15	80	SKP/80/1015	Al.-Ox.	SKPH1015	●	100
	15	150	SKP/150/1015	Al.-Ox.	SKPH1015	●	100
Ø 16	26	80	SKP/80/1626	Al.-Ox.	SKPH1626	●	100
	26	150	SKP/150/1626	Al.-Ox.	SKPH1626	●	100



Mandrels: see also accessories p. 486



➤ Abrasive caps

ABRASIVE CAPS CONICAL

- Properties:**
- Very efficient for all grinding and deburring operations in hard-to-reach locations
 - Working with crosscut side also possible
 - Quick to change
 - Available in various grit sizes

Applications: Tool manufacture, moulds, precision mechanics, making models and miniatures, aerospace industry, etc.

diameter	height	grit	code	type	code support	stock	
Ø 16	32	60	SKC/60/1632	Al.-Ox.	SKCH1632	●	25
	32	80	SKC/80/1632	Al.-Ox.	SKCH1632	●	25
	32	150	SKC/150/1632	Al.-Ox.	SKCH1632	●	25
Ø 21	40	60	SKC/60/2140	Al.-Ox.	SKCH2140	●	25
	40	80	SKC/80/2140	Al.-Ox.	SKCH2140	●	25
	40	150	SKC/150/2140	Al.-Ox.	SKCH2140	●	25



Mandrels: see also accessories p. 486

CONICAL

ALUMINIUM OXIDE



ABRASIVE CAPS CONE

- Properties:**
- Very efficient for all grinding and deburring work in hard-to-reach locations
 - Quick to change
 - Available in various grit sizes

Applications: Tool manufacture, moulds, precision mechanics, making models and miniatures, aerospace industry, etc.

diameter	height	grit	code	type	code support	stock	
Ø 8	85	80	SHK/80/0885	Al.-Ox.	SHKH0885	●	25
	85	150	SHK/150/0885	Al.-Ox.	SHKH0885	●	25
Ø 18	85	80	SHK/80/1885	Al.-Ox.	SHKH1885	●	25
	85	150	SHK/150/1885	Al.-Ox.	SHKH1885	●	25



Mandrels: see also accessories p. 487

CONE

ALUMINIUM OXIDE



For other references, please consult Cibo.

● = available from stock

● = available in 5 working days

● = on request

BRUSHES

- **Steel wire brushes** 398
 - **Wheel** 398
 - With centre hole 398
 - Spindle mounted 398
 - **End** 400
 - Spindle mounted 400
 - **Cup** 400
 - Spindle mounted 400
 - M14 401
 - With centre hole 401
 - **Bevel** 402
 - M14 402
 - **Hand brushes** 402
- **Stainless steel wire brushes** 403
 - **Wheel** 403
 - White centre hole 403
 - Spindle mounted 403
 - **End** 404
 - Spindle mounted 404
 - **Cup** 405
 - M14 405
 - **Hand brushes** 405
- **Grittyflex brushes** 406
 - **Wheel** 406
 - Spindle mounted 406
 - **End** 406
 - Spindle mounted 406
 - **Cup** 406
 - Spindle mounted 406
- **Schmilon brushes** 407
 - **Wheel** 407
 - With centre hole 407
 - **Tube** 407
 - Spindle mounted 407
- **Reduction rings** 408



BRUSHES



Steel wire brushes

WITH CENTRE HOLE

WHEEL BRUSHES



WHEEL BRUSH STEEL CRIMPED WIRE

diameter	width	centre hole	wire thickness	wire length	code	stock	
Ø 100	20	20	0,3	23	BRSA10020*	●	1
Ø 125	22	20	0,3	30	BRSA12522*	●	1
Ø 150	30	31,75	0,3	29	BRSA15030**	●	1
Ø 178	32	31,75	0,3	38	BRSA17832**	●	1
Ø 200	30	31,75	0,3	38	BRSA20030**	●	1
Ø 250	38	50,8	0,35	47	BRSA25038***	●	1

* These brushes are supplied with 1/2" and 5/8" reduction rings.

** These brushes are supplied with 13 mm, 15 mm, 16 mm, 19 mm, 20 mm, 7/8" and 1" reduction rings.

*** For these brushes, the desired shaft diameter is listed between 20 mm and 50.8 mm.

WITH CENTRE HOLE

WHEEL BRUSHES



WHEEL BRUSH STEEL KNOTTED WIRE

diameter	width	centre hole	wire thickness	wire length	code	stock	
Ø 100	12	22,2	0,5	20	BTSA10012	●	1
Ø 115	12	M14	0,5	23	BTSM11512	●	1
Ø 115	12	22,2	0,5	23	BTSA11512	●	1
Ø 150	13	22,2	0,35	37	BTSA15013	●	1
Ø 178	13	22,2	0,35	42	BTSA17813	●	1
Ø 200	13	40	0,35	42	BTSA20013*	●	1

* For this brush, the desired shaft diameter is listed between 20 mm and 40 mm.

SPINDLE MOUNTED

WHEEL BRUSHES



WHEEL BRUSH STEEL CRIMPED WIRE SPINDLE MOUNTED

diameter	width	spindle diameter	wire thickness	wire length	code	stock	
Ø 50	10	6	0,3	13	BRSS5010	●	10
Ø 60	12	6	0,3	15	BRSS6012	●	10
Ø 60	18	6	0,3	15	BRSS6018	●	10
Ø 70	18	6	0,3	15	BRSS7018	●	10
Ø 80	19	6	0,3	20	BRSS8019	●	10



For other references, please consult Cibo.

● = available from stock

● = available in 5 working days

● = on request

Steel wire brushes

SPINDLE MOUNTED

END BRUSHES



END BRUSH STEEL CRIMPED WIRE

diameter	spindle diameter	wire thickness	wire lenght	code	max RPM	stock	
Ø 17	6	0,2	25	BRSP17	18.000	●	12

SPINDLE MOUNTED

END BRUSHES



END BRUSH STEEL KNOTTED WIRE

diameter	spindle diameter	wire thickness	wire lenght	code	max RPM	stock	
Ø 23	6	0,26	29	BTSP23	20.000	●	12

SPINDLE MOUNTED

CUP BRUSHES



CUP BRUSH STEEL CRIMPED WIRE

diameter	spindle diameter	wire thickness	code	stock	
Ø 75	6	0,3	BKSS75	●	10



Steel wire brushes

CUP BRUSH STEEL M14 CRIMPED WIRE

diameter	attach- ment	wire thickness	code	stock	
Ø 60	M14	0,3	BKRSM60	●	1
Ø 80	M14	0,3	BKRSM80	●	1
Ø 100	M14	0,3	BKRSM100	●	1
Ø 125	M14	0,3	BKRSM125	●	1

CUP BRUSHES

M14



CUP BRUSH STEEL M14 KNOTTED WIRE

diameter	attach- ment	wire thickness	code	stock	
Ø 65	M14	0,35	BKTSM65	●	1
Ø 65	M14	0,5	BKTSM66	●	1
Ø 75	M14	0,35	BKTSM75	●	1
Ø 80	M14	0,35	BKTSM80	●	1
Ø 80	M14	0,5	BKTSM81	●	1
Ø 100	M14	0,35	BKTSM100	●	1
Ø 100	M14	0,5	BKTSM101	●	1

CUP BRUSHES

M14



CUP BRUSH STEEL 22.2 KNOTTED WIRE

diameter	centre hole	wire thickness	code	stock	
Ø 80	22,2	0,35	BK TSA80	●	1
Ø 80	22,2	0,5	BK TSA81	●	1

CUP BRUSHES

WITH CENTRE HOLE



● = available from stock

● = available in 5 working days

● = on request

Steel wire brushes

M14

BEVEL BRUSHES

BEVEL BRUSH STEEL M14 CRIMPED WIRE



diameter	attach- ment	wire thickness	code	max RPM	stock	
Ø 100	M14	0,3	BSRSM100	12.500	●	1

M14

BEVEL BRUSHES

BEVEL BRUSH STEEL M14 KNOTTED WIRE



diameter	attach- ment	wire thickness	code	max RPM	stock	
Ø 100	M14	0,5	BSTSM100	12.500	●	1
Ø 115	M14	0,5	BSTSM115	12.500	●	1

HAND BRUSHES

HAND BRUSH STEEL CRIMPED WIRE



rows	shape	length	wire thickness	wire length	code	stock	
1	┐	140	0,3	25	BHS1R	●	5
2	┌┐	145	0,35	25	BHS2R	●	12
3	┌┌┌	145	0,35	25	BHS3R	●	12
4	┌┌┌┌	145	0,35	25	BHS4R	●	12
3	┐	145	0,35	35	BHS3V	●	12



For other references, please consult Cibo.

➤ Stainless steel wire brushes

WHEEL BRUSH STAINLESS STEEL CRIMPED WIRE

diameter	width	centre hole	wire thickness	wire length	code	stock	
Ø 100	20	20	0,2	23	BRIA10020*	●	1
Ø 125	22	20	0,3	30	BRIA12522*	●	1
Ø 150	30	31,75	0,3	29	BRIA15030**	●	1
	30	31,75	0,2	29	BRIA15130**	●	1
Ø 178	32	31,75	0,3	38	BRIA17832**	●	1
	32	31,75	0,2	38	BRIA17932**	●	1
Ø 200	30	31,75	0,3	38	BRIA20030**	●	1
	30	31,75	0,2	38	BRIA20130**	●	1
Ø 250	28	50,8	0,3	47	BRIA25028***	●	1
	28	50,8	0,2	47	BRIA25128***	●	1

* These brushes are supplied with 1/2" and 5/8" reduction rings.

** These brushes are supplied with 13 mm, 15 mm, 16 mm, 19 mm, 20 mm, 7/8" and 1" reduction rings.

*** For these brushes, the desired shaft diameter is listed between 20 mm and 50.8 mm.

WHEEL BRUSHES

WITH CENTRE HOLE



WHEEL BRUSH STAINLESS STEEL CRIMPED WIRE SPINDLE MOUNTED

diameter	width	spindle diameter	wire thickness	wire length	code	stock	
Ø 40	11	6	0,2	10	BRIS4011	●	10
Ø 50	17	6	0,3	13	BRIS5017	●	10
Ø 60	18	6	0,3	15	BRIS6018	●	10
Ø 70	18	6	0,3	15	BRIS7018	●	10
Ø 80	19	6	0,3	20	BRIS8019	●	10
Ø 100	9	6	0,3	20	BRIS10009	●	5

WHEEL BRUSHES

SPINDLE MOUNTED



● = available from stock

● = available in 5 working days

● = on request

➤ Stainless steel wire brushes

SPINDLE MOUNTED

END BRUSHES



END BRUSH STAINLESS STEEL POINT CRIMPED WIRE

diameter	spindle diameter	wire thickness	wire length	code	max RPM	stock	
Ø 9,5	6	0,3	32	BRPIP8	12.000	●	1

SPINDLE MOUNTED

END BRUSHES



END BRUSH STAINLESS STEEL CRIMPED WIRE

diameter	spindle diameter	wire thickness	wire length	code	max RPM	stock	
Ø 17	6	0,3	25	BRIP17	18.000	●	12

SPINDLE MOUNTED

END BRUSHES



END BRUSH STAINLESS STEEL KNOTTED WIRE

diameter	spindle diameter	wire thickness	wire length	code	max RPM	stock	
Ø 20	6	0,26	29	BTIP20	22.000	●	12
Ø 23	6	0,26	29	BTIP23	20.000	●	12
	6	0,35	29	BTIP24	20.000	●	12
Ø 30	6	0,26	29	BTIP30	20.000	●	12
	6	0,35	29	BTIP31	20.000	●	12

➤ Stainless steel wire brushes

CUP BRUSH STAINLESS STEEL M14 CRIMPED WIRE

diameter	attach- ment	wire thickness	code	max RPM	stock	
Ø 60	M14	0,3	BKRIM60	12.500	●	1
Ø 75	M14	0,3	BKRIM75	12.500	●	1
Ø 80	M14	0,3	BKRIM80	8.500	●	1
Ø 100	M14	0,3	BKRIM100	8.500	●	1
Ø 125	M14	0,3	BKRIM125	6.500	●	1

CUP BRUSHES

M14



CUP BRUSH STAINLESS STEEL M14 KNOTTED WIRE

diameter	attach- ment	wire thickness	code	max RPM	stock	
Ø 65	M14	0,35	BKTIM65	12.500	●	1
Ø 80	M14	0,35	BKTIM80*	8.500	●	1
Ø 80	M14	0,5	BKTIM81*	8.500	●	1
Ø 100	M14	0,35	BKTIM100*	8.500	●	1

CUP BRUSHES

M14



* with removable ring

HAND BRUSH STAINLESS STEEL STRAIGHT WIRE

rows	shape	length	wire thickness	wire length	code	stock	
1	┌	140	0,3	25	BHI1R	●	5
2	┌┌	145	0,35	25	BHI2R	●	12
3	┌┌┌	145	0,35	25	BHI4R	●	12
3	└	145	0,35	35	BHI3V	●	12

HAND BRUSHES



For other references, please consult Cibo.

● = available from stock

● = available in 5 working days

● = on request

➤ Grittyflex brushes

SPINDLE MOUNTED

WHEEL BRUSHES



GRITTYFLEX WHEEL BRUSH SPINDLE MOUNTED

diameter	spindle diameter	grit	code	colour	max RPM	stock	
Ø 75	6	80	BRSMS8075	red	4.500	●	1
	6	180	BRSMS18075	blue	4.500	●	1
Ø 100	6	80	BRSMS80100	red	4.500	●	1
	6	180	BRSMS180100	blue	4.500	●	1

SPINDLE MOUNTED

END BRUSHES



GRITTYFLEX END BRUSH SPINDLE MOUNTED

diameter	spindle diameter	grit	code	colour	max RPM	stock	
Ø 25	6	80	BPSMS8025	red	20.000	●	1
Ø 25	6	180	BPSMS18025	blue	20.000	●	1

SPINDLE MOUNTED

CUP BRUSHES



GRITTYFLEX CUP BRUSH SPINDLE MOUNTED

diameter	spindle diameter	grit	code	colour	max RPM	stock	
Ø 50	6	80	BKSMS8050	red	4.500	●	1
	6	180	BKSMS18050	blue	4.500	●	1
Ø 75	6	80	BKSMS8075	red	4.500	●	1
	6	180	BKSMS18075	blue	4.500	●	1

➤ Schmilon brushes

SCHMILON WHEEL BRUSH

diameter	width	centre hole		grit	code	stock	📦
		min.	max.				
Ø 100	18	13	20	80	BRSMA80100/./	●	1
Ø 150	18	13	32	120	BRSMA120150/./	●	2
Ø 200	18	19	40	120	BRSMA120200/./	●	1
Ø 250	18	20	40	80	BRSMA80250/./	●	2
	20	20	40	120	BRSMA120250/./	●	2

Please replace /... / with the required shaft opening in the order.

WHEEL BRUSHES

WITH CENTRE HOLE



SCHMILON TUBE BRUSH

diameter	schmilon height	spindle diameter	total length	grit	code	stock	📦
Ø 10	50	4	125	80	BBSMS8010	●	12
	50	4	125	120	BBSMS12010	●	12
Ø 13	50	4	125	80	BBSMS8013	●	12
	50	4	125	120	BBSMS12013	●	12
Ø 16	50	5	125	80	BBSMS8016	●	12
	50	5	125	120	BBSMS12016	●	12
Ø 19	65	5	125	80	BBSMS8019	●	12
	65	5	125	120	BBSMS12019	●	12
Ø 32	65	6	125	80	BBSMS8032	●	12
	65	6	125	120	BBSMS12032	●	12

TUBE BRUSHES

SPINDLE MOUNTED



● = available from stock

● = available in 5 working days

● = on request

REDUCTION RINGS



➤ Reduction rings

NYLON

exterior-diameter	interior-diameter	code	stock	
Ø 31,75	Ø 13	RSS31130	●	2
Ø 31,75	Ø 15	RSS31150	●	2
Ø 31,75	Ø 16	RSS31160	●	2
Ø 31,75	Ø 19	RSS31190	●	2
Ø 31,75	Ø 20	RSS31200	●	2
Ø 31,75	Ø 22,2	RSS31222	●	2
Ø 31,75	Ø 25,4	RSS31254	●	2
Ø 20	Ø 12,7	RSS20130	●	2
Ø 20	Ø 15,8	RSS20160	●	2



For other references, please consult Cibo.

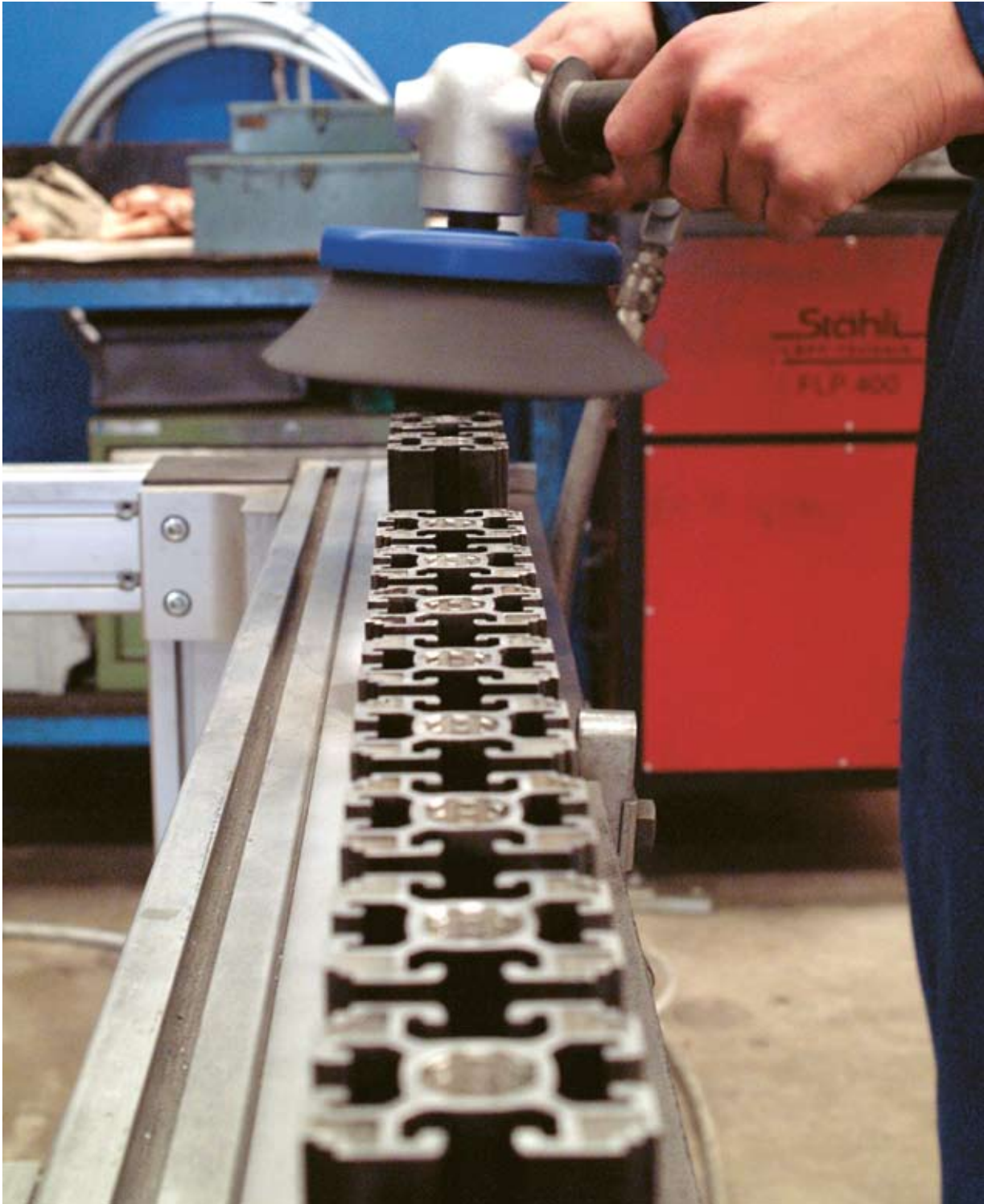

● = available from stock

● = available in 5 working days

● = on request

HARD METAL BURRS

- Cylinder 412
- Cylinder + end cut 413
- Bull nose 413
- Ball 414
- Oval 414
- Round tree 415
- Pointed tree 415
- Flame 416
- Counter sink 60° - 90° 416
- Ball nosed cone 417
- Cone 417



HARD METAL BURRS



The increased pressure in a contemporary, demanding working environment often confronts us with unforeseen technical problems and challenges. This is the reason why Cibo only works with 100% hard metal burrs, using the motto "Only the best is good enough".

We are therefore always ready to help you select the most suitable burrs. Together with Procut, Cibo sees itself as your partner in finding the ideal solution for all your deburring problems. Other shapes and tothing are available.



TOOTHING 3 IS MOST SUITABLE FOR:

- Aluminium
- Soft non-ferrous metals
- Copper, brass, bronze
- Toughened plastics
- Fibreglass with low density



TOOTHING 6 IS MOST SUITED FOR :

- Carbon Steel
- Cast iron
- Tooling steel
- Stainless steel
- Titanium and cobalt alloys
- Composite materials
- High density fibreglass

> Burrs

CYLINDER (A)

CYLINDER (A)



A

diameter burr	tooth-ing	useful length	spindle diameter	total length	code	stock	
Ø 3,0	6	14,0	Ø 3	38	HMFA30314/6	●	1
Ø 6,0	6	18,0	Ø 6	50	HMFA60618/6	●	1
Ø 8,0	6	19,2	Ø 6	64	HMFA60820/6	●	1
Ø 9,6	3	19,2	Ø 6	64	HMFA61020/3	●	1
Ø 9,6	6	19,2	Ø 6	64	HMFA61020/6	●	1
Ø 12,5	6	19,2	Ø 6	64	HMFA61220/6	●	1
Ø 12,5	3	25,4	Ø 6	70	HMFA61225/3	●	1
Ø 12,5	6	25,4	Ø 6	70	HMFA61225/6	●	1
Ø 15,8	3	25,4	Ø 6	70	HMFA61525/3*	●	1
Ø 15,8	6	25,4	Ø 6	70	HMFA61525/6*	●	1

** Also available with 8mm spindle.*



For other dimensions and tothing, please consult Cibo.

> Burrs

CYLINDER + END CUT (B)

diameter burr	tooth-ing	useful length	spindle diameter	total length	code	stock	
Ø 3,0	6	14,0	Ø 3	38	HMFB30314/6	●	1
Ø 6,0	6	18,0	Ø 6	50	HMFB60618/6	●	1
Ø 8,0	6	19,2	Ø 6	64	HMFB60820/6	●	1
Ø 9,6	3	19,2	Ø 6	64	HMFB61020/3	●	1
Ø 9,6	6	19,2	Ø 6	64	HMFB61020/6	●	1
Ø 12,5	6	19,2	Ø 6	64	HMFB61220/6	●	1
Ø 12,5	6	25,4	Ø 6	70	HMFB61225/6*	●	1
Ø 15,8	6	25,4	Ø 6	70	HMFB61525/6*	●	1
Ø 15,8	6	25,4	Ø 8	70	HMFB81525/6	●	1

* Also available with 8mm spindle.

CYLINDER + END CUT (B)



B

BULL NOSE (C)

diameter burr	tooth-ing	useful length	spindle diameter	total length	code	stock	
Ø 3,0	6	14,0	Ø 3	38	HMFC30312/6	●	1
Ø 6,35	6	12,7	Ø 3	51	HMFC30612/6	●	1
Ø 6,0	6	18,0	Ø 6	50	HMFC60618/6	●	1
Ø 8,0	6	19,2	Ø 6	64	HMFC60820/6	●	1
Ø 9,6	3	19,2	Ø 6	64	HMFC61020/3	●	1
Ø 9,6	6	19,2	Ø 6	64	HMFC61020/6	●	1
Ø 12,5	6	19,2	Ø 6	64	HMFC61220/6	●	1
Ø 12,5	3	25,4	Ø 6	70	HMFC61225/3*	●	1
Ø 15,8	6	25,4	Ø 6	70	HMFC61525/6*	●	1
Ø 15,8	6	25,4	Ø 8	70	HMFC81525/6	●	1

* Also available with 8mm spindle.

BULL NOSE (C)



C

● = available from stock

● = available in 5 working days

● = on request

> Burrs

BALL (D)



BALL (D)

diameter burr	tooth-ing	useful length	spindle diameter	total length	code	stock	
Ø 3,0	6	2,7	Ø 3	38	HMFD30303/6	●	1
Ø 6,35	6	5,7	Ø 3	45	HMFD30606/6	●	1
Ø 6,0	6	5,7	Ø 6	50	HMFD60606/6	●	1
Ø 8,0	6	7,0	Ø 6	52	HMFD60808/6	●	1
Ø 9,6	3	8,5	Ø 6	54	HMFD61010/3	●	1
Ø 9,6	6	8,5	Ø 6	54	HMFD61010/6	●	1
Ø 12,5	6	11,4	Ø 6	56	HMFD61212/6*	●	1
Ø 15,8	6	14,4	Ø 6	59	HMFD61515/6*	●	1
Ø 15,8	6	14,4	Ø 8	68	HMFD81515/6	●	1

* Also available with 8mm spindle.

OVAL (E)



OVAL (E)

diameter burr	tooth-ing	useful length	spindle diameter	total length	code	stock	
Ø 3,0	6	5,0	Ø 3	38	HMFE30306/6	●	1
Ø 6,0	6	10,0	Ø 6	50	HMFE60610/6	●	1
Ø 8,0	6	15,0	Ø 6	60	HMFE60815/6	●	1
Ø 9,6	6	15,8	Ø 6	60	HMFE61015/6	●	1
Ø 12,5	6	22,2	Ø 6	67	HMFE61220/6*	●	1
Ø 15,8	6	25,4	Ø 6	70	HMFE61525/6*	●	1
Ø 15,8	6	25,4	Ø 8	70	HMFE81525/6	●	1

* Also available with 8mm spindle.



For other dimensions and tothing, please consult Cibo.

> Burrs

ROUND TREE (F)

diameter burr	tooth-ing	useful length	spindle diameter	total length	code	stock	
Ø 3,0	6	14,0	Ø 3	38	HMFF30312/6	●	1
Ø 6,0	6	18,0	Ø 6	50	HMFF60618/6	●	1
Ø 8,0	6	20,0	Ø 6	65	HMFF60820/6	●	1
Ø 9,6	3	19,2	Ø 6	65	HMFF61020/3	●	1
Ø 9,6	6	19,2	Ø 6	65	HMFF61020/6	●	1
Ø 12,5	6	19,2	Ø 6	70	HMFF61220/6	●	1
Ø 12,5	3	25,4	Ø 6	70	HMFF61225/3*	●	1
Ø 12,5	6	25,4	Ø 6	70	HMFF61225/6*	●	1
Ø 15,8	6	25,4	Ø 6	70	HMFF61525/6*	●	1

* Also available with 8mm spindle.

ROUND TREE (F)



F

POINTED TREE (G)

diameter burr	tooth-ing	useful length	spindle diameter	total length	code	stock	
Ø 6,35	6	12,7	Ø 3	51	HMFG30612/6	●	1
Ø 6,0	6	18,0	Ø 6	60	HMFG60618/6	●	1
Ø 8,0	6	19,2	Ø 6	65	HMFG60820/6	●	1
Ø 9,6	6	19,2	Ø 6	65	HMFG61020/6	●	1
Ø 12,5	6	19,2	Ø 6	65	HMFG61220/6	●	1
Ø 12,5	6	25,4	Ø 6	70	HMFG61225/6*	●	1
Ø 15,8	6	25,4	Ø 6	70	HMFG61525/6*	●	1
Ø 12,5	6	25,4	Ø 8	86	HMFG81225/6	●	1

* Also available with 8mm spindle.

POINTED TREE (G)



G

● = available from stock

● = available in 5 working days

● = on request

> Burrs

FLAME (H)



H

FLAME (H)

diameter burr	tooth-ing	useful length	spindle diameter	total length	code	stock	
Ø 3,0	6	6,0	Ø 3	38	HMFH30306/6	●	1
Ø 8,0	6	19,2	Ø 6	64	HMFH60820/6	●	1
Ø 12,5	6	31,8	Ø 6	77	HMFH61232/6*	●	1
Ø 15,8	6	36,5	Ø 6	82	HMFH61535/6*	●	1
Ø 12,5	6	31,8	Ø 8	86	HMFH81232/6	●	1

* Also available with 8mm spindle.

COUNTER SINK 60° - 90° (J/K)



J/K

COUNTER SINK 60° - 90° (J/K)

diameter burr	tooth-ing	useful length	spindle diameter	total length	code	stock	
Ø 12,5	6	10,8	Ø 6	59	HMFJ61210/6*	●	1
Ø 15,8	6	14,5	Ø 6	62	HMFJ61512/6*	●	1
Ø 9,6	6	4,3	Ø 6	53	HMFK61004/6	●	1
Ø 12,5	6	6,8	Ø 6	55	HMFK61206/6*	●	1
Ø 15,8	6	8,0	Ø 8	57	HMFK81508/6	●	1

* Also available with 8mm spindle.



> Burrs

BALL NOSED CONE (L)

diameter burr	tooth-ing	useful length	spindle diameter	total length	code	stock	
Ø 3,0	6	14,0	Ø 3	38	HMFL30312/6	●	1
Ø 6,0	6	18,0	Ø 6	50	HMFL60618/6	●	1
Ø 8,0	6	25,4	Ø 6	70	HMFL60822/6	●	1
Ø 9,6	6	30,2	Ø 6	75	HMFL61026/6	●	1
Ø 12,5	6	32,0	Ø 6	77	HMFL61228/6*	●	1
Ø 15,8	6	33,3	Ø 6	78	HMFL61533/6*	●	1
Ø 12,5	6	32	Ø 8	86	HMFL81228/6	●	1

* Also available with 8mm spindle.

BALL NOSED CONE (L)



L

CONE (M)

diameter burr	tooth-ing	useful length	spindle diameter	total length	code	stock	
Ø 3,0	6	15,0	Ø 3	38	HMFM30315/6	●	1
Ø 6,0	6	20,0	Ø 6	58	HMFM60620/6	●	1
Ø 9,6	6	19,2	Ø 6	64	HMFM61020/6	●	1
Ø 12,5	6	25,4	Ø 6	70	HMFM61222/6*	●	1

* Also available with 8mm spindle.

CONE (M)



M



For other dimensions and tothing, please consult Cibo.



● = available from stock

● = available in 5 working days

● = on request

MACHINES

● Finitube	421
○ Accessories	426
● Finit-Easy	429
○ Accessories	436
● Finimaster Pro	439
○ Accessories	444
● Finimaster Basic	448
○ Accessories	450
● Finipower	456
● Inline grinder	456
● Pipetuner	458
○ Accessories	459
● Polishing mills	460
● Finiflex	461
○ Accessories	461

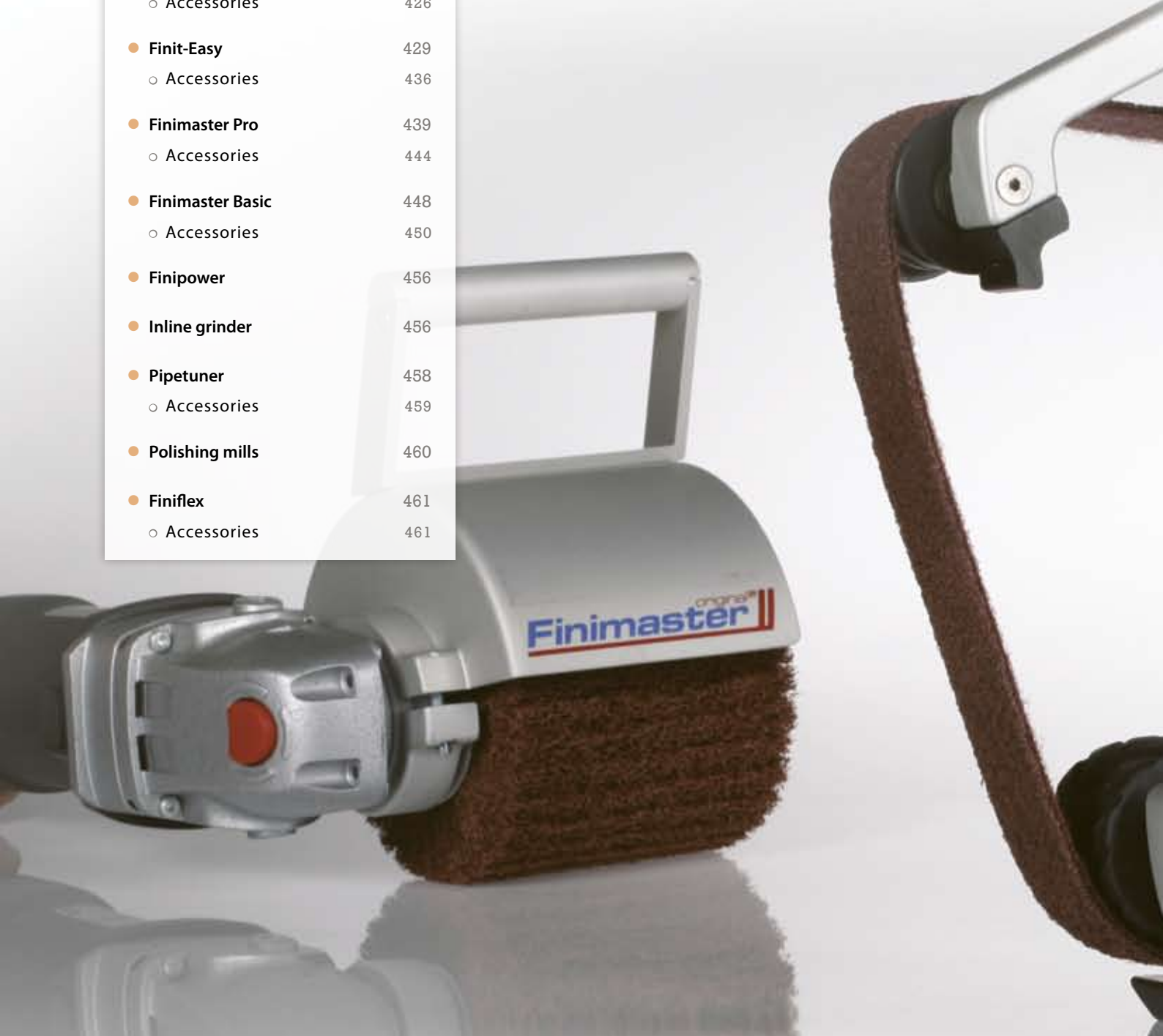

MACHINES





Finitube original

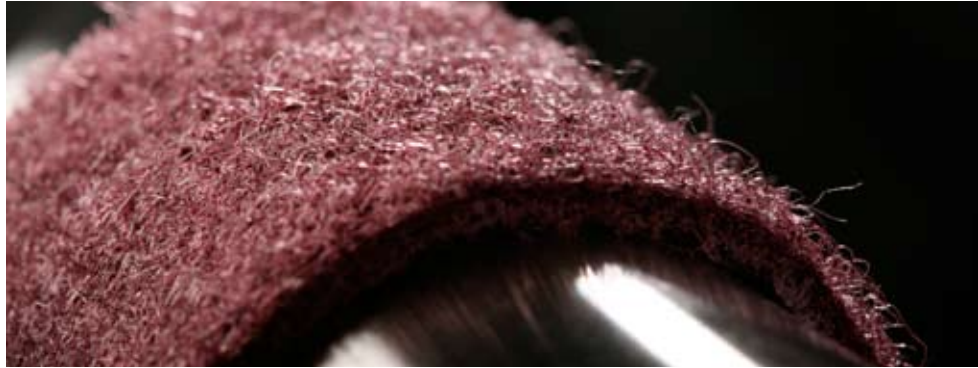

➤ **Finitube, the powerful and versatile finishing champion.**

There are many types of tube fabrication. Tight radius bends, wide sweeping curves or simple long lengths. Whatever the type of tube or pipe you need to finish, achieving a consistent high quality finish is always the challenge.

The new Finitube is an innovative and ingeniously designed tool for the easy finishing of tube and pipes. This is a trail-blazing concept. In the design, Cibo has combined the experience of the many regular and satisfied users of the first model with the know-how and expertise of Cibo engineers. The result: a harmonious marriage between user-friendliness, innovative design and industrial quality, guaranteeing a quick and perfect finish for any type of tube, cylinder or pipe construction.

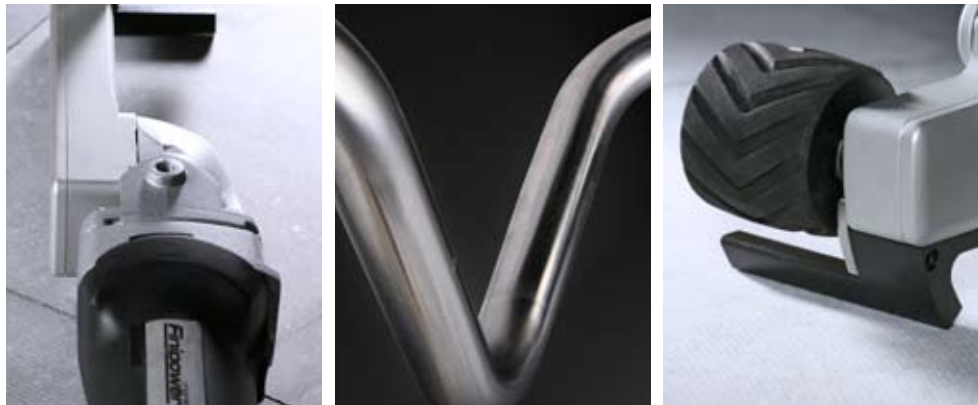

> THE DETAILS

UNIQUE DRIVE

The directly driven arm on the driving motor is a remarkable technical improvement of the new Finitube. It is truly unique. This direct drive makes the connection between both parts extremely compact and stable. The abrasive belt is located in the extension of the machine and is perfectly aligned with the drive motor. As a result, the belt is very stable and runs smoothly over any tube or cylinder. Due to this unique design, the machine is very compact and easy to use.



BELT GUIDE

The new Finitube's 3 guide wheels immediately attract attention. Each wheel has its own design and technical properties. Each tread has its own pattern. The two runner wheels are wear-resistant and break-resistant and are equipped with specially designed lateral flanges. The rubber driving wheel comes with smart V-grooves. This unique concept gives the user many advantages. First of all, there is the incredibly flexible and stable belt tracking. The innovative guide wheels make it practically impossible for the machine's abrasive belt to slip off, irrespective of the machine's or user's position or complexity of the tube to be worked. The V-grooves ensure perfect traction without slipping and cool operation that considerably extends the lifespan of your abrasive belts.

EXTENSION ARM

The extension arm has an impact-proof foot. As a result, it is safe to place the machine on the floor even while the belt is turning, which increases user-friendliness. A protective stop has been mounted on the arm. This is the key to worry-free use of the machine, as it protects the workpieces against possible damage by the machine. The arm itself has been designed to be opened simply and quickly.





ROUND HANDLE

The unique round handle on the Finitube's top arm is extremely easy to operate, regardless of the operator's position. Due to the ingenious position of this round handle, less strength is required to close the arm completely. This allows the user to grip practically any tube, regardless of its diameter, to give it an optimal finish.



270°

With the most frequently used tube diameters, you have an immediate reach of no less than 270°, and with an extra movement, you can easily reach the full 360°.

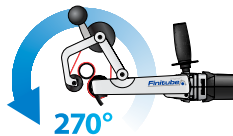
**THE MULTI V-BELT**

The powerful 1200 Watt driving motor has a double gear transmission with an extremely high torque. In order to transmit this force to the abrasive belt, a practically indestructible Multi V-belt is used with a built-in slip clutch. Because this drive will slip before the machine reaches its highest torque point, it retains its ability to protect the motor and the operator.



➤ Finitube

FINITUBE SET

code	voltage	power	stock	
SMFTNA	220V	1200W	●	1
SMFTNB	110V	1200W	●	1

content	code	description	number
	–	Motor and FiniTube-arm	1
	VT/RC1/675X40	Reinforced Tex belt 675x40 RC1-Coarse	1
	VT/RC2/675X40	Reinforced Tex belt 675x40 RC2-Medium	2
	VT/RC3/675X40	Reinforced Tex belt 675x40 RC3-Fine	1
	JF4T/120/675X40	Abrasive belt 675x40 grit type 120	2
	JF4T/220/675X40	Abrasive belt 675x40 grit type 220	2
	JF4T/320/675X40	Abrasive belt 675x40 grit type 320	2
	237AA/30/675X40	Trizact™belt 675x40 grit type A30 (= grit type P600)	1
	237AA/45/675X40	Trizact™belt 675x40 grit type A45 (= grit type P400)	1
	MFx/240/675X40	Micro Finish belt 675x40 grit type 240 (= grit type P1200)	1
	MFx/320/675X40	Micro Finish belt 675x40 grit type 320 (= grit type P1500)	1
	T/AVFSOFT/170158	Tex sheet 170 x 158 AvfSoft-Very fine	4
	T/SUF1000/170158	Tex sheet 170 x 158 Suf1000-Ultra fine	4
	FORU/60	Rubber-bonded sanding block grit type 60	1
	SPIC	Inoxiclean spray can	1

+ delivered in a sturdy box

Trizact™ is a registered trademark of the 3M Company.

FINITUBE



● = available from stock

● = available in 5 working days

● = on request

➤ Cloth Finitube belts

JF4T - A/O



dimensions	grit	code	stock	
675x40	60	JF4T/60/675x40B	●	10
	80	JF4T/80/675x40B	●	10
	120	JF4T/120/675x40B	●	10
	150	JF4T/150/675x40B	●	10
	180	JF4T/180/675x40B	●	10
	220	JF4T/220/675x40B	●	10
	320	JF4T/320/675x40B	●	10
	400	JF4T/400/675x40B	●	10

TZ59 - ZIRC.



dimensions	grit	code	stock	
675x40	40	TZ59/40/675x40B	●	10
	60	TZ59/60/675x40B	●	10
	80	TZ59/80/675x40B	●	10
	100	TZ59/100/675x40B	●	10
	120	TZ59/120/675x40B	●	10

237AA - TRIZACT™



dimensions	grit	code	stock	
675x40	A6 (P2000)	237AA/6/675x40B	●	10
	A16 (P1400)	237AA/16/675x40B	●	10
	A30 (P600)	237AA/30/675x40B	●	10
	A45 (P400)	237AA/45/675x40B	●	10
	A65 (P280)	237AA/65/675x40B	●	10
	A80 (P240)	237AA/80/675x40B	●	10
	A100 (P220)	237AA/100/675x40B	●	10
	A160 (P120)	237AA/160/675x40B	●	10

Trizact™ is a registered trademark of the 3M Company.

337DC - TRIZACT™

dimensions	grit	code	stock	
675x40	A65 (P280)	337DC/65/675x40B	●	10
	A100 (P220)	337DC/100/675x40B	●	10
	A300 (P80)	337DC/300/675x40B	●	10

**MFX - MICRO-MESH**

dimensions	grit	code	stock	
675x40	MX180 (P600)	MFX/180/675x40TB	●	10
	MX240 (P1200)	MFX/240/675x40TB	●	10
	MX320 (P1500)	MFX/320/675x40TB	●	10
	MX400 (P3000)	MFX/400/675x40TB	●	10
	MX600 (P3500)	MFX/600/675x40TB	●	10
	MX800 (P4000)	MFX/800/675x40TB	●	10
	MX1200 (P6000)	MFX/1200/675x40TB	●	10

**➤ Reinforced Tex Finitube belts****RC**

dimensions	grit	code	stock	
675x40	CO	VT/RC1/675x40TB	●	10
	ME	VT/RC2/675x40TB	●	10
	VF	VT/RC3/675x40TB	●	10

**T00 - POLISHING BELT**

dimensions	grit	code	stock	
675x40	T00	VT/T00/675x40TB	●	10



● = available from stock

● = available in 5 working days

● = on request



➤ **Finit-Easy,
no corner is safe any more!**



Accessibility is an important term in the world of abrasives. Nearly anything can be manufactured and welded, but it is not much help if the piece cannot be finished. The Finit-Easy offers you the accessibility and freedom of movement you require for a professional finish in hard-to-reach areas and corners. Finishing inside corners and removing weld seams becomes child's play with this innovative extension arm.



➤ THE DETAILS



UNIQUE DRIVE

The Cibo Finit-Easy has a direct connection of the arm to the drive motor. Due to this direct mounting, the connection between both parts is extremely compact and stable. The direct drive ensures the flexible and quiet working of the appliance. The device has ergonomic advantages. Due to the ingenious positioning of the arm, the device is better balanced, which improves its grip. This results in a smooth and comfortable operation.



ACCESSIBILITY

As the extension arm is connected onto the driving motor, the Finit-Easy is 40% more compact at the height of the connection, considerably increasing accessibility. At 25mm, the end of the arm is the narrowest on the market. As a result, the Finit-Easy can be used to finish acute corners up to 30°.

ADJUSTABLE PROTECTIVE COVER

The Finit-Easy has a practically continuous variable protective cover. With its handy click and sliding system, the protective cover can be moved through an angle of 90°. As a result, the cap can be optimally positioned at any given time with little effort, no matter how you twist or turn the machine. This ensures safe use in all circumstances, without the protective cap interfering with your work.

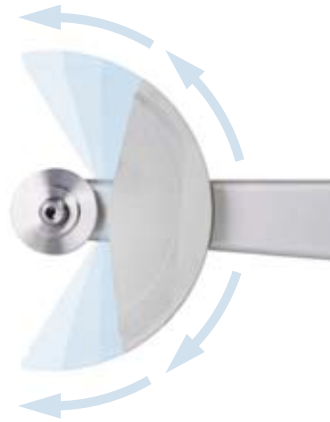

POWER AND DURABILITY

The powerful 1200 Watt drive motor has double gearing. It is a powerful motor, unstoppable even at low rpm. In order to transmit this power, a practically indestructible Multi V-belt with built-in slip clutch runs right through the extension arm. Because this drive belt will slip before the machine reaches its highest torque, it retains its ability to protect the motor and the operator. The rotation speed of the motor can be adjusted from 1300 to 4000 RPM. By adjustment of the speed of the machine to the advised RPM specified on the abrasive products, we can guarantee maximum efficiency of our abrasive material. In this way you can avoid burnt areas on the workpiece and you have maximum control of the grinding process.





STAINLESS STEEL-SAFE

The Finit-Easy extension arm is manufactured entirely from anodised aluminium. The flanges used to attach grinding products to the M14 screw thread are made from stainless steel. This makes the machine completely stainless steel-safe. There is no contamination if part of the machine comes in contact with a stainless steel workpiece.

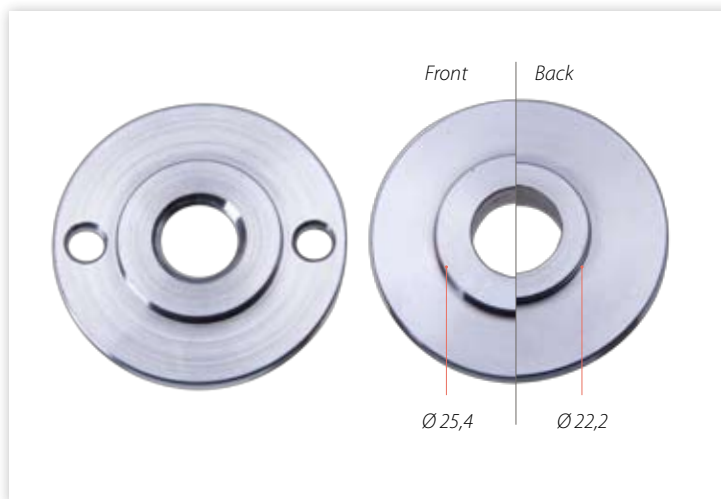

SMART FLANGES

The stainless steel flanges allow you to mount discs of varying shaft diameter and thickness effortlessly and safely on the Finit-Easy.

i *Stainless steel flanges: see p. 485*

> Finit-Easy

FINIT-EASY



FINIT-EASY SET

code	voltage	power	stock	
SMFEFA	220V	1200W	●	1
SMFEFB	110V	1200W	●	1
SMFEBA	220V	1200W	●	1
SMFEBB	110V	1200W	●	1



content	code	description	Number	
			SMFEBA	SMFEFA
-		FinPower®: 1200 Watt and Finit-Easy-arm	1	1
	SA2T31	Finishing wheel Ø150 x 6 x 25,4 SA2	-	1
	SA3T31	Finishing wheel Ø150 x 6 x 25,4 SA3	-	1
	SA5T31	Finishing wheel Ø150 x 6 x 25,4 SA5	1	1
	SA6T31	Finishing wheel Ø150 x 6 x 25,4 SA6	1	1
	SA7T31	Finishing wheel Ø150 x 6 x 25,4 SA7	1	1
	SA8T31	Finishing wheel Ø150 x 6 x 25,4 SA8	-	1
	SA7T30	Finishing wheel Ø150 x 3 x 25,4 SA7	1	1
	SA8T30	Finishing wheel Ø150 x 3 x 25,4 SA8	1	1
	SA10T30	Finishing wheel Ø150 x 3 x 25,4 SA10	-	1
	RCD/ME/125	RCD-disc Ø125x22 Medium	1	1
	SAG/5/125	SA-disc on glass fibre SA5 Ø125 x 22	1	1
	FORU/60	Rubber-bonded sanding block grit type 60	-	1
	SPIC	Inoxiclean spray can	-	1
	SV19030	Abrasive file 190 x 30mm	1	1
	706GR/24/V006	Grip sheet 190 x 30 mm Grit type 24	6	6

+ delivered in a sturdy box

+ socket wrench 4 mm and 6 mm + spanner



● = available from stock

● = available in 5 working days

● = on request

Finishing wheels

CONVOLUTE WHEELS SA



diameter	width	centre hole	density	code	stock	
150	6	25,4	SA1	SA1T31	●	6
	6	25,4	SA2	SA2T31	●	6
	6	25,4	SA3	SA3T31	●	6



For additional information : see p. 332

UNITIZED WHEELS SA



diameter	width	centre hole	density	code	advised TPM	max TPM	stock	
150	3	25,4	SA7	SA7T30	6000	3000	●	6
	3	25,4	SA8	SA8T30	6000	3000	●	6
	3	25,4	SA10	SA10T30	6000	3000	●	6
	6	25,4	SA5	SA5T31	6000	3000	●	6
	6	25,4	SA6	SA6T31	6000	3000	●	6
	6	25,4	SA7	SA7T31	6000	3000	●	6
	6	25,4	SA8	SA8T31	6000	3000	●	6
	6	25,4	SA10	SA10T31	6000	3000	●	6



For additional information : see p. 334

Felt wheels



FELT

diameter	width	centre hole	code	stock	
150	5	25,4	MHV5600/T31	●	6



➤ Grinding file with velcro backing

SV

dimensions	code	stock	
190x30	SV19030	●	1

➤ Paper grip sheets

SP706F

dimensions	code	stock	
190x30	706GR/24/V006	●	25



● = available from stock

● = available in 5 working days

● = on request



➤ **Finimaster Pro, the mobile workshop.**

This powerful machine with an extremely high torque ensures amazing power transmission. The adjustable speed guarantees comfort and is user-friendly. The ingeniously placed handle ensures 100% controllable working pressure.

The result is an uniform and flawless finish in less time and using less material on sheet material as well as on round and square tubes.

Regardless of whether we are dealing with satinising, structuring, homogenising, brushing, roughing, cleaning, polishing, ... the Finimaster combines high user-friendliness with a finish similar to that of a stationary machine. The Finimaster's great zest for work can be seen in the wide variety of brushes, belts and finishing and grinding wheels that can be used on this machine.



> THE DETAILS**APPLICATIONS**

Satinising, structuring, homogenising, brushing, roughing, cleaning, polishing, etc. of stainless steel, aluminium, brass, copper, plastic, wood and much more.





PROPERTIES

- Double toothed gear transmission that provides an extremely high torque, resulting in amazing power transmission.
- VTC-electronics steering guarantees a constant revolution speed. It monitors the winding temperature, even under heavy loads, and includes electronic safety restart.
- Continuously adjustable speed control from 900 to 2810 RPM for optimal use of the grinding products.
- Patented powder coating provides additional protection of the motor against dust (up 50% longer lifespan).
- Powerful 1200 Watt motor
- Double bearing
- The handle is placed directly above the grinding wheel for perfect control of the workpiece.
- Solid, easily adjustable protective cap.
- Each set is delivered with a sturdy toolbox.

BENEFITS

- Uniform & flawless finish
- Faster grinding, quicker results
- Perfect control of workpiece
- Suited for working sheet material as well as round and square tubes
- It is also possible to grind right into corners
- Grinding from practically any position thanks to the ingeniously adjustable protective cap.
- Faster change of materials thanks to the handy attachment system M14
- Cooler grinding
- Up 220% more grinding material



Finimaster Pro

FINIMASTER PRO SET

code	voltage	power	description	stock	
FMC1	220V	1200W	Finimaster Pro set	●	1
FMCIPRS1	220V	1200W	Finimaster Pro set 1	●	1
FMCIPRS2	220V	1200W	Finimaster Pro set 2	●	1
FMCIPRS1/110	110V	1200W	Finimaster Pro set 1 (110V)	●	1
FMCIPRS2/110	110V	1200W	Finimaster Pro set 2 (110V)	●	1

FINIMASTER PRO



content	code	description	Number	
			FMCIPRS1	FMCIPRS2
	FMC1	Finimaster machine	1	1
	FMTM/80/120110	Tex wheel Ø120 x 110 mm grit 80	1	1
	FCCM/80/120110	Combi wheel Ø120 x 110 mm grit 80	–	1
	FMSBM1	Drive wheel for abrasive belts	1	1
	FMNUM	Inflatable wheel Ø120 x 100 mm	1	1
	VT/FE1/395X100	Reinforced Tex sleeve Ø120 x 100 mm Coarse	1	1
	VT/FE2/395X100	Reinforced Tex sleeve Ø120 x 100 mm Medium	2	2
	VT/FE3/395X100	Reinforced Tex sleeve Ø120 x 100 mm Very Fine	1	1
	TZ59/40/385X100	Abrasive sleeve Ø120 x 100mm grit type 40	1	1
	TZ59/80/385X100	Abrasive sleeve Ø120 x 100mm grit type 80	1	1
	TZ59/120/385X100	Abrasive sleeve Ø120 x 100mm grit type 120	1	1
	337DC/300/385X100	Trizact™ sleeve Ø120 x 100 mm grit type 300 (= grit type P80)	2	2
	JF4T/80/675X40	Abrasive belt 675 x 40mm grit type 80	1	1
	JF4T/120/675X40	Abrasive belt 675 x 40mm grit type 120	1	1
	FMGRT/AF/60040	Tex open belt 600x40 mm AF	2	2
	FMGRT/SUF/60040	Tex open belt 600x40 mm SUF	2	2
	FMGRSL50030	Grip lock (velcro fastner) 500 x 30 mm	1	1
	FORU/60	Rubber-bonded sanding block grit type 60	–	1
	SPIC	Inoxiclean spray can	–	1
	MHIT	Inoxitape	–	1

+ delivered in a sturdy box
+ spanner 17mm + pump

Trizact™ is a registered trademark of the 3M Company.



● = available from stock

● = available in 5 working days

● = on request

Tex flap wheels

FMTM



diameter	width	grit	code	attach-ment	stock	
120	50	80	FMTM/80/12050	M14	●	1
	50	180	FMTM/180/12050	M14	●	1
110	50	280	FMTM/280/12050	M14	●	1
	50	400	FMTM/400/12050	M14	●	1
	50	600	FMTM/600/12050	M14	●	1
	50	CP	FMTM/CP/12050	M14	●	1
	110	80	FMTM/80/120110	M14	●	1
	110	180	FMTM/180/120110	M14	●	1
	110	280	FMTM/280/120110	M14	●	1
	110	400	FMTM/400/120110	M14	●	1
	110	600	FMTM/600/120110	M14	●	1
110	CP	FMTM/CP/120110	M14	●	1	

Combination flap wheels cloth/tex

FMCM



diameter	width	grit	code	attach-ment	stock	
120	50	80	FMCM/80/12050	M14	●	1
	50	180	FMCM/180/12050	M14	●	1
110	80	80	FMCM/80/120110	M14	●	1
	180	180	FMCM/180/120110	M14	●	1

Cotton polishing wheels

FMPM - SUM



diameter	width	attach-ment	type	code	stock	
125	110	M14	White cotton	FMPM125110	●	1
125	50	M14	White cotton	SUM12550	●	1

Flannel polishing wheels

FLM

diameter	width	attach-ment	type	code	stock	
125	50	M14	Flannel	FLM12550	●	1



Cloth sleeves for inflatable wheels (Ø120)

TZ59 - ZIRC.

dimensions	grit	code	stock	
385x100	40	TZ59/40/385x100B	●	10
	60	TZ59/60/385x100B	●	10
	80	TZ59/80/385x100B	●	10
	100	TZ59/100/385x100B	●	10
	120	TZ59/120/385x100B	●	10



Cloth sleeves for inflatable wheels (Ø120)

237AA - TRIZACT™

dimensions	grit	code	stock	
385x100	A160 (P120)	237AA/160/385x100B	●	10
	A100 (P220)	237AA/100/385x100B	●	10
	A80 (P240)	237AA/80/385x100B	●	10
	A65 (P280)	237AA/65/385x100B	●	10
	A45 (P400)	237AA/45/385x100B	●	10
	A30 (P600)	237AA/30/385x100B	●	10
	A16 (P1400)	237AA/16/385x100B	●	10
	A6 (P2000)	237AA/6/385x100B	●	10



Trizact™ is a registered trademark of the 3M Company.

● = available from stock

● = available in 5 working days

● = on request

➤ Cloth sleeves for inflatable wheels (Ø120)



337DC - TRIZACT™

dimensions	grit	code	stock	
385x100	A300 (P80)	337DC/300/385x100B	●	10
	A160 (P120)	337DC/160/385x100B	●	10
	A100 (P220)	337DC/100/385x100B	●	10
	A65 (P280)	337DC/65/385x100B	●	10
	A45 (P400)	337DC/45/385x100B	●	10

➤ Surface conditioning sleeves for inflatable wheels (Ø120)



FE

dimensions	grit	code	stock	
395x100	CO	VT/FE1/395x100TB	●	10
	ME	VT/FE2/395x100TB	●	10
	VF	VT/FE3/395x100TB	●	10

➤ Open cloth belts with velcro



TJ7 - A/O

dimensions	grit	code	stock	
600x40	60	FMGRL/60/60040	●	10
	80	FMGRL/80/60040	●	10
	100	FMGRL/100/60040	●	10
	120	FMGRL/120/60040	●	10
	220	FMGRL/220/60040	●	10
	320	FMGRL/320/60040	●	10

➤ Open tex belts with velcro



A/O - S/C

dimensions	grit	code	stock	
600x40	AF	FMGRT/AF/60040	●	10
	SUF600	FMGRT/SUF/60040	●	10

➤ Drive wheel for abrasive belts

FMSB

diameter	width	attachment	code	stock	
60	100	M14	FMSBM1	●	1



➤ FM keyway conversion spindle

FM KEYWAY CONVERSION SPINDLE

length	attachment	code	stock	
100	M14	FM AS+SPIE	●	1



➤ Inoxiclean

SPIC

Inhoud	code	stock	
400ml	SPIC	●	3



➤ Inoxitape

MHIT

length	width	thickness	code	stock	
5000	40	0,15	MHIT	●	1



➤ Inflatable wheel

FMNUM

diameter	width	attachment	code	stock	
120	100	M14	FMNUM	●	1



replacement rubber : see p. 468

● = available from stock

● = available in 5 working days

● = on request

> Finimaster

FINIMASTER



FINIMASTER BASIC

Applications: Satinising, structuring, homogenising, brushing, roughing, cleaning, polishing, etc. of stainless steel, aluminium, brass, copper, plastic, wood and much more.

code	voltage	power	description	stock	
FMBA	220V	1200W	Finimaster basic	●	1
FMBASET1	220V	1200W	Finimaster basic set 1	●	1
FMBASET2	220V	1200W	Finimaster basic set 2	●	1
FMBASET1/110	110V	1200W	Finimaster basic set 1 (110V)	●	1
FMBASET2/110	110V	1200W	Finimaster basic set 2 (110V)	●	1



FINIMASTER BASIC SET



content	code	description	Number	
			FMBASET1	FMBASET2
	FMBA	Finimaster Basic machine	1	1
	FMTA/80/100100	Tex wheel Ø100 x 100 mm grit type 80	1	1
	FMCA/80/100100	Combined wheel Ø100 x 100 mm grit type 80	–	1
	FMSB1	Drive wheel for abrasive belts	1	1
	FMNU374	Inflatable wheel Ø90 x 100 mm	1	1
	FMVT/FE1/305X100	Reinforced Tex sleeve Ø90 x 100 mm Coarse	1	1
	FMVT/FE2/305X100	Reinforced Tex sleeve Ø90 x 100 mm Medium	2	2
	FMVT/FE3/305X100	Reinforced Tex sleeve Ø90 x 100 mm Very Fine	1	1
	FMTZ59/40/293X100	Abrasive sleeve Ø90 x 100mm grit type 40	1	1
	FMTZ59/80/293X100	Abrasive sleeve Ø90 x 100mm grit type 80	1	1
	FMTZ59/120/293X100	Abrasive sleeve Ø90 x 100mm grit type 120	1	1
	337DC/300/293X100	Trizact™ sleeve Ø90 x 100mm grit type 300 (= grit type P80)	1	1
	JF4T/80/675X40	Abrasive belt 675 x 40mm grit type 80	1	1
	JF4T/120/675X40	Abrasive belt 675 x 40mm grit type 120	1	1
	FMGRT/AF/60040	Tex open belt 600x40 mm AF	2	2
	FMGRT/SUF/60040	Tex open belt 600x40 mm SUF	2	2
	FMGRSL50030	Grip lock (velcro fastner) 500 x 30 mm	1	1
	FORU/60	Rubber-bonded sanding block grit type 60	–	1
	SPIC	Inoxidean spray can	–	1
	MHIT	Inoxitape	–	1

+ delivered in a sturdybox
+ spanner 17mm + pump

Trizact™ is a registered trademark of the 3M Company.

● = available from stock

● = available in 5 working days

● = on request

➤ Cloth flap wheels

FMLA



diameter	width	grit	code	centre hole	stock	
100	100	24	FMLA/24/100100	19,6	●	1
	100	40	FMLA/40/100100	19,6	●	1
	100	60	FMLA/60/100100	19,6	●	1
	100	80	FMLA/80/100100	19,6	●	1
	100	120	FMLA/120/100100	19,6	●	1
	100	180	FMLA/180/100100	19,6	●	1
	100	220	FMLA/220/100100	19,6	●	1
	100	320	FMLA/320/100100	19,6	●	1
	100	400	FMLA/400/100100	19,6	●	1
	50	24	FMLA/24/10050	19,6	●	2
40		FMLA/40/10050	19,6	●	2	
60		FMLA/60/10050	19,6	●	2	
80		FMLA/80/10050	19,6	●	2	
120		FMLA/120/10050	19,6	●	2	
180		FMLA/180/10050	19,6	●	2	
220		FMLA/220/10050	19,6	●	2	
320		FMLA/320/10050	19,6	●	2	
400		FMLA/400/10050	19,6	●	2	

➤ Tex flap wheels

FMTA

diameter	width	grit	code	centre hole	stock	
100	100	80	FMTA/80/100100	19,6	●	1
	100	180	FMTA/180/100100	19,6	●	1
	100	280	FMTA/280/100100	19,6	●	1
	100	400	FMTA/400/100100	19,6	●	1
	100	600	FMTA/600/100100	19,6	●	1
	100	CP	FMTA/CP/100100	19,6	●	1
	50	80	FMTA/80/10050	19,6	●	2
	50	180	FMTA/180/10050	19,6	●	2
	50	280	FMTA/280/10050	19,6	●	2
	50	400	FMTA/400/10050	19,6	●	2
50	600	FMTA/600/10050	19,6	●	2	
50	CP	FMTA/CP/10050	19,6	●	2	



➤ CSD flap wheel

FMCS

diameter	width	grit	code	centre hole	stock	
100	100	CSD	FMCS100100	19,6	●	1



➤ Combination flap wheels cloth/tex

FMCA

diameter	width	grit	code	centre hole	stock	
100	100	80	FMCA/80/100100	19,6	●	1
	100	180	FMCA/180/100100	19,6	●	1
	50	80	FMCA/80/10050	19,6	●	2
	50	180	FMCA/180/10050	19,6	●	2



● = available from stock

● = available in 5 working days

● = on request

➤ Sisal polishing wheels



FMSS

diameter	width	grit	code	centre hole	stock	
100	100	Sisal	FMSS100100	19,6	●	1

➤ Cotton polishing wheels



FMPR

diameter	width	grit	code	centre hole	stock	
100	100	White Cotton	FMPR100100	19,6	●	1
	12	White Cotton	FMPR10012	19,6	●	8

➤ Felt polishing wheels



FMVR

diameter	width	grit	code	centre hole	stock	
100	50	Felt	FMVR10050	19,6	●	2

➤ Cloth sleeves for inflatable wheels (Ø90)



TZ59 - ZIRC.

dimensions	grit	code	stock	
293x100	40	FMTZ59/40/293x100	●	10
	60	FMTZ59/60/293x100	●	10
	80	FMTZ59/80/293x100	●	10
	100	FMTZ59/100/293x100	●	10
	120	FMTZ59/120/293x100	●	10

➤ Cloth sleeves for inflatable wheels (Ø90)

237AA - TRIZACT™

dimensions	grit	code	stock	
293x100	A160 (P120)	237AA/160/293x100B	●	10
	A100 (P220)	237AA/100/293x100B	●	10
	A80 (P240)	237AA/80/293x100B	●	10
	A65 (P280)	237AA/65/293x100B	●	10
	A45 (P400)	237AA/45/293x100B	●	10
	A30 (P600)	237AA/30/293x100B	●	10
	A16 (P1400)	237AA/16/293x100B	●	10
	A6 (P2000)	237AA/6/293x100B	●	10



337DC - TRIZACT™

dimensions	grit	code	stock	
293x100	A300 (P80)	337DC/300/293x100B	●	10
	A160 (P120)	337DC/160/293x100B	●	10
	A100 (P220)	337DC/100/293x100B	●	10
	A65 (P280)	337DC/65/293x100B	●	10
	A45 (P400)	337DC/45/293x100B	●	10



Trizact™ is a registered trademark of the 3M Company.

➤ Surface conditioning abrasive sleeves for inflatable wheels (Ø90)

FE

dimensions	grit	code	stock	
305x100	CO	FMVT/FE1/305x100	●	10
	ME	FMVT/FE2/305x100	●	10
	VF	FMVT/FE3/305x100	●	10



● = available from stock

● = available in 5 working days

● = on request

> Open cloth belts with velcro

TJ7 - A/O



dimensions	grit	code	stock	
600x40	60	FMGRL/60/60040	●	10
	80	FMGRL/80/60040	●	10
	100	FMGRL/100/60040	●	10
	120	FMGRL/120/60040	●	10
	220	FMGRL/220/60040	●	10
	320	FMGRL/320/60040	●	10

> Open tex belts with velcro

A/O - S/C



dimensions	grit	code	stock	
600x40	AF	FMGRT/AF/60040	●	10
	SUF600	FMGRT/SUF/60040	●	10

> Drive wheel for abrasive belts – with flanges

WITH FLANGES



diameter	width	code	stock	
60	100	FMSB2	●	1

> Drive wheel for abrasive belts – without flanges

WITHOUT FLANGES



diameter	width	code	stock	
60	100	FMSB1	●	1

FM keyway conversion spindle

FM KEYWAY CONVERSION SPINDLE

length	attachment	code	stock	
100	M14	FM AS+SPIE	●	1



Inoxiclean

SPIC

volume	code	stock	
400ml	SPIC	●	3



Inoxitape

MHIT

length	width	thickness	code	stock	
5000	40	0,15	MHIT	●	1



Inflatable wheel

FMNU

diameter	width	max RPM	code	centre hole	stock	
90	100	3200	FMNU374	19,6	●	1



replacement rubber : see p. 468

● = available from stock

● = available in 5 working days

● = on request

> Finipower

FINIPOWER



FINIPOWER

- Properties:**
- Motor protected against dust
 - Continuously adjustable rpm
 - Protection against overload
 - Spindle lock
 - Double-toothed gear transmission

code	voltage	power	RPM	stock	
SMFP	220V	1200W	900-2810	●	1
SMMS6A	220V	1200W	2000-6500	●	1

> Inline grinder

LINEAR GRINDER



INLINE GRINDER

- Properties & accessories :**
- Linear grinding machine 500 Watt
 - Standard delivery with a grinding arm and grip sole

code	voltage	power	RPM	stock	
SMFLSA	220V	500W	2300-5200	●	1

STRAIGHT ARM FOR INLINE GRINDER

code	stock	
SMSU908957	●	1

POINTED ARM FOR INLINE GRINDER

code	stock	
SMSU908958	●	1



● = available from stock

● = available in 5 working days

● = on request

▶ Tube notcher

PIPETUNER



PIPE TUNER

code	voltage	power	RPM	stock	
SMSP120/2	380V	4pk	1400-2800	●	1

DESCRIPTION

The Cibo "Dual Speed" Pipetuner is a powerful 4 hp machine capable of working all types of tubes, regardless of material, wall thickness or diameter. This Pipetuner has an adjustable belt speed (15 m/sec or 30 m/sec) and is capable of professionally and quickly grinding any angle between 30° and 90°, in preparation for welding. The Cibo Pipetuner: the logical choice for any professional.

BENEFITS

- Suitable for any wall thickness
- Suitable for any diameter
- Suitable for any type of material
- Faster grinding
- Low heat generation
- Burr-reducing grinding
- Less finishing
- Very precise finish

PROPERTIES & ACCESSORIES

- Extremely powerful 4hp motor for additional capacity
- Dust-free switch box with easily accessible emergency stop
- Two speeds: 1400 RPM or 15 m/sec and 2800 RPM or 30 m/sec
- Continuously variable adjustment of both the forward and lateral power supply.
- Fast and fixed attachment of the profiles using a professional bench vice
- Handy trimming table
- Quickly accessible
- Handy storage rack
- Simple belt replacement
- Quick replacement of contact rolls



➤ Contact rolls

CONTACT ROLLS – WITH BALL BEARING

diameter of tube to be ground	diameter contact roll	code	stock	
Ø 20	Ø 18,5	SMSP120/VCK/20	●	1
Ø 21,5	Ø 20	SMSP120/VCK/21.5	●	1
Ø 26,9	Ø 25,4	SMSP120/VCK/26.9	●	1
Ø 33,7	Ø 32,2	SMSP120/VCK/33.7	●	1
Ø 42,4	Ø 40,9	SMSP120/VCK/42.4	●	1
Ø 48,3	Ø 46,8	SMSP120/VCK/48.3	●	1
Ø 60,3	Ø 58,8	SMSP120/VCK/60.3	●	1
Ø 70	Ø 68,5	SMSP120/VCK/70	●	1
Ø 76,1	Ø 74,6	SMSP120/VCK/76.1	●	1
Ø 88,9	Ø 87,4	SMSP120/VCK/88.9	●	1
Ø 102	Ø 100,5	SMSP120/VCK/102	●	1



➤ Cloth belts

HG49T

Sizes	grit	code	stock	
2000x120	36	HG49T/36/2000x120B	●	10
2000x120	40	HG49T/40/2000x120B	●	10
2000x120	60	HG49T/60/2000x120B	●	10
2000x120	80	HG49T/80/2000x120B	●	10



● = available from stock

● = available in 5 working days

● = on request

Polishing mills

POLISHING MILL



POLISHING MILL LC 180 (INCLUDING BASE)

Properties: Cibo polishing mills are equipped with extra long attachment arms allowing you to mount polishing materials and brushes of various widths. In addition, Cibo offers a wide variety of reducing flanges, so that brushes and polishing materials with various shaft can be attached to the take-up shafts.

Version :

- Including base • 2 fixed protective covers Ø 400 mm with dust suction capability
- Thermal safety • Emergency stop

code	voltage	power	RPM	shaft length	diameter	stock	
SMLC18022M	220V mono	1800W	1400	210mm	Ø30	●	1
SMLC18022T	220V tri	1800W	1400-2800	210mm	Ø30	●	1
SMLC18038T	380V tri	1800W	1400-2800	210mm	Ø30	●	1

POLISHING MILL



POLISHING MILL LC 300 (INCLUDING BASE)

Properties: Cibo polishing mills are equipped with extra long attachment arms allowing you to mount polishing materials and brushes of various widths. In addition, Cibo offers a wide variety of reducing flanges, so that brushes and polishing materials with various shaft can be attached to the take-up shafts.

Version :

- Including base • 2 fixed protective covers Ø 430 mm with dust suction capability • Thermal safety • Emergency stop

code	voltage	power	RPM	shaft length	diameter	stock	
SMLC30038T	380V tri	3800W	700-1400	210mm	Ø30	●	1
SMLC30022T	220V tri	3800W	700-1400	210mm	Ø30	●	1



> Finiflex

BASIC SET

Properties: Ready for use. This machine consists of a drive motor, an industrial flexible shaft and a straight handle.

code	description	stock	
SMFN15CO	Set SMFN15 + SMFNA10 + SMFNRH10	●	1

FINIFLEX



> Basic motor

BASIC MOTOR

Properties:

- Strong, reliable induction motor of 1,500 Watt
- Can be used for all milling, grinding and polishing operations
- Variable settings from 500 to 15,000 RPM
- Maintains rpm despite load
- Can be used with different flexible shafts

code	description	stock	
SMFN15	Finiflex Master motor 1500 W (500 - 15.000 TPM)	●	1



> Flexible shafts

FLEXIBLE SHAFTS

code	description	stock	
SMFNA7	Flexible shaft Ø 7 mm x 1,5 m DIN 10/G 22	●	1
SMFNA10	Flexible shaft Ø 10 mm x 2 m DIN 10/G 28	●	1
SMFNA12	Flexible shaft Ø 12 mm x 2 m DIN 10/G 28	●	1



> Handles

HANDLES FOR SMFNA10

code	description	stock	
SMFNRH10	Straight handle for flexible shaft SMFNA10	●	1
SMFNHH10	Angle handle 90° for flexible shaft SMFNA10	●	1
SMFNHH10/45	Angle handle 45° for flexible shaft SMFNA10	●	1



● = available from stock

● = available in 5 working days

● = on request

➤ Handles

HANDLES FOR SMFNA7

code	description	stock	
SMFNRH7	Straight handle for flexible shaft SMFNA7	●	1
SMFNHH7	Angle handle 90° for flexible shaft SMFNA7	●	1
SMFNHH7/45	Angle handle 45° for flexible shaft SMFNA7	●	1



HANDLES FOR SMFNA12

code	description	stock	
SMFNRH12	Straight handle for flexible shaft SMFNA12	●	1





ACCESSORIES

- **Ventilated wheels** 466
- **Inflatable wheels** 467
- **Finimaster accessories** 468
- **Lockit®/Roloc® supports** 470
- **Socatt® supports** 471
- **Back-up pads for angle grinders** 472
- **Interlayer foam - heat-resistant** 473
- **Back-up pads for eccentric grinders** 474
- **Back-up pads for flexible shafts & drill machines** 475
- **Fibre back-up pads for angle grinder** 476
- **Shafts and spindles** 477
- **Reducing flanges** 482
- **Reducing rings** 484
- **Flanges for angle grinders** 485
- **Stainless steel flanges for Finit-Easy** 485
- **Mandrels** 486
- **Spira supports** 487
- **Hand sanding systems** 488
- **Spray glue** 489
- **Inoxiclean** 489
- **Inoxitape** 490
- **Wool felt** 491
- **Graphite cloth** 491
- **Drive belts for finishing machines** 491

Socatt®, Lockit® and Roloc® are brandnames of the 3M Company.



ACCESSORIES



> Ventilated wheels

VENTILATED WHEELS



VENTILATED WHEELS

Use: In combination with abrasive sleeves

diameter	width	centre hole	code	max RPM	stock	
Ø 90	50	30	V905030	6000	●	1
Ø 90	100	30	V9010030	6000	●	1
Ø 90	100	50	V9010050	6000	●	1
Ø 140	50	30	V1405030	4500	●	1
Ø 140	50	50	V1405050	4500	●	1
Ø 140	100	30	V14010030	4500	●	1
Ø 140	100	50	V14010050	4500	●	1
Ø 200	50	50	V2005050	2800	●	1
Ø 200	100	50	V20010050	2800	●	1



The abrasive sleeves are automatically clamped by the centrifugal force of the ventilated wheel.

➤ Inflatable wheels

NU-MATIC: FOR WORKING WOOD AND METALS

Use: In combination with abrasive sleeves

Properties :

- Inflatable wheel
- Determine the hardness of the contact yourself by inflating the wheel harder or softer

Applications : Woodwork and metalwork

diameter	width	attach- ment	code	max RPM	stock	
Ø 57	70	M14	NU223	9000	●	1
Ø 85	80	M14	NU331	7000	●	1
Ø 125	65	M14	NU525	4000	●	1
Ø 125	80	M14	NU534	4000	●	1

REPLACEMENT RUBBER

wheel	code	stock	
NU223	NU223/R	●	1
NU331	NU331/R	●	1
NU525	NU525/R	●	1
NU534	NU534/R	●	1

NU-MATIC



● = available from stock

● = available in 5 working days

● = on request

> Finimaster accessories

ADAPTER KEYWAY CONVERSION SPINDLE



ADAPTER KEYWAY CONVERSION SPINDLE

length	code	stock	
100	FM AS+SPIE	●	1

FINIMASTER PRO



FINIMASTER PRO - INFLATABLE WHEELS

diameter	width	attach-ment	code	stock	
Ø 120	100	M14	FMNUM	●	1

REPLACEMENT RUBBER

wheel	code	stock	
FMNUM	FMNUM/R	●	1

FINIMASTER BASIC



FINIMASTER BASIC - INFLATABLE WHEELS

diameter	width	centre hole	code	stock	
Ø 90	100	19,6	FMNU374	●	1

REPLACEMENT RUBBER

wheel	code	stock	
FMNU374	FMNU374/R	●	1

> Finimaster accessories

FINIMASTER PRO ABRASIVE BELT DRIVE - WITHOUT FLANGES

diameter	width	attach- ment	code	stock	
Ø 60	100	M14	FMSBM1	●	1

FINIMASTER PRO



FINIMASTER BASIC ABRASIVE BELT DRIVE - WITH FLANGES

diameter	width	centre hole	code	stock	
Ø 60	100	19,6	FMSB2	●	1

FINIMASTER BASIC



FINIMASTER BASIC ABRASIVE BELT DRIVE - WITHOUT FLANGES

diameter	width	centre hole	code	stock	
Ø 60	100	19,6	FMSB1	●	1

FINIMASTER BASIC



● = available from stock

● = available in 5 working days

● = on request

Lockit® / Roloc® supports

LOCKIT® / ROLOC®



LOCKIT® / ROLOC® HEAT-RESISTANT

diameter	density	spindle diameter	attach-ment	code	max RPM	stock	
Ø 25	medium	Ø 6	-	QLHO/M/256	40000	●	1
Ø 38	hard	Ø 6	-	QLHO/H/386	25000	●	1
Ø 38	medium	Ø 6	-	QLHO/M/386	25000	●	1
Ø 38	soft	Ø 6	-	QLHO/S/386	25000	●	1
Ø 50	hard	Ø 6	-	QLHO/H/506	25000	●	1
Ø 50	medium	Ø 6	-	QLHO/M/506	25000	●	1
Ø 50	soft	Ø 6	-	QLHO/S/506	25000	●	1
Ø 75	hard	Ø 6	-	QLHO/H/756	20000	●	1
Ø 75	medium	Ø 6	-	QLHO/M/756	20000	●	1
Ø 75	soft	Ø 6	-	QLHO/S/756	20000	●	1
Ø 50	medium	-	M14	QLRH/M/50M14	25000	●	1
Ø 75	medium	-	M14	QLRH/M/75M14	20000	●	1

Socatt®, Lockit® and Roloc® are brandnames of the 3M Company.

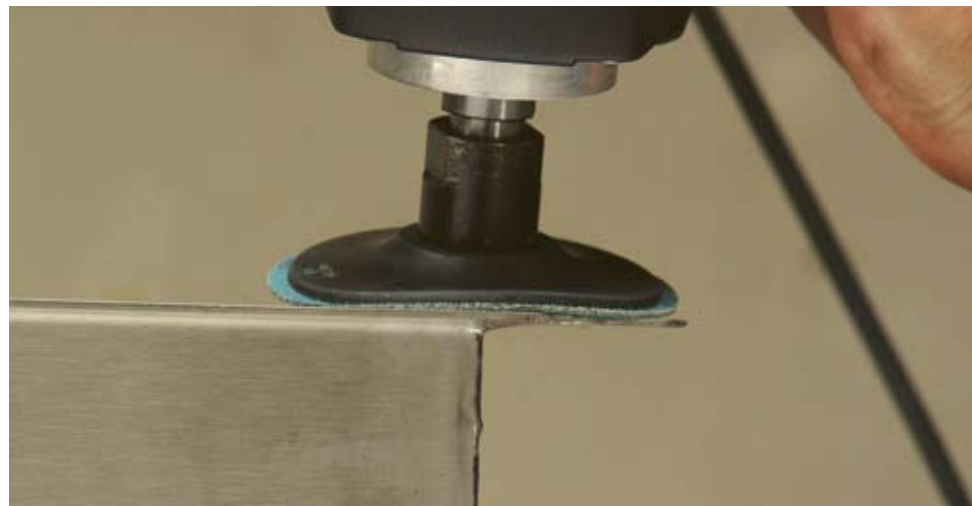

➤ Socatt® supports

SOCATT® HEAT-RESISTANT

diameter	density	spindle diameter	attach-ment	code	max RPM	stock	
Ø 19	medium	Ø 6	–	QSHO/M/196	40000	●	1
Ø 25	medium	Ø 6	–	QSHO/M/256	40000	●	1
Ø 38	hard	Ø 6	–	QSHO/H/386	25000	●	1
Ø 38	medium	Ø 6	–	QSHO/M/386	25000	●	1
Ø 38	soft	Ø 6	–	QSHO/S/386	25000	●	1
Ø 50	hard	Ø 6	–	QSHO/H/506	25000	●	1
Ø 50	medium	Ø 6	–	QSHO/M/506	25000	●	1
Ø 50	soft	Ø 6	–	QSHO/S/506	25000	●	1
Ø 75	hard	Ø 6	–	QSHO/H/756	20000	●	1
Ø 75	medium	Ø 6	–	QSHO/M/756	20000	●	1
Ø 75	soft	Ø 6	–	QSHO/S/756	20000	●	1
Ø 50	medium	–	M14	QSRH/M/50M14	25000	●	1
Ø 75	medium	–	M14	QSRH/M/75M14	25000	●	1
Ø 75	medium	–	M14	QSRH/M/75M14/MF*	25000	●	1

SOCATT®



* The Socatt® Miniflap, diameter of 75mm (see p. 304), only to be used in combination with this special back-up pad!



● = available from stock

● = available in 5 working days

● = on request

➤ Back-up pads for angle grinders

STANDARD - SEMI FLEXIBLE



STANDARD HOOK AND LOOP - SEMI-FLEXIBLE

diameter	thickness	attach-ment	code	stock	
Ø 115	16	M14	115VELSUPERXM	●	1
Ø 125	16	M14	125VELSUPERXM	●	1
Ø 125	16	5/8	125VELSUPER0-5/8	●	1
Ø 150	16	M14	150VELSUPERXM	●	1
Ø 178	16	M14	178VELSUPERXM	●	1
Ø 200	16	M14	200VELSUPERXM	●	1

STANDARD - HARD



STANDARD HOOK AND LOOP - HARD

diameter	thickness	attach-ment	code	stock	
Ø 115	5	M14	115VELNY	●	1
Ø 125	5	M14	125VELNY	●	1

STANDARD - HARD + 10MM FOAM



STANDARD HOOK AND LOOP - HARD + 10MM FOAM

diameter	thickness	attach-ment	code	stock	
Ø 115	15	M14	115VELNM	●	1

AX EXTRA - SEMI FLEXIBLE



AX EXTRA HOOK AND LOOP - SEMI-FLEXIBLE

diameter	thickness	attach-ment	code	stock	
Ø 115	16	M14	115AXSUPERXM	●	1
Ø 125	16	M14	125AXSUPERXM	●	1
Ø 150	16	M14	150AXSUPERXM	●	1
Ø 178	16	M14	178AXSUPERXM	●	1
Ø 200	16	M14	200AXSUPERXM	●	1

➤ Back-up pads for angle grinders

AX EXTRA HOOK AND LOOP - HARD

Applications : Suited for surface conditioning discs

diameter	thickness	attach- ment	code	stock	
Ø 115	8	M14	115VELSC	●	1
Ø 125	8	M14	125VELSC	●	1
Ø 178	8	M14	178VELSC	●	1

AX EXTRA - HARD



AX EXTRA HOOK AND LOOP - HARD WITH CENTRAL BUTTON

Applications : Exclusively suited for surface conditioning discs

Properties : Provided with a central button that ensures a perfect centering and exceptional adhesion

diameter	thickness	attach- ment	code	stock	
Ø 115	8	M14	115VELSCN	●	1
Ø 125	8	M14	125VELSCN	●	1

AX EXTRA - CENTRAL BUTTON



EXTRA HOOK AND LOOP WITH HEAT-RESISTANT VELCRO

diameter	attach- ment	code	stock	
Ø 75	M14	75VELVZ	●	1
Ø 115	M14	115VELVZ	●	1
Ø 125	M14	125VELVZ	●	1

EXTRA - HEAT RESISTANT



➤ Interlayer foam - heat-resistant

EXTRA HOOK AND LOOP WITH HEAT-RESISTANT VELCRO

diameter	code	stock	
Ø 75	75IT	●	1
Ø 115	115IT	●	1
Ø 125	125IT	●	1

INTERLAYER FOAM - HEAT RESISTANT



● = available from stock

● = available in 5 working days

● = on request

> Back-up pads for eccentric grinders

STANDARD - HARD



STANDARD HOOK AND LOOP - HARD - BASE: NEOPRENE

diameter	thickness	attach-ment	holes	code	stock	
Ø 150	15	5/16"	0	150VELO	●	1

STANDARD - FLEXIBLE



STANDARD HOOK AND LOOP - FLEXIBLE - BASE: FLEXIBLE POLYURETHANE

diameter	thickness	attach-ment	holes	code	stock	
Ø 125	16	5/16"	0	125VELSUPER0	●	1
Ø 150	16	5/16"	0	150VELSUPER0	●	1
Ø 150	16	5/16"	6	150VELSUPER6	●	1
Ø 150	16	5/16"	Multi	150VELSUPERM	●	1
Ø 150	16	M8	Multi	150VELSUPERFM	●	1

STANDARD - FLEXIBLE



STANDARD HOOK AND LOOP - FLEXIBLE - BASE: FLEXIBLE POLYURETHANE

diameter	thickness	attach-ment	holes	code	stock	
Ø 150	10	5/16"	0	SMD54327	●	1
Ø 150	10	5/16"	6	SMD54328	●	1

➤ Back-up pads for flexible shafts & drill machines

STANDARD HOOK AND LOOP - BASE: THIN HARD NYLON

diameter	thickness	spindle diameter	code	stock	
Ø 25	5	Ø 3	25VEL3	●	1
Ø 50	5	Ø 6	50VEL6	●	1
Ø 75	5	Ø 6	75VEL6	●	1

STANDARD - HARD



STANDARD HOOK AND LOOP - BASE: THIN HARD NYLON + FOAM

diameter	thickness	spindle diameter	code	stock	
Ø 25	13	Ø 3	25SP10VEL3	●	1
Ø 50	20	Ø 6	50SP20VEL6	●	1
Ø 75	20	Ø 6	75SP20VEL6	●	1

STANDARD - HARD + FOAM



● = available from stock

● = available in 5 working days

● = on request

> Fibre disc back-up pads for angle grinder

HARD BACK-UP PAD



HARD BACK-UP PAD

- Properties:**
- Grinding with hard contact
 - Faster and more aggressive material removal

diameter	attach- ment	code	stock	
Ø 115	M14	FIW115	●	1
Ø 125	M14	FIW125	●	1
Ø 171	M14	FIW178	●	1
Ø 218	M14	FIW230	●	1

FLEXIBLE BACK-UP PAD



FLEXIBLE BACK-UP PAD

- Properties:**
- Grinding with soft contact
 - Controlled removal
 - Finer finish

diameter	attach- ment	code	stock	
Ø 115	M14	FIZ115	●	1
Ø 125	M14	FIZ125	●	1
Ø 171	M14	FIZ178	●	1
Ø 171	5/8"	FIZ179	●	1
Ø 218	M14	FIZ230	●	1

HARD BACK-UP PAD (HP)



HARD BACK-UP PAD - HIGH PERFORMANCE

- Properties:**
- Ventilated back-up pads
 - Guarantee a hard and stable contact at all times
 - Extremely heat-resistant

diameter	attach- ment	code	stock	
Ø 115	M14	FIH115	●	1
Ø 125	M14	FIH125	●	1
Ø 171	M14	FIH178	●	1

Shafts and spindles

spindle diameter	attach-ment	code	useful width		for wheels and discs of bore Ø	for use with	stock		
			min.	max.					
Ø 6	-	MHS1	-	-	5 mm	Finishing wheel T10	●	1	 <p>Ø 6 mm</p>
Ø 6	-	MHS2	2	22	6 mm	Finishing wheel (see p. 332 & 336)	●	1	 <p>Ø 6 mm</p>
Ø 6	-	MHS4	3	3	10 mm	Tex discs (see p. 176)	●	1	 <p>Ø 6 mm</p>
Ø 6	-	MHS5	4	6	10 mm	Tex discs (see p. 176)	●	1	 <p>Ø 6 mm</p>
Ø 6	-	MHS11	2,5	20	25,4 mm	Finishing wheel (see p. 332 & 336)	●	1	 <p>Ø 6 mm</p>
Ø 8	-	MHS12	2,5	20	25,4 mm	Finishing wheel (see p. 332 & 336)	●	1	 <p>Ø 8 mm</p>
Ø 6	-	MHS6	2,5	20	10+22 mm	CSD-discs (see p. 179) Polishing materials (see p. 366) General use	●	1	 <p>Ø 6 mm</p>

>>

● = available from stock

● = available in 5 working days

● = on request



	spindle diameter	attach-ment	code	useful width		for wheels and discs of bore Ø	for use with	stock	📦
				min.	max.				
 Ø 8 mm	Ø 8	–	MHS7	2,5	20	12 mm	CSD-discs (see p. 179) Polishing materials (see p. 366) General use	●	1
 Ø 8 mm	Ø 8	–	MHS8	2,5	8	14+25,4 mm	Finishing wheel (see p. 332 & 336)	●	1
 Ø 8 mm	Ø 8	–	MHS9	2,5	25	14+25,4 mm	Finishing wheel (see p. 332 & 336)	●	1
 Ø 8 mm	Ø 8	–	MHS10	2,5	50	14+25,4 mm	Finishing wheel (see p. 332 & 336)	●	1
 Ø 8 mm	Ø 8	–	MHA4	L= 20 mm	–	M14	Inflatable wheels - Type: NU223 (see p. 467)	●	1
 Ø 8 mm	Ø 8	–	MHA5	L= 40 mm	–	M14	Inflatable wheels - Type: NU331, NU525, NU534 (see p. 467)	●	1
 M14	–	M14	MHD1	2,5	8	25,4 mm	Finishing wheel (see p. 332 & 336)	●	1



>>

spindle diameter	attach-ment	code	useful width		for wheels and discs of bore Ø	for use with	stock	📦	
			min.	max.					
–	M14	MHD2	2,5	25	25,4 mm	Finishing wheel (see p. 332 & 336) Grinding wheels (see p. 322, 326 & 330) Technical brushes (see p. 398, 403 & 407)	●	1	
–	M14	MHD3	2,5	50	25,4 mm	Finishing wheel (see p. 332 & 336) Grinding wheels (see p. 322, 326 & 330) Technical brushes (see p. 398, 403 & 407)	●	1	
–	M14	MHD8	–	–	1/4"	Quick Change supports without spindle (see p. 296)	●	1	
–	M14	MHD9	–	–	shaft 3 up to 100 mm	Quick Change supports (see p. 313) Grinding wheels on spindle (see p. 338) Finishing wheels together with MHS8, MHS9, MHS10, MHS11, MHS12.	●	1	
–	M14	MHD10	L= 20 mm	–	M14	Inflatable wheels - Type: NU223 (see p. 467)	●	1	
–	M14	MHD11	L= 40 mm	–	M14	Inflatable wheels - Type: NU331, NU525, NU534 (see p. 467)	●	1	

>>

● = available from stock

● = available in 5 working days





● = on request



spindle diameter	attach-ment	code	useful width		for wheels and discs of bore Ø	for use with	stock	
			min.	max.				
 M14	M14	MHD4	60	85	16 mm	Polishing materials (see p. 366) Grinding wheels (see p. 322, 326 & 330) Technical brushes (see p. 398, 403 & 407)	●	1
 M14	M14	MHD5	70	95	16 mm	Polishing materials (see p. 366) Grinding wheels (see p. 322, 326 & 330) Technical brushes (see p. 398, 403 & 407)	●	1
 M14	M14	MHD6	90	120	16 mm	Polishing materials (see p. 366) Grinding wheels (see p. 322, 326 & 330) Technical brushes (see p. 398, 403 & 407)	●	1
 M14	M14	MHD7	15	50	14+22mm	Polishing materials (see p. 366)	●	1
 Ø 8 mm	–	MHS15	–	–	6 mm	Extension shafts with 6 mm attachment. To be mounted on: Drill heads, machines with flexible shaft and slow rotating straight grinders	●	1
 Ø 8 mm	–	MHS16	–	–	6 mm	Extension shafts with 6 mm attachment. To be mounted on: drill heads, machines with flexible shaft and slow rotating grinders.	●	1



>>

spindle diameter	attach-ment	code	useful width		for wheels and discs of bore Ø	for use with	stock	📦	
			min.	max.					
Ø 8	-	MHS17	-	-	6 mm	Extension shafts with 6 mm attachment. To be mounted on: Drill heads, machines with flexible shaft and slow rotating straight grinders.	●	1	
Ø 6	-	MHS18	-	-	3 mm	Spira rolls (see p. 390)	●	1	
Ø 3	-	MHS19	-	-	3 mm	Spira rolls (see p. 390)	●	1	
Ø 6	-	MHS20	-	-	3 mm	Reduction of Ø 6 to Ø 3 mm Spindle mounted cloth flap wheels	●	1	
Ø 6	-	MHS26	-	-	-	Quick-Lock wheels (see p. 347)	●	1	

● = available from stock

● = available in 5 working days

● = on request

➤ Reducing flanges

ALUMINIUM OR NYLON

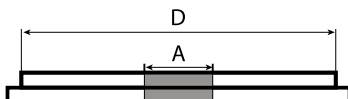

ALUMINIUM OR NYLON

Suitable for: I.a. flap brushes and wheels with centre holes, see p. 322, 326 & 330

diameter D	diameter A	code	stock	
Ø 150	Ø 25	RAL15025	●	2
Ø 127	Ø 32	RAL12732	●	2
Ø 115	Ø 25	RAL11525	●	2
Ø 110	Ø 16	RAL11016	●	2
Ø 100	Ø 10	RAL10010	●	2
Ø 100	Ø 25	RAL10025	●	2
Ø 76	Ø 25	RAL7625	●	2
Ø 54	Ø 50	RAL5450	●	2

NYLON WITH ALUMINIUM INNER RING

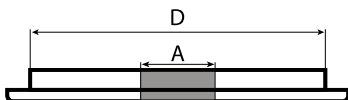

NYLON WITH ALUMINIUM INNER RING

Suitable for: I.a. grinding wheels with centre holes, see p. 322, 326 & 330

diameter D	diameter A	code	stock	
Ø 76	Ø 10	RNY76/10	●	2
Ø 76	Ø 16	RNY76/16	●	2
Ø 76	Ø 20	RNY76/20	●	2
Ø 76	Ø 22	RNY76/22	●	2
Ø 76	Ø 25	RNY76/25	●	2
Ø 76	Ø 30	RNY76/30	●	2
Ø 54	Ø 10	RNY54/10	●	2
Ø 54	Ø 16	RNY54/16	●	2
Ø 54	Ø 20	RNY54/20	●	2
Ø 54	Ø 22	RNY54/22	●	2
Ø 54	Ø 25	RNY54/25	●	2
Ø 54	Ø 30	RNY54/30	●	2

➤ Reducing flanges

NYLON

Suitable for: I.a. ventilated wheels, see p. 367

diameter D	diameter A	code	stock	
Ø 50	Ø 20	RV5020	●	2
Ø 50	Ø 25	RV5025	●	2
Ø 50	Ø 30	RV5030	●	2

NYLON

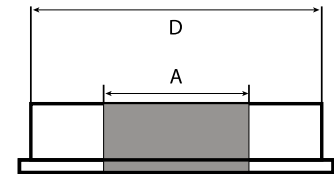

STAINLESS STEEL

Suitable for: I.a. unitized wheels with centre holes, see p. 332 & 336

diameter D	diameter A	code	stock	
Ø 25,4	Ø 10	MHF1	●	1
Ø 25,4	Ø 12	MHF2	●	1
Ø 25,4	Ø 14	MHF3	●	1
Ø 25,4	Ø 16	MHF4	●	1

STAINLESS STEEL

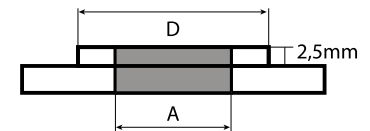

● = available from stock

● = available in 5 working days

● = on request

> Reducing flanges

UNIVERSAL FLANGE SET

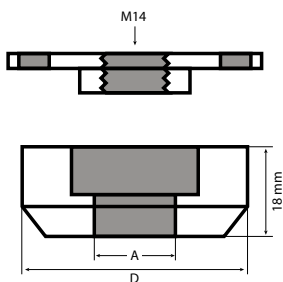

UNIVERSAL FLANGE SET

Use: The Cibo 'universal flange set' ensures that you can safely mount any disc to an angle grinder and prevents the machine's shaft from damaging the workpiece.

diameter D	diameter A	code	stock	
Ø 40	Ø 14,4	MHD13	●	1

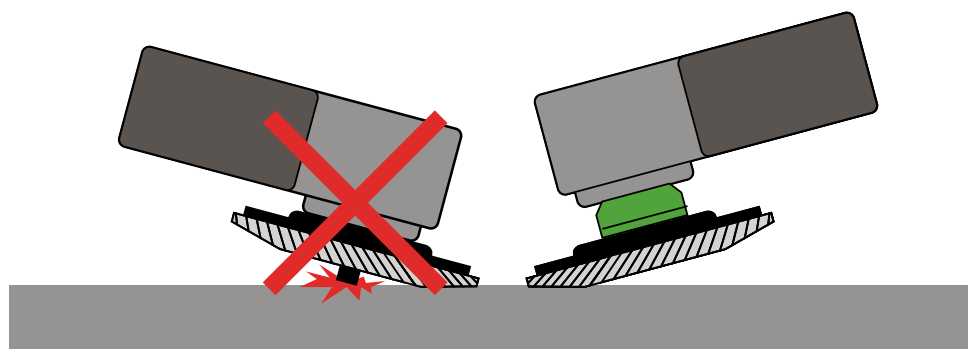

TAF FLAPDISCS



TAF FLAP DISCS WITH PLASTIC BACKING

code	stock	
MHD14	●	1

REDUCING RINGS NYLON

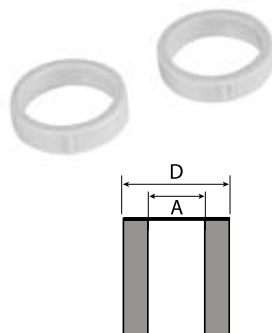

> Reducing rings

NYLON

Suitable for: Grinding stones

diameter D	diameter A	code	stock	
Ø 32	Ø 25	RSS3025	●	2
Ø 25	Ø 20	RSS2520	●	2
Ø 20	Ø 16	RSS2016	●	2
Ø 20	Ø 15	RSS2015	●	2
Ø 20	Ø 13	RSS2013	●	2

> Flanges for angle grinders

UPPER FLANGE

Attachment	code	stock	
M14	SMFL100080	●	1

UPPER FLANGE



LOWER FLANGE

Attachment	code	stock	
M14	SMFL191604	●	1

LOWER FLANGE



> Stainless steel flanges for Finit-Easy

UPPER FLANGE

code	stock	
SMFE/A1010	●	1

UPPER FLANGE



LOWER FLANGE

code	stock	
SMFE/A1009	●	1

LOWER FLANGE



● = available from stock

● = available in 5 working days

● = on request

> Mandrels

CYLINDER



FLAT

diameter	height	spindle diameter	code	stock	
Ø 5	10	Ø 3	SKVH0510	●	1
Ø 7	12	Ø 3	SKVH0712	●	1
Ø 10	15	Ø 3	SKVH1015	●	1
Ø 13	17	Ø 3	SKVH1317	●	1
Ø 16	26	Ø 6	SKVH1626	●	1

ROUND



ROUND

diameter	height	spindle diameter	code	stock	
Ø 5	11	Ø 3	SKBH0511	●	1
Ø 7	13	Ø 3	SKBH0713	●	1
Ø 10	15	Ø 3	SKBH1015	●	1
Ø 13	19	Ø 3	SKBH1319	●	1
Ø 16	26	Ø 6	SKBH1626	●	1

POINTED



POINT

diameter	height	spindle diameter	code	stock	
Ø 10	15	Ø 3	SKPH1015	●	1
Ø 16	26	Ø 6	SKPH1626	●	1

CONICAL



CONICAL

diameter	height	spindle diameter	code	stock	
Ø 16	32	Ø 6	SKCH1632	●	1
Ø 21	40	Ø 6	SKCH2140	●	1

> Mandrels

CONE

diameter	height	code	spindle diameter	stock	
Ø 8	85	SHKH0885	Ø 6	●	1
Ø 18	85	SHKH1885	Ø 6	●	1

CONE



> Spira supports

CYLINDRICAL - HARD

diameter	height	spindle diameter	code	stock	
Ø 10	20	Ø 6	SHSH1020	●	1
Ø 15	30	Ø 6	SHSH1530	●	1
Ø 22	20	Ø 6	SHSH2220	●	1
Ø 30	30	Ø 6	SHSH3030	●	1
Ø 45	30	Ø 6	SHSH4530	●	1
Ø 60	30	Ø 6	SHSH6030	●	1

SPIRAL



CONICAL - HARD

diameter	height	spindle diameter	code	stock	
Ø 22	30	Ø 6	SHCH2230	●	1
Ø 22	60	Ø 6	SHCH2260	●	1

CONICAL - SLEEVES



CYLINDRICAL - EXTRA SOFT

diameter	height	spindle diameter	code	stock	
Ø 75	30	Ø 6	SHEH7530	●	1

SPIRAL - SLEEVES



Extra soft support 30° shore for use with flexible abrasive sleeves.

● = available from stock

● = available in 5 working days

● = on request

> Hand sanding systems

SANDING BLOCKS - DOUBLE FACED



BLOCK – DOUBLE FACED

- Properties:**
- Foam rubber block provided with grip adhesive on both sides
 - Two different densities in a single hand sanding block
 - Ideal for coarse and fine sanding work
 - Grip sanding sheets can be replaced quickly

dimensions	code	stock	
125x70	HBDU12570	●	1

SANDING BLOCKS - SINGLE FACED



BLOCK – SINGLE FACED

- Properties:**
- Foam rubber block ergonomically shaped
 - Provided with grip adhesive on one side
 - Grip sanding sheets can be replaced easily

dimensions	code	stock	
125x70	HBEN12570	●	1

ABRASIVE FILE



ABRASIVE FILE

The perpetually working file, due to the grip grinding strips that can be replaced quickly

- Properties:**
- Super quick replacement of strips
 - Choice of various grades and grit sizes
 - Any aggressiveness and finish is possible
 - Always razor-sharp and ready for work

- Applications :**
- Profiling finish wheels
 - Plastics, copper, brass, stone
- (Sheets for abrasive file: see p. 437.)

dimensions	code	stock	
190x30	SV19030	●	1



See chapter grinding wheels (p. 337) for more information about profiling finishing wheels.

> Hand sanding systems

TEX HANDLE

Provided with strong hooks so that the tex sheets hook tightly on the handle.

Applications :

- Cleaning oxidation
- Structuring stainless steel
- Coating removal of primers
- Matting lacquers
- Surface preparation

dimensions	code	stock	
140x80	HG14080	●	1

TEX PAD SUPPORT



> Spray glue

SPRAY GLUE

volume	code	stock	
500 ml	SPLA	●	1

SPRAY GLUE



> Inoxiclean

INOXICLEAN SPRAY

Application :

- Maintaining stainless steel
- Removing dirt and grease traces on the workpiece after sanding
- Gives a brushed workpiece a shiny gloss

Use: In combination with a very soft clean piece of cloth (flannel or microfiber) to avoid damaging the work piece

volume	code	stock	
400ml	SPIC	●	3

INOXICLEAN SPRAY



INOXICLEAN CHALK (VIENNA CHALK)

Applications: Removing polishing pastes

code	stock	
PV103	●	1

INOXICLEAN CHALK



● = available from stock

● = available in 5 working days

● = on request

> Inoxitape

INOXITAPE



INOXITAPE

- Application:** • Protecting certain parts of a workpiece during the sanding process
- Properties :** • Self adhesive
• Packed in a handy dispenser box

length	width	thickness	code	stock	
5000	40	0,15	MHIT	●	1



Tips & Tricks: Brush the weld seam in mitre



Step 1

Cut the Inoxitape to size using scissors.



Step 2

Remove the tape strip and stick the Inoxitape from corner to corner. Press the Inoxitape firmly onto the work-piece. Make sure the work piece has cooled for the tape to stick properly.



Step 3

Sand lengthwise along the structure up to the Inoxitape. Use the wheel to brush along the tape to make sure the structure is correctly positioned along the entire cutting line. That way you can work close to the tape, without crossing the side of the finishing wheel.

Turn the work piece and stick the Inoxitape to the other side of the mitre. Repeat the previous steps on this side.



Step 4

Remove the tape and then use Inoxiclean and very soft tissue (e.g. microfiber or flannel) to remove any glue traces or dirt from the work piece and protect it against fingerprints and grease stains.

Wool felt

WOOL FELT ECRU

Applications: For coating grinding soles, grinding shoes and pressure plates of most belt grinders. The felt in turn is coated with graphite cloth.

Advantages:

- Shock damping
- Heat damping
- Improves quality
- Increases comfort

dimensions	density	thickness	code	stock	
1000x150	350	5	MHV5350	●	1
1000x150	350	10	MHV10350	●	1
1000x150	350	3	MHV3350	●	1

FELT ECRU



Graphite cloth

GRAPHITE CLOTH

width	code	stock	
Max 920	CIGRA-840	●	1



For ordering: please fill in the code **CIGRA-840** with the desired dimensions.

GRAPHITE CLOTH



Drive belts for finishing machines

DRIVE BELTS

machine	year of construction machine	code	stock	
Finit-Easy	year constructed < 10/2009	SMFE/R	●	1
Finit-Easy	year constructed > 10/2009	SMFEN/005	●	1
Finitube	year constructed < 4/2008	SMFT/R	●	1
Finitube	year constructed > 4/2008	SMFTN/009	●	1

DRIVE BELTS



SMFE/R - SMFT/R



SMFEN/005 - SMFTN/009

● = available from stock

● = available in 5 working days

● = on request