

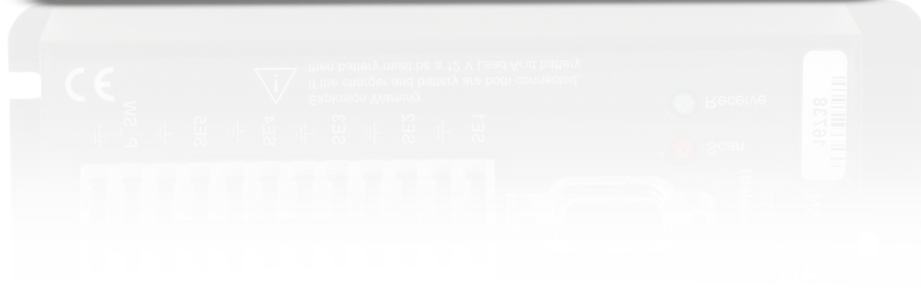

# CR200X Series

Measurement and Control Dataloggers

*Rugged, Reliable, and Ready for any Application*



# CR200X-Series<sup>a</sup> Dataloggers/Wireless Sensors

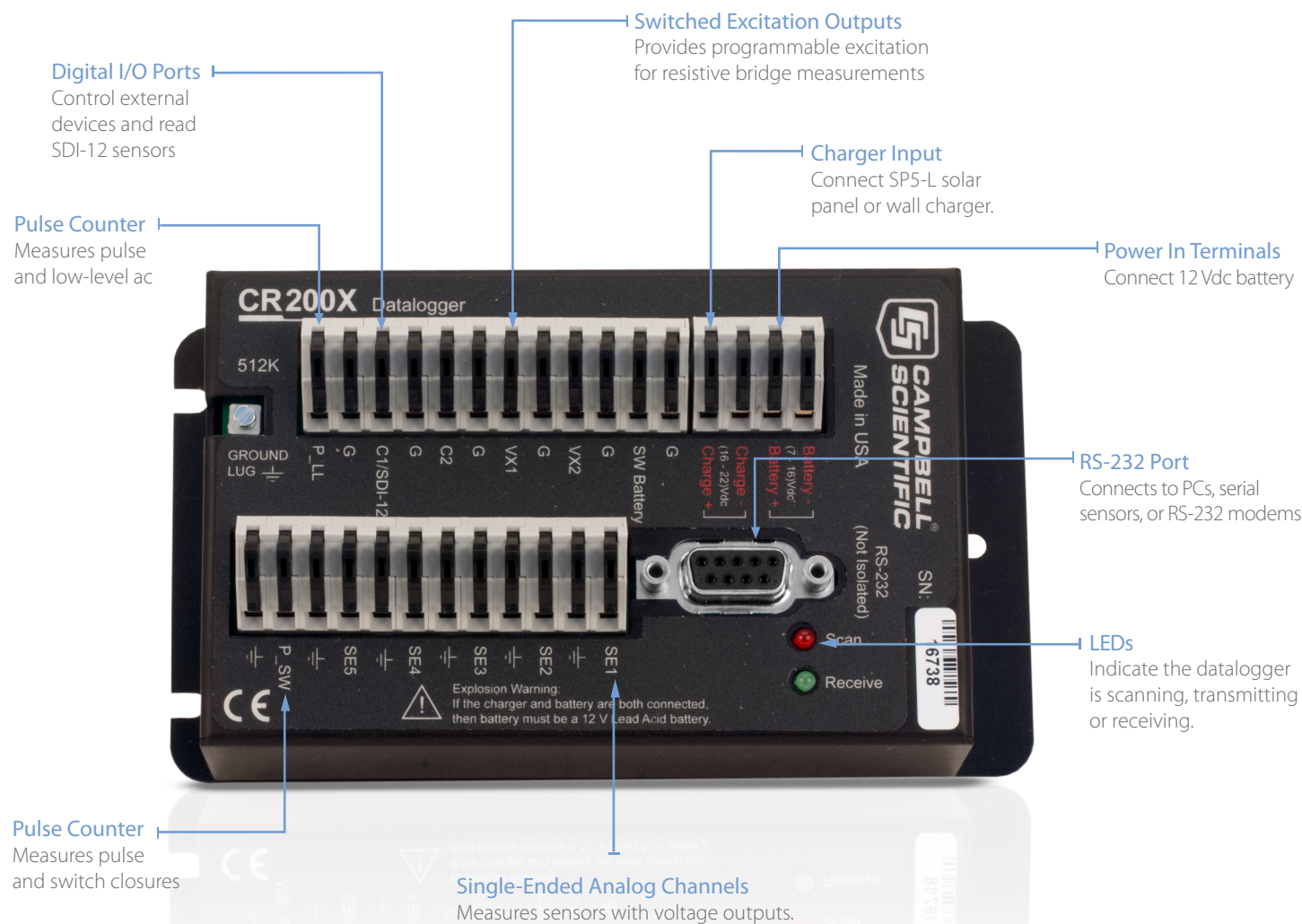

## Benefits and Features

- › Campbell Scientific's smallest, lowest cost datalogger
- › Optimal for measuring one or two simple sensors
- › 512 kB of flash final storage memory; ~125,000 data points
- › Fastest scan rate of once per second
- › 12-bit analog to digital conversions
- › Gas Discharge Tube (GDT) protected inputs
- › Data values stored in tables with a time stamp and record number
- › Battery-backed clock that ensures accurate time is maintained while a CR200X-series datalogger is disconnected from battery power
- › PakBus<sup>®</sup> communication protocol used, which is a simplified variation of Internet protocols

## Input/Output Channels

Gas discharge tubes provide rugged electrostatic discharge protection for the inputs. The CR200X-series loggers have five single-ended analog inputs, one switch closure pulse input, one low level ac pulse input, two control ports, two excitation channels (2.5 or 5 V), and one switched battery output. One of the control ports can be used as an SDI-12 port. Input voltage range is 0 to +2500 mV with 0.6 mV resolution. Please note that differential measurements are not supported.

## Program/Data Storage

Programs and data are stored in a non-volatile Flash memory. Final storage has 512 kB of memory that provides approximately 125,000 data points in the table-based memory structure.

**<sup>a</sup>End-of-Life Product:** For new projects, the CR300-series dataloggers are recommended instead of the CR200X-series dataloggers. The CR300-series dataloggers build on the successful features of the CR200X-series dataloggers, while adding new features. The CR200X-series dataloggers will continue to be available for customers with existing CR200X networks until 16 January 2018. Refer to the CR200X-Series Datalogger Discontinuation Notice (<https://s.campbellsci.com/documents/us/miscellaneous/CR200X-Series%20Datalogger%20Discontinuation%20Notice.pdf>) for details.

## Models/Communications

All of the models can communicate with a PC via direct connect, NL201 Network Link Interface, NL240 Wi-Fi Network Link, MD485 multidrop modem, and our digital cellular modems. Data can also be viewed on an iOS device, an Android device, or CD295 DataView II Display. To use an iOS or Android device, go to the Apple Store or Google Play and get our LoggerLink Mobile Apps.

Other communications are model specific. The CR200X is the base datalogger (i.e., supports communications listed at right). Our CR206X, CR211X, and CR216X include an internal spread spectrum radio that allow them to communicate wirelessly. The CR295X includes an additional 9-pin serial port that allows communications with the TX321 satellite transmitter for GOES or Meteosat.

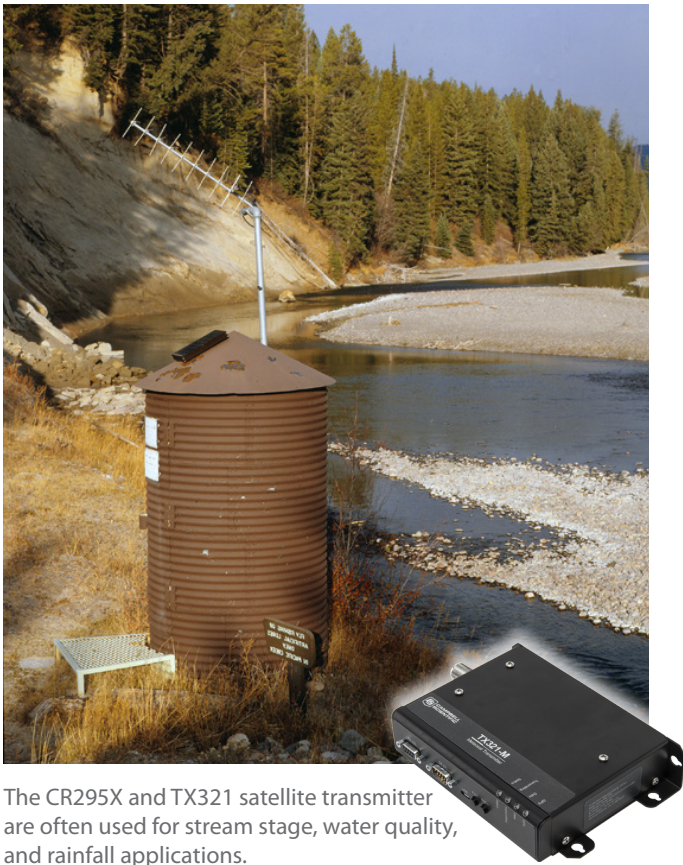

The CR295X and TX321 satellite transmitter are often used for stream stage, water quality, and rainfall applications.

### Internal Spread Spectrum Radio of the CR206X, CR211X, and CR216X

Model	Where Used	Power	Frequency	Communicates With
CR206X	U.S., Canada	250 mW <sup>b</sup>	910 to 918 MHz	CR206(X), RF401A, RF401, RF400, CR205
CR211X	Australia, New Zealand	250 mW <sup>b</sup>	920 to 928 MHz	CR211(X), RF411A, RF411, RF410, CR210
CR216X <sup>c</sup>	many countries worldwide	50 mW	2.450 to 2.482 GHz	RF216(X), RF416, RF432, CR215, RF415

<sup>b</sup>Older CR206X dataloggers (serial # < 19122) and older CR211X dataloggers (serial # < 19143) had 100 mW radios. Newer dataloggers that have 250 mW radios must use OS 3 or higher for their datalogger operating system.

<sup>c</sup>Purchase of this product is not recommended for new networks deployed in the European Union (EU) that may require future expansion. This and other RF compatible products will not be available for sale in Europe after 1/1/2015 due to changes in EU legislation.

## Software

### Starter Software

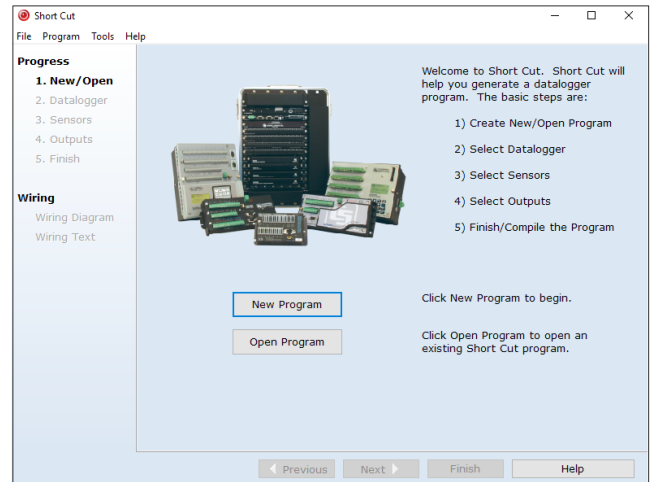

Short Cut is available from our website (at no charge) and our Resource DVD, and is bundled with our PC200W, PC400, and LoggerNet Software.

Our easy-to-use starter software is intended for first time users or applications that don't require sophisticated communications or datalogger program editing. SCWin Short Cut generates straight-forward datalogger programs in four easy steps. PC200W allows customers to transfer a program to, or retrieve data from a datalogger via a direct communications link.

At [www.campbellsci.com/downloads](http://www.campbellsci.com/downloads), the starter software can be downloaded at no charge. Our Resource DVD also provides this software as well as PDF versions of our brochures and manuals.

### Datalogger Support Software

Our datalogger support software packages provide more capabilities than our starter software. These software packages contains program editing, communications, and display tools that can support an entire datalogger network.

PC400, our mid-level software, supports a variety of telemetry options, manual data collection, and data display. For programming, it includes both Short Cut and the CRBasic program editor. PC400 does not support combined communication options (e.g., phone-to-RF), PakBus<sup>®</sup> routing, and scheduled data collection.

LoggerNet is Campbell Scientific's full-featured datalogger support software. It is referred to as "full-featured" because it provides a way to accomplish almost all the tasks you'll need to complete when using a datalogger. LoggerNet supports automatic data collection and PakBus<sup>®</sup> routing.

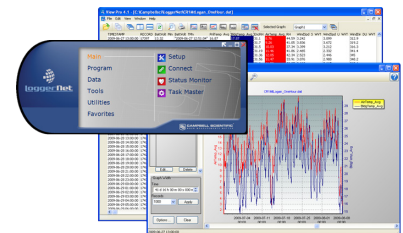

## Enclosures

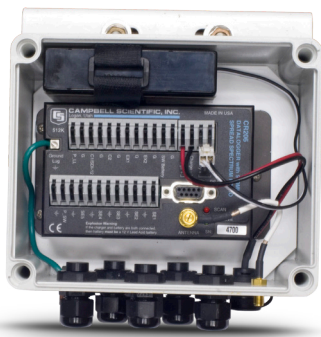

The ENC200 is a very small enclosure and has the dimensions of 17 cm by 14 cm by 9.4 cm (6.7 in by 5.5 in by 3.7 in).

Applications with minimal power requirements can use the ENC200 enclosure to house the datalogger and the #16869 sealed rechargeable battery. This very small enclosure has one power connector, one antenna connector, and five compression fittings.

The ENC200 cannot house a barometer or a battery that is larger than the #16869. However, an ENC10/12 or ENC12/14 enclosure is adequate for most CR200X, CR206X, CR211X, or CR216X-based systems. An ENC16/18, ENC24/30, or ENC24/30S enclosure can house a CR295X-based system.

## Power Supply

Sealed rechargeable battery options for the CR200X, CR206X, CR211X, or CR216X include the BP7 7 Ah battery and the #16869 0.8 Ah battery. These batteries should be recharged either with a solar panel or ac wall charger.

Campbell Scientific offers the SP5-L 5 W Solar Panel that attaches directly to the datalogger's terminal strip, and the SP5 5 W Solar Panel that plugs into the ENC200's power connector. AC wall charger options are the #15988 wall charger that attaches directly to the datalogger's terminal strip, and the #16876 wall charger that plugs into the ENC200's power connector. Typical power supply for a CR295X-

based system consists of a BP12 12 Ah or BP24 24 Ah battery pack, CH150 or CH200 regulator, and SP10 10 W or SP20 20 W solar panel.



The SP5 and SP5-L are suitable for sites with good exposure to sunlight and systems with low power requirements.

## Antennas and Antenna Accessories

### CR206X and CR211X Antennas

- **14204**—0 dBd, omnidirectional ½ wave whip, jointed, adjustable from 0° to 90°. Connects directly to the datalogger; no antenna cable needed.
- **15970**—1 dBd, dipole supplied with window/wall mount and a 10 foot RG-174 cable for connecting to the datalogger.

- **14221**—3 dBd, omnidirectional with mounts; requires an antenna cable to connect to the datalogger.
- **14201**—9 dBd, Yagi with mounts; requires an antenna cable to connect to the datalogger.

### CR216X Antennas

- **16005**—0 dBd, ½ wave whip articulating. Connects directly to the datalogger; no antenna cable needed.
- **30411**—5.8 dBd (8 dBi), omnidirectional that uses the #13906 mounting hardware; requires an antenna cable to connect to the datalogger.

- **16755**—13 dBd, Yagi with mounts; requires an antenna cable to connect to the datalogger.

### Antenna Cables and Surge Protector Kit

- **COAXRPSMA-L**—low-loss RG58 cable that is recommended for lengths less than 3 m (10 ft).

- **COAXNTN-L**—low-loss RG8 cable that is recommended for lengths greater than 3 m (10 ft); requires a #31314 surge protector kit.
- 31314**—Surge Protector Kit used with the COAXNTN-L coaxial cable.



## Compatible Sensors<sup>d</sup>

The CR200X-series dataloggers can measure a variety of sensors including SDI-12 sensors and 4 to 20 mA sensors. The parameters and sensors in which the CR200X series can measure are listed below:

- › **AC Current**—CS11 Current Transformer.
- › **Barometric Pressure**—CS100, CS106, and 092 barometers.
- › **Evaporation**—255-100 Evaporation Gauge.
- › **Leaf Wetness**—237 and LWS leaf wetness sensors.
- › **Multiparameter**—WXT520 Weather Transmitter.
- › **Precipitation**—TE525, TE525WS, TE525MM, TB4, TB4MM, CS700, and 52202 tipping bucket rain gages.
- › **Relative Humidity**—CS215, HMP60, HC2S3, 083E, and HMP155A air temperature and relative humidity probes.
- › **Snow Depth**—SR50A- and SR50AT-series Sonic Ranging Sensors.
- › **Soil Volumetric Water Content**— EasyAG probe, EnviroSCAN probe, CS650 reflectometer, CS655 reflectometer, and CS625 reflectometer. *Our CS616 is not compatible.*
- › **Solar Radiation**—CS300 Pyranometer and SP230 Heated Pyranometer. *Our LI200X, LI190SB, LP02, CMP3, CMP6, CMP11, CMP21, NR-LITE2, NR01, and CNR4 probes are not compatible.*
- › **Temperature**—109, 109SS, and 110PV thermistors. *Other temperature probes listed on our price lists including our 107/108 thermistors and thermocouples are not compatible.*
- › **Water Level**—CS451, CS456, and CS460 pressure transducers; CS410 Shaft Encoder; CS470 and CS471 compact bubblers; CS475, CS476, and CS477 pulse radar sensors, and SR50A- and SR50AT-series Sonic Ranging Sensors.
- › **Water Quality**—OBS-3+, OBS300, OBS500, and OBS501 turbidity probes; 109 and 109SS temperature probes, and CS511 dissolved oxygen probe. *Our CS526, CS547A, CSIM11, CSIM11-ORP, 107, and 108 probes are not compatible.*
- › **Wind Speed and Direction**—014A, 024A, 034B, 03101, 03002, 05103, 05108, 05108-45, 05106, 05305, 27106T, ICEFREE3A, ICEFREE3V, P2546A, A100LK, and WindSonic4 sensors. *The WindSonic1, CSAT3 series, and Zephir300 are not compatible.*

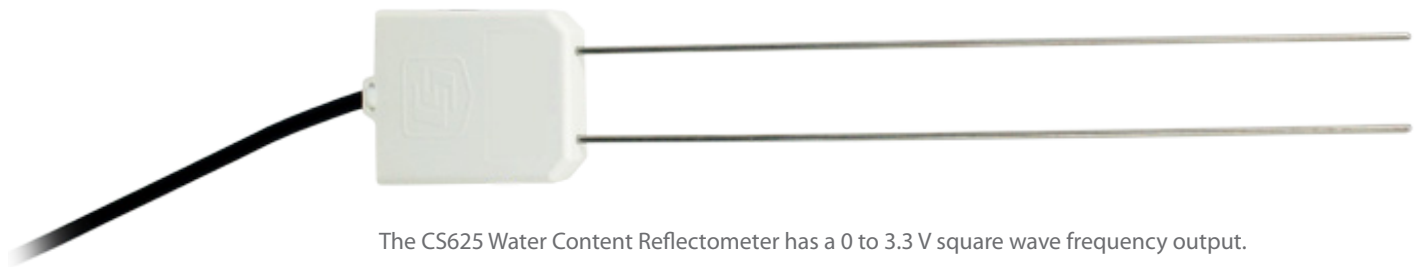

The CS625 Water Content Reflectometer has a 0 to 3.3 V square wave frequency output.



The 109 thermistor can measure air, water, or soil temperature from -50° to +70°C. This probe outputs a signal of 0 to 2.2 V.

<sup>d</sup>The CR200X-series dataloggers can not make differential measurements. They are not compatible with the freezing-rain/ice, fuel moisture/temperature, geographic position, present weather, soil heat flux, snow water equivalent, soil matric water potential, strain, and visibility sensors listed on our price lists. Campbell Scientific's SDMs, CDMs, and multiplexers are also not supported.

## CR206X/RF401A-based Wireless Sensor Networks

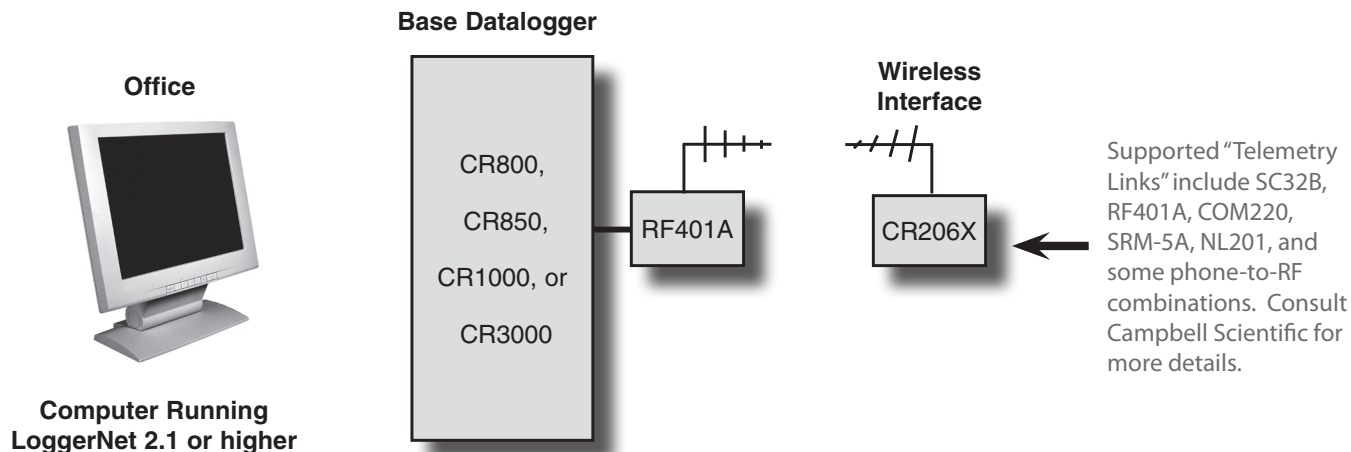

In a simple network, the measurements are transmitted directly to the computer.

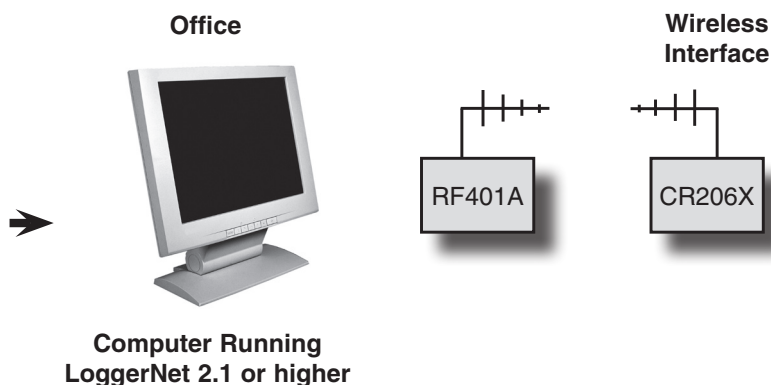

## Applications

### Wireless Sensor Networks

The CR206X, CR211X, and CR216X can be used in a wireless sensor network. Wireless sensor networks are appealing because they are often more economical than trenching, laying conduit, and pulling wire. In some applications, cabled sensors are impractical due to man-made or natural causes, including construction, lightning, moving platforms, agricultural production, or bodies of water.

The diagrams at the top of the page depict our CR206X/RF401A-based wireless sensor networks. Our CR211X/RF411A-based and CR216X/RF416-based networks are similar.

All wireless sensor networks require LoggerNet 2.1 or higher software. The base datalogger must use the PakBus communication protocol. The PakBus protocol was optional for our retired CR510, CR10X, and CR23X dataloggers; the PakBus operating system is available, at no charge, from: [www.campbellsci.com/downloads](http://www.campbellsci.com/downloads) for these dataloggers.

### Other Applications

- **Aquaculture**—monitors and records water quality around the clock providing continuous data that can be used to identify trends and improve production.
- **Rural Water**—provides continuous monitoring of the water system regardless of time of day or time of year. All monitored sites can be networked into one integrated system.
- **Water Level/Flow**—measures level in many environments including wells, dams, streams, weirs, and water treatment or wastewater treatment plants. Compatible with shaft encoder, pressure transducers, compact bubblers, radar water level sensors, and sonic ranging sensor.
- **Water Quality**—monitors and records water temperature, pH, dissolved oxygen, and turbidity.
- **Wind Energy**—can be deployed in a wireless network configuration to provide cost effective monitoring at each level of a wind assessment tower while avoiding long cables.

# CR200X-series Datalogger Specifications

Electrical specifications are valid over a  $-40^{\circ}$  to  $+50^{\circ}\text{C}$  range unless otherwise specified; non-condensing environment required. We recommend that you confirm system configuration and critical specifications with Campbell Scientific before purchase.

## ANALOG INPUTS; DIGITAL I/O

Channels SE1 to SE5 can be individually configured for single-ended measurement or digital I/O.

### SINGLE-ENDED MEASUREMENT (SE1 TO SE5):

Analog Input Range:  $0 \leq V < 2.5$  Vdc

Measurement Resolution: 0.6 mV

Measurement Accuracy

Typical:  $\pm(0.25\%$  of reading + 1.2 mV offset) over  $-40^{\circ}$  to  $+50^{\circ}\text{C}$

Worst-case:  $\pm(1\%$  of reading + 2.4 mV offset) over  $-40^{\circ}$  to  $50^{\circ}\text{C}$

### DIGITAL I/O (SE1 TO SE5):

Input/Output High State: 2.1 to 3.3 Vdc

Input/Output Low State:  $<0.9$  Vdc

Output High State: 3.3 V (no load)

Drive Current: 220  $\mu\text{A}$  @ 2.7 Vdc

Maximum Input Voltage: 4 Vdc

### HALF BRIDGE MEASUREMENTS:

Accuracy: Relative to the excitation.

Using +2.5 Vdc excitation, is  $\pm(0.06\%$  of reading + 2.4 mV)/(2.5 Vdc)

### PERIOD AVERAGING (SE1 TO SE4):

Maximum Input Voltage: 4 Vdc

Frequency Range: 0 to 150 kHz

Voltage Threshold: counts cycles on transition from  $<0.9$  Vdc to  $>2.1$  Vdc

### EXCITATION CHANNELS (VX1 AND VX2):

Range: Programmable 0, 2.5, 5 Vdc, or off (floating)

Accuracy:  $\pm 25$  mV on +2.5 Vdc range,  $\pm 125$  mV on +5.0 Vdc range

Maximum Current: 25 mA on +2.5 Vdc range, 10 mA on +5.0 Vdc range

## CONTROL PORTS (C1 AND C2)

### DIGITAL I/O:

Voltage Level When Configured as Input:  $<0.9$  Vdc (low state) to  $>2.7$  Vdc (high state)

Voltage Level When Configured as Output: 0 V (low state), 5 Vdc (high state) (no load)

Logic Level: TTL

Drive Current: 1.5 mA @ 4.5 V

SDI-12: SDI-12 sensors connect to C1

## PULSE COUNTERS

### SWITCH CLOSURE (P\_SW):

Maximum Count Rate: 100 Hz

Minimum Switch Open Time: 5 ms

Minimum Switch Closed Time: 5 ms

Maximum Bounce Time: 4 ms

### PULSE COUNT (P\_SW, C1, AND C2):

Voltage Threshold: count on transition from  $<0.9$  V to  $>2.7$  Vdc

Minimum Pulse Width: 320  $\mu\text{s}$

Maximum Input Frequency: 1 kHz

Max Input Voltage: C1 & C2 (6.5 V), P\_SW (4 Vdc)

### LOW LEVEL AC (P\_LL):

Voltage Threshold:  $<0.5$  V to  $>2$  V

Minimum Input: 20 mV RMS

Maximum Frequency: 1 kHz

Maximum Input:  $\pm 20$  V

Note: C1 and C2 can be used for switch closure using the battery voltage and a 100 kOhm pull-up resistor. If the dc offset is  $>0.5$  V, then AC coupling is required.

## COMMUNICATIONS

SERIAL INTERFACE: Female RS-232 9-pin interface for logger-to-PC communications

### ON-BOARD SPREAD SPECTRUM RADIO:

Frequency: 915 MHz (CR206X), 922 MHz (CR211X), or 2.4 GHz (CR216X)

Transmission Range: 1 mile with 0 dBd  $\frac{1}{4}$  wave antenna (line-of-sight) and 900 MHz radios; 0.6 miles (1 km) with 0 dBd  $\frac{1}{2}$  wave antenna (line-of-sight) and 2.4 GHz radio; up to 10 miles with higher gain antenna (line-of-sight)

RF4XX used as a base station radio

Transmitter Power Output:  
250 mW (CR206X, CR211X);  
50 mW (CR216X)

### AVAILABLE RADIO TRANSMISSION MODES:

Always on, program controlled

Cycle Time: 1 or 8 s cycles; on for 100 ms every period; checks for incoming communication

Scheduled Transmission Time: off until transmission time

PAkBUS<sup>®</sup> packet switching network protocol

## CLOCK ACCURACY

8.2 minutes/month @  $-40^{\circ}$  to  $+50^{\circ}\text{C}$ ; 1 minute/month @  $+25^{\circ}\text{C}$

## CPU AND STORAGE

FINAL STORAGE: 512 kB flash memory, data format is 4 Bs per data point

INTERMEDIATE STORAGE: 8 kB SRAM

COMPILED PROGRAM STORAGE: up to 19.2 kB flash memory depending on structure of CRBasic program

OPERATING SYSTEM: 106 kB flash memory

FASTEST SCAN RATE: once per second

## SWITCHED BATTERY (SW BATTERY)

Switched under program control. Thermal fuse hold current = 670 mA @  $-40^{\circ}\text{C}$ ; 500 mA @  $20^{\circ}\text{C}$ ; 290 mA @  $70^{\circ}\text{C}$

## POWER

BATTERY VOLTAGE RANGE: 7 to 16 Vdc (can program datalogger to measure internal battery voltage)

MAXIMUM CONTINUOUS BATTERY CHARGING CURRENT:  
0.9 A @  $20^{\circ}\text{C}$ ; 0.65 A @  $50^{\circ}\text{C}$

RECOMMENDED BATTERIES: 12 Vdc, 7 Ah or smaller sealed rechargeable battery when connected to the on-board charging circuit. Using larger batteries with the datalogger's built-in charger may result in excessive PC board heating. This is especially a concern when the battery is deeply discharged or failing with a shorted cell.

Alkaline cells, lithium, or other non-rechargeable battery types may be connected if the charging circuit is not used (i.e., nothing connected to Charge terminals).

CHARGER INPUT VOLTAGE: 16 to 22 Vdc

SOLAR PANEL: 10 W or smaller when using on-board charging circuit.

WALL CHARGER: 1 A or smaller when using on-board charging circuit.

SHELF LIFE OF CLOCK'S BACKUP BATTERY: 5 years

## CURRENT DRAIN (@ 12 V)

QUIESCENT CURRENT DRAIN:  
No Radio or Radio Powered Off:  $\sim 0.2$  mA

### ACTIVE CURRENT DRAIN:

No radio  $\sim 3$  mA

Radio receive  $\sim 20$  mA (CR206X, CR211X),  $\sim 36$  mA (CR216X)

Radio transmit  $\sim 75$  mA (CR206X, CR211X, CR216X)

AVERAGE CONTINUOUS CURRENT DRAIN:  
Radio always on  $\sim 20$  mA (CR206X, CR211X),  $\sim 36$  mA (CR216X)

Radio in 1 s duty cycle  $\sim 2.2$  mA (CR206X, CR211X),  $\sim 4$  mA (CR216X)

Radio in 8 s duty cycle  $\sim 0.45$  mA (CR206X, CR211X),  $\sim 0.8$  mA (CR216X)

## CE COMPLIANCE (as of 10/15)

CE COMPLIANT DATALOGGERS: CR200X

STANDARD(S) TO WHICH CONFORMITY IS DECLARED: IEC61326:2002

## EMI AND ESD PROTECTION

IMMUNITY: Meets or exceeds following standards:  
ESD: per IEC 1000-4-2;  $\pm 8$  kV air,  $\pm 4$  kV contact discharge

RF: per IEC 1000-4-3; 3 V/m, 80-1000 MHz

EFT: per IEC 1000-4-4; 1 kV power, 500 V I/O

Surge: per IEC 1000-4-5; 1 kV power and I/O

Conducted: per IEC 1000-4-6; 3 V 150 kHz-80 MHz

Emissions and immunity performance criteria available on request.

## PHYSICAL

CASE DESCRIPTION: Aluminum with spring-loaded terminals

DIMENSIONS (including terminals):

14.0 cm x 7.6 cm x 5.1 cm; 5.5 in x 3 in x 2 in

WEIGHT:

CR200X or CR295X: 242 g (8.5 oz)

CR206X, CR211X, or CR216X: 271 g (9.5 oz)

CUSTOM CASE: available for OEM applications; contact Campbell Scientific

## WARRANTY

Three year covering parts and labour.



# Global Sales & Support Network

A worldwide network of companies to help meet your needs

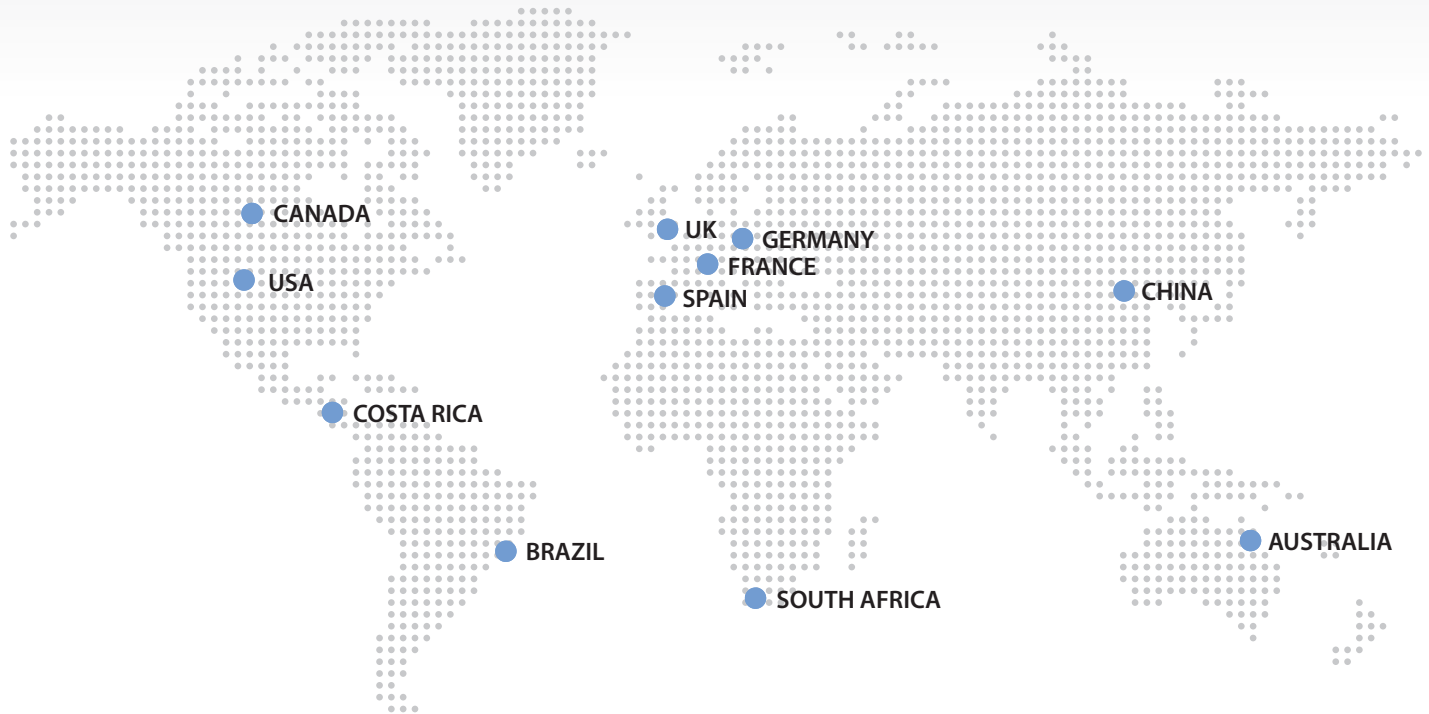

## Australia

*Location:* Garbutt, QLD Australia  
*Phone:* 61.7.4401.7700  
*Email:* [info@campbellsci.com.au](mailto:info@campbellsci.com.au)  
*Website:* [www.campbellsci.com.au](http://www.campbellsci.com.au)

## Brazil

*Location:* São Paulo, SP Brazil  
*Phone:* 11.3732.3399  
*Email:* [vendas@campbellsci.com.br](mailto:vendas@campbellsci.com.br)  
*Website:* [www.campbellsci.com.br](http://www.campbellsci.com.br)

## China

*Location:* Beijing, P. R. China  
*Phone:* 86.10.6561.0080  
*Email:* [info@campbellsci.com.cn](mailto:info@campbellsci.com.cn)  
*Website:* [www.campbellsci.com](http://www.campbellsci.com)

## Canada

*Location:* Edmonton, AB Canada  
*Phone:* 780.454.2505  
*Email:* [dataloggers@campbellsci.ca](mailto:dataloggers@campbellsci.ca)  
*Website:* [www.campbellsci.ca](http://www.campbellsci.ca)

## Costa Rica

*Location:* San Pedro, Costa Rica  
*Phone:* 506.2280.1564  
*Email:* [info@campbellsci.cc](mailto:info@campbellsci.cc)  
*Website:* [www.campbellsci.cc](http://www.campbellsci.cc)

## France

*Location:* Antony, France  
*Phone:* 0033.0.1.56.45.15.20  
*Email:* [info@campbellsci.fr](mailto:info@campbellsci.fr)  
*Website:* [www.campbellsci.fr](http://www.campbellsci.fr)

## Germany

*Location:* Bremen, Germany  
*Phone:* 49.0.421.460974.0  
*Email:* [info@campbellsci.de](mailto:info@campbellsci.de)  
*Website:* [www.campbellsci.de](http://www.campbellsci.de)

## South Africa

*Location:* Somerset West, South Africa  
*Phone:* 27.21.8800885  
*Email:* [cleroux@csafrica.co.za](mailto:cleroux@csafrica.co.za)  
*Website:* [www.csafrica.co.za](http://www.csafrica.co.za)

## Spain

*Location:* Barcelona, Spain  
*Phone:* 34.93.2323938  
*Email:* [info@campbellsci.es](mailto:info@campbellsci.es)  
*Website:* [www.campbellsci.es](http://www.campbellsci.es)

## UK

*Location:* Shepshed, Loughborough, UK  
*Phone:* 44.0.1509.601141  
*Email:* [sales@campbellsci.co.uk](mailto:sales@campbellsci.co.uk)  
*Website:* [www.campbellsci.co.uk](http://www.campbellsci.co.uk)

## USA

*Location:* Logan, UT USA  
*Phone:* 435.227.9000  
*Email:* [info@campbellsci.com](mailto:info@campbellsci.com)  
*Website:* [www.campbellsci.com](http://www.campbellsci.com)

## Other Locations

Sales and support are provided in many other locations through an extensive network of international reps. For the full list, please visit [www.campbellsci.com/directory](http://www.campbellsci.com/directory).