



**MATJACK | Indianapolis Industrial Products, Inc.**

**2320 Duke St., Indianapolis, IN 46205**

**Toll Free: 1-800-827-3755**

**Phone: 317-359-3078, Fax: 317-359-3079**

**Email: [matjack@sprynet.com](mailto:matjack@sprynet.com)**

**[www.matjack.com](http://www.matjack.com)**



- ◆ Portable Roadways
- ◆ Yard Mats
- ◆ Jack Pads
- ◆ Poly Ground Cover Mats
- ◆ Tracked Vehicle Mats
- ◆ Poly Sand Mats
- ◆ Foot Traffic Mats
- ◆ Ditch Bridge



**Visit our website**  
  
**[www.matjack.com](http://www.matjack.com)**



**MATJACK | Indianapolis Industrial Products, Inc.**

**2320 Duke St., Indianapolis, IN 46205**

**Toll Free: 1-800-827-3755**

**Phone: 317-359-3078, Fax: 317-359-3079**

**Email: [matjack@sprynet.com](mailto:matjack@sprynet.com)**

**[www.matjack.com](http://www.matjack.com)**

## Portable Roadway Systems



- + Super strength, light weight fiberglass panels
- + Strongest "man-handleable" mat in the industry
- + Rigid panel reduces 75 psi tire load to 11 psi
- + Axle loads of 30,000 lbs., off road conditions
- + Bend, but don't roll up, don't break
- + Most aggressive traction surface in the industry
- + Non-electrical conductive, great for power line work



**For Rubber Tire/Track  
Vehicles Only!  
No Steel Tracks.**

- + Easily handled by men in the field.
- + Fit in the back of a pick up truck.
- + Textured on both sides for traction.
- + Not affected by water, gas, oil or chemicals. Made to do a tough job for years of service.
- + Rope Handles for easy lifting.
- + Ground PSI much lower than plastic, plywood or planks.
- + Steel Connectors available; overlap joint for strongest connection.
- + Off-white color keeps them cool in summer heat, no damage to lawns.



**Drilling**



**Structure Mover**



**Heavy Construction**

**Utilities**



**Tree Service**



**Cranes**



# When You've Got to Get Through.

**Roadways** are made from space-age materials that allow the panels to bend and twist. This flexibility prevents breakage under extreme loads. Full size panels spread the load over 30 sq. ft. of solid footprint. Pound for Pound **Roadways** are stronger than wood, steel or plastic. **Roadways** provide maximum flotation. If the ground supports a man walking, **Roadways** will take your equipment to the site.



Textured on both sides for traction. **Roadways** can be easily handled by men in the field and transported in a pick-up truck. Manufactured with rope handle standard, hand cutout optional on some models so you can grab and go. **Roadways** provide maximum load spread for the least PSI of any mat on the market. They are not affected by water, gas, oil or chemicals. No splintering and rotting like plywood. Steel connectors using the mat overlap configuration for the strongest possible link.

**Roadways** are super strength, light weight engineered composite fiberglass panels. The **Super Mat HDS** Series can support **axle loads** of 30,000 lbs. in off-road conditions. The **Yard mat HD** and **Super Light HD SL** mats are designed for use when the load factors are not as demanding as the Super Mat requirements.

**Indianapolis Industrial Products, Inc.**  
**2320 Duke Street**  
**Indianapolis, IN 46205**  
**800-827-3755**  
**(317) 359-3078**  
**Fax (317) 359-3079**  
**www.matjack.com**  
**email: matjack@sprynet.com**



**Roadways** Whether you're driving over lawns or through a rain soaked field, there is a Model to fit your need.

**Yard Mats**—Vehicles weight ( under 35,000 lbs.)

- Model MJN2296HD (22" x 96" x 5/16") 28 lbs.
- Model MJN3296HD (32" x 96" x 5/16") 40 lbs.
- Model MJN4572HD (45" x 72" x 5/16") 60 lbs.

Typical user, cemeteries, electric distribution, tree trimmers, film. Vehicle weight (under 60,000 lbs.)

**Ground mats lite duty mats** -Vehicle weight (under 60,000 lbs.)

- Model MJ2296HDSL (22" x 96" x 3/8") 38 lbs.
- Model MJ3296HDSL (32" x 96" x 3/8") 55 lbs.
- Model MJ4572HDSL (45" x 72" x 3/8") 56 lbs.
- Model MJ4596HDSL (45" x 96" x 3/8") 75 lbs.
- Model MJ60120HDSL (5' x 10' x 3/8") 125 lbs.

Typical user, utilities for off road, rental companies, light cranes, special events.

**Ground mats heavy duty mat**— Vehicles weight (up to 120,000 lbs.)

- Model MJ2296HDS (22" x 96" x 0.40") 46 lbs.
- Model MJ3296HDS (32" x 96" x 0.40") 64 lbs.
- Model MJ4572HDS (45" x 72" x 0.40") 70 lbs.
- Model MJ4596HDS (45" x 96" x 0.40") 92 lbs.
- Model MJ60120HDS (5' x 10' x 0.40") 150 lbs.

Typical user: transmission line crews, well drillers, cranes, house movers.

**Special sizes—Super Mats**

- Model MJN7272HDS (80" x 80") effective face (6' x 6')
- Model MJN72144HDS effective face (6' x 12')





# YARD MATS



## Whatever Your Business:

- Cemeteries
- Golf Courses
- Landscapers
- Special Events
- Utilities
- Tree Service

- **Yard mats** are the strongest and lightest panels available.
- Composite fiberglass materials allows panels to bend and twist, but not break from heavy loads.
- Textured on both sides for good vehicle and ground traction.



- **Yard mats** allow you to drive over curbs and sunken areas without damage.
- Perfect temporary Roadways that prevent damage to lawns, underground utilities and sprinkler systems.
- No more restoration to lawns when the job is finished.
- For Vehicles under 35,000 lbs.



# YARD MATS



- **Yard mats** Designed with Ergonomics in mind.
- Features helps control injury costs.
- Manufactured with either Hand-Cut Outs or Rope Handles.
- Their size and weight allow them to be utilized by workers in the field.
- No special equipment required.

- **Yard mats** Come in different sizes for a variety of applications.
- Won't break, splinter or fold up.
- Size for Size Stronger & Lighter than Plastic Mats.
- Spreads load over a wider area than any other small mat.
- Doesn't absorb water like plywood.
- Unaffected by heat or cold.



**For Rubber Tire/Track Vehicles Only!**  
No Steel Tracks.

➔ Vehicle Weight (under 35,000 lbs).

- Model MJN220GHD (22" X 96" X 5'10") 22 lbs
- Model MJN320GHD (32" X 96" X 5'10") 40 lbs
- Model MJN4572HD (45" X 72" X 5'10") 47 lbs
- Model MJN4596HD (45" X 72" X 5'10") 60 lbs

**Indianapolis Industrial Products, Inc.**  
2320 Duke Street  
Indianapolis, IN 46205  
800-627-3755  
(317) 359-3078  
Fax (317) 359-3079  
www.matjack.com  
email: matjack@sprynet.com

Typical user: cemeteries, electric distribution, tree trimmers, film.



# OUTRIGGER PADS

## Drillers - Backhoes - Utilities

Super Strong, Pads Are Engineered Light Weight, Composite Fiberglass.

Takes Up Less Space.

They Are Not As Thick, Or Heavy When Compared to Other Materials.

Design Features A Non-skid Surface, Superior Traction, And Enhanced Finish For Improved Durability.

Rope Handles For Easy Set-up.

No Water Absorption. Won't Rot.

Lighter weight.

1 year Limited Warranty.

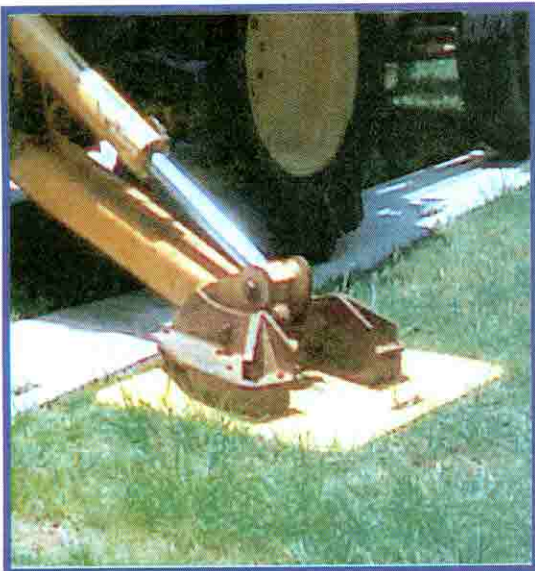

### Popular Models:

- MJ2424HDS (24" square) Every day use.  
Weight 12 lbs. Equipment under 25,000 lbs.
- MJ3232HDS (32" square) Every day use.  
Weight 30 lbs. Backhoes under 25,000 lbs.
- MJ1818 (18" square) Normal field use.  
Weight 12 lbs. Equipment up to 35,000 lbs.
- MJ2424 (24" square) Rough field use.  
Weight 20lbs. Most popular line of truck pads.
- MJ3232 (32" square) Demanding field use.  
Weight 38 lbs. Tandem equipment up to 70,000 lbs.



**Indianapolis Industrial Products, Inc.**  
2320 Duke Street  
Indianapolis, IN 46205  
800-827-3755  
(317) 359-3078  
Fax (317) 359-3079  
[www.matjack.com](http://www.matjack.com)  
email: [matjack@sprynet.com](mailto:matjack@sprynet.com)

# Poly Ground Cover Mats

- \* 6 Year Limited Warranty.
- \* You're a professional! Save Time!
- \* Get in, do the work, and get out clean.
- \* You want to do a good job for your client.
- \* A mat system tough enough to do the job.
- \* No ruts, damaged lawn, or weather delays.
- \* No more heavy, wet, slippery broken plywood.
- \* Cylinder Tread Design allows easy Load/Unload.

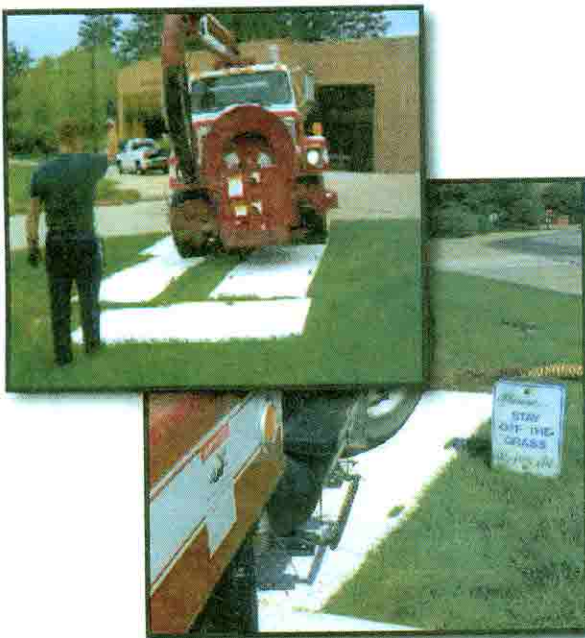

- \* Hand Cutouts for lifting.
- \* Corner holes for connectors.
- \* Tough 1/2" thick polyethylene.
- \* Made from 100% original material.
- \* Available either Light Color or Utility Black.
- \* Leading cleat design for superior surface traction.
- \* Withstands the weight of heavy vehicles & machinery.

For Rubber Tire/Track Vehicles Only!  
Not Recommended for Steel Tracks.

**Indianapolis Industrial Products, Inc.**  
2320 Duke Street  
Indianapolis, IN 46205  
800-827-3755  
(317) 359-3078  
Fax (317) 359-3079  
www.matjack.com  
email: matjack@sprynet.com



Model	Size	Weight
MJTM4496	44.5" X 8' (1.13 x 2.44m)	78 lbs. (35 kg)
MJTM3696	36" X 8' (0.90 x 2.44m)	64 lbs. (29 kg)
MJTM3672	36" X 6' (0.90 x 1.83m)	51 lbs. (23 kg)
MJTM2296	22.2" x 8' (0.56 x 2.44m)	39 lbs. (18 kg)
MJTM2248	22.2" x 4' (0.56 x 1.22m)	19 lbs. (9 kg)
MDirtboard	48" x 8' x 3/8" (1.22 x 2.44m)	60 lbs. (27 kg)

# Poly Ground Cover Mats

## Temperature Testing Results

Color does matter. We offer a light colored mat for a specific reason. It's not to make them pretty, but to control temperature. Anyone who works on grass for an extended period of time should be aware of the affect of sun on a dark surface. On an 85° day, in 2 hours a black mat can get hot enough to burn grass. A light colored mat can be left on grass up to 7 days without damage. After that, they need to be moved because the grass needs sunlight, which has been blocked off. There is a chance that grass will show some "yellowing because of lack of sunlight, but it will revive in a day or two when the mats are moved away.

### Test #1

1 Light Colored Mat, laid on a grassy surface.

- Ambient temperature - 85° F
- Test period - 2 hours
- Using infrared thermometer - 92° F under mat

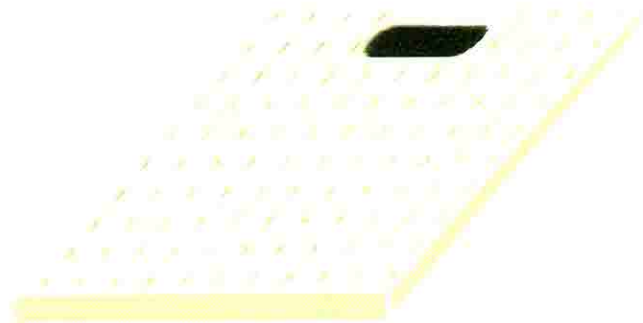

### Test #2 & 3

1 Black Colored Mat, laid on a grassy surface.

- Ambient temperature - 85° F
- Test period - 2 hours
- Using infrared thermometer - 150° F under mat

### #3

- Ambient temperature - 81° F
- Test period - 1 hours
- Using infrared thermometer - 130° F under mat



**Indianapolis Industrial Products, Inc.**  
2320 Duke Street  
Indianapolis, IN 46205  
800-627-3755  
(317) 359-3078  
Fax (317) 359-3079  
www.matjack.com  
email: matjack@sprynet.com



# QUALITY PERFORMANCE SOLUTIONS



**Poly Mat** is available in a Light Color material, keeps the mat cool in summer and prevents heat build up and burnt grass. That's important when clients have expensive landscape issues.

Mats are unaffected by heat or cold and are UV protected for extended life and utilization.

**Poly Mat** has many uses. Just let us know and we'll match your need to our mats.



Also available in Black if protection against heat build up is not an issue.

Connectors for **Poly Mat** are available in several ver-

2-Way  
Heavy Duty Urethane



4-Way  
Heavy Duty Urethane



Ground Stake



- \* **Poly Mat** is available with one side smooth when you need to protect surfaces from potential markings or indentations that could be caused by the traction cleat pattern.
- \* Require an Event Walkway? We have a version of **Poly Mat** called a "Ped" Mat designed specifically for that purpose. One side has a closely spaced traction pattern for pedestrian traffic while retaining the customary **Poly Mat** pattern on the other. There are No Hand Cut-Outs on the "Ped" series that could create a trip hazard.
- \* **Sand mats** are a great addition to our lineup. Sized for cars, vans and RV's with an aggressive steel traction surface, it will get you UNSTUCK. Mats work in sand, dirt, mud, ice and snow. It is all about TRACTION and MOMENTUM.
- \* **DirtBoards** when you need to excavate and hold the dirt near the site. Perfect for Cemeteries and similar applications. Black color with both sides a matte "orange peel" finish.



**Indianapolis Industrial Products, Inc.**  
 2320 Duke Street, Indianapolis, IN 46205  
 800-827-3755 or (317) 359-3078 Fax (317) 359-3079  
[www.mafack.com](http://www.mafack.com)  
 email: [mafack@sprynet.com](mailto:mafack@sprynet.com)

# TRACKED VEHICLE MATS

**“When you’ve got to get through”**



Stop road damage caused by bulldozers or other types of track vehicles with sturdy, environmentally conscious tracked vehicle mats. These mats prevent damage caused by steel treads crossing roadways, concrete, shop floors and driveways. Unlike tires or plywood, traffic can drive over the mats at highway speeds. They work great in cemeteries under front buckets to prevent damage to turf or markers.

**NO DAMAGE TO ROAD SURFACES.**

Tracked vehicle mats are designed with a rugged textured surface which will not allow track vehicles to slip or slide on wet or icy surfaces. These mats can also be used to line the bed of an equipment trailer to prevent slippage on the wood or steel surfaces.

**BEDLINER FOR EQUIPMENT TRAILER.**

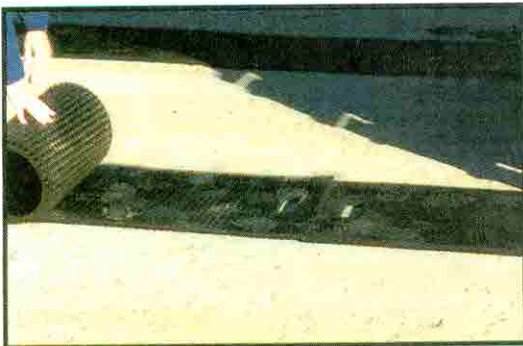

**EASY TO HANDLE.**

Tracked vehicle mats are lightweight and portable. Lay them flat or roll them up for easy storage. Mats weigh 40 lbs, are 2 ft. wide by 8 ft. long, with hand cut outs on both ends for easy handling.

**RUGGED, USE UNDER ANY SIZE TRACK**



**Indianapolis Industrial Products, Inc.**  
2320 Duke Street  
Indianapolis, IN 46206  
800-627-3755  
(317) 359-3078  
Fax (317) 359-3079  
www.matjack.com  
email: matjack@sprynet.com

***A Must Have for Dunes, Beach etc.  
Never Get Stuck Again !!***

# **POLY SAND MATS**



Poly sand mats are sold in pairs.

Poly sand mats are constructed of high density polyethylene. These mats will bend but not break.

Size is one foot wide and four feet long and one half inch thick. Approximate weight is 13 lbs per mat (26 lbs total).

***Poly sand mats work for all off road vehicles to include RVs.***



Poly sand mats are designed to get you unstuck. These mats will work in sand, dirt, mud, ice and snow. It is all about traction and momentum.



**Indianapolis Industrial Products, Inc.  
2320 Duke Street  
Indianapolis, IN 46205  
800-827-3755  
(317) 359-3078  
Fax (317) 359-3079  
www.matjack.com  
email: matjack@sprynet.com**

# FOOT TRAFFIC MATS

Temporary Sidewalks  
Special Events  
Tent Flooring



Foot traffic mats move people instead of vehicles efficiently and safely through the event.

The face of the mat is the nub pattern and there are no hand cutouts that could create a tripping hazard.



Superb, foot support,  
traction surface.

Quality • Reliability • Versatility

## Features:

- \* Corner holes for connectors.
- \* Tough 1/2" thick polyethylene.
- \* Made from 100% original material.
- \* Light Green (Recommended) or Utility Black.
- \* Cleat design for superior surface traction.
- Easy to clean cleats, no angles or corners.
- 6 year Limited Warranty

Size 44.5" X 8' 78 lbs.

For Rubber Tire/Track Vehicles Only!  
Not Recommended for Steel Tracks.

Special events, concerts, golf tournaments, festivals, picnics, graduations, backyard parties and outdoor wedding, etc.

Don't let unfavorable ground conditions ruin your party or event.



**Indianapolis Industrial Products, Inc.**  
2320 Duke Street  
Indianapolis, IN 46205  
800-827-3755  
(317) 359-3078  
Fax (317) 359-3079  
www.matjack.com  
email: matjack@sprynet.com

**MAT**  
  
**JACK**

**THE**

# **DITCH BRIDGE**



## **The DITCH BRIDGE Series**

All aluminum construction. Aircraft grade material for high strength and light weight.

No RUST! No PAINTING required.

NEW! Standard models to 24' long.

NEW! Models with lower side rails allowing clearance for almost any vehicle.

Standard Heavy Duty Models for vehicles up to 65,000 lbs.

### **WHEN YOU'VE GOT TO GET THROUGH!**

#### **DITCH BRIDGES:**

Are engineered to do the job safely unlike field fabricated bridging which is high risk.

The fast way to cross ditches, creeks, trenches, etc.

Lift in place with trucks you already have.

Prevents environmental damage and reduces or eliminates permit requirements.



**Indianapolis Industrial Products, Inc.**

**2320 Duke Street**

**Indianapolis, IN 46205**

**800-827-3755**

**(317) 359-3078**

**Fax (317) 359-3079**

**www.matjack.com**

**email: matjack@sprynet.com**

# DITCH BRIDGE SPECIFICATIONS

## 24' Bridge

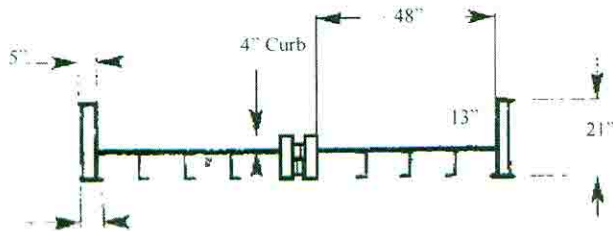
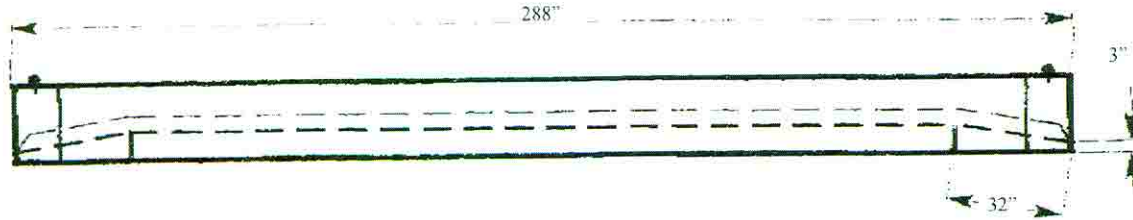

Capacity 24,000 lbs/ side.  
 Standard Models 24 Feet Long.  
 Two sections link together form a solid bridge with a usable width of 9'. Inside rails are 5" high, outside rails are 13" high. Outside rails prevent vehicles from driving off the bridge.

## Low Profile Bridge

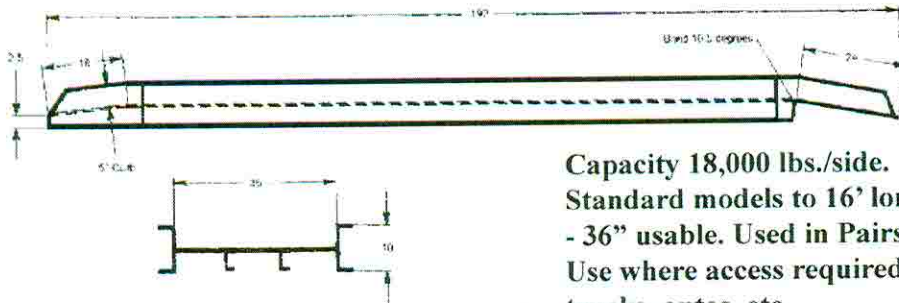

Capacity 18,000 lbs./side.  
 Standard models to 16' long. 42" overall width - 36" usable. Used in Pairs. Side rail, 5" high.  
 Use where access required by line trucks, Pickup trucks, autos, etc.

## Arched Bridge

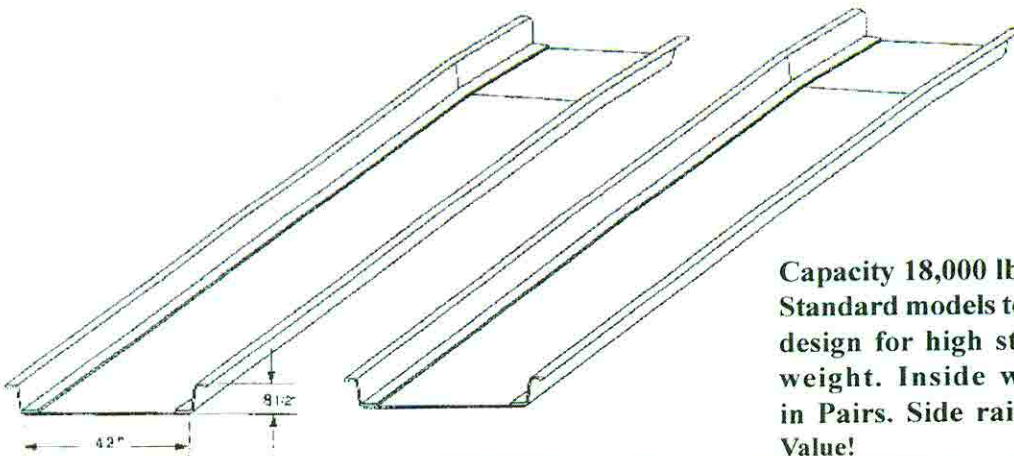

Capacity 18,000 lbs./side  
 Standard models to 16' long. Arched design for high strength and light weight. Inside width 42". Used in Pairs. Side rails, 8 1/2" high. Best Value!



# Other Great Matjack Products

***When failure isn't an option!***



***Matjack High, Medium, Low Pressure Air Bags***

***Underwater Lift bags, Landing Bags,***

***Plastic Cribbing, etc...***



***Visit our website***  
  
***www.matjack.com***



***Please visit our website for more information***

**Matjack / Indianapolis Industrial Products, Inc.**

**800-827-3755 / 317-359-3078**



**ISO 9001:2008 QMS CERTIFIED**