



KROHNE

▶ measure the facts

Level measurement

Product overview



Contents

5	Product selection
6-7	Overview Technology Icons
8-15	Radar (FMCW) level transmitters
16-21	Guided Radar (TDR) level transmitters
22-29	Magnetic level indicators (MLI)
30-38	Ultrasonic level transmitters
31-39	Displacer and Potentiometric level transmitters
40-51	Hydrostatic level measurement
52-57	Level switches
58-59	Communication technology
60-61	Services
62-63	Calibration

KROHNE trademarks:

KROHNE
measure the facts
CalSys
CARGOMASTER
EcoMATE
EGM
KROHNE Care
M-PHASE
OPTIBAR
OPTIBATCH
OPTIBRIDGE
OPTIFLEX
OPTIFLUX
OPTIMASS
OPTISENS
OPTISONIC
OPTISOUND
OPTISWIRL
OPTISWITCH
OPTISYS
OPTIWAVE
PipePatrol
WATERFLUX
SENSOFIT
SMARTBASE
SMARTMAC
SMARTPAT

Trademarks of other owners:

Amphenol
Bluetooth®
EtherNet/IP™
FDT Group
FOUNDATION™ fieldbus
HART®
HASTELLOY®
Metaglas®
PACTware
PROFIBUS®
PROFINET®
VARIVENT®



KROHNE – your global partner

KROHNE is your reliable partner for process instrumentation and automation. As our client, you benefit from our ability to solve your applications with matching measurement solutions; we offer a complete product portfolio, industry specific system solutions and complementary services for instrumentation projects of any size.

By having specialised in industrial process measurement since 1921, we have gained an enormous amount of application knowledge in various industries that is integrated into our products, solutions and services. We have truly mastered the physical principles our meters are based on: our ability to utilise physical effects and to find a matching measuring solution time after time are the reasons we are trusted by clients worldwide. The primary measured value is as accurate as possible to avoid consecutive faults that might affect your process control. It also enables our meters to measure reliably, even under changing or difficult process conditions. Both aspects are reflected by our claim “**Measure the facts**”.

The innovative technologies we employ for your benefit are based on our extensive R&D activities: 10% of the >3700 KROHNE employees work in research and development. Next to sensor physics, their focus is on device communication and enabling technologies for the Internet of Things (IoT) in process industry, e.g. ethernet communication to transmit process and device diagnostic data for evaluation and process optimisation.

Our “Technology Icons” perfectly sum up the above mentioned advantages for you. You will find them highlighted within our complete portfolio in this brochure. If you don’t find a matching solution for your measurement application, feel free to contact us, we look forward to solving it.



The solution for any application

KROHNE has unique expertise in the field of level measurement. We continuously demonstrate our capabilities in standard applications as well as applications considered challenging or requiring tailor-made solutions.

For us, customer orientation begins in the research and development phase. Many process instrument designs now considered to be industrial standards, were in fact developed by us in close cooperation with our customers. Today, users of devices from other market leaders benefit from KROHNE innovations: In 1990, we introduced the first radar for the process industry. Five years later, it was followed by a guided (TDR) radar level transmitter using electromagnetic pulses. OPTIWAVE and OPTIFLEX, a new generation of radar and TDR devices based on a unique and innovative operating philosophy, were launched in 2004 and redesigned. They provide high accuracy and reliability even in difficult applications. A complete series of level switches for liquids and solids as well as mechanical level indicators round out the KROHNE level portfolio.

Product selection list

The following table will help you in selecting the right measuring principle for your application

	Radar (FMCW)	Guided radar (TDR)	Magnetic float	Ultrasonic	Displacer	Pressure	Vibration	Capacitance
	Page 8-15	Page 16-21	Page 22-29	Page 30/32/33/38	Page 31/34/35/39	Page 40-51	Page 52-57	Page 53-57
	Continuous measurement						Switch measurement	
Liquids								
Storage tanks	+	+	+	+	+	+	+	+
Vapours	+	++	+	-	+	+	++	+
Agitation	++	o	o	-	o	+	++	+
High temperature >+200°C/+392°F	o	+	+	-	+	++	++	-
High pressure >100 barg/1450 psig	-	+	+	-	++	+	++	-
Low temperature <-50°C/-58°F	-	o	+	-	-	++	++	-
Low pressure (vacuum)	++	+	+	-	-	+	++	+
Interface	-	++	o	-	+	+	o	+
Slurries	++	+	-	+	-	o	o	+
Low ϵ_r value (<1.4)	-	o	+	+	+	++	++	o
Density change	++	+	o	+	o	o	+	++
Corrosive product	++	o	+	+	-	o	o	-
Foam	-	+	+	-	o	++	++	o
Viscous product (>5000 cp)	++	o	-	+	-	o	o	+
Still well/ reference chambers	+	+	++	-	+	o	++	+
Solids								
Bulk solids (e.g. rocks)	++	-	-	o	-	-	-	-
Granulates	++	o	-	+	-	-	++	o
Powders/ Dusty atmosphere	++	+	-	-	-	-	++	+
Other								
Internal obstructions	+	+	+	o	-	++	+	++
Long measuring range >35 m/114 ft	++	+	-	-	-	+	++	-
Deposit/Coating	++	+	o	-	-	-	o	+
Open-channel flow	+	-	-	++	-	-	-	-
Hygienic	++	+	-	o	-	+	+	++

++ = recommended, + = suitable, o = suitable under certain conditions, - = not suitable

Technology Icons

To deliver reliable values even under difficult conditions, KROHNE products and solutions use a number of high-end technologies.

These are highlighted by the technology icons, each representing a unique and characteristic feature that also generates additional benefit for users:



Ceramic durability

By implementing oxide ceramic sensors into OPTIFLUX and BATCHFLUX electromagnetic flowmeters as well as ceramic diaphragms into OPTIBAR pressure devices, KROHNE is using a superior material that is permanently resistant to corrosive and abrasive media and also immune to temperature shocks.



EGM™ Entrained Gas Management

EGM™ was developed for the OPTIMASS Coriolis mass flowmeters to overcome problems caused by air or gas entrainments in a liquid. Powerful control algorithms maintain measurement, even during a complete transition from a pure liquid phase to a gas phase and back. Mass flow and density measurements remain stable and continuous, which has been demonstrated in batch / loading / empty-full-empty applications.



Total 3D linearisation

For a robust and accurate differential pressure measurement, even under changing process conditions, each OPTIBAR DP 7060 differential pressure transmitter is linearised in 3 dimensions during calibration: differential pressure, ambient temperature and static pressure are taken into account in combination. Since the full specified operating range is covered, an outmost stable and accurate measurement under all process conditions is guaranteed.



SmartSense insulation monitoring

Temperature assemblies with Pt100 or thermocouple sensors can produce erroneous measurements due to humidity in the measuring insert, e.g. caused by wear, corrosion or cracks. OPTITEMP temperature transmitters with SmartSense monitor the temperature sensor and warn for isolation errors.



Transmitter built-in

The SMARTPAT series of analysis sensors significantly eases the handling of analytical sensors: formerly an external device, the transmitter has now been miniaturised and built into the sensor head, enabling direct 4...20 mA/HART® 7 communication. This reduces the costs of ownership, eases installation and maintenance, and allows for usage in Ex applications (zone 0).

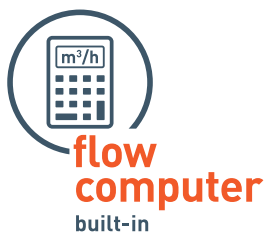

Flow computer built-in

Many KROHNE flowmeters have a built-in flow computer that compensates for the effects of pressure and temperature on the flow measurement or to convert to standard volume. The OPTISONIC 7300/8300 have analogue input for P & T sensors, the OPTISWIRL 4200 has both integrated. This saves both cost and installation efforts for an external flow computer.



80 GHz radar level measurement

The 80 GHz technology used in the OPTIWAVE series is the most recent and versatile radar technology for level measurement of liquids and solids. Over an identical distance, it presents a highly focused beam with a smaller diameter compared to lower frequency radars, ideal for dusty atmospheres or low reflective media. The small dead zone and narrow beam angle allow for use in both small and tall vessels.



Multiphase measurement

Multiphase measurement allows for the simultaneous measurement of flow rates of oil, water and gas in multiphase mixtures, without the need of separation. This saves time, costs, space and installation efforts compared to conventional test separators. Our magnetic resonance based multiphase flowmeter M-PHASE 5000 offers a full bore, non-radioactive solution for measuring multiphase flow.



E-RTTM pipeline leak detection

E-RTTM is a leading mathematical model for continuous internal monitoring of pipelines. Integrated in our PipePatrol system, it compares measurement data from the actual pipeline with those of a simulated "virtual pipeline" in real time. If the model detects a discrepancy, a leak signature analysis using leak pattern recognition determines whether it is a leak or safe, with outstanding accuracy.

For liquids



OPTIWAVE 1010 C
6 GHz FMCW radar
for liquids in bypass
chambers



OPTIWAVE 1400 C
24 GHz FMCW radar
for water and wastewater
applications



OPTIWAVE 3500 C
80 GHz FMCW radar
for liquids with hygienic
requirements



OPTIWAVE 5200 C/F
10 GHz FMCW radar
for liquids in storage and
process applications



OPTIWAVE 5400 C
24 GHz FMCW radar
for liquids
in basic process applications



OPTIWAVE 7400 C
24 GHz FMCW radar
for agitated
and corrosive liquids



OPTIWAVE 7500 C
80 GHz FMCW radar
for liquids in narrow tanks with
internal obstructions



OPTIWAVE-M 7400
24 GHz FMCW radar
for marine applications

For solids



OPTIWAVE 6400 C
24 GHz FMCW radar for solids
from granulates to rocks



OPTIWAVE 6500 C
80 GHz FMCW radar for powders
and dusty atmospheres

Accessories



OPTICHECK
Service tool for in-situ verification
of field devices

Radar (FMCW) level transmitters

Industries:

- Chemical
- Oil & Gas
- Power Generation
- Metal & Mining
- Environment
- Food & Beverage
- Pharmaceutical
- Agriculture
- Pulp & Paper
- Water & Wastewater

Non-contact level measurement



FMCW radar transmitters allow for the continuous, contactless level measurement of liquids, pastes, granulates, powders and other solids in a wide variety of industries.

With the OPTIWAVE 1010 (6 GHz), the OPTIWAVE 5200 (10 GHz) and now the OPTIWAVE series of 24 and 80 GHz radars, KROHNE offers the appropriate frequency for each application. The OPTIWAVE 5400 / 6400 / 7400 (24 GHz) and OPTIWAVE 3500 / 6500 / 7500 (80 GHz) radars are each designed for specific industry needs. They improve our portfolio for reliable and accurate level measurement of liquids and solids, even in most difficult applications.

KROHNE has more than 28 years' experience in providing superior FMCW radar devices to its customers.

1865

Continuous level measurement via radar is based on the theory of the propagation of electromagnetic waves, put forth by the British physicist James C. Maxwell in 1865. Maxwell postulated that the field lines of a changing magnetic field are surrounded by annular electrical field lines, even in the absence of electrical conductors.

1904

Inspired by this theory, German physicist Christian Hülsmeyer developed and patented the telemobiloscope, the first radar device of this type in Düsseldorf in 1904. For this innovation, he is rightly known as the inventor of the „original radar.“

1989

In 1989, KROHNE introduced the first radar level transmitter for process tanks.

Radar beam diameter for each frequency over identical distances, with the same antenna size

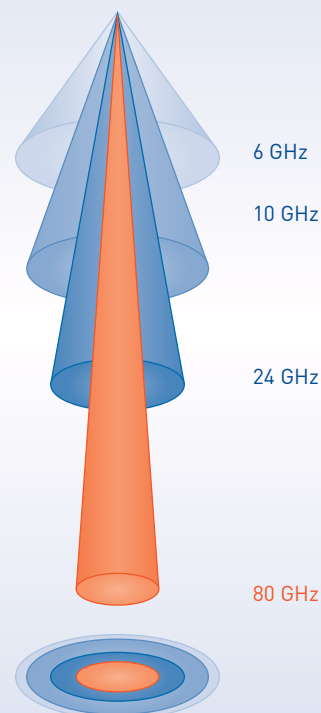

Radar (FMCW)

The measuring principle

The radar principle used is FMCW (Frequency Modulated Continuous Wave). The FMCW radar emits a high frequency signal whose frequency increases linearly during the measurement phase (called the frequency sweep). The signal is emitted via an antenna, reflected off the product surface and received with a time delay, t . Time delay, $t=2d/c$, where d is the distance to the product surface and c is the speed of light in the gas above the product. For further signal processing the difference Δf is calculated from the actual transmitted frequency and the received frequency. The difference is directly proportional to the distance. A large frequency difference corresponds to a large distance and vice versa. The frequency difference Δf is transformed via a Fast Fourier Transformation (FFT) into a frequency spectrum and then the distance is calculated from the spectrum. The level results from the difference between the tank height and the measured distance.

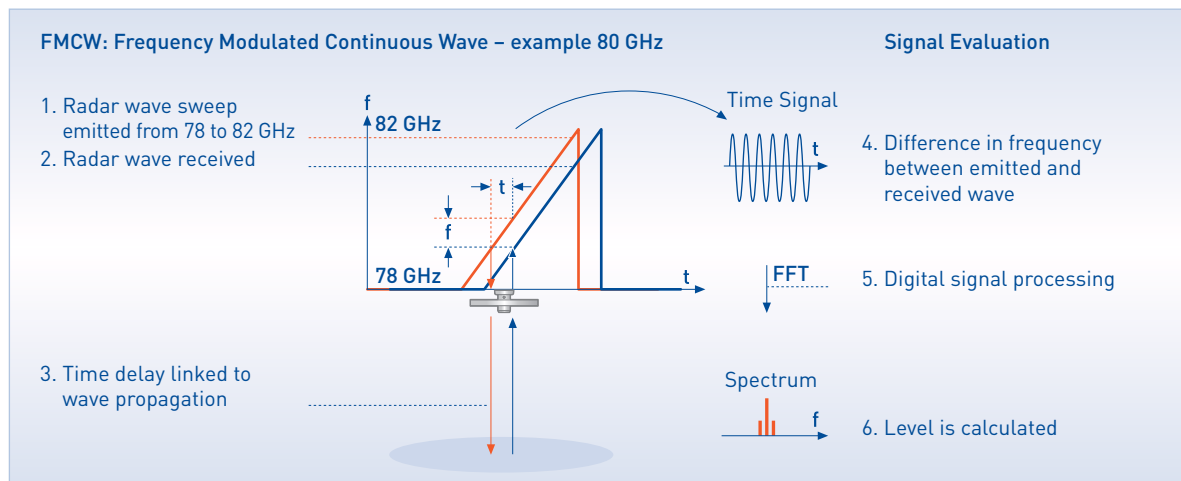



Empty tank spectrum for radar devices

All interference reflections, which are caused by fixed or moving tank internals and the tank bottom, can be detected and saved by recording an empty spectrum. The surface reflections are reliably detected, distinguished from interference reflections and analyzed by comparing the empty spectrum to the reflections in the filled state. For applications with tanks that cannot be emptied before device setup, the radar transmitter offers the capability of recording a partially empty spectrum.

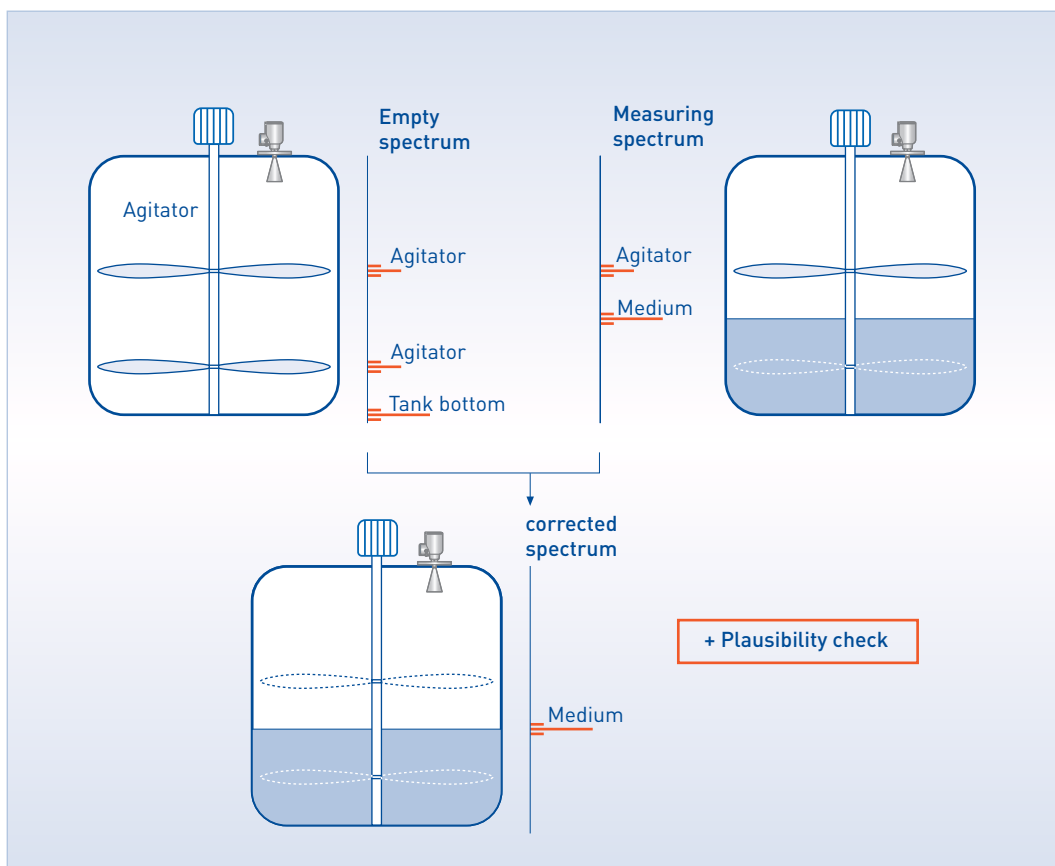

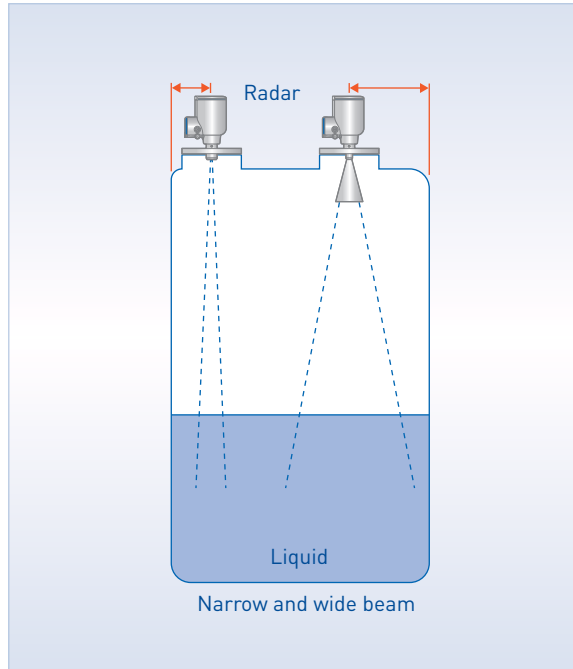



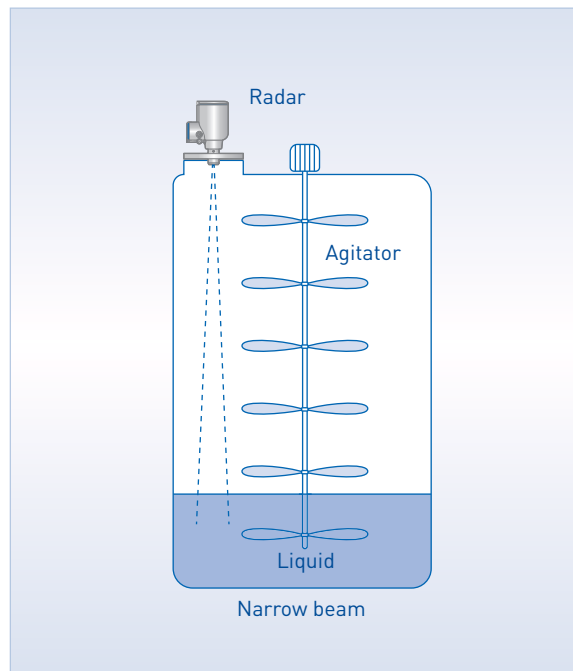

Antennas with small beam width can be installed closer to the tank wall



Antennas with small beam width are ideal to avoid interference reflections from tank internals





Highlights:

- A first-class design that is the result of 28 years of experience in FMCW radar measurement
- Radar devices for liquid, hygienic and solid applications
- Accuracy from $\pm 2 \text{ mm}/\pm 0.08''$
- Lens, Drop and Horn antennas for measuring up to 100 m/328 ft
- Measurement in processes with fast changing levels ($\leq 60 \text{ m/min}/\leq 196.85 \text{ ft/min}$)
- Extensive choice of process connections starting from $3/4''$
- Can measure products with dielectric constants as low as 1.4
- Quick setup assistant for easy commissioning
- Measurement through tank roofs made of non-conductive materials
- Empty tank spectrum function eliminates interference reflections caused by tank internals
- Large backlit LCD display with 4-button keypad
- Text displayed in 12 languages

	For liquids in bypass chambers	For water and wastewater applications	For liquids in storage and process applications	For liquids in basic process applications	For agitated and corrosive liquids
	OPTIWAVE 1010	OPTIWAVE 1400	OPTIWAVE 5200	OPTIWAVE 5400	OPTIWAVE 7400
					
Frequency range	C-band/6 GHz	K-band/24 GHz	X-band/10 GHz	K-band/24 GHz	K-band/24 GHz
Dielectric constant ϵ_r	NA (with float), ≥ 3 (without float)	2	≥ 1.8 (TBF 1.1)	≥ 1.4 (TBF 1.1)	≥ 1.4 (TBF 1.1)
Measuring range	0...8 m/0...26.2 ft	0...20 m/0...65.5 ft	0...30 m/0...98 ft	0...100 m/0...328 ft	0...100 m/0...328 ft
Accuracy	± 5 mm/ ± 0.2 "	± 2 mm/ ± 0.08 " up to 10 m/32.8 ft	± 5 mm/ ± 0.2 "	± 2 mm/ ± 0.08 "	± 2 mm/ ± 0.08 "
Repeatability	± 2 mm/ ± 0.08 "	± 1 mm/ ± 0.04 "	± 1 mm/ ± 0.04 "	± 1 mm/ ± 0.04 "	± 1 mm/ ± 0.04 "
Converter version	C (compact)	C (compact)	C (compact), F (field remote)	C (compact)	C (compact)
Housing material	Aluminum, stainless steel	Stainless steel	Aluminum, stainless steel	Aluminum, stainless steel	Aluminum, stainless steel
Ingress protection	IP66, 67	IP68; NEMA 6P (0.2 barg/2.9 psig for 2 weeks)	IP 66, 67; NEMA 4X	IP66, 68; 0.1 barg/1.45 psig	IP66, 68; 0.1 barg/1.45 psig
Antenna installation*	TLPR*	LPR*	TLPR*	LPR and TLPR*	LPR and TLPR*
Antenna type (material), size (beam angle)	Metallic Horn (316L) $\varnothing 42.4$ mm/1.67" (for BM26 W1010)	Drop (PP) DN80/3" (9°)	Metallic Horn (316L) DN65/2.5" (for BM 26); Metallic Horn (316L) DN80...200/3...8" (32...12°); Wave Horn (PP or PTFE) $\varnothing 43$ mm/1.69" (20°); Metallic Wave Guide (316L) $\varnothing 30$ mm/1.18"	Metallic Horn (316L) DN40...200/1.5...8" (17...5°); Drop (PP) DN80/3" (9°), DN100/4" (7°), DN150/6" (5°)	Metallic Horn (316L) DN40...200/1.5...8" (17...5°); Drop (PEEK) DN80/3" (9°); Drop (PTFE) DN80/3" (8°), DN100/4" (7°), DN150/6" (4°)
Process connection	Welded to bypass chamber or Magnetic Level Indicator (MLI)	Front: thread G 3, 3 NPT Rear: thread G 1, 1 NPT	Thread: G1½, G2, 1½ NPT, 2 NPT; Flange: DN50... 200/2...8", 50...200A	Thread: G1, G1½, 1 NPT, 1½ NPT; Flange: DN40...200/1½...8", 40...200A	Thread: G1, G1½, 1 NPT, 1½ NPT; Flange: DN40...200/1½...8", 40...200A
Gasket	FKM/FPM, EPDM, Kalrez® 6375	-	FKM/FPM, Kalrez® 6375, EPDM, PFA	FKM/FPM, EPDM, Kalrez® 6375	FKM/FPM, EPDM, Kalrez® 6375
Ambient temperature	-40...+85°C/-40...+185°F	-40...+80°C/-40...+176°F	-40...+80°C/-40...+176°F	-40...+80°C/-40...+176°F	-40...+80°C/-40...+176°F
Process temperature	-40...+150°C/-40...+302°F	-40...+80°C/-40...+176°F	-60...+250°C/-76...+482°F (higher on request)	-50...+130°C/-58...+266°F	-50...+200°C/-58...+392°F (higher on request)
Process pressure	-1...40 barg/-14.5...580 psig	-1...3 barg/-14.5...43.5 psig	-1...40 barg/-14.5...580 psig (higher on request)	-1...16 barg/-14.5...232 psig	-1...100 barg/-14.5...1450 psig (higher on request)
Power supply	14.5...30 V DC (Exi), 14.5...36 V DC (Exd)	12...30 V DC	11.5...30 V DC (Exi), 13.5...36 V DC (Exd)	12...30 V DC (Exi), 16...36 V DC (Exd)	12...30 V DC (Exi), 16...36 V DC (Exd)
Output	4...20 mA (HART® 6)	4...20 mA (HART® 7)	4...20 mA (HART® 6), FOUNDATION™ fieldbus, PROFIBUS PA, RS 485 MODBUS RTU**	4...20 mA (HART® 7), FOUNDATION™ fieldbus**, PROFIBUS PA**	4...20 mA (HART® 7), FOUNDATION™ fieldbus**, PROFIBUS PA**
Accessories	Weather protection	Flange, mounting bracket, rear connection nut, cable clamp	Antenna extensions of various shapes and lengths, heating/cooling systems for metallic horn antennas, BM70x adaptor, weather protection	Antenna extensions in metal or PP, purging system, flange plate protection made of PP, weather protection, wall mounted or hanging brackets, low pressure flange disc	Antenna extensions in metal or PTFE, purging/heating/cooling systems for metallic horn antennas, flange plate protection made of PTFE or PEEK, weather protection, OPTIWAVE 7300 process connection adaptor, wall mounted or hanging brackets, low pressure flange disc
Approvals	ATEX, IECEx, NEPSI, NACE	cQPSus general purpose, EAC, CRN, FDA, EU 1934/2004	ATEX, IECEx, cFmus, NEPSI, INMETRO, PESO, EAC, WHG, CRN, NACE	ATEX, IECEx, cQPSus, NEPSI, NACE, EAC**, CRN - ASME B31.3**, PESO**	ATEX, IECEx, cQPSus, NEPSI, NACE, EAC**, WHG**, DNV-GL**, CRN - ASME B31.3**, PESO**
SIL approval	-	-	SIL2	Developed acc. to SIL2/3, IEC 61508 – 2010. The SIL approval is in the process of validation by TÜV Süd, Germany.***	Developed acc. to SIL2/3, IEC 61508 – 2010. The SIL approval is in the process of validation by TÜV Süd, Germany.***

* Antenna installation, ** Available by the end of 2018, *** Available by 2019

LPR (Level Probing Radar): The antenna can be installed in a closed tank as well as outside. The antenna needs to point downwards and location restrictions apply (Radio Astronomy Station). TLPR (Tank Level Probing Radar): The antenna must be installed in a closed tank.

	For liquids in narrow tanks with internal obstructions	For liquids with hygienic requirements	For solids from granulates to rocks	For powders and dusty atmosphere	For liquids in the marine industry
	OPTIWAVE 7500	OPTIWAVE 3500	OPTIWAVE 6400	OPTIWAVE 6500	OPTIWAVE-M 7400
					
Frequency range	W-band/80 GHz	W-band/80 GHz	K-band/24 GHz	W-band/80 GHz	K-band/24 GHz
Dielectric constant ϵ_r	≥ 1.4 (TBF 1.1)	≥ 1.4 (TBF 1.1)	≥ 1.4 (TBF 1.1)	≥ 1.4 (TBF 1.1)	≥ 1.4 (TBF 1.1)
Measuring range	0...100 m/0...328 ft	0...100 m/0...328 ft	0...100 m/0...328 ft	0...100 m/0...328 ft	0.2...50 m/0.7...164 ft
Accuracy	± 2 mm/ ± 0.08 "	± 2 mm/ ± 0.08 "	± 2 mm/ ± 0.08 "	± 2 mm/ ± 0.08 "	± 2 mm/ ± 0.08 "
Repeatability	± 1 mm/ ± 0.04 "	± 1 mm/ ± 0.04 "	± 1 mm/ ± 0.04 "	± 1 mm/ ± 0.04 "	± 1 mm/ ± 0.04 "
Converter version	C (compact)	C (compact)	C (compact)	C (compact)	C (compact)
Housing material	Aluminum, stainless steel	Aluminum, stainless steel	Aluminum, stainless steel	Aluminum, stainless steel	Stainless Steel
Ingress protection	IP66, 68; 0.1 barg/1.45 psig	IP66, 68; 0.1 barg/1.45 psig	IP66, 68; 0.1 barg/1.45 psig	IP66, 68; 0.1 barg/1.45 psig	IP66, 68 0.1 barg/1.45 psig
Antenna installation*	LPR and TLPR*	LPR and TLPR*	LPR*	LPR*	LPR*
Antenna type (material), size (beam angle)	Lens (PEEK) DN20; 3/4" (15°), DN25; 1" (10°), DN40; 1.5" (8°), DN70; 2.75" (4°)	Lens (PEEK) DN25; 1" (10°), DN40; 1.5" (8°)	Metallic Horn (316L) DN80...200; 3...8" (9...5°); Drop (PP) DN80; 3" (9°), DN100 4" (7°), DN150; 6" (5°); Drop (PTFE) DN80; 3" (8°), DN100; 4" (7°), DN150; 6" (4°)	Lens (PEEK) DN40; 1.5" (8°), DN70; 2.75" (4°)	Metallic Horn (316L) DN80/3" (9°), DN100/4" (8°); Drop (PP) DN80/3" (9°) DN100/4" (7°); Drop (PTFE) DN80/3" (8°), DN100/4" (7°)
Process connection	Thread: G3/4, G1, G1½, G3, 3/4 NPT, 1 NPT, 1½ NPT, 3 NPT; Flange: DN50...200; 2...8", 50...200A	Tri-Clamp®: 1½", 2" DIN 11851 or DIN 11864-1 Form A: DN40, DN50 VARIVENT® or NEUMO BioControl®: DN50 SMS 1145: DN51	Thread: G1, G1½, 1 NPT, 1½ NPT; Flange: DN80...200; 3...8", 80...200A	Thread: G1½, G3, 1½ NPT, 3 NPT; Flange: DN50...200; 2...8", 50...200A	Flange: DN100...150; 4...6"
Gasket	FKM/FPM, EPDM, Kalrez®6375	PEEK	FKM/FPM, EPDM, Kalrez® 6375	FKM/FPM, EPDM, Kalrez® 6375	FKM/FPM, Kalrez® 6375, others on request
Ambient temperature	-40...+80°C/-40...+176°F	-40...+80°C/-40...+176°F	-40...+80°C/-40...+176°F	-40...+80°C/-40...+176°F	-40...+80°C/-40...+176°F
Process temperature	-50...+150°C/-58...+302°F, -50...+200°C/-58...+392°F**	-40...+150°C/-40...+302°F	-50...+130°C/-58...+266°F	-50...+150°C/-58...+302°F, -50...+200°C/-58...+392°F**	-50...+200°C/-58...+392°F
Process pressure	-1...40 barg/-14.5...580 psig	-1...25 barg/-14.5...362.6 psig	-1...16 barg/-14.5...232 psig	-1...40 barg/-14.5...580 psig	-1...40 barg/-14.5...580 psig
Power supply	12...30 V DC (Exi), 16...36 V DC (Exd)	12...30 V DC (Exi), 16...36 V DC (Exd)	12...30 V DC (Exi), 16...36 V DC (Exd)	12...30 V DC (Exi), 16...36 V DC (Exd)	12...30 V DC (Exi)
Output	4...20 mA (HART® 7), FOUNDATION™ fieldbus**, PROFIBUS PA**	4...20 mA (HART® 7), FOUNDATION™ fieldbus**, PROFIBUS PA**	4...20 mA (HART® 7), FOUNDATION™ fieldbus**, PROFIBUS PA**	4...20 mA (HART® 7), FOUNDATION™ fieldbus**, PROFIBUS PA**	4...20mA (HART® 7)
Accessories	Antenna extensions in metal, purging system, flange plate protection made of PEEK, weather protection, wall mounted or hanging brackets, low pressure flange disc	Weather protection	Antenna extensions, orientation system, slanted flange, purging system, weather protection, OPTIWAVE 6300 process connection adaptor, wall mounted or hanging brackets, low pressure flange disc	Antenna extensions, orientation system, slanted flange, purging system, weather protection, wall mounted or hanging brackets, low pressure flange disc	Antenna extensions, purging system 1/8 NPT (for metallic horn antenna only), OPTIWAVE 8300 process connection adaptor
Approvals	ATEX, IECEx, cQPSus, NEPSI, NACE, cQPSus, EAC**, DNV-GL**, CRN - ASME B31.3**, PSEO**	ATEX, IECEx, cQPSus, NEPSI, FDA, EC 1935/2004, EC 2023/2006, EU 10/2011, EHEDG, EAC**, CRN-ASME B31.3**, PESO**	ATEX, IECEx, cQPSus (IS), NEPSI, cQPSus (XP/NI)**, EAC**, CRN - ASME B31.3**, PESO**	ATEX, IECEx, cQPSus, NEPSI, EAC**, CRN - ASME B31.3**, PSEO**	ATEX, IECEx Marine approvals: DNV, ABS, GL, LR, BV, CCS, NK, RINA, KR
SIL approval	Developed acc. to SIL2/3, IEC 61508 – 2010. The SIL approval is in the process of validation by TÜV Süd, Germany.***	Developed acc. to SIL2/3, IEC 61508 – 2010. The SIL approval is in the process of validation by TÜV Süd, Germany.***	Developed acc. to SIL2/3, IEC 61508 – 2010. The SIL approval is in the process of validation by TÜV Süd, Germany.***	Developed acc. to SIL2/3, IEC 61508 – 2010. The SIL approval is in the process of validation by TÜV Süd, Germany.***	-



OPTIFLEX 1100
For basic applications
with liquids



OPTIFLEX 3200
For liquids with hygienic
requirements



OPTIFLEX 6200
For solids from granulates
to powders

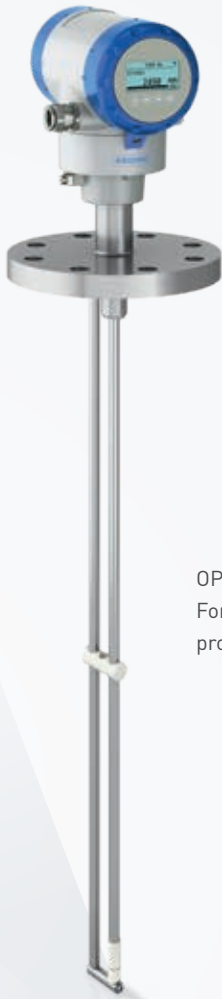

OPTIFLEX 7200
For liquids in storage and
process applications



OPTIFLEX 8200
For liquids at high
temperature and pressure



POWERFLEX 2200
For liquids in the
nuclear industry

Guided radar (TDR) level transmitters

Highlights:

- More than 20 years of experience in TDR technology – first TDR on the market (1996)
- SIL 2/3-compliant according to IEC 61508 for safety-related systems (pending)
- 2-wire 4...20 mA (HART® 7) with second output (current or switch/relay)
- Accuracy from ± 2 mm/ ± 0.08 "
- Interface measurement starting at 50 mm/1.97"
- Large choice of probes to cover all applications
- Double ceramic seal system for dangerous products
- Various converter and electronic versions to facilitate access to the device
- Reversed interface measurement
- FF/PA & HART® communication
- Specific algorithm for low-reflectivity media
- CIP/SIP-suitable hygienic design for level and interface measurement in small vessels

Industries:

- Chemical
- Power Generation
- Water & Wastewater
- Oil & Gas
- Metal & Mining
- Environment
- Food & Beverage
- Pharmaceutical
- Agriculture
- Pulp & Paper

Contact level measurement

TDR guided radar transmitters allow for continuous level measurement of liquids, pastes, granulates, powders and liquid interface in various industries.

With the new OPTIFLEX series, KROHNE offers the appropriate guided radar (TDR) transmitter for each application: The OPTIFLEX 3200 is aimed at hygienic liquid applications in the food, beverage and pharmaceutical markets. The OPTIFLEX 6200 measures solids from granulates to powders. The OPTIFLEX 7200 covers all general liquid applications and the OPTIFLEX 8200 is designed for liquids at high temperature and pressure.

KROHNE has more than 20 years' experience in providing superior TDR level transmitters to its customers.



Guided radar (TDR)

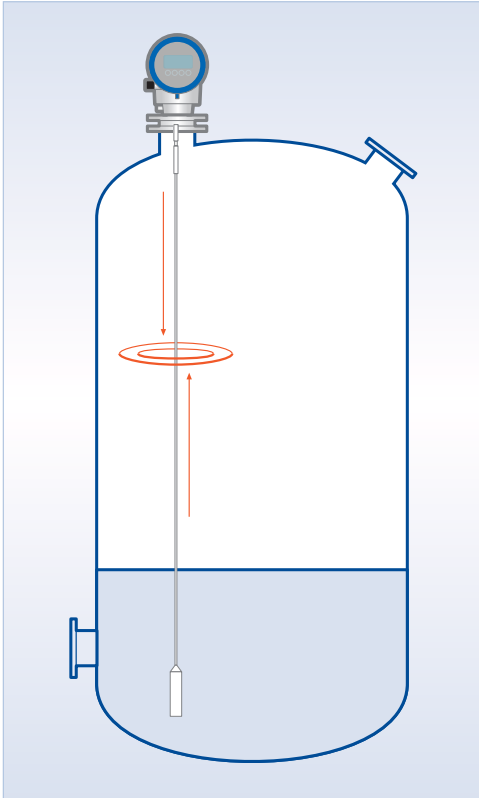

The measuring principle

The guided radar (TDR) level transmitter has been developed from a tried and tested technology called Time Domain Reflectometry (TDR).

The device emits low-intensity electromagnetic pulses of approximately one nanosecond width which are guided along a rigid or flexible conductor. These pulses move at the speed of light. When the pulses reach the surface of the product to be measured, they are reflected with an intensity that depends on the dielectric constant, ϵ_r of the product (e.g., water has a high dielectric constant and the pulse is reflected back to the transmitter at 80 % of its original intensity).

The device measures the time from when the pulse is transmitted to when it is received: half of this time is equivalent to the distance from the reference point of the device (the flange facing) to the surface of the product. The time value is converted into a current output of 4 to 20 mA and/or a digital signal. Dust, foam, vapor, agitated or boiling surfaces, changes in pressure, temperature and density do not have an effect on device performance.

Guided radar (TDR) level meter Pulse shape according to the probe type

Single rod/cable probes



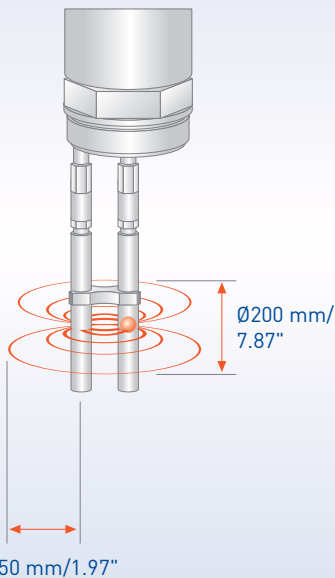

Double rod/cable probes



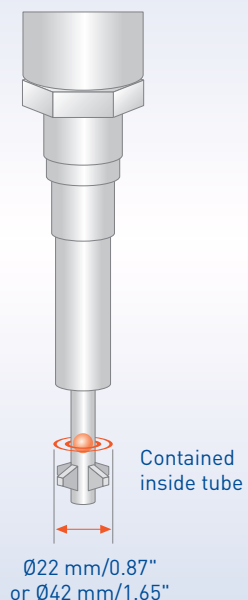

Coaxial probes



Guided radar (TDR) level transmitters

	For basic liquid applications	For liquids in storage and process applications	For liquids at high temperature and pressure
	OPTIFLEX 1100 C	OPTIFLEX 7200 C/F/S/D	OPTIFLEX 8200 C/F/S
			
Dielectric constant ϵ_r	≥ 1.6	≥ 1.3 (TBF 1.1)	≥ 1.3 (TBF 1.1)
Measuring range	0.73...20 m/2.4...65.62 ft	0.3...60 m/0.98...196.85 ft	0.6...60 m/1.97...196.85 ft
Accuracy	± 10 mm/ ± 0.4 "	± 2 mm/ ± 0.08 "	± 2 mm/ ± 0.08 "
Repeatability	± 2 mm/ ± 0.08 "	± 1 mm/ ± 0.04 "	± 1 mm/ ± 0.04 "
Interface detection	no	yes	yes
Converter version	C (compact)	C (compact), F (field remote), S (sensor extension with compact), D (double sensor extension with remote)	C (compact), F (field remote), S (sensor extension with compact)
Housing material	Aluminum	Aluminum, stainless steel	Aluminum, stainless steel
Ingress protection	IP66, 68; NEMA 4X/6P	IP66, 68; NEMA 4X/6P	IP66, 68; NEMA 4X/6P
Probe type (material), size	Single cable (316) $\varnothing 2$ or 4 mm/0.08 or 0.16" Coaxial (316L) $\varnothing 14$ mm/0.55"	Single cable (316/316L or HC22) $\varnothing 4$ mm/0.16" Single cable (316/316L fully TFM-T62 PTFE-coated) $\varnothing 6$ mm/0.55" (pending) Single rod (316L or HC22) $\varnothing 8$ mm/0.32" Single rod (316L fully TFM-T62 PTFE-coated) $\varnothing 10$ mm/0.39" Single rod (316L) $\varnothing 8$ mm/0.32"-segmented Double rod (316L) $\varnothing 8$ mm/0.32" Double cable (316/316L) $\varnothing 4$ mm/0.16" Coaxial (316L or HC22) $\varnothing 22$ mm/0.9" Coaxial (316L) $\varnothing 22$ mm/0.9"-segmented Coaxial (316L or HC22) $\varnothing 42$ mm/1.65" Reversed interface probe (316L or HC22) $\varnothing 10$ mm/3.9"	Single cable (316/316L or HC22) $\varnothing 4$ mm/0.16" Single rod (316L or HC22) $\varnothing 8$ mm/0.32" Single rod (316L) $\varnothing 8$ mm/0.32"-segmented Coaxial (316L or HC22) $\varnothing 42$ mm/1.65"
Process connection	Thread G $\frac{3}{4}$, G 1, $\frac{3}{4}$ NPT, 1 NPT	Thread: G $\frac{3}{4}$...1 $\frac{1}{2}$, $\frac{3}{4}$...1 $\frac{1}{2}$ NPT Flange: DN25...200/1...8"/40...200A	Thread: G 1, 1 NPT Flange: DN25...200/1...8"/40...200A
Gasket	EPDM	FKM/FPM, EPDM, Kalrez® 6375, Kalrez® 7075 (HT version) Single process seal system (Ceramic or PTFE)	FKM/FPM, EPDM, Kalrez® 7075 Single or double process seal system (Ceramic)
Ambient temperature	-40...+80°C/-40...+176°F	-40...+80°C/-40...+176°F	-40...+80°C/-40...+176°F
Process temperature	-50...+100°C/-58...+212°F	-50...+250°C/-58...+482°F	-50...+315°C/-58...+599°F
Process pressure	-1...16 barg/-14.5...232 psig	-1...100 barg/-14.5...1450 psig	-1...320 barg/-14.5...4641 psig
Power supply	14...30 VDC	11.5...30 VDC (Exi), 13.5...34 VDC (Exd)	11.5...30 VDC (Exi), 13.5...34 VDC (Exd)
Output (2-wire)	4...20 mA	4...20 mA passive (HART® 7), 4...20 mA passive (HART® 7) + Second output (4...20 mA or relay), MODBUS RTU*	4...20 mA passive (HART® 7), 4...20 mA passive (HART® 7) + Second output (4...20 mA or relay), MODBUS RTU*
Options and accessories	Weather protection	Dynamic Gas-phase Compensation (DGC), adaptors for previous TDR models, weather protection	Dynamic Gas-phase Compensation (DGC), double ceramic process seal system, leak detection (pending), adaptors for previous TDR models, weather protection
Approvals	CE, EAC	ATEX, IECEx, cQPSus, NEPSI (pending), ASME B31.3, CE, EAC (pending), NACE, NAMUR, SIL (pending)	ATEX, IECEx, cQPSus, NEPSI (pending), ASME B31.3, CE, EAC (pending), NACE, NAMUR, SIL (pending), Steam boiler (pending)

	For liquids with hygienic requirements	For solids from granulates to powders	For liquids in the nuclear industry
	OPTIFLEX 3200 C/F	OPTIFLEX 6200 C/F	POWERFLEX 2200 C/F/S/D
			
Dielectric constant ϵ_r	≥ 1.6 (TBF 1.1)	≥ 1.6 (TBF 1.1)	≥ 1.4
Measuring range	0.6...40 m/1.97...131.23 ft	0.6...40 m/1.97...131.23 ft	0.6...40 m/1.97...131.23 ft
Accuracy	± 2 mm/ ± 0.08 "	± 2 mm/ ± 0.08 "	± 3 mm/ ± 0.12 "
Repeatability	± 1 mm/ ± 0.04 "	± 1 mm/ ± 0.04 "	± 1 mm/ ± 0.04 "
Interface detection	yes	no	no
Converter version	C (compact), F (field remote)	C (compact), F (field remote)	C (compact), F (field remote), S (sensor extension with compact), D (double sensor extension with remote)
Housing material	Aluminum, stainless steel	Aluminum, stainless steel	Stainless steel
Ingress protection	IP66, 68; NEMA 4X/6P	IP66, 68; NEMA 4X/6P	IP66, 68; NEMA 4X/6P
Probe type (material), size	Single cable (316/316L fully TFM-T62 PTFE-coated) Single rod (316L fully TFM-T62 PTFE-coated) $\varnothing 10$ mm/0.39" Single rod (316L polished Ra <0.76 μ m) $\varnothing 8$ mm/0.32"	Single cable (316/316L) $\varnothing 8$ mm/0.32" Single rod (316L) $\varnothing 16$ mm/0.63"	Single cable (316/316L) $\varnothing 4$ mm/0.16" Single rod (316L) $\varnothing 8$ mm/0.32" Double rod (316L) $\varnothing 8$ mm/0.32" Double cable (316/316L) $\varnothing 4$ mm/0.16" Coaxial (316L) $\varnothing 22$ mm/0.9"
Process connection	1" Tri-Clamp ISO 2852 DN25 1 1/2" Tri-Clamp ISO 2852 DN38 2" Tri-Clamp ISO 2852 DN51 DN38 SMS 1145, DN51 SMS 1145 DN25 DIN 11851, DN40 DIN 11851, DN50 DIN 11851	Thread: G 1/2, 1/2 NPT Flange: DN40...200/1 1/2...8"/40...200A	Thread: G 1/2, 1/2 NPT Flange: DN40...200/1 1/2...8"/40...200A
Gasket	FKM/FPM, EPDM, Kalrez® 6221 Single process seal system (PTFE)	FKM/FPM, EPDM, Kalrez® 6375 Single process seal system (PTFE)	EPDM
Ambient temperature	-40...+80°C/-40...+176°F	-40...+80°C/-40...+176°F	-40...+80°C/-40...+176°F
Process temperature	-50...+150°C/-58...+302°F	-50...+200°C/-58...+392°F	-50...+150°C/-58...+302°F
Process pressure	-1...40 barg/-14.5...580 psig	-1...40 barg/-14.5...580 psig	-1...100 barg/-14.5...1450 psig (higher on request)
Power supply	11.5...30 VDC (Exi), 13.5...34 VDC (Exd)	11.5...30 VDC (Exi), 13.5...34 VDC (Exd)	11.5...30 VDC
Output (2-wire)	4...20 mA passive (HART® 7), 4...20 mA passive (HART® 7) + Second output (4...20 mA or relay), MODBUS RTU*	4...20 mA passive (HART® 7), 4...20 mA passive (HART® 7) + Second output (4...20 mA or relay), MODBUS RTU*	4...20 mA HART®
Options and accessories	Weather protection	Adaptors for previous TDR models, weather protection	Weather protection
Approvals	ATEX, IECEx, cQPSus, NEPSI (pending), CE, EAC (pending), FDA, EC, EHEDG, 3A (pending), SIL (pending)	ATEX, IECEx, cQPSus, NEPSI (pending), ASME B31.3, CE, EAC (pending), NACE, NAMUR, SIL (pending)	RCC-E, IEEE, OPB, IEC, RCC-M, ASME, CODAP, EMC, MIL-STD, UL, NFC



BM26A-1000
MLI for basic liquid applications, optional with 6 GHz radar



BM26A-3000
MLI for corrosive liquids



BM26A-5000
Bypass chamber for combination e.g. with radar (FMCW) or guided radar (TDR) level transmitters



BM26A-6000
MLI for liquefied gas



BM26A-7000
MLI for liquids in storage and process applications



BM26A-8000
MLI for liquids at high temperature and pressure

Accessories



LT40
Reed chain



MS15
Level switch for MLI



MS40
Level switch for MLI

Magnetic level indicators (MLI)

Highlights:

- Proven technology with more than 60 years of experience in manufacturing
- Rugged stainless-steel design – low or no maintenance
- Flaps housed in a hermetically sealed glass tube (IP68)
- Highly visible level indication works without power supply
- Large variety of accessories and options: special materials, valves, high and low temperature insulation, hazardous area approvals, limit switches, reed chain, analogue and radar transmitters, interface measurement etc.
- Design for high pressure up to 400 barg/5802 psig design for high temperature up to +450°C/+842°F
- Measuring ranges from 0.3 m/1 ft up to 5.5 m/18 ft (longer on request)
- Bypass chambers which can be equipped with independent transmitters
- Totally redundant measurement by technology and predictive maintenance monitoring possible when equipped with two independent transmitters
- Easy to install, safe and no commissioning
- Accuracy from ± 5 mm/ ± 0.19 " with reed chain

Industries:

- Water & Wastewater
- Chemical
- Metal & Mining
- Power Generation
- Pulp & Paper
- Oil & Gas
- Automotive

Float

The measuring principle

The magnetic level indicator (MLI) operates on the principle of communicating vessels. The measuring chamber is connected adjacent to the tank so that the same conditions are obtained in the chamber as those in the tank. The float is equipped with a system of permanent magnets to transmit measured values to the local indicator. The magnet system of the float activates either the magnetic flaps according to the liquid level, or a movable follower magnet in the indicating section of the indicator depending on the method of indication chosen. The column of reversed yellow magnetic flaps, or the vertical position of the follower magnet, indicates the liquid level.

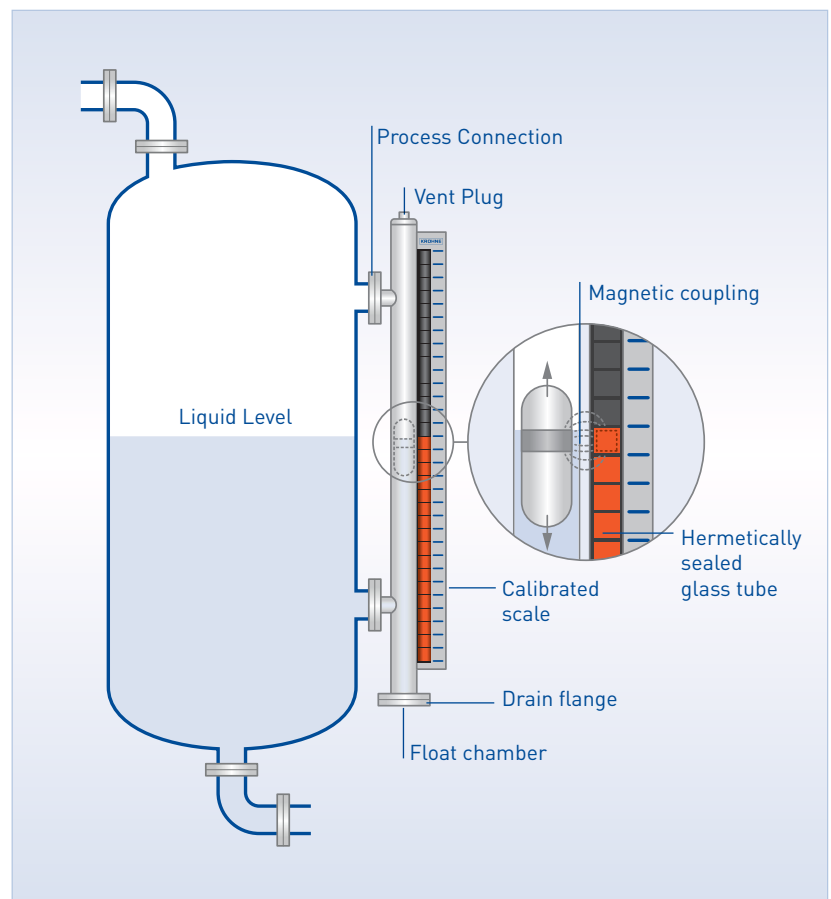

BM26A-1000 & 3000 – Applications up to 40 barg/580 psig & corrosive applications

These magnetic level indicators (MLI) offer the best price/performance ratio within the new range. Their optimal design keeps weight to a minimum. The BM26A-1000 version is ideal for measuring liquids in low-pressure storage and process tanks up to 40 barg/580 psig. The BM26A-3000 uses plastic materials and is ideal for liquids in harsh environments such as tanks containing corrosives with pressures up to 6 barg/87 psig.

BM26A-5000 – Bypass chamber

This series of bypass chambers offers the opportunity to select between 3 different technologies – Radar, TDR and Displacer – to measure level in a variety of difficult conditions: foam, agitated product surfaces and tanks with internal obstructions.

BM26A-6000 & 7000 – General use, liquefied gases & boiler applications

BM26A-6000 & 7000 use the same proven technology as other MLI in the BM 26 range. They are designed for general use but can also reach high temperatures and pressures that make it suitable for boiler applications.

BM26A-8000 – Redundant Measurement





BM26A-8000 combines a standard MLI with an OPTIWAVE 7400 radar (FMCW) or OPTIFLEX 7200 guided radar (TDR) level transmitter and permits totally redundant measurement where the measuring results of the radar transmitter can be checked against those from the magnetic level indicator (MLI). Both technologies operate independently and are not influenced by each other.

By adding an externally-mounted analogue transmitter to these device combinations, equipment condition can be monitored, and a predictive maintenance strategy is possible: maintenance can be planned sufficiently in advance, and at DCS (Distributed Control System) level, by comparing the measuring results of the analogue transmitter with those of the radar transmitter.







Magnetic level indicators (MLI)



	MLI for basic liquid applications	MLI for basic liquid applications with OPTIWAVE 1010 (6 GHz)	MLI for corrosive liquids
	BM26A-1000	BM26A-1000	BM26A-3000
			
Product characteristics	Density: 0.58...2 kg/l	Density: 0.58...2 kg/l	Density: 0.85...2 kg/l
Level/interface	+/+	+/+	+/+
Measuring range	0.3...5.3 m/1...17.4 ft	0.3...5.3 m/1...17.4 ft	0.3...4 m/1...13 ft
Accuracy	±10 mm/0.39" (flappers) ±5 mm/0.2" (LT40 transmitter)	±5 mm/0.2"	±10 mm/0.39" (flappers) ±5 mm/0.2" (LT40 transmitter)
Power supply	LT40: 12...35 V DC	OPTIWAVE: 14.5...30 V DC (Exi), 14.5...36 V DC (Exd)"	LT40: 12...35 V DC
Output (2-wire)	LT40: mA (HART® 6), PROFIBUS® PA, FOUNDATION™ fieldbus"	OPTIWAVE: mA (HART® 6)	LT40: mA (HART® 6), PROFIBUS® PA, FOUNDATION™ fieldbus
Housing material	LT40: aluminum, stainless steel	OPTIWAVE: aluminum, stainless steel	LT40: aluminum, stainless steel
Ambient temperature	-50...+80°C/-58...+176°F	-40...+85°C/-40...+185°F	0...+80°C/+32...+176°F
Protection Category	IP68	IP66, 67	IP68
Thread	G 1/2, G 3/4 1/2 NPT, 3/4 NPT	G 1/2, G 3/4 1/2 NPT, 3/4 NPT	-
EN	DN15...50 PN16...40	DN15...50 PN16...40	DN15...50 PN06-10-16
ASME	1/2...2" 150...300 lb	1/2...2" 150...300 lb	1/2...2" 150 lb
Pressure range			
Process	-1...40 barg/-14.5...580 psig	-1...40 barg/-1...580 psig	-1...6 barg/-1...87 psig
Temperature range			
Process	-50...+300°C/-58...+572°F	-40...+150°C/-40...+302°F	0...+100°C/+32...+212°F
Materials			
Wetted parts	316L, 304L	316L, 304L	PVC, PP or PVDF
Gaskets	Aramid, PTFE, Graphite	Aramid, PTFE, Graphite	FKM/FPM, Nitrile, PTFE, EPDM
Approvals			
Ex	ATEX, IECEx, EAC, NEPSI, cQPUs	ATEX, IECEx, EAC, NEPSI, cQPUs	ATEX, IECEx, EAC, NEPSI, cQPUs
Construction code	PED according to EN13445	PED according to EN13445	-
Miscellaneous	NACE	NACE	-
SIL	-	-	-

	Bypass chamber for OPTIWAVE 5200 (10 GHz)	Bypass chamber for OPTIWAVE 7400 (24 GHz)	Bypass chamber for OPTIFLEX 7200 / 8200	Bypass chamber for BW 25 displacer
	BM26A-5000	BM26A-5000	BM26A-5000	BM26A-5000
				
Product characteristics	Dielectric constant ϵ_r : ≥ 2	Dielectric constant ϵ_r : ≥ 1.4	Dielectric constant ϵ_r : ≥ 1.4	Density 0.45...2 kg/l
Level/interface	+/-	+/-	+/+	+/-
Measuring range	0.3...5.5 m/1...18 ft	0.3...5.5 m/1...18 ft	0.3...5.5 m/1...18 ft	0.3...5.5m/1...18 ft
Accuracy	± 5 mm/0.2"	± 3 mm/0.12"	± 2 mm/0.08 mm	1.5 % of full scale range
Power supply	OPTIWAVE: 11.5...30 V DC (Exi), 13.5...36 V DC (Exd)	OPTIWAVE: 12...30 V DC (Exi), 16...36 V DC (Exd)	OPTIFLEX: 11.5...30 V DC (Exi), 13.5...34 V DC (Exd), 9...34 V DC (Exi-Modbus)	BW: 12...30 V DC
Output (2-wire)	OPTIWAVE: mA (HART® 6), PROFIBUS® PA, FOUNDATION™ fieldbus	OPTIWAVE: mA (HART® 7), PROFIBUS® PA, FOUNDATION™ fieldbus	OPTIFLEX: mA (HART® 7), PROFIBUS® PA, FOUNDATION™ fieldbus	BW: mA (HART® 7), PROFIBUS PA, FOUNDATION™ fieldbus
Housing material	OPTIWAVE: aluminum, stainless steel	OPTIWAVE: aluminum, stainless steel	OPTIFLEX 7200 / 8200: aluminum, stainless steel	BW: aluminum, stainless steel
Ambient temperature	-50...+80°C/-58...+176°F	-50...+80°C/-58...+176°F	-50...+80°C/-58...+176°F	-40...+80°C; -40...+176°F
Protection Category	IP66, 67	IP66, 68	IP66, 67	IP67
Thread	G 1/2, G 3/4, G 1 1/2 NPT, 3/4 NPT, 1 NPT	G 1/2, G 3/4, G 1 1/2 NPT, 3/4 NPT, 1NPT	G 1/2, G 3/4, G 1 1/2 NPT, 3/4 NPT, 1 NPT	G 1/2, G 3/4, G 1 1/2 NPT, 3/4 NPT, 1 NPT
EN	DN15...50 PN16...250	DN15...50 PN16...250	DN15...50 PN16...250	DN15...50 PN16...250
ASME	1/2...2" 150...2500 lb	1/2...2" 150...2500 lb	1/2...2" 150...2500 lb	1/2...2" 150...2500 lb
Pressure range				
Process	-1...40 barg/-14.5...580 psig	-1...100 barg/-1...1450 psig	-1...320 barg/-14.5...4641 psig	-1...400 barg; -14.5...5801 psig
Temperature range				
Process	-50...+250°C/-58...+482°F	-50...+200°C/-58...+392°F	-50...+315°C/-58...+599°F	-40...+400°C/-40...+752°F
Materials				
Wetted parts	PTFE, 316L, Hastelloy® on request: 304L, Inconel 625	PTFE, 316L, Hastelloy® on request: 304L, Inconel 625	PTFE, 316L, Hastelloy® on request: 304L, Inconel 625	316L on request: 304L, Hastelloy®, Inconel 625
Gaskets	Aramid, PTFE, Graphite, Ring joint	Aramid, PTFE, Graphite, Ring joint	Aramid, PTFE, Graphite, Ring joint	Aramid, PTFE, Graphite, Ring joint
Approvals				
Ex	-	-	-	-
Construction code	PED according to EN13445	PED according to EN13445	PED according to EN13445	PED according to EN13445
Miscellaneous	NACE	NACE	NACE	NACE
SIL	SIL2	SIL2/3	SIL2/3	SIL2

Magnetic level indicators (MLI)

	MLI for liquefied gas	MLI for liquids in storage and process applications	MLI for liquids at high temperature and pressure	MLI for liquids at high temperature and pressure
	BM26A-6000	BM26A-7000	BM26A-8000-BI	BM26A-8000-TWIN
				
Product characteristics	Density 0.62...1.2 kg/l	Density 0.37...2.0 kg/l	Density 0.58...1.2 kg/l	Density 0.37...1.2 kg/l
Level/interface	+/+	+/+	+/+	+/+
Measuring range	0.3...5.5m/1...18 ft	0.3...5.5 m/1...18 ft	0.3...5.5 m /1...18 ft	0.3...5.5m/1...18 ft
Accuracy	±10 mm/0.39" (flappers) ±5 mm/0.2" (LT40 transmitter)	±10 mm/0.39" (flappers) ±5 mm/0.2" (LT40 transmitter)	±10 mm/0.39" (flappers) ±5 mm/0.2" (LT40 transmitter) ±3 mm/0.12" (TDR transmitter)	±10 mm/0.39" (flappers) ±5 mm/0.2" (LT40 transmitter) ±3 mm/0.12" (TDR transmitter)
Power supply	LT40: 12...35 V DC	LT40: 12...35 V DC	LT40: 12...35 V DC OPTIFLEX: 11.5...30 V DC (Exi), 13.5...34 V DC (Exd), 9...34 V DC (Exi-Modbus)	LT40: 12...35 V DC OPTIFLEX: 11.5...30 V DC (Exi), 13.5...34 V DC (Exd), 9...34 V DC (Exi-Modbus) OPTIWAVE: 12...30 V DC (Exi), 16...36 V DC (Exd)
Output (2-wire)	LT40: mA (HART® 6), PROFIBUS® PA, FOUNDATION™ fieldbus	LT40: mA (HART® 6), PROFIBUS® PA, FOUNDATION™ fieldbus	LT40, OPTIFLEX: mA (HART®), PROFIBUS® PA, FOUNDATION™ fieldbus	LT40, OPTIFLEX, OPTIWAVE, BW: mA (HART®), PROFIBUS® PA, FOUNDATION™ fieldbus
Housing material	LT40: aluminium, stainless steel	LT40: aluminum, stainless steel	LT40, OPTIFLEX: aluminum, stainless steel	LT40, OPTIFLEX, OPTIWAVE, BW: aluminum, stainless steel
Ambient temperature	-50...+80°C/-58...+176°F	-50...+80°C/-58...+176°F	-50...+80°C/-58...+176°F	-50...+80°C/-58...+176°F
Protection Category	IP68	IP68	LT40: IP67 OPTIFLEX: IP66, 67	LT40: IP67 OPTIFLEX: IP66, 67 OPTIWAVE: IP66, 68 BW: IP67
Thread	G 1/2, G 3/4, G 1 1/2 NPT, 3/4 NPT, 1 NPT	G 1/2, G 3/4, G 1 1/2 NPT, 3/4 NPT, 1 NPT	G 1/2, G 3/4, G 1 1/2 NPT, 3/4 NPT, 1 NPT	G 1/2, G 3/4, G 1 1/2 NPT, 3/4 NPT, 1 NPT
EN	DN15...50 PN16...250	DN15...50 PN16...250	DN15...50 PN16...250	DN15...50 PN16...250
ASME	1/2...2" 150...2500 lb	1/2...2" 150...2500 lb	1/2...2" 150...2500 lb	1/2...2" 150...2500 lb
Pressure range				
Process	-1...40 barg/-14.5...580 psig	-1...400 barg/-14.5...5801 psig	-1...40 barg/-14.5...580 psig	-1...400 barg/-14.5...5801 psig
Temperature range				
Process	-60...+300°C/-76...+572°F	-196...+400°C/-321...+752°F	-50...+315°C/-58...+599°F	-50...+315°C/-58...+599°F
Materials				
Wetted parts	316L, 304L Hastelloy® C276, Inconel 625	316L, 304L Hastelloy® C276, Inconel 625 PTFE lining	316L, 304L Hastelloy® C276, Inconel 625, PTFE, PEEK	316L, 304L Hastelloy® C276, Inconel 625, PTFE, PEEK
Gaskets	Aramid, PTFE, Graphite, Ring joint	Aramid, PTFE, Graphite, Ring joint	Aramid, PTFE, Graphite, Ring joint	Aramid, PTFE, Graphite, Ring joint
Approvals				
Ex	ATEX, IECEX, EAC, NEPSI, cQPUs	ATEX, IECEX, EAC, NEPSI, cQPUs	ATEX, IECEX, EAC, NEPSI, cQPUs	ATEX, IECEX, EAC, NEPSI, cQPUs
Construction code	PED according to EN13445 ASME B31.3 ASME VIII div 1	PED according to EN13445 ASME B31.3 ASME VIII div 1	PED according to EN13445 ASME B31.3 ASME VIII div 1	PED according to EN13445 ASME B31.3 ASME VIII div 1
Miscellaneous	NACE	NACE	NACE	NACE
SIL	SIL1	SIL1	SIL2/3	SIL2/3

Accessories for magnetic level indicators (MLI)

	Reed chain	Level switch	Level switch
	LT40	MS15	MS40
			
Product characteristics	According BM26A limits	According BM26A limits	According BM26A limits
Level/interface	+/+	+/+	+/+
Measuring range	0.3...5.5 m/1...18 ft	-	-
Accuracy	±5 mm/0.2"	-	-
Power supply	12...35 V DC	60VA/1A/250 V AC	60VA/1A/250 V AC
Output (2-wire)	mA [HART®], PROFIBUS® PA, FOUNDATION™ fieldbus	Relay, SPDT 3-wire output, NAMUR	Relay, SPDT 3-wire output, NAMUR
Housing material	Aluminum, stainless steel	Aluminum, stainless steel	Aluminum
Ambient temperature	-50...+80°C/-58...+176°F	-60...+125°C/-76...+257°F	-50...+125°C/-58...+257°F
Protection Category	IP68	IP68	IP66
Thread	-	-	-
EN	-	-	-
ASME	-	-	-
Pressure range			
Process	-	-	-
Temperature range			
Process	-	-	-
Materials			
Wetted parts	-	-	-
Gaskets	-	-	-
Approvals			
Ex	ATEX, IECEx, EAC, NEPSI, cQPUs	ATEX, IECEx, EAC, NEPSI, cQPUs	ATEX, IECEx, EAC, NEPSI, cQPUs
Construction code	-	-	-
Miscellaneous	-	NAMUR	NAMUR
SIL	-	SIL1	-



OPTISOUND 3010 C
For small vessels



OPTISOUND 3020 C
For small and medium-sized vessels



OPTISOUND 3030 C
For medium-sized vessels

Ultrasonic level transmitters



BW 25
Displacer level transmitter
for high pressures and
temperatures



BM 500
Potentiometric level
transmitter for hygienic
applications

Displacer and Potentiometric level transmitters

Ultrasonic

Highlights:

- Continuous level measurement of liquids and solids
- Suitable for sumps, water and wastewater basins
- Non-contact flow measurement and detection in open channels
- Level detection of solids in silos and storage tanks
- Level measurement in stone crushers
- Profile measurement on conveyor belts

The measuring principle

Short ultrasonic pulses in the range of 18 to 70 kHz are sent from the signal transducer to the product to be measured. They are reflected off the product surface and received again by the transducer. The pulses propagate at the speed of sound, where the time between the sending and receiving of the signals depends on the level in the tank. The latest microprocessor technology and the tried and tested analysis software ensure that you will be able to reliably determine the level echo even when interference reflections are present and to calculate the exact distance to the surface of the fill goods. To compensate for the duration of the acoustic signal, an integrated sensor detects the temperature in the tank.

A level-proportional signal is formed from the distance by simply inputting the tank dimensions. It is not necessary to fill the tank for the adjustment.

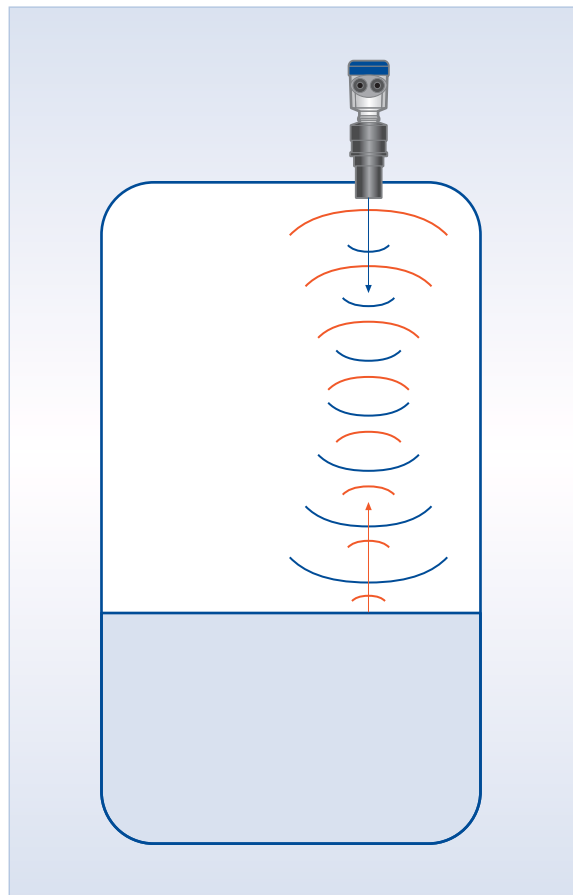



OPTISOUND – The ultrasonic for liquids and solids

The OPTISOUND ultrasonic level transmitters are used for continuous level measurement of liquids and solids in nearly all sectors of industry.

They are ideal for non-contact flow measurement and detection in open channels. OPTISOUND are also used for continuous level measurement in process and storage tanks, in basins, wastewater tanks or on conveyor belts.

Being able to detect a certain percentage of solids in liquids, these transmitters are also suitable for rain- and wastewater with low or high degrees of contamination (e.g. silting).

Bulk solids naturally pose different challenges to a transmitter than do liquids. The surface of solids is not smooth, but generally forms a cone.

Many products cause a heavy dust build-up. In addition, most solid silos are taller than the tanks for liquids. In this case too, OPTISOUND provides reliable measuring values.

By means of differently adjusted transmitting frequencies, the device can measure levels from 0.25 to 15 m/0.82 to 49.2 ft for liquids, from 0.25 to 7 m/0.82 to 23 ft for solids.

Highly resistant materials for the acoustic signal transducers and process connections guarantee the use of OPTISOUND even with caustic media. An optional mounting bracket enables easy alignment of the sensor.

Industries:

- Water & Wastewater
- Chemical
- Metal & Mining
- Power Generation
- Pulp & Paper



OPTISOUND 3020 C

Displacer

Highlights:

- Suitable for use under extreme process conditions
- Resistant to temperatures ranging from -60 to $+400^{\circ}\text{C}$ / -76 to $+752^{\circ}\text{F}$ and pressures up to 400 barg/5800 psig
- Level and interface measurement
- Modular design, which makes retrofitting possible without interrupting the process
- Pressure-proof isolation of the measuring and displaying room

The measuring principle

The BW 25 level indicator works according to the displacer principle. In this principle, the length of the displacement element rod corresponds to the measuring range. The body, which is suspended on a measuring spring, is immersed in the liquid where it determines the lifting force that is proportional to the displaced mass of the liquid (Archimedean principle). Any change to the weight of the rod corresponds to a change in the length of the spring and is therefore a measure of the level. The extension of the length of the spring, and thereby the measuring stroke, are transmitted to the display.

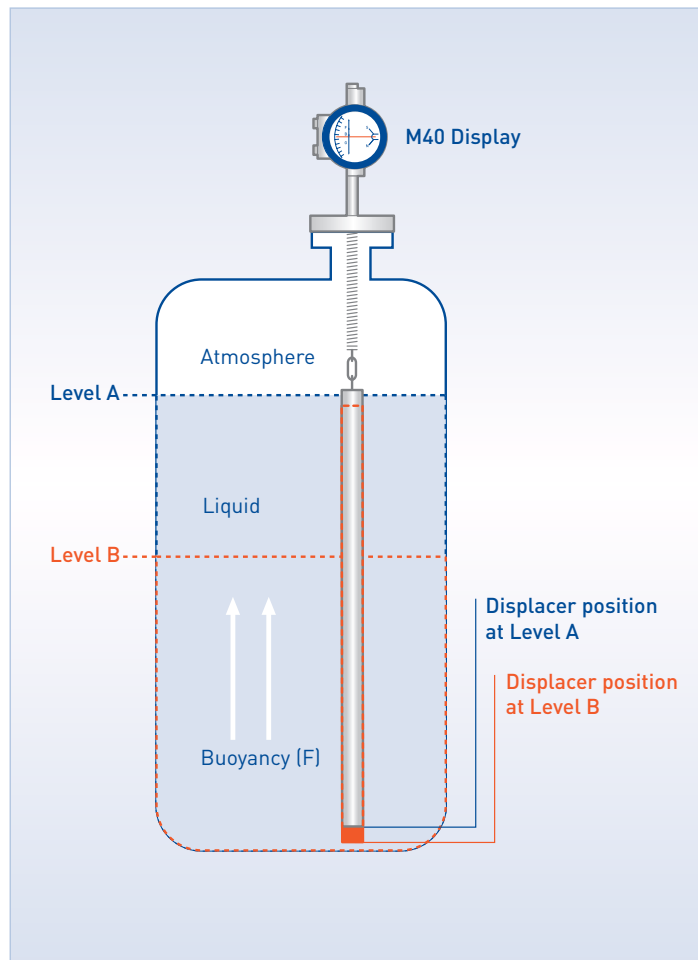

Industries:

- Petrochemical
- Chemical
- Power Generation



BW 25 – Sovereign even under extreme process conditions

The BW 25 is a true all-rounder for measuring level or interface of various liquids under extreme process conditions.

It can deal with corrosive media, high temperatures (up to +400°C/+752°F) and high pressures (up to 400 barg/5800 psig). Retrofitting the converter and adding switches to the device is possible without interrupting the process. The BW 25 can also be installed in a bypass chamber e.g. applications with agitators.



BW 25 with M40 display

Potentiometric

Highlights:

- Measurement independent of media properties
- Not sensitive to adhesives and foam
- Up to 3 m/9.8 ft probe length
- Defined empty reporting function
- Potted design
- Quick response time
- Automatic position detection
- Level measurement beyond 50 mm/97"
- High temperature resistance (+140°C/+284°F)
- Remote version available

The measuring principle

The BM 500 level transmitter works according to the potentiometric measuring principle and can only be used with a minimum conductivity of 50 $\mu\text{S}/\text{cm}$ for all electrically conductive media (e.g. pure water).

The level probe (sensor) consists of a low-resistance measuring tube, which is immersed in an electrically conductive liquid. An AC generator runs a higher frequency current through the measuring tube. A voltage is taken from between the probe and the tank wall and sent to an amplifier. In homogeneous conditions in the medium, this is proportional to the level.

The potentiometric measuring method is particularly suitable for measuring levels in small vessels containing viscous, pasty or strongly adhesive media. The electronic evaluation unit is integrated in the signal converter and supplies a level-proportional output signal of 4 to 20 mA.

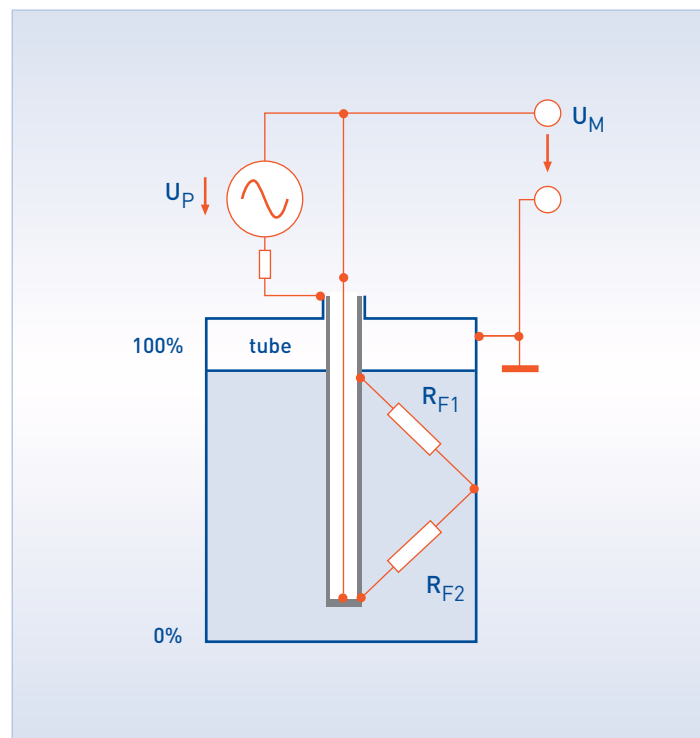

Industries:

- Food & Beverage
- Pharmaceutical

BM 500 – The hygienic transmitter for conductive media

Whether you are dealing with fruit juice, ketchup, beer, toothpaste or mustard: for viscous, pasty or highly adhesive media, the BM 500 level transmitter is the first choice.

Especially in small tanks, the potentiometric measuring technology makes full use of its advantages. Thus, the BM 500 already measures starting at a level of 50 mm/1.97" and wins you over with its fast response time.



A large choice of hygienic process connections and high temperature resistance (Clean-in-Place and Sterilization-in-Place processes) make it the ideal potentiometric level transmitter for the food, beverage and pharmaceutical industry.



Ultrasonic level transmitters

	For small vessels	For small and medium-sized vessels	For medium-sized vessels
	OPTISOUND 3010 C	OPTISOUND 3020 C	OPTISOUND 3030 C
			
Frequency range	70 kHz	55 kHz	35 kHz
Measurable products	Liquids and solids	Liquids and solids	Liquids and solids
Level/interface	+/-	+/-	+/-
Measuring range	Liquids: 0.25...5 m/0.82...16.4 ft Solids: 0.25...2 m/0.82...6.6 ft	Liquids: 0.4...8 m/3...26.2 ft Solids: 0.4...3.5 m/1.3...11.5 ft	Liquids: 0.6...15 m/2...49 ft Solids: 0.6...7 m/2...23 ft
Dielectric constant ϵ_r	-	-	-
Accuracy	± 4 mm/ ± 0.16 "	± 6 mm/ ± 0.24 "	± 6 mm/ ± 0.24 "
Outputs	mA (HART®)	mA (HART®)	mA (HART®)
Power supply	2-wire: 14...36 V DC (14...30 V DC Ex i) 4-wire: 20...72 V DC, 20...253 V AC	2-wire: 14...36 V DC (14...30 V DC Ex i) 4-wire: 20...72 V DC, 20...253 V AC	2-wire: 14...36 V DC (14...30 V DC Ex i) 4-wire: 20...72 V DC, 20...253 V AC
Housing material	Plastic, aluminum, stainless steel	Plastic, aluminum, stainless steel	Plastic, aluminum, stainless steel
Ambient temperature	-40...+80°C/-40...+176°F	-40...+80°C/-40...+176°F	-40...+80°C/-40...+176°F
Protection category	IP66, 67; NEMA4, 4X, 6	IP66, 67; NEMA4, 4X, 6	IP66, 67; NEMA4, 4X, 6
Flange system			
Process connection			
Thread	G 1½; 1½ NPT others on request	G2; 2 NPT others on request	-
EN	On request	On request	Compression flange DN100, others on request
ASME	On request	On request	Compression flange 4" 150 lbs
Pressure range			
Process	-0.2...2 barg/-2.9...29 psig	-0.2...2 barg/-2.9...29 psig	-0.2...1 barg/-2.9...14.5 psig
Temperature range			
Process	-40...+80°C/-40...+176°F	-40...+80°C/-40...+176°F	-40...+80°C/-40...+176°F
Materials			
Wetted parts	PVDF	PVDF	1.4301, UP, 1.4571 (316 Ti)
Gaskets	EPDM	EPDM	EPDM
Approvals			
Ex	ATEX, EAC	ATEX, EAC	-
Miscellaneous	-	-	EAC

Displacer and Potentiometric level transmitters

	Displacer level transmitter for high pressures and temperatures	Potentiometric level transmitter for hygienic applications
	BW 25	BM 500
		
Measuring principle	Displacer	Potentiometric
Measurable products	Liquids	Liquids and pastes
Level/Interface	+/+	+/-
Measuring range	0.3...5.5 m/1...18 ft, longer devices on request	0.2...3 m/0.7...10 ft
Product characteristics	Density: $\geq 0.45 \text{ kg/l}$ / $\geq 28.09 \text{ lb/ft}^3$	Electrical conductivity: $\geq 50 \text{ }\mu\text{s/cm}$
Accuracy	<1.5% full scale value	$\pm 0.5\%$
Outputs	mA (HART®) switching outputs	mA
Power supply	12...30 V DC	4-wire: 18...36 V DC (non-Ex)
Housing material	Aluminum, stainless steel	Stainless steel
Ambient temperature	-40...+60°C/-40...+140°F	-20...+60°C/-4...+140°F (compact) -20...+100°C/-4...+212°F (remote)
Protection category	IP67; NEMA4X	IP67; NEMA4X
Flange system		
Process connection		
Thread	On request	G1 hygienic via adapter system
EN	DN50...100 in PN16...400	-
ASME	2...4" in 150...2500 lb	-
Pressure range		
Process	-1...400 barg/-14.5...5800 psig, others on request	-1...16 barg/-14.5...232 psig
Temperature range		
Process	-40...+400°C/-40...+752°F	-20...+140°C/-4...+284°F
Materials		
Wetted parts	Stainless steel 1.4404 (316L), others on request	Stainless steel 1.4404 (316L)
Gaskets	-	-
Approvals		
Ex	ATEX, EAC	-
Miscellaneous	NACE	3A / FDA, EAC

Pressure transmitters



OPTIBAR P 2010
For hygienic applications, with
flush metallic diaphragm



OPTIBAR PM 3050
For standard applications, with
recessed stainless steel diaphragm
and optional display module



OPTIBAR PC 5060
For advanced applications, with
corrosion and abrasion resistant
ceramic diaphragm



OPTIBAR PM 5060
With fully welded metallic
diaphragm for high pressure
ranges and hygienic requirements



OPTIBAR DP 7060
Differential pressure transmitter
for hydrostatic level measurement
with integrated absolute pressure
measurement

Submersible probes



OPTIBAR LC 1010
Submersible level probe with
ceramic diaphragm 22 mm /1"
diameter

Diaphragm seals

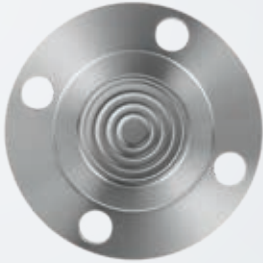

OPTIBAR DS series
Diaphragm seals for temperatures up to +400 °C /752 F for corrosive mediums



OPTIBAR DSD 3100
Direct attachment to OPTIBAR DP 7060



OPTIBAR DSD 3110
Capillary tube attachment to OPTIBAR DP 7060



OPTIBAR DSD 3210
Direct and capillary tube attachment to OPTIBAR DP 7060



OPTIBAR DSD 3220
2x Direct and capillary tube attachment to OPTIBAR DP 7060



OPTIBAR DSP 2000
Diaphragm seals for special applications with threaded or open connection for OPTIBAR PM series



OPTIBAR DSP 3000
Flangetype diaphragm seals for OPTIBAR PM series

Hydrostatic level measurement



Pressure

Pressure transmitters are commonly used for liquid level measurement applications. The reason for their wide spread application lies especially in the ease to install and use, their robustness in the application and their wide range of application conditions.

For level measurements in open or vented vessels, a gauge pressure or differential pressure transmitter can be used. In closed and pressurized vessels, a differential pressure measurement by a classical DP transmitter or an electronic DP system is required to compensate for the gas pressure.

Besides basic level measurements, differential pressure transmitters can be also used to measure the density or interface positions of fluids.

The OPTIBAR pressure instrumentation series offer pressure and differential pressure transmitter with metallic or ceramic diaphragms for all industry segments. Advanced diagnostics and communication protocols, easy to use software and if required engineered combinations with our OPTIBAR DS diaphragm seal series assure a perfect application fit.

In addition to the pressure transmitter series, our OPTIBAR submersible level probes are suitable for basic hydrostatic level applications in wells or tanks in water and wastewater applications.

Highlights:

- Applicable for nearly any liquid or slurry
- Process temperatures up to 400 °C/752 °F
- Process pressure up to 400 bar/5801 psi
- Not affected by process conditions: dust, foam, vapor, agitation, boiling or bubbles
- Process connections for all applications – also 3A and EHEDG approved hygienic connections
- Hydrostatic level measurement with automatic density compensation
- Thermal shock compensation



Technology Icon “Ceramic durability”

- Most robust diaphragm material on the market
- Extremely high overload and vacuum resistance
- Diaphragm breakage detection



Technology Icon “3D-Linearisation”

- Integrated absolute pressure sensor (DP + Pabs)
- Fully compensated in three dimensions (DP + Pabs + T)
- Predictable robust under all process conditions

Hydrostatic level measurement in open or vented vessels

The measuring principle

In an open or vented vessel, the inside pressure is equal to the actual atmospheric pressure at its location. A column of liquid exerts a certain force on the base of the vessel by its own weight. A change in liquid column height causes a proportional change of force, also called hydrostatic pressure.

Using Pascal's law, the height of the liquid level can be calculated from the hydrostatic pressure P , the gravity acceleration g and the liquid density ρ .

$$P = \rho \times g \times h$$

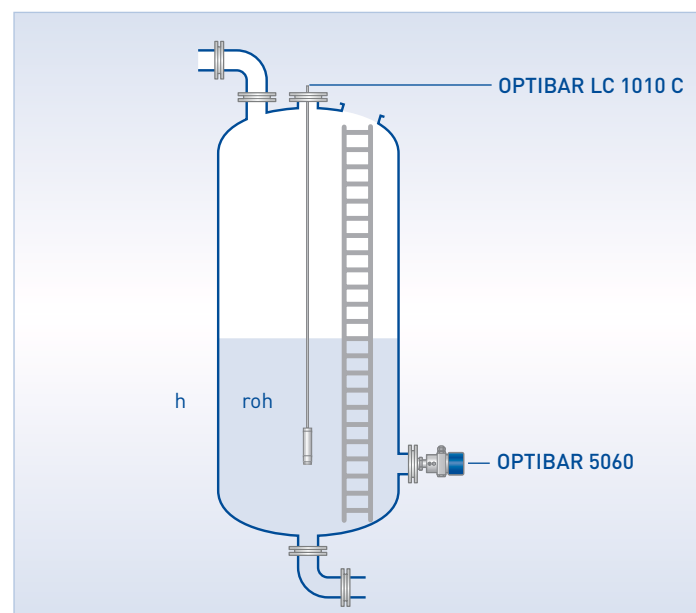

There are several OPTIBAR gauge pressure transmitters for open or vented vessels applications available:

- Entry level ultra-compact series OPTIBAR P 2010 with metallic front flush diaphragm
- Compact OPTIBAR PM 3050 and advanced process OPTIBAR PM 5060 with fully welded metallic diaphragms, also for aseptic processes.
- Process pressure transmitter OPTIBAR PC 5060 with "ceramic durability" in demanding applications for measuring ranges down to 0.25 m/10" water column.
- Differential pressure transmitter OPTIBAR DP 7060 one-sided connected with impulse piping or OPTIBAR DS series diaphragm seals.

Hydrostatic level measurement in closed or pressurised vessels

The measuring principle

Contrary to open or vented vessels, a gauge pressure transmitter will not perform in a closed or pressurised vessel application, since it cannot distinguish between a change of liquid level or of the pressure inside the vessel by itself.

In order to handle this type of application, a differential pressure measurement is necessary. The high pressure tap is usually located at the bottom of the vessel to measure the liquid level column plus the gas pressure on top of it. The low pressure tap is connected on the very top of the vessel to measure the gas pressure alone. The resulting pressure difference between the two taps is the hydrostatic pressure of the liquid level column inside.

The following formula is based on Pascal's Law of hydrostatic pressure, extended by the different densities of the gas phase and the fluid inside the depicted capillaries.

$$P_{\text{level}} = P_2 - P_1$$

A differential pressure measurement can be made by a single DP transmitter which is connected by impulse piping or by diaphragm seals to the vessel. Alternatively, a so called electronic DP transmitter uses two discrete gauge pressure transmitters to calculate the difference electronically.

Differential pressure transmitters for closed or pressurised vessels:

- OPTIBAR DP 7060 differential pressure transmitter for pressurised vessels up to 400 bar/5800 psi – predictable robust measurements with 3D-linearization technology.
- OPTIBAR DS series – full series of diaphragm seals with more than 10+ wetted materials to choose from.
- OPTIBAR 5060 series – advanced electronic differential pressure with metallic or ceramic technology up to 150°C

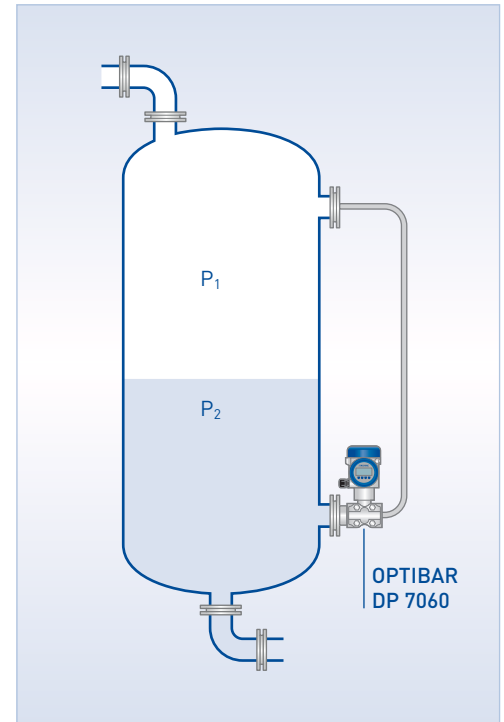

Industries:

- Oil & Gas
- Chemical
- Power Generation
- Food & Beverage
- Metal & Mining

Electronic Differential Pressure

Electronic differential pressure presents in some applications a great alternative to the use of classical differential pressure transmitters.

The measuring principle is based on two discrete gauge pressure transmitters, which are mounted in the same way as a classical differential pressure transmitter on the vessel. One transmitter, usually the one on the top, acts as so called SLAVE transmitter to measure the gas pressure in the tank. This SLAVE is electronically connected to the MASTER transmitter. This MASTER measures now the gauge pressure on the very bottom of the vessel and performs the calculation of the pressure difference in between.

$$P_{\text{slave}} = P_g$$

$$P_{\text{master}} = \rho \cdot L \cdot g \cdot h + P_g$$

$$P_{\text{level}} = P_{\text{master}} - P_{\text{slave}}$$

In this electronic DP configuration of the OPTIBAR 5060 series, the SLAVE sensor provides fast and synchronous measurement values to the MASTER, which acts and behaves like a classical DP transmitter in terms of setup and commissioning.

The advantages of an eDP lies especially in the efficient connection with the vessel. Smaller process connections without capillaries with a maximum distance of up to 25 m/75 ft between the top and the bottom tap, save cost and installation time. The electronic DP loses its edge in applications with higher gas pressures over a classical DP.

Density Compensation

Hydrostatic level applications are require generally stable density values to maintain the overall accuracy. An electronic DP configuration in combination with an open or vented vessel allows to perform an automatic density compensation. In that function, the slave transmitter will be placed on purpose in a position, where it is being covered by at least 1m / 3ft of liquid. The converter electronics will then perform all necessary calculations internally.



OPTIBAR 5060 series in electronic DP configuration

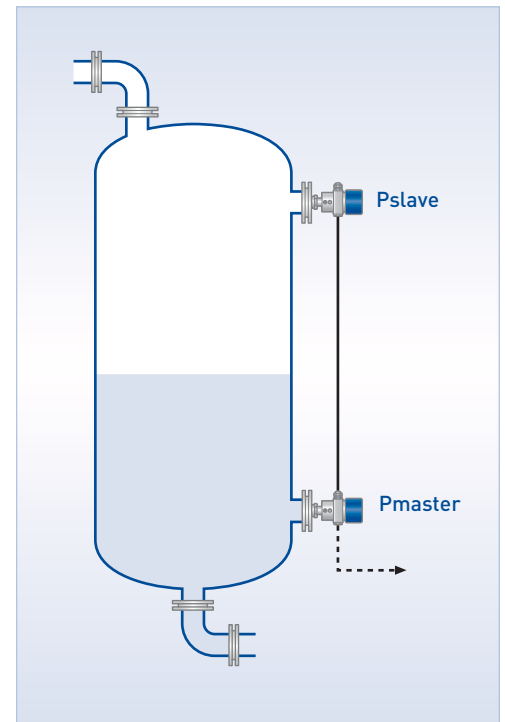

Highlights:

- Small process connections
- Mounting distance up to 25 m/75 ft with response times < 125 ms
- Almost no influence by ambient temperature changes
- Up to 400 °C process temperature in combination with OPTIBAR DS series
- with SIL 2/3 certification
- available with 4..20 mA/HART®; FF and PROFIBUS® PA
- Automatic density compensation (open vessels only)

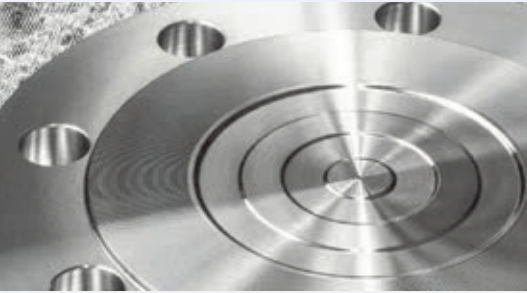

Diaphragm Materials:

- 316L
- Duplex Steel
- Tantalum
- Titanium
- Hastelloy® C-276
- Monel 400

Coated:

- Gold
- PFA
- PTFE (up to 200 °C full vacuum rated)
- ECTFE (HALAR)
- Rubber

OPTIBAR DS Series Diaphragm Seals

Some applications require a separating diaphragm between the pressure or differential pressure transmitter and the process. Elevated process temperatures, heavy vibration, corrosive fluids or aseptic requirements make the number of use cases for the OPTIBAR DS series uncountable.

A diaphragm seal transmits the applied pressure hydraulically via a fill fluid to the pressure sensor. The OPTIBAR DSP program is specifically designed for KROHNE pressure transmitters OPTIBAR PM 3050 and OPTIBAR PM 5060, whereas the differential pressure transmitters OPTIBAR DP 7060 perfectly harmonize with the OPTIBAR DSD program. Only a specifically engineered and optimized system, guarantees low temperature effects and fast response times.

The OPTIBAR DS series offers the following wetted materials as standard for many process connection standards:

Diaphragm seal system schematic

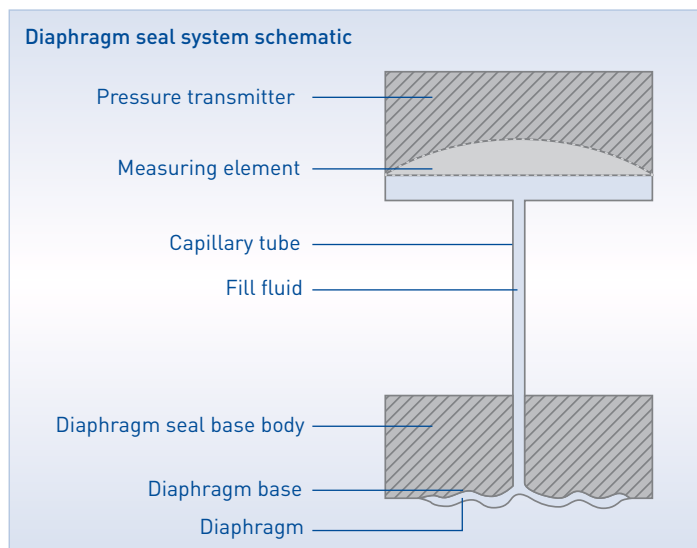

The fill fluid is next to the right material selection a crucial component for a diaphragm seal. The OPTIBAR DS series can always offer the right choice for the application. Vacuum conditions can have a severe effect on the diaphragm seal system over time. KROHNE offers for every fill fluid a chart that determines the minimal process pressure at a given process temperature.

- Silicon oil
- Silicon free oil with FDA approval
- Halocarbon oil for Oxygen applications
- Water / Alcohol
- Water / Glycol

Vacuum resistance chart

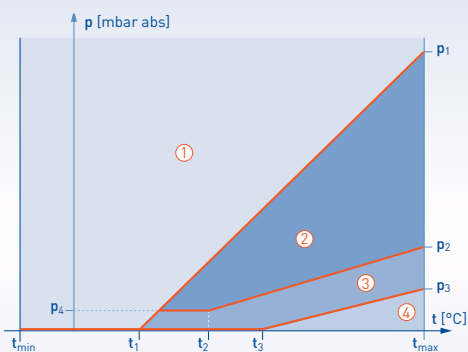

- ① Standard service
- ② Low pressure service
- ③ Vacuum service
- ④ Requires engineering support

OPTIBAR Submersible Level Probes

Submersible level probes are ideally suited for hydrostatic level applications of open wells and underground basins.

The measuring principle

In an open vessel, the inside pressure is equal to the actual atmospheric pressure at its location. A column of liquid exerts a certain force on the base of the vessel by its own weight.

A change in liquid column height causes a proportional change of force, also called hydrostatic pressure.

Using Pascal's law, the height of the liquid level can be calculated from the hydrostatic pressure P , the gravity acceleration g and the liquid density ρ .

$$P = \rho \times g \times a$$



OPTIBAR LC 1010

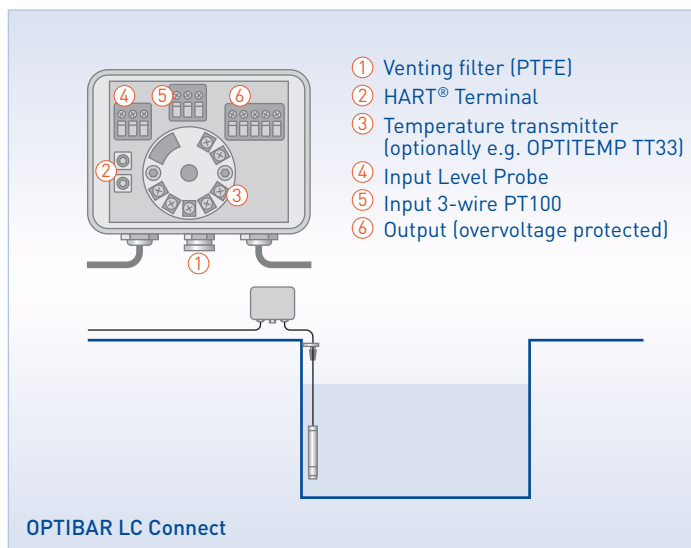







The ceramic measuring cell of the OPTIBAR LC 1010 offers a high overload and corrosion resistance and the ability to be cleaned frequently, if the application demands for it.

OPTIBAR LC Connect



An optional temperature transmitter, lightning protection, a HART® connection terminal, as well as the Gore-Tex vent makes this OPTIBAR LC Connect junction box perfectly suited for outside or remote location installation.



Pressure transmitters

	For hygienic applications, with flush metallic diaphragm	For standard applications, with recessed stainless steel diaphragm and optional display module	For advanced applications, with corrosion and abrasion resistant ceramic diaphragm
	OPTIBAR P 2010	OPTIBAR PM 3050	OPTIBAR PC 5060
			
Accuracy (of calibrated span)			
Reference accuracy	<+/- 0.25% FSO	<+/- 0.2%; <+/- 0.1%	<+/- 0.2%; <+/- 0.1%; <+/- 0.05%
Long-term stability	-	+/-0.1% within 1 Year	+/-0.1% within 5 Years
Max. turn down	n/a	10:1	20:1 (100:1)
Pressure range			
Sensor	Piezoresistive	Piezoresistive	Ceramic
Measuring range (Level, water column)	1.0...400m	4...1000m	0.25...1000m
Nominal range (Pressure)	0.1...40bar/1.45 ... 580psi	0.4...100bar/5.8...1450psi	0.025...100bar/0.36...1450psi
Pressure rating	n/a	n/a	n/a
Overload resistance	5x1bar, 4x10bar, 2.5x40bar/ 5x1.45 psi, 4x14.5psi, 2.5x580 psi	5x1bar, 4x10bar, 2.5x40bar/ 5x1.45 psi, 4x14.5psi, 2.5x580 psi	35x1bar, 9x10bar, 5x40bar/ 35x1.45 psi, 9x14.5psi, 5x580 psi
Process connection			
Thread	≥ G1/2" front flush	≥ G1/2" front flush	≥ G1/2" front flush
Flange	n/a	with OPTIBAR DS series	from DN25, 1" ASME
Hygienic	Clamp ≥ 3/4" ISO2852, DIN32676 ≥ DN25 acc. DIN11851 SMS 1145 DN38 Varivent N	with OPTIBAR DS series	Clamp ≥1" ISO2852, DIN32676 ≥ DN25 acc. DIN11851 DIN 11864-1, -2, -3 Varivent, SMS, DIN 11851, NEUMO Biocontrol, Neumo BioConnect
Other	n/a	n/a	PMC, Swagelok VCR, etc.
Temperature range			
Process	-40...+125°C/-40...257 °F -40...+300°C/-40...572 °F with cooling fins	-40...+125°C/-40...257 °F	-40...+ 150 °C/-40...302 °F
Ambient	-40...+85°C/-40...+185 °F	-40...+85°C/-40...+185 °F	-40 ...+80°C/-40...+176 °F
Configuration			
PC tool	n/a	n/a	Free DTM, USB-Interface
Software / HHT	n/a	n/a	Yes - generic and DD
Local	none - fixed measurement range	with optional display and adjustment module	with optional display and adjustment module
Material			
Housing	316L	316L	DIN Housing in 1- or 2-chamber 316L, Aluminum, 316L (electropolished), Plastic (PBT)
Diaphragm material	316L	316L	99.996% Al2O3 Ceramic
Communication			
Output	4...20mA, 0-10V, PNP/NPN switching output*, IO-link*	4...20 mA HART® 7	4...20 mA HART® 7, FOUNDATION™ fieldbus, PROFIBUS® PA
Approvals			
Ex	ATEX / IECEx Ex ia 1G / 1D	ATEX / IECEx Ex ia*	ATEX / IECEx Ex ia, Ex d ; Ex t
Functional safety	n/a	n/a	SIL 2/3
Hygienic	3-A sanitary standard	with OPTIBAR DS series: 3-A, EHEDG	3-A, EHEDG
Other	cULus*	-	DNV-GL

	With fully welded metallic diaphragm for high pressure ranges and hygienic requirements	Differential pressure transmitter for hydrostatic level measurement with integrated absolute pressure measurement	Submersible level probe with ceramic diaphragm 22 mm/1" diameter
	OPTIBAR PM 5060	OPTIBAR DP 7060	OPTIBAR LC 1010
			
Accuracy (of calibrated span)			
Reference accuracy	<+/- 0.2%; <+/- 0.1%; <+/- 0.075%	<+/- 0.065%	<+/- 0.35% FSO
Long-term stability	+/-0.1% within 5 Years	+/-0.1% within 5 Years	<+/- 0.1% FSO within 1 year
Max. turn down	20:1 (100:1)	100:1	n/a
Pressure range			
Sensor	Piezoresistive, Thinfilm	Piezoresistive	Capacitive Ceramic
Measuring range (Level, water column)	4...10000m	0.1...160m	1...100m
Nominal range (Pressure)	0.4...1000bar/5.8...14500psi	10, 30, 100, 500mbar; 3, 16bar/0.15, 0.4, 1.4, 7.2, 44, 232 psi	1.0...10bar/1.45...145psi
Pressure rating	n/a	40bar, 160bar, 400bar/580, 2320, 5800 psi	n/a
Overload resistance	3x1bar, 3x10bar, 3x40bar/3x1.45psi, 3x14.5psi, 3x580psi	n/a	7x1bar, 2x10bar/7x1.45psi, 2x14.5psi
Process connection			
Thread	≥ G1/2" front flush	1/4"NPT , 1/2"NPT	n/a
Flange	from DN25, 1" ASME	with OPTIBAR DS series	n/a
Hygienic	Clamp ≥1" ISO2852, DIN32676 ≥ DN25 acc. DIN11851 DIN 11864-1, -2, -3 Vavent, SMS, DIN 11851, NEUMO Biocontrol, Neumo BioConnect	with OPTIBAR DS series	-
Other	with OPTIBAR DS series	with OPTIBAR DS series	n/a
Temperature range			
Process	-40...+ 105 °C/-40 ... 221 °F	-40 ... +85°C/-40 ... +185 °F	-25 ... +85°C/-13 ... +185 °F
Ambient	-40 ... +80°C/-40 ... +176 °F	-40 ... +80°C/-40 ... +176 °F	-25 ... +85°C/-13 ... +185 °F
Configuration			
PC tool	Free DTM, also USB-Interface	Free DTM, also USB-Interface	n/a
Software / HHT	Yes - generic and DD	Yes - generic and DD	Yes - generic
Local	with optional display and adjustment module	with optional display and adjustment module	none
Material			
Housing	DIN Housing in 1- or 2-chamber configuration: 316L, Aluminum, 316L (electropolished), Plastic (PBT)	DIN Housing in 1- or 2-chamber configuration: 316L, Aluminum, 316L (electropolished), Plastic (PBT)	316L, Titanium Gr.2*
Diaphragm material	316L , Egiloy	316L , Hastelloy C-276,	99.996% Al2O3 Ceramic
Communication			
Output	4...20 mA HART® 7, FOUNDATION™ fieldbus, PROFIBUS® PA	4...20 mA HART® 7, FOUNDATION™ fieldbus, PROFIBUS® PA	4...20mA with optional HART® 7, 3-wire Pt100
Approvals			
Ex	ATEX / IECEx Ex ia, Ex d ; Ex t	ATEX / IECEx Ex ia, Ex d ; Ex t*	ATEX / IECEx Ex ia 1G*
Functional safety	SIL 2/3	SIL 2/3	n/a
Hygienic	3-A, EHEDG	with OPTIBAR DS series: 3-A, EHEDG	n/a
Other	DNV-GL	DNV-GL*	DVGW drinking water

Diaphragm seals

	For general applications – Flange type; For mounting on a differential pressure transmitter; Direct	For general applications – Flange type; For mounting on a differential pressure transmitter; Capillary	For general applications – Flange type; For mounting on a differential pressure transmitter; Direct/ Capillary
	OPTIBAR DSD 3100	OPTIBAR DSD 3110	OPTIBAR DSD 3210
			
Process Connection			
Flange acc. EN 1092-1	DN50...100 PN10...100	DN50...100 PN10...100	DN50...100 PN10...100
Flange acc. ASME B16.5	2" ...4" Class 150...1500	2" ...4" Class 150...1500	2" ...4" Class 150...1500
Flange acc. JIS B2220	DN50...100 10K	DN50...100 10K	DN50...100 10K
Thread	n/a	n/a	n/a
Construction			
Diaphragm	Front flush or extended	Front flush or extended	Front flush or extended
Flushing holes	n/a	n/a	n/a
Attachment specifications	Direct up to 150°C/302°F	Direct/ Capillary up to 150°C/302°F	Direct/ Capillary up to 150°C/302°F
Material			
Basic body	Stainless steel 316L	Stainless steel 316L	Stainless steel 316L
Diaphragm and Sealing face	- Stainless steel 316L - Tantalum - Hastelloy C-276 - Titanium Grade 2 - Monel 400 - Duplex - Gold coating - PTFE foil - PFA coating	- Stainless steel 316L - Tantalum - Hastelloy C-276 - Titanium Grade 2 - Monel 400 - Duplex - Gold coating - PTFE foil - PFA coating	- Stainless steel 316L - Tantalum - Hastelloy C-276 - Titanium Grade 2 - Monel 400 - Duplex - Gold coating - PTFE foil - PFA coating
Lower body	n/a	n/a	n/a
Sealing	n/a	n/a	n/a
Fill fluid	- Silicone oil - Silicon free synthetic oil - Vacuum- and high temperature oil - Halocarbon oil - Glycerin/Water	- Silicone oil - Silicon free synthetic oil - Vacuum- and high temperature oil - Halocarbon oil - Glycerin/Water	- Silicone oil - Silicon free synthetic oil - Vacuum- and high temperature oil - Halocarbon oil - Glycerin/Water
Spiral tube (Capillary)	n/a	Stainless steel 316L or PVC coated	Stainless steel 316L or PVC coated
Distance tube	Stainless steel 316L	n/a	Stainless steel 316L
Length			
Extension	50...200 mm for 316L, PFA, Hastelloy C-276 and Tantalum 50...500 mm for 316L	50...200 mm for 316L, PFA, Hastelloy C-276 and Tantalum 50...500 mm for 316L	50...200 mm for 316L, PFA, Hastelloy C-276 and Tantalum 50...500 mm for 316L
Capillary	n/a	1,6...10 m/5.25...32.8ft	1,6...10 m/5.25...32.8ft

	For general applications – Flange type; For mounting on a differential pressure transmitter; Capillary/ Capillary	For special applications – Threaded version or open flange connection; For mounting on a pressure transmitter	For general applications – Flange type; For mounting on a pressure transmitter
	OPTIBAR DSD 3220	OPTIBAR DSP 2000	OPTIBAR DSP 3000
			
Process Connection			
Flange acc. EN 1092-1	DN50...100 PN10...100	Open measuring flange DN25...50 PN10...40	DN50...100 PN10...100
Flange acc. ASME B16.5	2"...4" Class 150...1500	Open measuring flange 1"...2" Class 150...300	2"...4" Class 150...1500
Flange acc. JIS B2220	DN50...100 10K	n/a	DN50...100 10K
Thread	n/a	G ½B EN 837-1, ½ NPT-M/F ANSI	n/a
Construction			
Diaphragm	Front flush or extended	Recessed	Front flush or extended
Flushing holes	n/a	2x ¼ NPT incl. Blind plugs	n/a
Attachment specifications	Capillary/ Capillary up to 400°C/ 752°F	Direct up to 150°C/302°F Direct with cooling fins up to 250°C/482°F Capillary up to 400°C/ 752°F	Direct up to 150°C/302°F Direct with cooling fins up to 250°C/482°F Capillary up to 400°C/ 752°F
Material			
Basic body	Stainless steel 316L	Stainless steel 316L	Stainless steel 316L
Diaphragm and Sealing face	- Stainless steel 316L - Tantalum - Hastelloy C-276 - Titanium Grade 2 - Monel 400 - Duplex - Gold coating - PTFE foil - PFA coating	- Stainless steel 316L - Hastelloy C-276 - Tantalum - PTFE foil	- Stainless steel 316L - Tantalum - Hastelloy C-276 - Titanium Grade 2 - Monel 400 - Duplex - Gold coating - PTFE foil - PFA coating
Lower body	n/a	Stainless steel 316L or PVDF	n/a
Sealing	n/a	NBR, FKM or PFFE	n/a
Fill fluid	- Silicone oil - Silicon free synthetic oil - Vacuum- and high temperature oil - Halocarbon oil - Glycerin/Water	- Silicone oil - Silicon free synthetic oil - Vacuum- and high temperature oil - Halocarbon oil - Glycerin/Water	- Silicone oil - Silicon free synthetic oil - Vacuum- and high temperature oil - Halocarbon oil - Glycerin/Water
Spiral tube (Capillary)	Stainless steel 316L or PVC coated	Stainless steel 316L or PVC coated	Stainless steel 316L or PVC coated
Distance tube	n/a	Stainless steel 316L	Stainless steel 316L
Length			
Extension	50...200 mm for 316L, PFA, Hastelloy C-276 and Tantalum 50...500 mm for 316L	n/a	50...200 mm for 316L, PFA, Hastelloy C-276 and Tantalum 50...500 mm for 316L
Capillary	2x 1,6...10 m	1,6...10 m/5.25...32.8ft	1,6...10 m/5.25...32.8ft



OPTISWITCH 3X00 C
Vibrating level
switches for solids



OPTISWITCH 5X00 C
Vibrating level switches
for liquids in process and
high temperature / high
pressure applications



OPTISWITCH 4000 C
Vibrating level switch for
basic liquid applications



OPTISWITCH 6500
Capacitance level switch
for advanced hygienic
applications



OPTISWITCH 6600
Capacitance level switch
for standard hygienic
applications

Level switches

Vibration

The measuring principle

The oscillating element of the OPTISWITCH consists of two paddle-shaped oscillating rods (1), coupled by a membrane (2). Together with the piezo ceramics (3), the rods and the membrane form an electromechanical resonator, which oscillates in the air at its own resonant frequency. The piezos are mechanically mounted and therefore unaffected by sudden temperature variations. When the oscillating rods are covered with fill goods, the oscillating frequency and amplitude change. This results in a frequency reduction of the spring-mass-system.

The frequency change depends on the density of the fill goods and the immersion depth of the oscillating rods. The oscillating frequency of the resonator is detected by a built-in transducer and converted into a switching command when a preset threshold value is exceeded. When the frequency changes only slightly, which is often the case on solids, the switch detects the change in amplitude instead. For solids, the fork is also considerably larger, making the device more sensitive to changes.

Some typical applications are over-fill and dry-run protection. Thanks to its very simple and rugged design, the OPTISWITCH can be used independently of the essential physical and chemical product characteristics in nearly all applications.

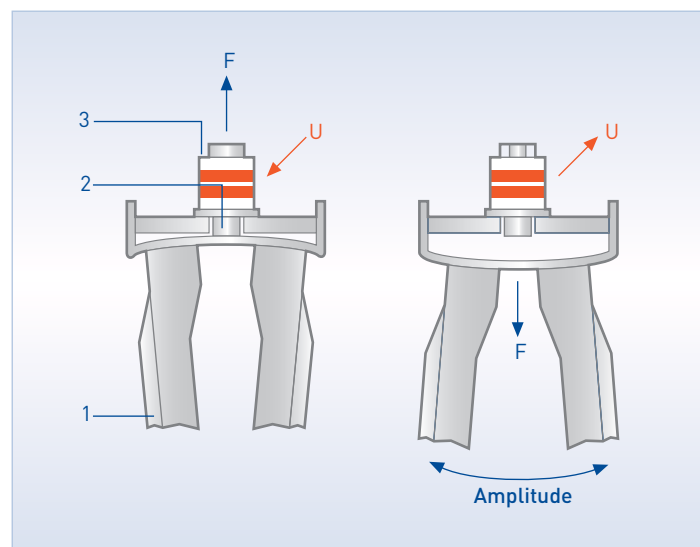

The Piezo effect

Piezo ceramics can be operated in two directions of effect. When an electrical voltage (U) is applied to piezo ceramics, they become physically deformed (F – actuator effect). Conversely, piezo ceramics convert mechanical deformation into an electrical voltage (sensor direction of effect). Both directions of effect are used for vibrating level switches.

Highlights:

- Rugged oscillating fork, high abrasion resistance
- Exactly reproducible switching point without adjustment
- Continuous self-monitoring of correct oscillating frequency, corrosion and cable breakage to the Piezo drive
- Measurement independent of media properties such as viscosity, dielectric constant (ϵ_r) or electrical conductivity
- Not sensitive to adhesions (foam), pressure and temperature changes or external vibrations
- Detection of solids with density $\geq 0.008 \text{ kg/l} / 0.5 \text{ lb/ft}^3$
- Detection of liquids with density $\geq 0.5 \text{ kg/l} / 31.2 \text{ lb/ft}^3$
- Wide temperature and pressure range: $-196 \dots +450^\circ\text{C} / -321 \dots +842^\circ\text{F}$, max. 160 barg/2320.6 psig
- Hygienic design with polished surface
- Recurring test as per WHG via test button (with SU 501)
- Detection of solids in water
- Functional safety: up to SIL2 in a single channel architecture, and up to SIL3 in a multiple channel, redundant architecture



OPTISWITCH – The rugged solution for solids and liquids

In the construction materials industry, heavy dust build-up and mechanical stresses are a challenge for any level switch. This is not a problem for OPTISWITCH: The rugged unit detects the limit in the silo independently of the medium properties and reliably warns against overfilling. OPTISWITCH even masters tall, narrow silos due to the product-independent switching point. This is especially beneficial for rapid or recurring changes of media. Even AEROSIL® and other very light solids can be reliably and safely detected using OPTISWITCH.

Thanks to the exact reproducibility of the switching point and the integrated function monitoring, the OPTISWITCH is often used as overfill protection (§19 WHG) or dry-run protection for pumps. Neither adhesions on the oscillating fork nor container vibrations have an impact on the measurement.

In high temperature and high pressure applications such as steam boilers, the new OPTISWITCH 5300 applies.

Industries:

- Oil & Gas
- Chemical
- Food & Beverage
- Pharmaceutical
- Water & Wastewater
- Building material
- Plastic processing

Capacitance

Highlights:

- Measurement independent of media properties
- Not sensitive to adhesives and foam
- No blockage of the pipeline, no pressure loss
- Independent of the position and vibration
- Hygienic installation by means of a hygienic process weld sleeve, nearly flush with the front
- Dry-run protection beyond a nominal width of DN15

The measuring principle

The capacitance switch operates by emitting an electromagnetic wave which penetrates the medium. Depending on the respective relative permittivity, a phase shift occurs which is then evaluated. This measuring process allows for universal use even when the medium changes.

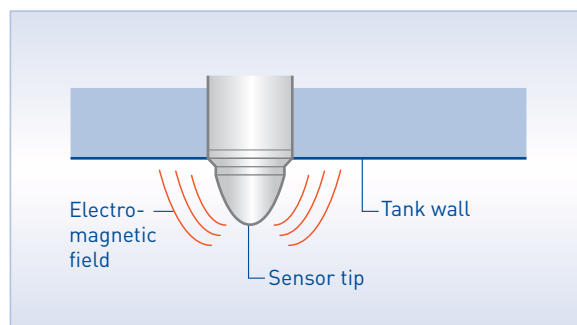

OPTISWITCH 6500/6600 C – The hygienic switches

Industries:

- Food & Beverage
- Pharmaceutical



OPTISWITCH 6500 C



OPTISWITCH 6600 C

The capacitance level switches of the OPTISWITCH 6500/6600 series handle various media in industries such as food, beverage and pharmaceutical: whether you are dealing with dairy products, toothpaste or cooking oil, the hygienic switches safely and reliably detect the level or serve as dry-run protection for pumps. They can also detect liquid/liquid interfaces or even identify the presence of a specific medium. The measurement remains unaffected by foam, condensate or build-up of deposits. Another advantage of this switch family is the very fast response time of the devices and their high immunity to vibrations.

Switches

	Vibrating level switch for solids	Vibrating level switch for basic liquid applications	Vibrating level switches for more demanding liquid applications	Capacitance level switches for hygienic applications
	OPTISWITCH 3X00 C	OPTISWITCH 4000 C	OPTISWITCH 5X00 C	OPTISWITCH 6500/6600 C
				
Measuring principle	Vibration	Vibration	Vibration	Capacitance
Measurable products	Solids and solids in water	Liquids	Liquids	Liquids and solids
Level/interface	+/+ (solids in water)	+/-	+/-	+/+
Standard length	220 mm/8.7"	66 mm/2.6"	66 mm/2.6"	18 mm/0.7"
Measuring range	-	-	-	-
Length with tube extension	0.3...6 m/11.8"...20 ft	-	0.08...6 m/0.26...20 ft	100/250 mm/3.9/9.8"
Length with cable extension	0.3...80 m/11.8"...262.4 ft	-	-	-
Product characteristics	Density: $\geq 0.008 \text{ kg/l}/\geq 0.5 \text{ lb/ft}^3$	Density: $\geq 0.7 \text{ kg/l}/\geq 43.7 \text{ lb/ft}^3$	Density: $\geq 0.5 \text{ kg/l}/\geq 31.2 \text{ lb/ft}^3$	Dielectric constant (ϵ_r) ≥ 1.5
Accuracy	-	-	-	-
Outputs	Relay, transistor, contactless switch, 2-wire output	Transistor, contactless switch	Relay, transistor, contactless switch, 2-wire output, NAMUR	Transistor, NPN/PNP
Power supply	Relay and contactless switch: 20...253 V AC/DC transistor output: 10...55 V DC	Contactless switch: 20...253 V AC/DC transistor output: 10...55 V DC	Relay and contactless switch: 20...253 V AC/DC transistor output: 10...55 V DC	12...36 V DC, max. 70 mA
Housing material	Plastic, aluminum, stainless steel	Plastic, stainless steel	Plastic, aluminum, stainless steel	Stainless steel
Ambient temperature	-40...+70°C/-40...+158°F	-40...+70°C/-40...+158°F	-40...+70°C/-40...+158°F	-40...+85°C/-40...+185°F
Protection category	IP66, 67; NEMA4, 4X, 6	IP65, 67; NEMA4, 4X, 6	IP66, 67; NEMA4, 4X, 6	IP67; NEMA4, 4X
Flange system				
Process connection				
Thread	G 1½; 1½ NPT	G ½, ¾, 1; ½, ¾, 1 NPT	G ¾, 1; ¾, 1 NPT	G ½
EN 1092-1	On request	-	$\geq \text{DN}25$ in PN16...64	-
ASME B 16.5	On request	-	$\geq 1"$ in 150...300 lb	-
Pressure range				
Process	-1...16 barg/-14.5...232 psig	-1...64 barg/-14.5...928.2 psig	-1...160 barg/-14.5...2320.6 psig	-1...16 barg/-14.5...232 psig
Temperature range				
Process	-50...+250°C/-58...+482°F	-40...+150°C/-40...+302°F	-196...+450°C/-321...+842°F	-20...+85°C/-4...+185°F
Materials				
Wetted parts	Stainless steel 1.4435/1.4404 (316L), 1.4462 (318S13)	Stainless steel 1.4435/1.4404 (316L), others on request	Stainless steel 1.4571 (316Ti), Hastelloy® C, enamel, ECTFE, PFA, Inconel 718	Stainless steel 1.4404 (316L)
Gasket	Klingsit® C-4400 (for thread)	Klingsit® C-4400 (process seal)	Klingsit® C-4400 (for thread)	-
Approvals				
Ex	ATEX, FM, CSA, EAC	-	ATEX, FM, CSA, EAC	ATEX, EAC
Miscellaneous	SIL	§19 WHG, EAC	§19 WHG, shipping approvals, SIL	3A / FDA

Communication technology

Drivers · Protocols · Configuration · Diagnostics

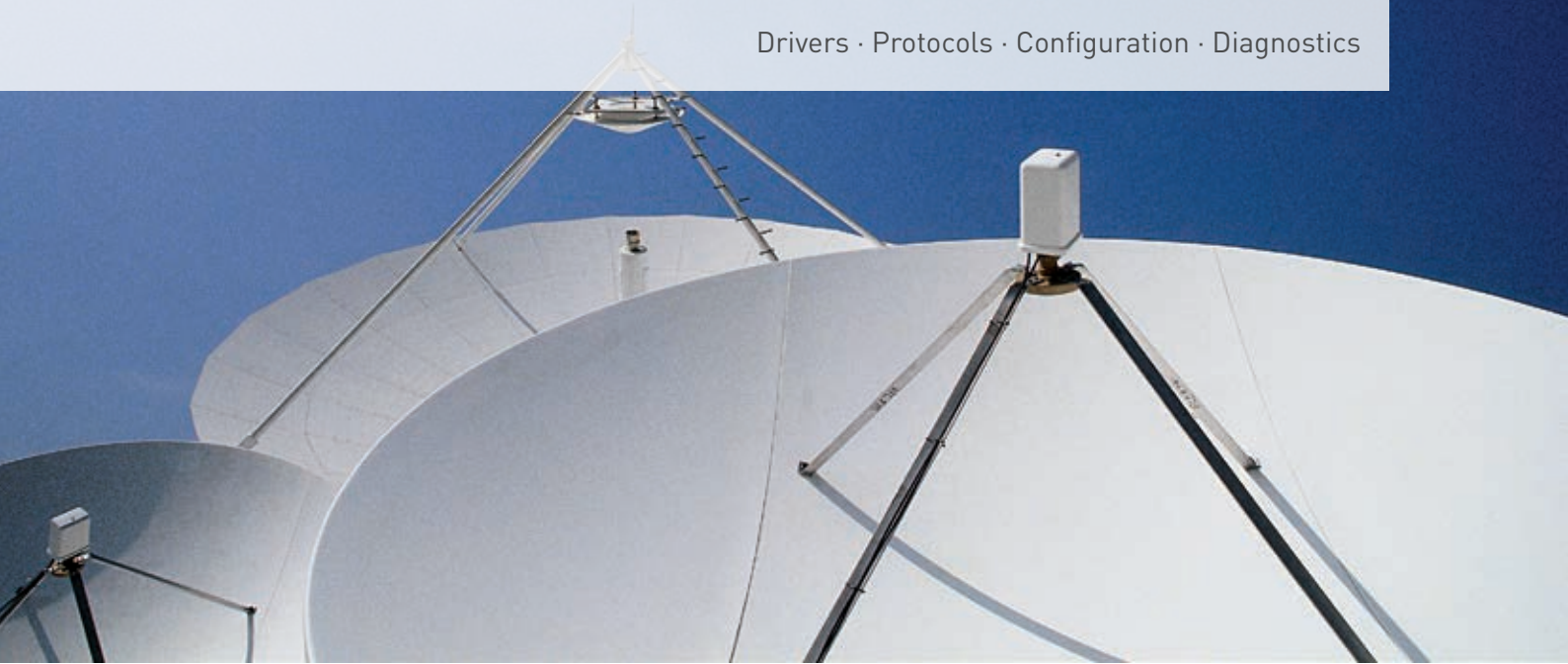

Open for the future

KROHNE is committed to making communication convenient. Which is why our field devices communicate reliably with controllers, control systems and PCs, and can also be used for a variety of control and regulating tasks.

Protocols and interfaces

We support proven and established protocols as well as new ones for certain industries, e.g. EtherNet/IP™ for the food and beverage industries, or PROFINET® for the water and wastewater sector.

Device integration

KROHNE meets all of the prerequisites for integration into modern plant asset management systems, based on integration technologies such as DD/EDD and FDT/DTM.

We are a longstanding member of PACTware™ and the FDT Group®. Since 2003, we provide DTMs and EDDs for our field devices with HART®, PROFIBUS® or FOUNDATION™ fieldbus interfaces.



Configuration and diagnostics via DTMs



Easy navigation, device status available anytime

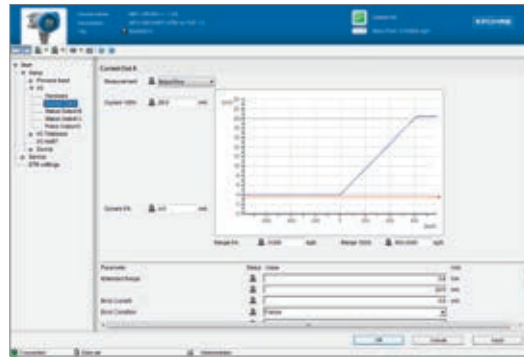

Simple parameterisation supported by graphic elements



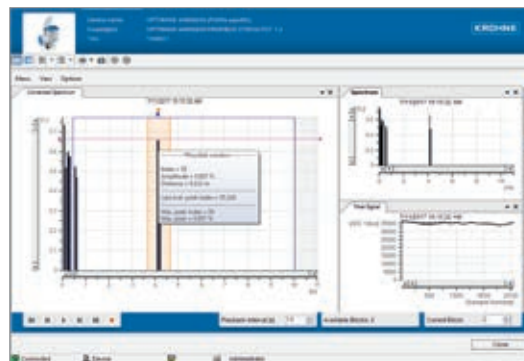

Detailed diagnostics overview with recommendations to resolve actual events

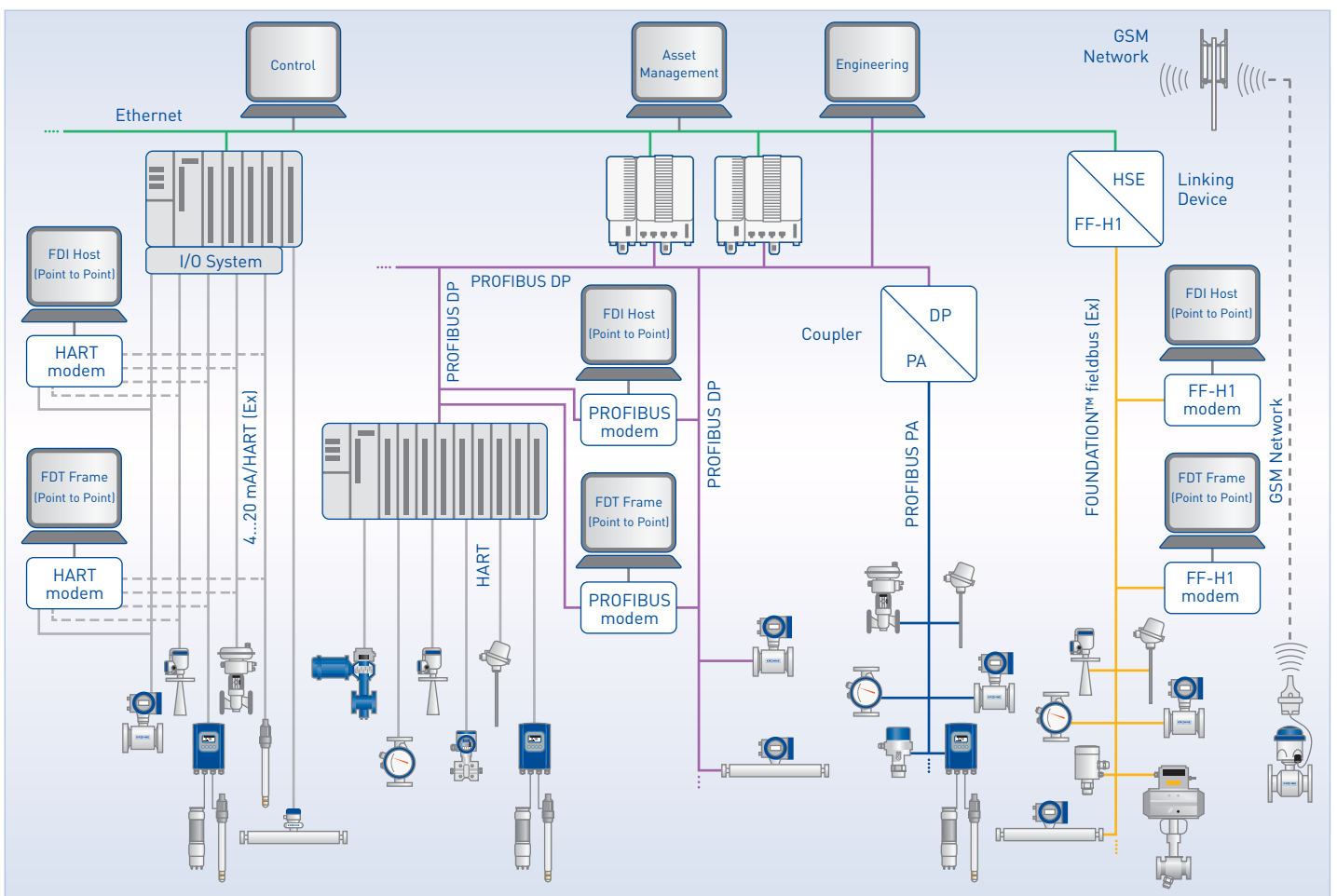

Advanced monitoring functions with optional recording of events

Fast and convenient access to process and device data from any level





Services

Project services · Online tools · Maintenance services · Metrological services · Seminars · In-situ verification · Calibration

Beyond the highest requirements

From engineering and planning to commissioning, training and documentation: our services cover all project stages, and can be offered for all enterprise sizes:

- Complete project management for instrumentation projects
- Engineering
- Commissioning
- On-site start-up
- Product training (on-site)
- Calibration, (in-situ) verification and documentation
- Maintenance services
- Seminars and trainings on various topics

Please see right page for more details on selected services.



Commissioning of flowmeters

Online tools:



PiCK

Enter the serial number and get device specific documents, e.g. manuals, handbooks, calibration certificates, etc.:
pick.krohnegroup.com

Configure It

Configure It

Configure flow and level devices and get free 2D/3D CAD data:
www.krohne-direct.com

Maintenance services

Choose from maintenance and service contracts tailored to suit all business sizes and needs:

- Spare parts and consumables
- Field service and on-site repair
- Returns
- Workshop repair
- Helpdesk

Metrological accreditation of custody transfer applications

We offer special services for metrological accreditation of measuring and loading systems for liquids and gases, according to local fiscal regulations:

- Project management from planning to commissioning, training and documentation
- For mobile and stationary measuring systems

Seminars: KROHNE Academy & KROHNE Academy online

KROHNE Academy is a series of seminars in collaboration with leading automation companies. Taking place in various countries, it addresses key operating issues, from plant safety to ways of increasing efficiency and controlling costs, and shows possible solutions. Should your interest be more towards working "hands-on" with our devices, then our service academy is what you are looking for. Learn more about KROHNE Academy at www.krohne.com

KROHNE Academy online is an online eLearning platform, focusing on industrial process instrumentation. It comprises electronic learning content with full audio, explaining measuring technology without relation to specific manufacturers. Register now for free and start your training at academy-online.krohne.com



Large team of field service engineers and technicians



MID MI-005 tanker filling system for liquefied gas



Functional safety seminar at KROHNE headquarters, Duisburg, Germany

In-situ verification

OPTICHECK is the essential tool to assure that your process measuring devices are performing according to specification. When connected to an installed meter (in-situ), it gathers data to ensure that the meter is performing within 1% of the factory calibration.

- Printed individual verification certificate
- Preventive maintenance and service features
- Storage of verification data
- Download factory calibration settings from KROHNE manufacturing database



Calibration from KROHNE: Certainty you can count on

Calibration of high pressure/high flow gas and liquid meters

For oil&gas flow metering systems, our partner EuroLoop in Rotterdam, The Netherlands, offers testing and calibration according to European MID, EN or IEC standards or OIML recommendations.

With their large closed loop facilities, single meters or complete skids can be calibrated with:

- Natural gas: 20...30,000 m³/h for sizes 6...36" up to ANSI 900 with best overall uncertainty (CMC) of 0.17%
- Liquid hydrocarbons: sizes 4...30" up to 5,000 m³/h, large range of Reynolds numbers, viscosities 1...400 mm²/s (cSt), with best overall uncertainties 0.02% for volume and 0.04% for mass

The world's most precise volumetric calibration rig for flowmeters up to DN3000/120"

Calibration is one of KROHNE's core areas of expertise. If you buy a KROHNE product, you will get a measuring device that performs most accurate with low uncertainty under real process conditions.

To achieve this, we operate more than 140 calibration facilities for volume flow, mass flow, level, temperature, density and pressure to (wet-)calibrate any device we manufacture. For example, every flowmeter is wet-calibrated using water or air as standard before leaving our facilities.

We can also provide customer specific calibration such as:

- Carry out multipoint calibrations
- Vary different parameters such as temperatures, viscosities, pressures etc.
- Use the actual medium or similar
- Build or emulate customer-specific flow geometries
- Use piping provided by the customer

For calibration we only use direct comparison of measurands (e.g. we calibrate our Coriolis mass flowmeters with a gravimetric weighing system). Our calibration rigs are the most accurate used in measuring device production worldwide: the accuracy of the reference is usually 5 to 10 times better than that of the meter under test.

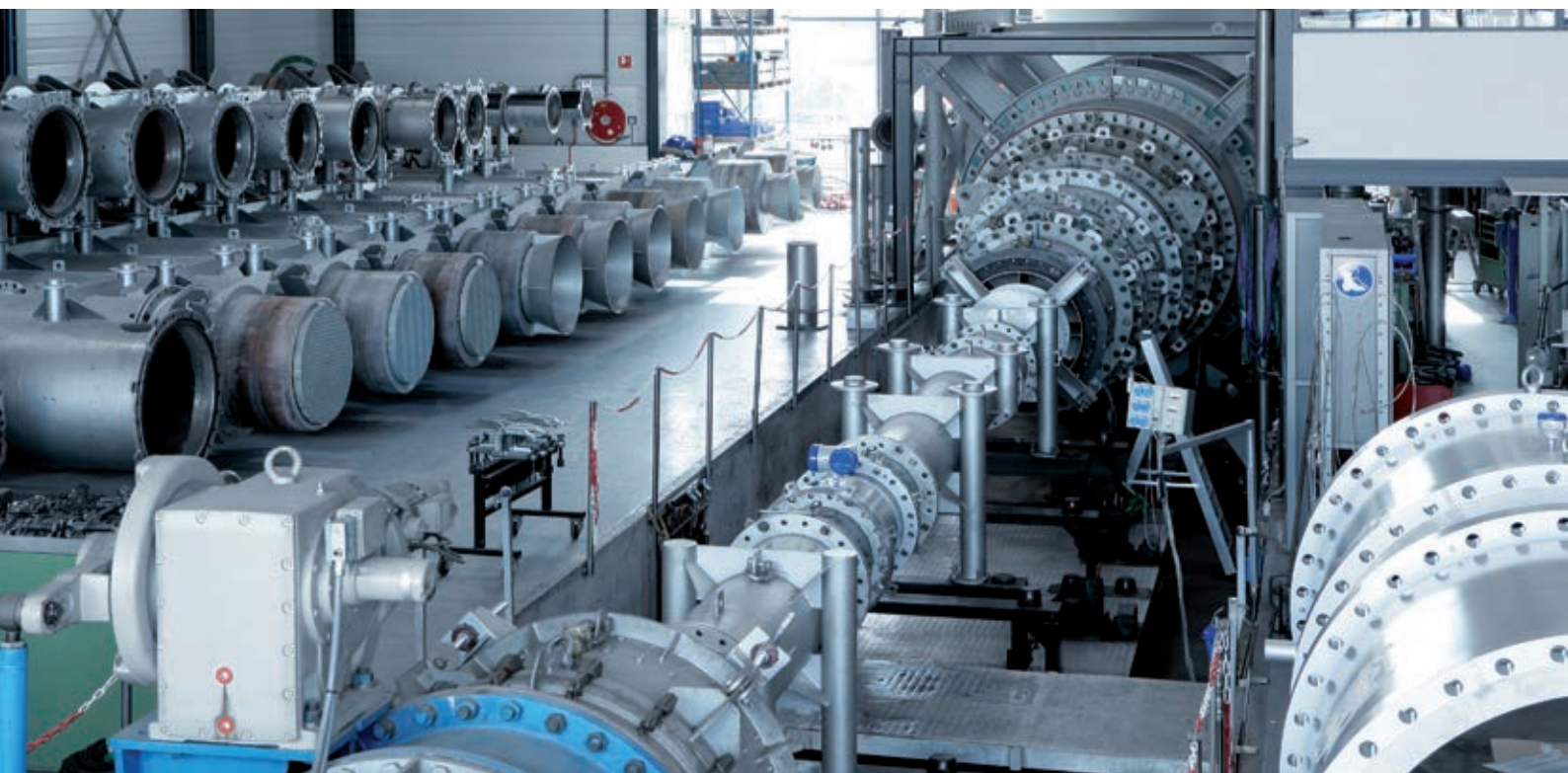

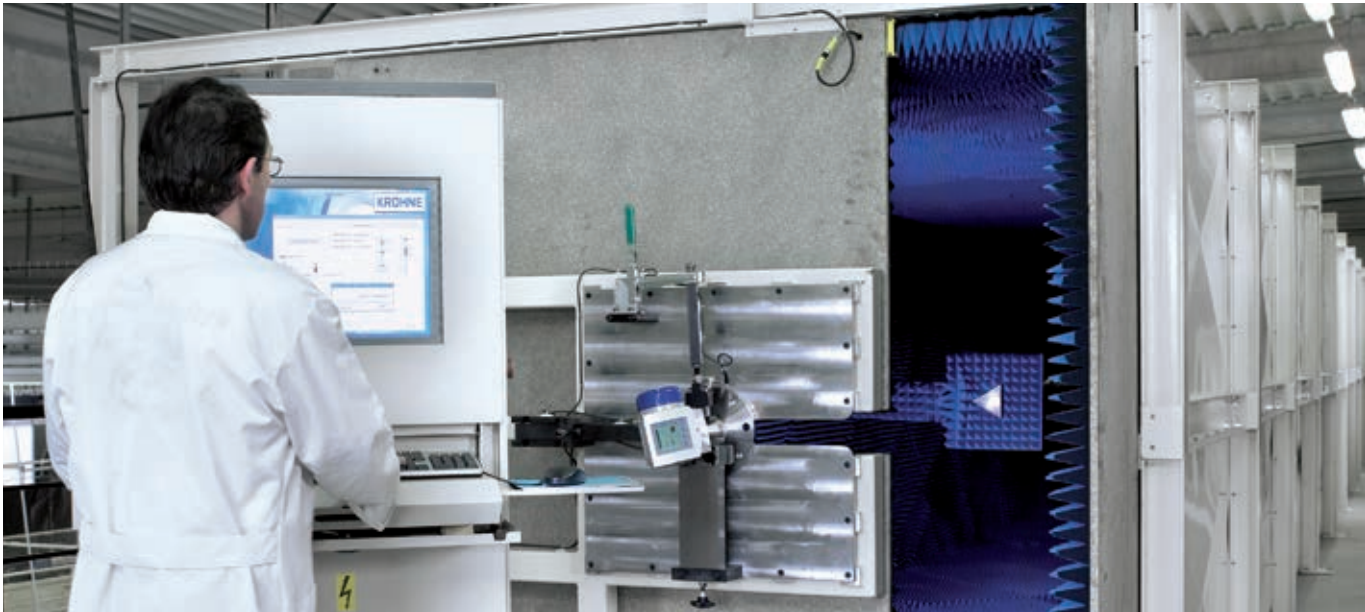

Stretch for calibration of FMCW level transmitters

Volumetric piston prover

This goes for small as well as for very large sizes: KROHNE operates the world's most precise volumetric calibration rig for flowmeters up to DN3000/120" with a certified accuracy of 0.013 %. The reference vessel is a 44 m/144 ft high tank containing almost 0.5 million litres/132,000 gal (US) of water which allows for a maximum flow rate of 30,000 m³/h/7,925,000 gal (US)/h.

Certified technology for fiscal & custody transfer applications

Our meters can be calibrated and certified according to various standards such as OIML, API, Measuring Instruments Directive (MI-001, 002, 004, 005), GOST, etc. The standards we use for calibration are ISO/IEC 17025 accredited and traceable to international or national standards. Regular inspections by national metrology institutes, round robin tests and alignments with national and international metrological standards according to ISO 9000 and EN 45000 guarantee the quality and comparability of our calibration rigs. Staff performing the calibrations are trained and given regular re-trainings to ensure quality and continuity.



KROHNE – Products, Solutions and Services

- Complete product portfolio: flow, level, temperature, pressure, process analytics
- Application-specific system solutions for various industries
- Services for instrumentation projects



Contact

Head office:
KROHNE Messtechnik GmbH
Ludwig-Krohne-Str. 5
47058 Duisburg
Germany
Tel.: +49 203 301 0
Fax: +49 203 301 103 89
info@krohne.com

Global companies and representatives
The current list of all KROHNE contacts
and addresses can be found at:
www.krohne.com