



 **FREE**  
UPS Ground shipping  
on orders of \$50+\*  
\*For more details visit [zoro.com/shipping](http://zoro.com/shipping)



[ZORO.COM](http://ZORO.COM)

# 2015 PRODUCT GUIDE

MORE THAN **6,300** OF OUR MOST POPULAR PRODUCTS

 MORE THAN **800,000** UNIQUE ITEMS ONLINE



# OUR **PROMISE** TO YOU ≡



## HUGE SELECTION OF PRODUCTS

We offer 800,000+ products that help keep your business and home safe, clean and working in perfect order.



## GREAT PRICES ON EVERYTHING

Every customer pays the same low price for an item—whether you buy one or one thousand.



## EASY ORDERING & QUICK DELIVERY

Most orders are processed and ship the same day—expedited shipping is available.



## TERRIFIC CUSTOMER SERVICE

Our dedicated team works their tails off to make sure you have the best experience possible.

## **FREE**

UPS Ground shipping on orders of \$50+\*

\*For more details visit [zoro.com/shipping](http://zoro.com/shipping)



### STAY IN THE KNOW...

visit [zoro.com/email](http://zoro.com/email) and sign up for z-mails to receive emails, **plus** get \$5 off your order of \$25 or more!

## ZORO.COM IS OPEN 24 HOURS, 7 DAYS A WEEK, SO ORDER ANYTIME ... MOST ORDERS SHIP THE SAME DAY!

Give us a call! Our customer service hours are  
monday thru friday 7am to 7pm (CT),  
saturday 7am to 3:30pm · se habla español

 click [www.zoro.com](http://www.zoro.com)  call 855.289.9676  fax 855.329.9676











WE ACCEPT     &  (PayPal is available for online orders only)

## **WE'RE SOCIAL... FOLLOW US!**

Check out our social pages for exclusive promotions, special news & events, Zoro the Fox's antics and much more...



\$ prices subject to change

<p><b>SAFETY</b></p> <p>pg 4</p> 	<p><b>PLUMBING</b></p> <p>pg 42</p> 	<p><b>ELECTRICAL</b></p> <p>pg 70</p> 	<p><b>FANS &amp; HVAC</b></p> <p>pg 112</p> 	<p><b>TOOLS</b></p> <p>pg 132</p> 
	<p><b>JANITORIAL &amp; GROUNDS</b></p> <p>pg 162</p> 	<p><b>MATERIAL HANDLING</b></p> <p>pg 188</p> 	<p><b>MACHINE TOOLS &amp; ACCESSORIES</b></p> <p>pg 210</p> 	<p><b>AUTO &amp; TRUCK</b></p> <p>pg 234</p> 
		<p><b>ABRASIVES</b></p> <p>pg 248</p> 	<p><b>FASTENERS</b></p> <p>pg 256</p> 	<p><b>TAPES &amp; ADHESIVES</b></p> <p>pg 272</p> 

# TABLE OF CONTENTS

## SAFETY 4

- 5 • gloves, eyewear, ear protection, masks & clothing
- 18 • fall protection, facility & traffic safety equipment
- 30 • padlocks, lockout/tagout & security equipment
- 36 • signs & labels

## PLUMBING 42

- 43 • pipes, valves & fitting
- 58 • toilets, sinks, faucets & plumbing supplies

## ELECTRICAL 70

- 71 • electrical supplies & generators
- 90 • lighting, flashlights & batteries

## TEST INSTRUMENTS & GAUGES 104

## FANS & HVAC 112

## TOOLS 132

- 133 • hand tools
- 147 • power tools and accessories
- 156 • cutting, holmaking & shaping tools

## JANITORIAL & GROUNDS MAINTENANCE 162

- 163 • janitorial & cleaning supplies
- 175 • grounds maintenance & outdoor equipment
- 182 • paint, coatings & supplies

## MATERIAL HANDLING 188

- 189 • storage, shelving, ladders & lifts
- 198 • carts, trucks & casters
- 204 • drum & dock equipment
- 206 • pulling, lifting, lowering & conveying

## MACHINE TOOLS & ACCESSORIES 210

- 211 • bearings, v-belts & power transmission equip.
- 216 • knobs, handles, workholding & machine tool acc.

## PNEUMATICS 220

## HYDRAULICS 230

## AUTO & TRUCK 234

## FLUIDS & LUBRICANTS 244

## ABRASIVES 248

## WELDING & SOLDERING 253

## FASTENERS 256

## HINGES & HARDWARE 264

## RAW MATERIALS 268

## TAPES & ADHESIVES 272

- 273 • adhesives & sealants
- 276 • tapes (electrical, duct & painters)

## SHIPPING & OFFICE SUPPLIES 278

- 278 • shipping & packing supplies
- 282 • office supplies, furniture & breakroom supplies



# SAFETY



## TOP BRANDS



### GLOVES

pg 7



### HEARING PROTECTION

pg 10



### HARD HATS

pg 10



### PROTECTIVE CLOTHING

pg 15



### FALL PROTECTION GEAR

pg 18



### SAFETY CONES AND POSTS

pg 26



### FIRE SAFETY

pg 28



### SAFES

pg 30



### PADLOCKS

pg 32



### SIGNS

pg 36



**CONDOR**  
**String Knit Gloves**

- Polyester/cotton
- 7.0 gauge
- Reversible
- For assembly, parts handling, general maintenance and material handling applications

Z#	size
G0048982	x-small
G0048973	small
G0048964	large
G0048955	x-large

pair **\$0.69**

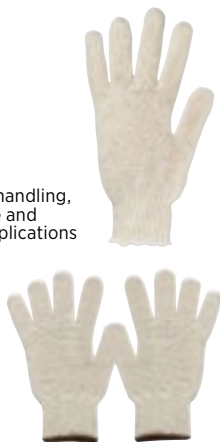
**CONDOR**  
**Canvas Gloves**

- Cotton
- 8oz
- Knit cuff
- Clute cut
- Straight thumb

Z#	size	length
G0048291	small	9 3/4"
G0048307	large	10 1/2"

pair **\$1.76**

**CONDOR**  
**Pigskin Driver's Gloves**

- Pigskin leather
- Shirred cuff
- Gunn cut
- Keystone thumb with shield
- Unlined

Z#	size
G0055124	x-small
G0055072	small
G0055106	medium
G0055115	large
G0055081	x-large
G0055097	2x-large

pair **\$15.76**

**CONDOR**  
**Coated String Knit Gloves**

- Polyester/cotton
- Ambidextrous
- Double-sided dotted PVC grips
- For general maintenance, material handling, assembly, shipping and receiving

Z#	size
G0057477	x-small
G0057495	small
G0057486	large
G0057452	x-large
G0057461	2x-large

pair **\$1.13**

**CONDOR**  
**Leather Palm Gloves**

- Split cowhide palm
- Striped cotton backing
- Unlined
- Wing style thumb
- Gunn cut

**Knit Wrist**

Z#	size
G0054004	small
G0053995	large
G0053986	x-large

pair **\$3.14**

**Gauntlet Cuff**

Z#	size
G0054126	small
G0054135	large
G0054117	x-large

pair **\$4.31**

**CONDOR**  
**Cowhide Driver's Gloves**

- Cowhide leather
- Shirred cuff
- Gunn cut
- Straight thumb
- Unlined

**Economy Cowhide**

Z#	size
G0055063	x-small
G0055054	small
G0055045	medium
G0055036	large
G0055027	x-large
G0055011	2x-large

pair **\$13.08**

**Grain Cowhide**

Z#	size
G0055194	small
G0055212	medium
G0055176	large
G0055203	x-large
G0055185	2x-large

pair **\$14.06**

**CONDOR**  
**Glove Liners**

- Universal size
- Poly/cotton
- Worn under gloves to absorb perspiration
- 100 pack

Z#	length	price
G1271532	7"	<b>\$59.19</b>
G0892254	12"	<b>\$65.77</b>

**HEXAMOR**  
**Heat Resistant Gloves**

- Cotton/canvas/SuperFabric
- Jute/burlap/SuperFabric lining
- 450°F max temp
- Extended canvas safety cuff
- ■ ISEA AND CE LEVELS STANDARDS

Z#	size
G0594955	large
G0468334	medium
G1623395	x-large

pair **\$30.99**

**CONDOR**  
**Split Cowhide Driver's Gloves**

- Split cowhide palm
- Shirred cuff
- Gunn cut
- Straight thumb
- Unlined

Z#	size
G0054923	small
G0054932	medium
G0054941	large
G0054957	x-large
G0054914	2x-large

pair **\$7.09**

**eZ TIPS**  
technical resources**GLOVE SIZING CHART**

Wrap a tape measure around your palm to determine the circumference of your hand in inches. Refer to the sizing chart to determine your appropriate glove size.

palm size	glove size
6" to 7"	x-small
7" to 8"	small
8" to 9"	medium
9" to 10"	large
10" to 11"	x-large
11" to 12"	2x-large





# SAFETY

MORE THAN 800,000 ITEMS ONLINE



### MECHANIX WEAR FastFit Mechanic's Gloves

- Synthetic leather palm
- Padded spandex back and knuckle
- Shirred elastic cuffs
- Keystone thumb

#### Black

Z #	size
G4387722	small
G4387731	medium
G4387747	large
G4387756	x-large
G4387765	2x-large

pair **\$9.88**

#### Blue

Z #	size
G4387677	small
G4387686	medium
G4387695	large
G4387704	x-large
G4387713	2x-large

pair **\$9.88**



#### Red

Z #	size
G4387625	small
G4387634	medium
G4387643	large
G4387652	x-large
G4387661	2x-large

pair **\$9.88**



### MECHANIX WEAR The Original All Purpose Mechanic's Gloves

- Synthetic leather palm
- Spandex back
- Wing style thumb
- Foam padded lining
- Hook and loop closure

Z #	size
G0022662	small
G0022671	medium
G0022687	large
G0022696	x-large
G0022705	2x-large

pair **\$16.49**



### TILLMAN TrueFit Mechanic's Gloves

- Top grain goatskin leather palms
- Spandex back
- Wing style thumb
- Unlined
- Hook and loop closure

Z #	size
G0130541	small
G0130557	medium
G0130566	large
G0130575	x-large
G0130584	2x-large

pair **\$10.73**



### HEXARMOR SuperFabric Cut Resistant Gloves

- SuperFabric lining
- Synthetic leather palm
- Abrasion resistant
- Clute cut
- Puncture resistant
- ■ ANSI/ISEA CUT LEVEL 5, ABRASION LEVEL 4, PUNCTURE LEVEL 1

Z #	size
G4304851	medium
G4312664	large
G4304842	x-large

pair **\$39.49**



### CONDOR Mechanic's Gloves

- Synthetic leather palm
- Abrasion resistant palm
- Neoprene back
- Wing style thumb
- Unlined

Z #	size
G0022355	small
G0022346	medium
G0022337	large
G0022321	x-large
G0022312	2x-large

pair **\$16.07**



### RINGERS GLOVES Kevloc Cut Resistant Gloves

- Impact resistant
- Hi-Vis green
- For rigging, mining, oil fields, material handling
- ■ ANSI/ISEA CUT LEVEL 3

Z #	size
G4519216	small
G4519225	medium
G4519234	large
G4519243	x-large
G4519252	2x-large
G4519261	3x-large

pair **\$33.61**



### CONDOR Basic Cut Resistant Gloves

- Lightweight uncoated Kevlar lining
- Abrasion resistant
- Clute cut
- Wing style thumb
- ■ ANSI/ISEA CUT LEVEL 2, ABRASION LEVEL 1

Z #	size
G0065642	small
G0065633	large

pair **\$2.13**



### IRONCLAD Light Duty Mechanic's Gloves

- Synthetic leather palm
- Ribbed stretch nylon back
- Slip on
- Full finger style

Z #	size
G4517511	small
G4517527	medium
G4517536	large
G4517545	x-large

pair **\$15.49**



### NIROFLEX Mesh Cut Resistant Gloves

- Stainless steel mesh coating
- Puncture resistant
- Wrist length cuff
- Ambidextrous
- Full finger style
- ■ ANSI/ISEA CUT LEVEL 5

Z #	size
G4416237	2x-small
G4416212	x-small
G4503161	small
G4416221	medium
G4453127	large
G4416246	x-large

pair **\$88.78**



**ANSELL**  
**SensiLite Palm-Coated Gloves**

- Polyurethane coating with textured finish
- Nylon lining
- Elastic cuff
- Resists abrasions
- ■ ANSI/ISEA, ABRASION LEVEL 3

② #	size
G0050531	x-small
G0050547	small
G0050556	medium
G0050565	large
G0050574	x-large
G0050583	2x-large

 pair **\$1.48**

**ANSELL**  
**HyFlex 11-624 Palm-Coated Gloves**

- Polyurethane coating
- Performance polyethylene/dyneema lining
- Knit cuffs
- ■ ANSI/ISEA ABRASION LEVEL 5, CUT LEVEL 2, PUNCTURE LEVEL 4

② #	size
G0064276	x-small
G0064285	small
G0064294	medium
G0064303	large
G0064312	x-large
G0064321	2x-large

 pair **\$7.62**

**SHOWA BEST**  
**Atlas Fit Palm-Coated Gloves**

- Natural rubber latex coating with wrinkled finish
- Polyester/cotton lining
- Knit wrist cuffs
- 10 gauge
- ■ ANSI/ISEA ABRASION LEVEL 4, CUT LEVEL 2, PUNCTURE LEVEL 3

② #	size
G0051335	small
G0051326	medium
G0051317	large
G0051344	x-large
G5238152	2x-large

 pair **\$2.21**

**ANSELL**  
**HyFlex 11-627 Palm-Coated Gloves**

- Polyurethane coating
- High-performance polyethylene/dyneema lining
- Knit cuff
- Clute cut
- ■ ANSI/ISEA ABRASION LEVEL 6, CUT LEVEL 2, PUNCTURE LEVEL 5

② #	size
G0064233	7
G0064242	8
G0064251	9
G0064267	10
G0064215	11

 pair **\$7.98**

**ANSELL**  
**HyFlex 11-500 Palm-Coated Gloves**

- Nitrile coating
- Kevlar lining
- Knit cuff and clute cut
- Resists abrasions, cuts, tears, punctures
- ■ ANSI/ISEA ABRASION LEVEL 3, CUT LEVEL 2, PUNCTURE LEVEL 3

② #	size
G0063357	x-small
G0063366	small
G0063375	medium
G0063384	large
G0063393	x-large
G0063341	2x-large

 pair **\$5.19**

**ANSELL**  
**HyFlex 11-600 Palm-Coated Gloves**

- Polyurethane coating with smooth finish
- Nylon lining
- Knit wrist cuffs
- Resists abrasions
- ■ ANSI/ISEA, ABRASION LEVEL 2, CUT LEVEL 1

② #	size
G0050696	6
G0050705	7
G0050714	8
G0050723	9
G0050732	10
G0050687	11

 pair **\$2.36**

**ANSELL**  
**HyFlex 11-800 Palm-Coated Gloves**

- Nitrile coating with foamed finish
- Nylon lining
- Knit wrist cuffs
- Resists abrasions
- ■ ANSI/ISEA ABRASION LEVEL 3, CUT LEVEL 1

② #	size
G0053611	x-small
G0053627	small
G0053636	medium
G0053645	large
G0053654	x-large
G0053602	2x-large

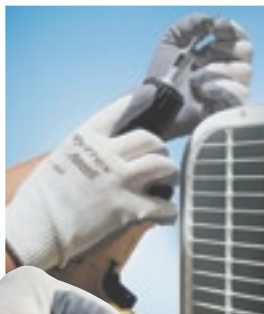
 pair **\$3.49**

**PIP**  
**MaxiFlex Palm-Coated Gloves**

- Nitrile coating with textured finish
- Nylon with lycra lining
- 15 gauge
- Continuous knit cuff
- ■ ANSI/ISEA ABRASION LEVEL 4

② #	size
G0053837	x-small
G0053846	small
G0053855	medium
G0053864	large
G0053873	x-large

 pair **\$3.54**

**CONDOR**  
**Palm-Coated Gloves**

- Natural rubber latex coating with crinkled finish
- Polyester/cotton lining
- Rolled cuff
- 10 gauge
- Resists grease and oils

② #	size
G0050967	small
G0050976	medium
G0050985	large
G0050994	x-large
G0050951	2x-large

 pair **\$3.79**

**HEXARMOR**  
**Level Six Series-9011 Palm Coated Gloves**

- Natural rubber latex coating with wrinkled finish
- High-performance polyethylene/SuperFabric lining
- Safety cuff
- Clute cut
- ■ ANSI/ISEA ABRASION LEVEL 4, CUT LEVEL 5, PUNCTURE LEVEL 4

② #	size
G0066446	small
G0066455	medium
G0066464	large
G0066473	x-large
G0066482	2x-large

 pair **\$15.49**



# SAFETY

MORE THAN 800,000 ITEMS ONLINE

### SHOWA BEST Disposable Nitrile Gloves

- Powder-free with pebbled finish
- 4 mil thick
- 9½" length
- Rolled/beaded cuff
- Industrial grade
- 100 pack

Z#	size
G0058694	x-small
G0058642	small
G0058651	medium
G0058667	large
G0058676	x-large
G0058685	2x-large

pack **\$6.96**



### ANSELL TNT Blue Disposable Nitrile Gloves

- Powder-free with textured finish
- 5 mil thick
- 9½" length
- Rolled/beaded cuff
- Food grade
- 100 pack

Z#	size
G0058782	small
G0058791	medium
G0058807	large
G0058816	x-large

pack **\$8.38**



### VALUE BRAND Glove Dispensers

- Enamel coated steel
- Wall or tabletop mount

Z#	dimensions	fits	price
G4101684	3½" w x 11" d x 3" h	1 box	<b>\$7.39</b>
G4105281	10½" w x 11" d x 4" h	2 boxes	<b>\$9.88</b>

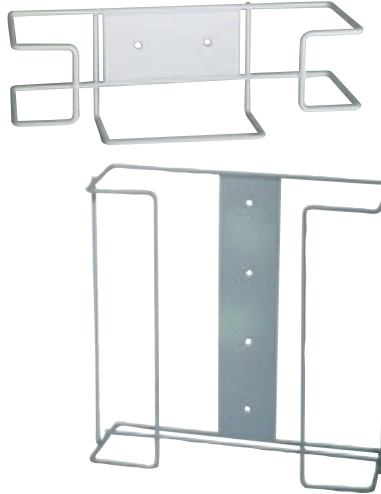

### ANSELL Touch N Tuff Disposable Nitrile Gloves

- Powder-free with smooth finish
- 5 mil thick
- 9½" length
- Rolled/beaded cuff
- Food grade
- 100 pack

Z#	size
G0058825	small
G0058834	medium
G0058843	large
G0058852	x-large

pack **\$11.22**



### ANSELL Chemical Resistant Latex Gloves

- 17 mil thick
- 12" length
- Pinked cuff
- Unlined

features good sensitivity and dexterity, high resistance to chemicals, snags, punctures and abrasion

Z#	size
G0024421	7
G0024437	8
G0024446	9
G0024455	10

pair **\$0.83**



### ANSELL Conform Disposable Latex Gloves

- Powdered with smooth finish
- 5 mil thick
- 9" length
- Rolled/beaded cuff
- Exam grade
- 100 pack

Z#	size
G0067785	small
G0067794	medium
G0067803	large
G0067812	x-large

pack **\$8.01**



### KIMBERLY-CLARK Professional Disposable Nitrile Gloves

- Powder-free with textured finish
- 6 mil thick
- 9½" length
- Rolled/beaded cuff
- Industrial grade

Z#	size	pack
G0068643	x-small	100
G0068652	small	100
G0068661	medium	100
G0068677	large	100
G0068686	x-large	90

pack **\$12.20**



### ANSELL Chemical Resistant Nitrile Gloves

- 15 mil thick
- Smooth finish
- 13" length
- Flock lining
- Straight cuff
- UNLINED AVAILABLE ONLINE

Z#	size
G0024096	9
G0024105	10

pair **\$1.75**



### SHOWA BEST Chemical Resistant Neoprene Gloves

- Heavy weight with rough finish
- Size 10
- Gauntlet cuff
- Flannel lining
- Protection against acids, caustics, oils, greases and many solvents

Z#	length	price/pair
G1458423	12"	<b>\$7.88</b>
G2219822	14"	<b>\$9.87</b>
G0531806	18"	<b>\$12.06</b>





**3M  
6000 Series Reusable Respirators  
and Accessories**

- 6000 series
- Adjustable strap
- Bayonet connection
- Dual cartridge configuration
- ■ NIOSH STANDARDS



- Full Facepiece**
- Silicone/thermoplastic elastomer facepiece
  - 4-point suspension

**Z #** price  
G2068184 **\$110.01**

**Half Facepiece**

- Thermoplastic elastomer facepiece
- Yolk and cradle suspension

**Small**

**Z #** price  
G3115183 **\$9.56**

**Medium**

**Z #** price  
G0497061 **\$9.56**

**Large**

**Z #** price  
G0952831 **\$9.56**



**Full Facepiece Lens Covers**

- For use with 6000 series
- 100 pack

**Z #** price  
G1569206 **\$133.43**



**Filter Cartridges**

- Color code yellow
- Approved for OV, AG
- Bayonet connection
- 2 pack
- ■ NIOSH APPROVED

**Z #** price  
G2800156 **\$10.33**



**3M  
General Industrial Disposable N95  
Particulate Respirators**

- Provides protection against certain non-oil based particles
- Noseclip
- Standard size
- ■ NIOSH STANDARDS

**Dual Elastic Head Strap**

- 20 pack

**Z #** price  
G0660974 **\$11.87**



**Dual Braided Head Strap**

- 10 pack

**Z #** price  
G2152001 **\$15.33**



**Dual Elastic Head Strap**

- 20 pack

**Z #** price  
G1842355 **\$10.88**



**Dual Elastic Head Strap**

- 10 pack

**Z #** price  
G4152951 **\$10.44**



**HONEYWELL  
Nuisance Dust Masks**

- Provides relief and protection for nuisance level particulate
- Elastic band headstrap
- Noseclip
- Universal size
- 50 pack

**Z #** price  
G2646752 **\$4.29**



**CONDOR  
Nuisance Removal Dust Masks**

- Elastic band headstrap
- Metal noseclip
- Universal size
- 50 pack

**Z #** price  
G0363781 **\$7.02**



**CONDOR  
Ratchet Faceshield Assembly  
with Chin Guard**

- Clear polycarbonate visor with plastic headgear
- 15½" w x 0.04" d x 7" h visor features locking arm system and (4) position adjustable visor stop
- ■ ANSI STANDARDS

**Z #** price  
G0291846 **\$25.27**



**VALUE BRAND  
Disposable Respirator Dispensers**

- Clear acrylic construction
- 6.25" w x 6.125" d x 12.5" h
- For use with disposable respirators and dust masks

**Z #** price  
G4128363 **\$60.57**



**CONDOR  
Ratchet Faceshield Assembly**

- Clear PCTG visor
- 15½" w x 0.07" d x 9" h visor
- Dielectric
- ■ ANSI STANDARDS features spark deflector with wide range of adjustability

**Z #** price  
G3223193 **\$16.88**





# SAFETY

## MSA V-Gard Front Brim Protective Hard Hats

- Polyethylene shell
- Accessory slots
- ANSI type 1
- Class E
- Fits hat size 6½ to 8
- ■ ANSI STANDARDS



### Pinlock Suspension

Z#	color
G0004331	blue
G0004356	orange
G0004374	white
G0004347	green
G0004365	red
G0004383	yellow

each **\$6.75**

### 4-Point Ratchet Suspensions

Z#	color
G0004435	blue
G0004462	orange
G0004487	white
G0004453	green
G0004471	red
G0004496	yellow

each **\$10.11**



## MSA HPE Cap-Mounted Earmuffs

- 27dB NRR
- Dielectric muffs
- Three wearing positions
- For use with hard hats
- ■ ANSI STANDARDS



Z#	price
G0436721	<b>\$23.93</b>

## HOWARD LEIGHT BY HONEYWELL Viking Series Ear Muffs

- Multi-position
- Dielectric and nonconductive ear muffs
- Padded headband

Z#	NRR	color	price
G2700171	29/27/27dB	gray	<b>\$18.73</b>
G0259761	27/25/25dB	blue	<b>\$14.57</b>



## 3M E-A-R UltraFit Corded Earplugs

- 25dB NRR
- Elastomeric polymer flanged plugs
- Universal size
- ■ ANSI STANDARDS



Z#	description	price
G1840605	earplugs only	<b>\$0.99</b>
G1660461	earplugs w/case	<b>\$1.39</b>

## MSA Skullgard Caps

- Phenolic shell
- Front brim
- Ratchet suspension
- Fits hat size 6½ to 8
- ■ ANSI STANDARDS



Z#	color
G0157263	natural tan
G0157272	white

each **\$75.08**

## MSA Officially Licensed NFL V-Gard Protective Caps

- Polyethylene shell
- Front brim
- Pinlock suspension
- Fits hat size 6½ to 8
- ■ ANSI STANDARDS



Z#	team
G0010367	chicago bears
G0010403	denver broncos
G0010577	seattle seahawks

each **\$23.47**



## MOLDEX SparkPlugs Disposable Ear Plugs

- 33dB NRR
- Polyurethane tapered plugs
- Individually wrapped pairs
- PVC free
- 200 pairs
- ■ ANSI STANDARDS

Z#	price
G0667046	<b>\$19.77</b>



## MSA Full Brim V-Gard Protective Hats

- Polyethylene shell
- 4-point ratchet suspension
- Fits hat size 6½ to 8
- ■ ANSI STANDARDS

Z#	color
G0009931	white
G0009922	blue

each **\$13.92**

## HOWARD LEIGHT BY HONEYWELL Disposable Ear Plugs

- Corded
- Polyurethane foam contoured plugs
- 100 individually wrapped pairs
- ■ ANSI STANDARDS



### MAX Ear Plugs

- Soft foam bell shaped plugs

Z#	NRR	price
G1499224	33dB	<b>\$21.72</b>

### Laser Lite Ear Plugs

Z#	NRR	price
G1802114	32dB	<b>\$20.61</b>



## eZ TIPS technical resources

### HEARING PROTECTION

It is estimated that approximately 30 million people in the U.S. are occupationally exposed to hazardous noise levels. One of the most common methods for minimizing worker exposure to these hazardous noise levels is the use of hearing protection. A wide variety of hearing protection is available, each with its own unique set of advantages and disadvantages. The most common types selected are described below.

#### NOISE REDUCTION RATING (NRR)

Hearing Protection is rated in NRR or Noise Reduction Rating. This is listed in dB, and is the maximum level of sound reduction the hearing protection will offer when worn.

decibel level (dB)	example of noise
140	rifle fire 1 meter away
120	sports game crowd noise
100	chain saw
90	drilling concrete, leaf blower
80	vacuum cleaner
50	floor fan

**3M Virtual Safety Eyewear**

- Wraparound, polycarbonate frame
- 99.9% UV protection
- Contoured temples
- Universal size
- ■ ANSI STANDARDS

Z#	color	type
G1030836	clear	uncoated lens
G1220816	clear	scratch-resistant lens
G1140867	gray	scratch-resistant lens

each **\$1.29**

**CREWS Clear Safety Eyewear**

- Scratch-resistant polycarbonate lens
- Universal size with frameless design
- 99.9% UV protection
- Spatula temples
- ■ ANSI STANDARDS

Z#	price
G2329546	<b>\$0.89</b>

**ELVEX Hard Hat Component Kit**

- ANSI Type 1
- Class E
- ■ ANSI STANDARDS
- includes earmuffs, bracket and visor*

Z#	price
G3967853	<b>\$60.42</b>

**NORTH BY HONEYWELL A700 Series Safety Eyewear**

- Scratch-resistant polycarbonate lens
- Clear wraparound frame
- 99.9% UV protection
- Soft temple tips
- ■ ANSI STANDARDS

Z#	price
G2784695	<b>\$1.58</b>

**CONDOR Safety Eyewear**

- Scratch-resistant polycarbonate lens
- Frosted clear wraparound frame
- 99.9% UV protection
- Padded bayonet temples
- ■ ANSI STANDARDS

Z#	price
G2890246	<b>\$2.67</b>

**UVEX BY HONEYWELL Stealth Splash Goggles**

- Polycarbonate clear antifog lens
- Indirect venting
- Gray polypropylene frame
- 99.9% UV protection
- ■ ANSI STANDARDS

Z#	price
G1323603	<b>\$7.89</b>

**JACKSON SAFETY V90 Monogoggle XTR Shield Splash Goggles**

- Polycarbonate clear antifog lens
- Indirect venting
- ■ ANSI STANDARDS
- includes blue face shield*

Z#	price
G2191831	<b>\$17.95</b>

**CONDOR Conforming Slip-On Sideshields**

- Clear plastic
- 99.9% UV protection
- Slips on to most plano-style protective eyewear
- ■ ANSI STANDARDS

Z#	price/pair
G1972354	<b>\$2.65</b>

**CHUMS Adjustable Eyewear Retainers**

- Adjustable to 28"
- Large end attachment
- 100% cotton

Z#	price
G0074794	<b>\$3.78</b>

**BAUSCH & LOMB Sight Savers Pre-Moistened Lens Cleaning Tissues**

- Antistatic formula
- 5" x 8" non-silicone tissues
- Individually wrapped tissues
- Wall mount
- 100 pack
- 5 3/8" w x 2 3/8" d x 9" h box

Z#	price
G2911772	<b>\$9.16</b>

**CONDOR Safety Glasses Holder**

- Clear acrylic
- Tray style
- 9" w x 6 3/4" d x 3 1/4" h
- Wall mount
- Holds up to 8 pairs

Z#	price
G3894913	<b>\$25.75</b>





# SAFETY

MORE THAN 800,000 ITEMS ONLINE

### CELLUCAP

#### Bouffant Caps

- Nylon-latex free elastic
- 21" dia
- Universal size
- 100 pack

#	price
G3919246	<b>\$4.49</b>



### CONDOR

#### Beard Covers

- Latex-free
- Stretchable fit for all-day comfort
- Universal size
- 100 pack



#### Lightweight Polypropylene

#	price
G2299351	<b>\$10.07</b>

#### Lightweight Nylon-Honeycomb

#	price
G1386761	<b>\$28.49</b>



### DUPONT

#### Slip Resistant Shoe Covers

- Tyvek with slip resistant sole
- Puncture and tear resistant
- Elastic top and serged seams
- Universal size
- 5.4 mil thick
- 200 pack

#	price
G0653597	<b>\$94.99</b>

### ANSELL

#### Natural Rubber Latex Gloves

- Embossed grip pattern for slip resistance
- Pinked cuff
- Moderate chemical resistance
- 12" length



See more chemical resistant gloves on page 8

#### FL-100 Series

- Cotton flock lining
- 17 mil thick

#	size
G0024534	7
G0024543	8
G0024552	9
G0024561	10

pair **\$0.69**

#### Canners & Handlers Series

- Unlined
- 20 mil thick

#	size
G0024613	7
G0024622	8
G0024631	9
G0024647	10

pair **\$0.99**



### VALUE BRAND

#### Hazmat Rubber Disposable Overboots

- Chemical resistant latex construction
- Textured sole for slip resistance
- Easily pull on and off
- Protects against acids, alcohol, salts and ketones



#	size
G0005582	8-9
G0005591	10-11
G0005607	12-13

pair **\$5.40**

### HEADLINE IT

#### Disposable Hard Hat/Helmet Liner

- Rayon/polyester blend
- Absorbs perspiration and wicks away moisture
- Self adhering glue strip secures liner to headwear
- 10 day average use
- Fits most bump caps, hard hats and helmets
- 10 pack

#	price
G3311612	<b>\$18.39</b>



### VALUE BRAND

#### Lightweight Disposable Gown

- Polyethylene construction
- Vented neck, open back and die-cut tiebacks
- Elastic cuff and thumb to loop extension
- 48" length
- Universal size
- 15 pack

#	price
G4080903	<b>\$13.99</b>



### SUNRISE

#### Disposable Lab Coats

- Multi-layer design
- Knit cuffs & snap front
- Three pockets
- Protects against non-hazardous particles
- Lightweight & breathable

#	size
G3833593	medium
G3833602	large
G3833611	x-large
G4748922	2x-large

each **\$1.75**



### CONDOR

#### Polypropylene Protective Coversalls

- Breathable, lightweight polypropylene
- Zipper front and serged seams
- Protects against non-hazardous dust and splash
- Transparent white
- 25 pack



#### Disposable Collared Coversalls

- Open cuffs & ankles

#	size
G0083097	medium
G0083106	large
G0083115	x-large
G0083124	2x-large
G0083133	3x-large
G0083142	4x-large
G0083151	5x-large

each **\$45.19**

#### Disposable Hooded Coversalls

- Elastic hood, cuffs & ankles

#	size
G0083255	medium
G0083264	large
G0083273	x-large
G0083282	2x-large
G0083291	3x-large
G0083307	4x-large
G0083316	5x-large

each **\$50.93**



### DUPONT Tyvek Collared Disposable Coveralls

- Zipper front
- Open ankle & cuff
- Comfort fit design for greater range of movement
- 6 pack
- 1.2 oz fabric weight
- ■ USDA, FDA, OSHA STANDARDS
- ► MORE SIZES AVAILABLE ONLINE

Q #	size
G0083876	medium
G0083885	large
G0083894	x-large

each **\$24.94**



### CONDOR Chemical-Resistant Apron

- PVC construction
- Abrasion & tear resistant
- Protects against chemicals, acids, oils, grease and animal fats
- 18 mil thick
- 35" x 50"

Q #	price
G0694382	<b>\$6.43</b>



### NATIONAL SAFETY APPAREL Protective Cryogenic Aprons

- Nylon Taslan/PTFE construction
- Adjustable neck/waist straps with quick disconnects
- Protects for ultracold environments (-260° to -300°F)
- Waterproof
- ■ EN 511/IFTH STANDARDS

Q #	size	price
G2375877	36" x 24"	<b>\$125.84</b>
G1429897	42" x 24"	<b>\$132.91</b>
G1784815	48" x 24"	<b>\$167.73</b>



### DUPONT Tyvek Disposable Collared Lab Coats

- Five snap front
- Two pockets
- Open cuffs
- Tear-resistant
- Serged seams
- 8 pack

Q #	size
G0084192	medium
G0084201	large
G0084217	x-large
G0085434	2x-large
G0085443	3x-large

each **\$30.86**



### CONDOR Premium Chemical-Resistant Aprons

- SBR rubber construction
- Black nitrile exterior with polyester interior
- Abrasion resistant
- Protects against chemicals, acids, oils, grease and animal fats
- 35" x 45"

Q #	thickness	price
G0817074	16 mil	<b>\$11.31</b>
G2277606	29 mil	<b>\$16.74</b>



### CONDOR 3-Piece Rainsuit

- PVC snap front jacket with hood
  - Bib overalls with snap-fly front
  - Nylon lining
  - Resists water, acids, alcohols, alkalis, salts, soil
  - 0.35 mm thick
- includes elastic suspenders*

Q #	size
G0076894	small
G0076903	medium
G0076912	large
G0076921	x-large
G0076937	2x-large
G0076885	3x-large

each **\$33.15**



### DUPONT Tyvek Disposable Protective Sleeves

- Elastic cuffs at both ends
- Serged seams
- 18" length
- Universal size
- 200 pack

Q #	price
G0929573	<b>\$66.35</b>



### CONDOR Cut Resistant Sleeves

- Stretch knit kevlar
- Thumbhole provides additional wrist protection
- Ambidextrous sleeves
- Universal size
- ■ ANSI/ISEA ABRASION LEVEL 2, CUT LEVEL 3

Q #	length	price
G1127691	10"	<b>\$2.35</b>
G2299954	14"	<b>\$5.45</b>
G2520086	18"	<b>\$14.29</b>
G0449321	24"	<b>\$14.29</b>



### TINGLEY Rain Bib Overalls

- Polyurethane with nylon liner
  - Resists water, alkalies, hydrocarbon oils, organic acids, organic solvents and salts
  - ■ ASTM STANDARDS
  - ► MORE RAIN GEAR AVAILABLE ONLINE
- includes heavy-duty elastic suspenders and premium snap-lock buckles*

Q #	size
G0154016	medium
G0154007	large
G0154034	x-large
G0153973	2x-large

each **\$37.77**



### VALUE BRAND Snake Gaiters

- Green plastic construction
- Protects against snakes, briars and vines
- 19" height in front
- 15" height in back

Q #	price/pair
G4332894	<b>\$33.76</b>





# SAFETY

MORE THAN 800,000 ITEMS ONLINE

### CONDOR Spandex Back Support

- Rubber track webbing
- 1½" adjustable elastic suspenders
- Hook and loop closure
- Universal size
- 9" bandwidth

#	price
G2292516	<b>\$18.55</b>

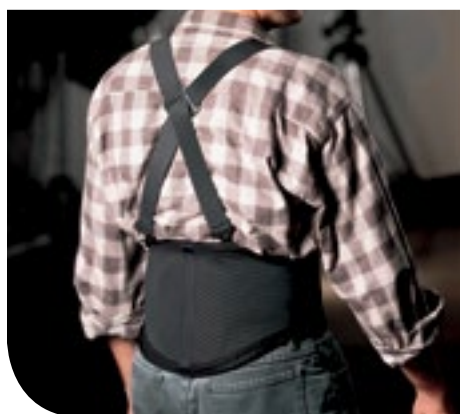

### OK-1 Contoured Back Support

- Elastic construction
- Adjustable lumbar support pad
- 1½" knit elastic suspenders
- Double overlap closure
- 9" width

#	size	waist size	price
G4639241	small	24" to 33"	<b>\$39.99</b>
G3850567	medium	29" to 38"	<b>\$39.99</b>
G3850551	large	35" to 44"	<b>\$39.99</b>
G3850576	x-large	42" to 52"	<b>\$39.99</b>
G3850585	2x-large	46" to 56"	<b>\$41.98</b>

### PROFLEX Anti-Vibration Gloves

- Chloroprene rubber palms
- Cotton/nylon back
- Knit cuff
- ANSI STANDARDS

#	size	price
G2873875	medium	<b>\$17.62</b>
G0670695	large	
G0870371	x-large	



### VALEO Single Strap Elbow Support

- Machine washable neoprene/nylon construction
- Terry lining
- Hook and loop closure
- Latex-free

#	size	fits	price
G3825561	small	8½-10"	<b>\$4.54</b>
G3825552	medium	10-11"	
G3825543	large	11-12"	
G3825577	x-large	12-13½"	

### VALEO Pull-Over Elbow Support

- Lightweight neoprene construction

#	size	fits	price
G3854514	small	8½-10"	<b>\$8.10</b>
G3854505	medium	10-11"	
G3854496	large	11-12"	
G3854523	x-large	12-13½"	



### DECADE Slip-On Wrist Support

- Cotton/rayon blend
- Seamless construction
- Ambidextrous fit
- Can reduce pain from minor wrist sprains and strains

#	size	fits	price
G3962427	small	5½-6½"	<b>\$9.11</b>
G3952916	medium	6¾-7½"	
G3980785	large	7¾-8½"	
G4057575	x-large	over 8½"	



### CLC Injected Gel Kneepads

- TPE cap
- EVA foam pad construction
- Quick release hook and loop closures
- Two elastic/neoprene straps
- One size fits most

#	price/pair
G2429551	<b>\$40.01</b>



### CLC Swivel Knee Pads

- Poly pro cap construction
- EVA foam pad and two elastic straps
- Quick release hook and loop closures
- Non-skid
- One size fits most

#	price
G3204372	<b>\$15.62</b>



### OK-1 Carpal Tunnel Wrist Support

- Neoprene construction
- 3" wide wraparound strap
- Terry cloth lining
- Hook and loop closure

#### Right Wrist

#	size	fits	price
G3850201	medium	6½-7½"	<b>\$19.94</b>
G3850192	large	7½-8½"	

#### Left Wrist

#	size	fits	price
G3850174	medium	6½-7½"	<b>\$19.94</b>
G3850183	large	7½-8½"	



**IMPACTO METGUARD Metatarsal Guard**

- Non-conductive polycarbonate construction
- Attaches using existing laces
- 75 lb minimum impact resistance
- Universal size
- 5" x 4"
- ■ ASTM STANDARDS

#	price/pair
G1679377	<b>\$22.79</b>



**VALUE BRAND Steel Toe Guard**

- 75 lb impact resistance
- 12 oz each
- Universal size
- 4 1/2" wide

#	price/pair
G2737594	<b>\$29.99</b>



**5.11 TACTICAL Moisturizing Wicking Boot Sock**

- Coolmax/nylon/spandex/rubber blend
- Cushioned sole
- Crew height
- Fits sizes 9-12

#	price/pair
G3549183	<b>\$12.99</b>

**VALUE BRAND Boot Scraper**

- Polypropylene bristles
- 6" w x 9" l x 5" h

**Standard Scraper**

#	price
G0502512	<b>\$29.67</b>

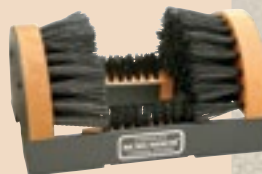

**Replacement Brush Set**

#	price
G4056184	<b>\$12.89</b>



**ONGUARD PVC Knee Boots**

- Steel toe
- Slip resistant cleated sole
- Waterproof
- 16" height
- ■ ANSI STANDARDS

#	size	price/pair
G0005241	8	<b>\$12.95</b>
G0005257	9	
G0005196	10	
G0005205	11	
G0005214	12	
G0005223	13	



**TINGLEY Pull On Overshoes**

- Natural rubber construction
- Slip resistant cleated sole
- Resists acids, alcohols, bases and diluted water solutions

#	size	price/pair
G0008014	6.5-8	<b>\$14.29</b>
G0007971	8-9.5	
G0007962	9.5-11	
G0007987	11-12.5	
G0007996	12.5-14	
G0008005	14-15.5	

pair **\$14.29**

**BULWARK Excel FR Coveralls**

- Flame resistant 100% cotton
- Zipper front, snap closure at wrists and ankles
- Five pockets
- HRC2 rating
- ■ ASTM, NFPA STANDARDS



#	size	price/each
G0034054	medium	<b>\$46.80</b>
G0034072	large	
G0034097	x-large	
G0034115	2x-large	

**CONDOR Flame Resistant Jackets**

- Durable preshrunk cotton construction
- Snap front and sleeve closure
- Inside pocket
- ■ ASTM STANDARDS



#	size	price/each
G0075476	medium	<b>\$30.70</b>
G0075485	large	
G0075494	x-large	
G0075503	2x-large	
G0075512	3x-large	

**NATIONAL SAFETY APPAREL Flame Resistant Hood**

- UltraSoft fabric
- Covers the head, face and neck
- One size fits most
- HRC2 rating

#	price
G3329566	<b>\$21.29</b>





# SAFETY

MORE THAN 800,000 ITEMS ONLINE

### MIRA COOL Western Style Cooling Wrap

- Cotton with water activated beads
- 10 to 20 min soaking time
- Universal size
- ► MORE PATTERNS AVAILABLE ONLINE

Z#	price
G2262434	<b>\$1.64</b>



### CONDOR Deluxe Sweatband

- Cellulose sponge construction keeps you dry and comfortable
- Stitched elastic band
- 100 pack

Z#	price
G3477363	<b>38.75</b>



### ERGODYNE Chill-Its Headwear and Sweat/Wristbands

- Terry cloth construction
- Absorbent and moisture wicking
- Universal size

#### Wristbands

Z#	color	price
G1367764	black	<b>\$1.15</b>
G1665264	white	



#### Headbands

Z#	color	price
G1981271	black	<b>\$1.15</b>
G1205136	white	



### ERGODYNE Cooling Hats

- Absorbent terry cloth construction
- Moisture wicking
- Can be worn alone or with hats/helmets
- Universal size
- ► MORE AVAILABLE ONLINE

Z#	size	style	price
G3089642	medium	western	<b>\$5.19</b>
G2823432	large	stars and stripes	

each



### CONDOR Ranger Style Sun Protection Hats

- Polyester with mesh venting panels
- Wear alone or under hard hats
- Hi-Vis lime
- ■ ANSI STANDARDS

Z#	size	price
G4798516	small/medium	<b>\$13.69</b>
G4798525	large/x-large	

each



### CONDOR Hard Hat Cooling Pad

- Neck shade
- Cotton with water activated beads
- Cools by evaporation
- Can be worn alone or with hard hats
- includes webbing and hook-and-loop fastening tape

Z#	price
G4798631	<b>\$5.58</b>



### CARHARTT Short Sleeve Henley

- 100% cotton
- Three button collar
- Left chest pocket
- ► MORE SIZES AVAILABLE ONLINE

Z#	size	price
G0094211	medium	<b>\$16.99</b>
G0094202	large	
G0094227	x-large	
G0094236	2x-large	

each



### VF WORKWEAR Short Sleeve Coveralls

- 65% polyester/35% cotton twill blend
- Durable fabric with soil release and wickable finish
- Zipper front
- Six pockets
- ► MORE SIZES AVAILABLE ONLINE

Z#	size	chest size	price
G3837337	large	42-44"	<b>\$36.39</b>
G3837312	x-large	46-48"	<b>\$36.39</b>
G3837303	2x-large	50-52"	<b>\$43.36</b>
G3837321	3x-large	54-56"	<b>\$47.80</b>

each



### PUMA Composite Toe Athletic Work Shoes

- Leather/suede upper, rubber shank and outsole
- BreathActive lining
- Cushioned midsole and heel
- Antimagnetic, static dissipative and slip-resistant
- ■ ASTM STANDARDS

Z#	size	price
G0222537	8	<b>\$117.04</b>
G0222546	9	
G0222467	10	
G0222476	11	
G0222485	12	
G0222494	13	

pair





**HEAT FACTORY  
Hand Warmers**

- Up to 10 hr heating time
- Air-activated
- Provides 124° F comfort
- Easily slip into pockets, gloves, or headwear
- 3 pack



#	price
G3412421	<b>\$2.04</b>

**HEAT FACTORY  
Heated Face Mask**

- Fleece
- Black
- Over the head design
- Covers lower face and ears
- Universal size



#	price
G4185955	<b>\$17.01</b>

**MAXIT  
Thermal Hats**

- Stretchable ProMax IV construction
- Non-allergenic
- Moisture-wicking
- Wear alone or as a liner
- Universal size



#	color
G0218066	black
G0218084	blue
G0218075	brown

each **\$12.59**



**CONDOR  
Hard Hat Earbands**

- Acrylic construction
- Snug fit around the ears and top of the head
- Fits over most hard hats
- Universal size

#	color
G2236026	blue
G3047642	orange

each **\$4.46**



**ANSELL  
Winter Monkey Grip Gloves**

- Vinyl coated PVC outer material
- Foam insulate lining keeps hands warm and dry
- Protects up to -50° F
- Clute cut
- Wing style thumb

#	coating	price/pair
G1288515	textured	<b>\$9.91</b>
G2503182	smooth	<b>\$11.90</b>



**MECHANIX WEAR  
Winter Armor Gloves**

- Rubberized synthetic leather front
- Deerskin leather back
- Fleece/thinsulate lining
- Safety cuff
- Protects 0° to 200° F
- Gunn cut with straight thumb

#	size
G3839586	medium
G3839595	large
G3839604	x-large
G3839613	2x-large

pair **\$20.71**



**STABILICERS  
Traction Gear Ice Cleats**

- Full foot slip protection
- Thermoplastic elastomer construction
- Easily pull on/off
- Fits over shoes or boots

#	size
G4329936	medium
G4329927	large
G4329911	x-large

pair **\$19.54**



**CARHARTT  
Thermal Lined Men's Duck Active Jacket**

- 100% ring spun cotton duck
- 100% polyester thermal lining
- Attached thermal hood with drawcord
- Two outside pockets, two inside pockets
- **▶ MORE SIZES AVAILABLE ONLINE**

**Brown**

#	size	chest size
G0087123	small	34" to 36"
G0087114	medium	38" to 40"
G0087105	large	42" to 44"
G0087132	x-large	46" to 48"
G0087096	2x-large	50" to 52"



**Black**

#	size	chest size
G0087071	small	34" to 36"
G0087062	medium	38" to 40"
G0087053	large	42" to 44"
G0087087	x-large	46" to 48"
G0087044	2x-large	50" to 52"

each **\$69.99**



**CARHARTT  
Men's Arctic-Quilt Lined Sandstone Vest**

- 100% cotton sandstone duck
- Nylon quilt lining
- Back drop tail for added coverage
- Two pockets outside, one pocket inside
- Brass front zipper with inside storm flap
- **▶ MORE SIZES AVAILABLE ONLINE**

#	size	chest size
G0096494	medium	38" to 40"
G0096485	large	42" to 44"
G4638137	x-large	46" to 48"

each **\$59.99**



**CONDOR  
Insulated Coveralls**

- 65% polyester/35% cotton outer material
- 57% polyester/43% nylon lining
- Water-repellent
- Six outside pockets
- Zipper front

#	size	chest size
G0096433	medium	48"
G0096442	large	52"
G0096451	x-large	56"
G0096467	2x-large	57"
G0096476	3x-large	59"

each **\$142.98**



**eZTIPS**  
technical resources

eZTips about these products are available online at [zoro.com/eztips](http://zoro.com/eztips)



# SAFETY

## PROTECTA Full Body Construction Harness

- Forged stamped steel hardware
  - Polyester webbing
  - 420 lb capacity
  - ■ ANSI, OSHA STANDARDS
- includes hip pad and subpelvic strap*

Z#	size	price
G1438972	small	<b>\$74.34</b>
G1320821	medium/large	
G0277216	x-large	



## PROTECTA Pro Body Belts

- Polyester webbing
  - Tongue buckle and side D-rings
  - Two anchor points
  - ■ OSHA, ANSI, CSA STANDARDS
- includes body pad and tool rings*

Z#	size	waist	price
G0996947	small	32" to 40"	<b>\$89.19</b>
G2516403	medium/large	36" to 48"	
G1265591	x-large	44" to 52"	



## PROTECTA Self-Retracting Lifelines

- Anodized aluminum housing
- Polyester line
- External energy absorber brake system
- 310 lb capacity
- ■ ANSI, OSHA STANDARDS

Z#	length	shrink tubing	price
G1493931	11'	without PVC	<b>\$127.85</b>
G3150007	20'	with PVC	<b>\$257.96</b>



## MILLER BY HONEYWELL Manyard Shock-Absorbing Lanyard

- Steel hardware with polyester line
- Shock-absorbing woven inner core
- 310 lb capacity
- 6' length
- ■ ANSI, OSHA STANDARDS

Z#	price
G2792937	<b>\$67.41</b>

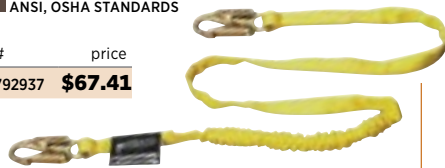

## ERGODYNE Tool Lanyard

- Aluminum hardware
- Nylon tubular elastic line
- 10 lb max working load
- 35" to 42" length

Z#	price
G0943363	<b>\$6.28</b>



## CONDOR Fall Protection Kit

- Alloy steel hardware
  - Construction and general maintenance applications
  - 310 lb capacity
  - Universal size
  - ■ ANSI, OSHA STANDARDS
- includes five point full body harness, 6' detachable shock absorbing lanyard with internal style energy absorber, soft sided storage bag and protective label cover*

Z#	price
G4538861	<b>\$80.50</b>



## MILLER BY HONEYWELL Nonstretch Full-Body Harness

- Carbon steel hardware
- Polyester webbing
- Back and shoulder pads for additional comfort
- 400 lb capacity
- Universal size
- ■ ANSI, CSA, OSHA STANDARDS

Z#	price
G2735722	<b>\$155.06</b>

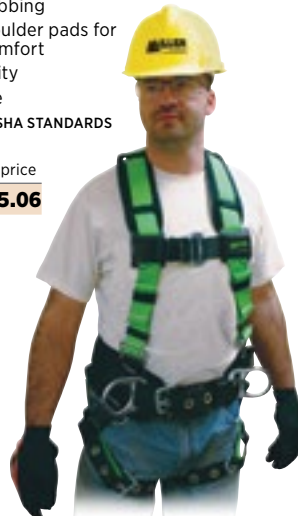

## DBI-SALA Sliding Beam Anchor

- Fits 3 1/2" to 14" diameter beams
- 420 lb capacity
- 1" ring
- 4 1/4" x 19 1/8"
- ■ OSHA, ANSI STANDARDS

Z#	price
G1051872	<b>\$179.45</b>



## NOTRAX Knee RX Kneeling Pads

- Nitrile/PVC sponge blend
- Built-in handle
- Use when kneeling on tile, carpeting, wood, concrete or metal grating
- Heavy duty version includes rubber backing for added protection
- 12" w x 22" l x 1" h

Z#	type	price
G2996384	standard	<b>\$20.08</b>
G0593871	heavy duty	<b>\$26.09</b>



## GUARD-TEX Self Adhering Safety Tape

- Cotton gauze material
- Self-adhesive
- Non-allergenic
- 3/4" x 30 yd roll
- 16 pack

Z#	price
G3787052	<b>\$16.53</b>



**INDUSTRIAL NOISE**

**Noise Absorbing Wall Blanket**

- Abrasion resistant fiberglass
- Eliminates noise and echo in industrial environments
- Impervious to water, dust, oil, grease and most solvents
- 4' x 8'
- Noise reduction coefficient 0.75
- ■ ASTM E84 STANDARDS



Z#	price
G0985521	<b>\$166.73</b>



**INDUSTRIAL NOISE**

**Portable Acoustic Screen**

- Tubular steel frame with reinforced vinyl barrier and absorber curtain
- Forms partial noise barrier
- Resists moisture, lubricants, fuels, grease and solvents
- 4' x 8'
- Noise reduction coefficient 0.75
- ■ ASTM E84 STANDARDS



Z#	price
G0454413	<b>\$461.44</b>



**VALUE BRAND Barricade Tape**

- Polyethylene
- Identifies hazards and outlines restricted areas
- 3" x 1000' roll
- 2 mil thickness
- ■ OSHA STANDARDS

Z#	legend
G2363934	<i>danger</i>
G1194207	<i>caution</i>

each **\$5.50**



**CORTINA**

**Reflective Pavement Marking Tape**

- Glass bead coated engineering grade paper with foil backing
- Adheres to asphalt or concrete
- Peel and stick application
- 4" x 150' roll
- 12 mil thickness
- Meets federal and state requirements where applicable



Z#	color
G3364225	<i>white</i>
G1316655	<i>yellow</i>

each **\$44.76**

**VALUE BRAND Floor Marking Tape**

- Solid vinyl
- 2" x 108' roll
- 5 mil thickness
- 3" core size
- ■ ASTM STANDARDS



Z#	color
G1588413	<i>yellow</i>
G0629921	<i>red</i>
G2905427	<i>blue</i>

each **\$3.88**

**VALUE BRAND Fluorescent Flagging Tape**

- PVC
- 1 3/8" x 150' roll
- 4 mil thickness
- ■ OSHA STANDARDS

Z#	color
G0929923	<i>fluorescent orange</i>
G2454873	<i>fluorescent pink</i>
G0395105	<i>fluorescent lime</i>
G3497891	<i>fluorescent red</i>
G3199865	<i>fluorescent blue</i>

each **\$0.74**



**VALUE BRAND**

**Brass Stencil Set**

- Interlocking characters
  - For use with spray or brush-on paint
  - 92 piece set
  - Character height 3"
- includes letters, numbers and symbols*

Z#	price
G2342252	<b>\$98.49</b>



**VALUE BRAND Economy Floor Tape Applicator**

- Tubular steel
- Plastic handle grips
- For use with 1" to 4 1/2" wide rolls
- 3" core size

Z#	price
G1187076	<b>\$102.58</b>

**WOOSTER PRODUCTS Flex-Tred Antislip Tape**

- Oxide coarse grit with vinyl adhesive
- 4" x 60' roll
- ■ ASTM, ADA STANDARDS

Z#	price
G1739141	<b>\$38.58</b>



**SCOTCH Safety Stripe Warning Tape**

- Rubber/vinyl
- 2" x 108' roll
- 5.4 mil thickness
- 4 1/2" core size
- ■ OSHA, ANSI STANDARDS

Z#	color
G4309225	<i>black/yellow</i>
G4309234	<i>black/white</i>

each **\$45.44**





# SAFETY

MORE THAN 800,000 ITEMS ONLINE

### WEARWELL Smart Diamond-Plate Anti-Fatigue Mats

- Recycled urethane
- Beveled edges
- 1" thick
- MINIMUM 50% POST-CONSUMER RECYCLED CONTENT

Z#	size	price
G3732032	2' x 3'	<b>\$29.27</b>
G3714173	3' x 5'	<b>\$68.21</b>

### WEARWELL Anti-Fatigue Drainage Mats

- Natural rubber
- Black
- MINIMUM 30% POST-CONSUMER RECYCLED CONTENT

Z#	size	thick	edges	price
G1331391	2' x 3'	3/8"	straight	<b>\$46.17</b>
G2320543	3' x 5'	1/2"	beveled	<b>\$54.36</b>
G0456057	3' x 5'	3/8"	straight	<b>\$75.85</b>

### NOTRAX Interlocking Anti-Fatigue Mats

- Interlocking edges
- Nitrile rubber
- 3/4" thick
- Black

Z#	size	surface pattern	properties	price
G2923277	3' x 3'	solid top with grit	grease resistant	<b>\$123.75</b>
G2653567	3' x 3'	drainage holes	anti-slip	<b>\$128.38</b>
G1437536	3' x 5'	drainage holes	anti-slip	<b>\$200.97</b>

### WEARWELL Modular Mats and Edging

#### Modular Interlocking Flooring System

- Interlocking edges
- 3' x 3'
- 3/8" thick
- Black

Z#	material	surface pattern	price
G4894757	CFR rubber	slightly textured	<b>\$84.55</b>
G4897627	nitrile rubber	drainage holes	<b>\$131.21</b>

#### Safety Edging

- CFR rubber
- 3" x 3/4"
- 3/8" thick
- Yellow edge

Z#	locking structure	price
G3179197	male	
G0553472	female	
each		<b>\$23.75</b>

### APACHE MILLS Black with Yellow Chevron Border Anti-Fatigue Mat

- Vinyl with PVC foam backing
- Diamond plate surface pattern
- Beveled edges
- 1 1/8" thick
- 3' x 5'

Z#	size	price
G3789886		<b>\$111.45</b>



### NOTRAX Ribbed Anti-Fatigue Mats

- PVC closed cell sponge
- Beveled edges
- 3/8" thick
- Black

Z#	size	price
G2704274	2' x 3'	<b>\$10.76</b>
G1297204	3' x 5'	<b>\$25.46</b>

### NOTRAX Ribbed Anti-Fatigue Runners

- PVC closed cell sponge
- Beveled edges
- 3/8" thick
- Black

Z#	size	price
G0721131	2' x 60'	<b>\$211.18</b>
G1449594	3' x 60'	<b>\$251.68</b>

### NOTRAX Anti-Fatigue Runners

- PVC sponge
- Beveled edges
- Diamond plate surface pattern
- 1/2" thick
- Black

Z#	size	price
G1809297	3' x 12'	<b>\$95.02</b>
G2383446	3' x 60'	<b>\$617.95</b>



### NOTRAX #419 Diamond Sof-Tred Anti-Fatigue Mat and Runner

- Diamond plate surface pattern
- PVC sponge
- Beveled edges
- 1/2" thick
- Black with yellow border

Z#	size	item	price
G1271076	3' x 5'	mat	<b>\$41.18</b>
G2660034	3' x 12'	runner	<b>\$105.85</b>

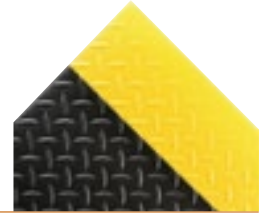

### NOTRAX #979 Saddle Trax Anti-Fatigue Mat and Runner

- Vinyl with PVC foam backing
- Diamond plate surface pattern
- Beveled edges
- 1" thick
- Black with yellow border
- OSHA STANDARDS

Z#	size	item	price
G2622146	3' x 5'	mat	<b>\$163.80</b>
G0914627	3' x 12'	runner	<b>\$432.40</b>

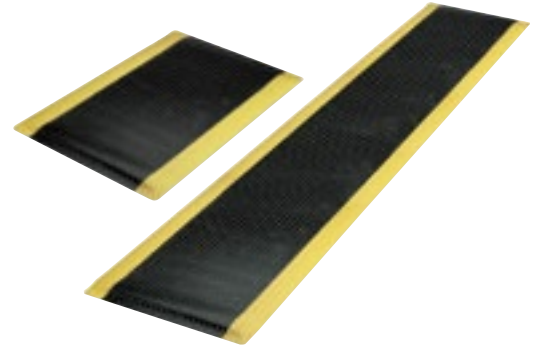

### NOTRAX #479 Cusion Trax Anti-Fatigue Mat

- PVC with PVC sponge backing
- Diamond plate surface pattern
- Beveled edges
- 3/8" thick
- 3' x 5'
- OSHA STANDARDS

Z#	price
G1126483	<b>\$128.28</b>



**RUBBERMAID  
Pop-Up Safety Signs**

- Nylon
- Text and symbol "Caution" legend
- 21" width
- 21" height
- ■ ANSI STANDARDS

includes English, Spanish and French

Z#	height	price
G3451655	20"	<b>\$25.74</b>
G1645874	30"	<b>\$36.09</b>



**BRADY  
Warning Posts**

- Polyethylene
- Nonconductive and nonrusting
- 41" height
- 16" base

Z#	color	pack	price
G1559144	yellow	1	<b>\$71.10</b>
G3301584	striped	6	<b>\$585.74</b>

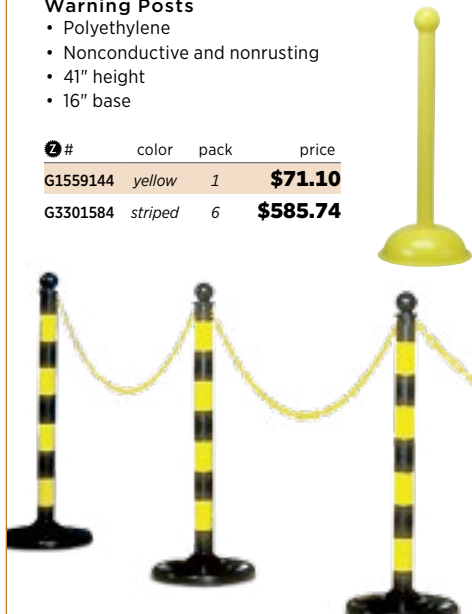

**ULTRATECH  
Drain Seal**

- Urethane
- 3/8" thick
- 18" x 18"
- ■ SPCC, NPDES STANDARDS

Z#	price
G1227965	<b>\$66.95</b>



**BRADY  
Magnetic Drain Cover**

- Strong magnetic vinyl
- .024" to .025" thick
- 24" x 24"

Z#	price
G3942802	<b>\$54.71</b>



**VALUE BRAND  
Roof Leak Diverter**

- Polyethylene
  - Hangs by corners
  - 5' x 5'
- includes standard 3/4" garden hose connection and steel rings in each corner

Z#	price
G4316627	<b>\$29.22</b>



**SEE ALL INDUSTRIES  
Indoor Convex Mirrors**

- Glass lens
  - Hardboard backing
  - Metal rim
  - 160° viewing angle
- includes mounting bracket and hardware

Z#	diameter	price
G3938593	18"	<b>\$31.50</b>
G3962761	26"	<b>\$57.89</b>
G4051074	30"	<b>\$85.95</b>

**BRADY  
Warning Chains**

- Polyethylene
- Indoor use only
- 100' length
- ► MORE AVAILABLE ONLINE

Z#	price
G1234091	<b>\$208.68</b>

**RUBBERMAID  
Plastic Safety Cones**

- Text and symbol legend
- Multi-lingual
- 36" height
- ■ OSHA STANDARDS

Z#	legend	price
G2679031	safety first	<b>\$35.54</b>
G2464357	caution	
G3088373	wet floor	



**RUBBERMAID  
Over-the-Spill Pad Tablet**

- Medium weight absorbs universal/maintenance fluids
  - Perforated for easy tear off
  - Absorbs 12 oz per pad
  - 16 1/2" x 14"
- includes (20) pads per tablet

Z#	price
G1378377	<b>\$19.62</b>





# SAFETY

MORE THAN 800,000 ITEMS ONLINE

### EAGLE Modular Drum Platforms

- Polyethylene interlocking design
- Holds 2 drums
- 30 gal spill capacity
- 5,000 lb load capacity
- 51½" w x 26¼" l x 6½" h
- ■ EPA STANDARDS

Z#	price
G1116193	<b>\$84.02</b>

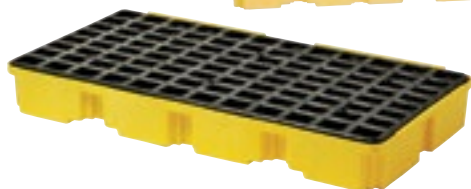

See more drum equipment on page 204

### EAGLE Drum Spill Containment Pallet

- Chemical-resistant HDPE
- Holds (4) drums
- 66 gal spill capacity
- 8,000 lb load capacity
- 51½" w x 51½" l x 8" h
- ■ EPA STANDARDS

Z#	price
G0975572	<b>\$196.69</b>



### OIL-DRI Premium Universal Absorbent

- All-natural clay formula with less dust
- Absorbs non-aggressive fluids such as oil, grease, and water
- 3.8 gal volume absorbed per bag
- 40 lb bag

Z#	price
G0927586	<b>\$8.45</b>



### OIL-DRI Universal/Maintenance Sorbent Socks

- Polypropylene with bonded coversock
- General purpose cleanup of aggressive/non-aggressive spills
- 12 gal volume absorbed per sock
- 3" x 4'
- 12 pack

Z#	price
G1637702	<b>\$31.69</b>



### STARDUST Quick Response II Spill Kit

- Absorbs universal/maintenance fluids
- 15" x 21" carrying bag
- 6 gal volume absorbed per kit
- includes (15) 16" x 18" pads, (2) 3" x 4' socks, (2) nitrile gloves, (2) disposable bags and instruction sheet*

Z#	price
G1375613	<b>\$35.99</b>

### BRADY SPC ABSORBENTS General Purpose Absorbent Pads

- Polypropylene perforated pads
- Absorbs all water, petroleum, and chemical-based fluids
- 15" x 19"
- 100 pack

Z#	type	absorbency	price
G0535875	light weight	22 gal per pack	<b>\$35.31</b>
G0305094	heavy weight	30 gal per pack	<b>\$58.25</b>



### CHEMSORB Portable Decontamination Kit

- 12½" w x 12½" l x 14½" h
- ■ EPA STANDARDS
- includes water containers, portable eyewash, soap, towels, coveralls and carry case*

Z#	price
G4078873	<b>\$117.80</b>



### VALUE BRAND Decon Shower Sponge

- HDPE handle
- 3" x 5" sponge
- 14" total length

Z#	price
G4013511	<b>\$9.15</b>



### BRADY SPC ABSORBENTS MRO Plus Absorbent Pads

- Heavy weight 3-ply perforated pads
- Absorbs all water, petroleum, and chemical-based fluids
- 26 gal absorbed per pack
- 15" x 19"
- 100 pack

Z#	price
G1424306	<b>\$52.49</b>



### OIL-DRI Oil Only Absorbent Pads

- Heavy weight polypropylene
- Absorbs oil-based fluids while repelling water
- 26 gal absorbed per pack
- 15" x 19"
- 100 pack

Z#	price
G3303772	<b>\$59.88</b>





### HONEYWELL Fendall Pur Flow 1000

#### Station

- 7 gal capacity
- Wall or cart mount
- Pull tray activation
- 29" w x 23" d x 30" h

• ■ ANSI/SEI STANDARDS  
includes mounting bracket  
and sign

② # price  
G2478515 **\$314.85**

#### Refill-cartridges

② # size price  
G1000903 2-pack **\$122.95**



### HONEYWELL Eyesaline Wall Station

#### Station

- Open-face design readily available for emergency flushing and decontamination
- Holds (1) 16 oz bottle
- 7" w x 5" d x 13½" h

• ■ ANSI STANDARDS  
includes extended  
flow nozzle

② # price  
G2934976 **\$20.75**

#### 16 oz refill bottle

② # price  
G0377711 **\$6.98**



### HONEYWELL Dual Eyewash Station

#### Station

- (2) 32 oz bottle capacity
- 18" w x 5" d x 14" h

• ■ ANSI STANDARDS  
includes extended flow nozzle

② # price  
G1731195 **\$34.99**

#### 32 oz Replacement Eye Wash Bottle

② # price  
G2425351 **\$10.86**



### GUARDIAN Portable Eye Wash Station

- Stainless steel tank with 15 gal capacity
- 0.4 gpm flow
- Chrome-plated brass stay-open ball and squeeze valves
- 39" h x 16" dia

• ■ ANSI STANDARDS  
includes 8 oz bacteriostatic  
additive (G1540BA),  
ANSI-compliant  
identification  
sign, inspection tag  
and instructions

② # price  
G3692071 **\$694.76**



### GUARDIAN Portable Eye Wash Unit

#### Station

- 16 gal capacity
- Wall or counter mount
- Gravity fed activation
- 21¼" w x 18¼" d x 20¼" h

• ■ ANSI STANDARDS  
includes hi-vis identification signs, bottle of bacteriostatic  
additive, drain tube, wall bracket and inspection tag

② # price  
G1214446 **\$179.70**

#### Eye Wash Preservative

- 8 oz
- 6-20 gal yield per bottle

② # price  
G1902126 **\$8.38**



### GUARDIAN Dual Head Drench Hose

#### Station

- Countertop mount
- 8' reinforced PVC hose
- 3.2 gpm flow rate
- ¾" NPT inlet

• ■ ANSI STANDARDS  
includes mounting hardware,  
identification sign and inspection tag

② # price  
G0696446 **\$205.88**

#### Replacement Spray head

• ¼" NPT inlet, GS  
② # price  
G1921446 **\$14.86**



### GUARDIAN Drench Shower With Eyewash Station

- Free standing
- Flag push handle eyewash activation
- Pull handle shower activation
- 16" w x 96" h
- 1¼" fitting
- ■ ANSI STANDARDS

② # price  
G1495471 **\$519.45**



### GUARDIAN Wall Mount Eyewash Station

- (2) heads
- Plastic bowl with aluminum handles
- Flag push handle activation
- Chrome plated brass ½" NPT female fitting
- 15½" w x 13¾" d x 9" h

② # price  
G0498635 **\$158.25**



### GUARDIAN Faucet Mount Eyewash Station

- (2) heads
- Chrome plated brass with aluminum handles
- Pull knob activation
- 5/8"-27 female fitting
- 4¼" w x 2¼" d x 3½" h
- ■ ANSI STANDARDS

② # price  
G0905877 **\$55.26**





# SAFETY

## CURAD Mini First Aid Kit

- Supplies for 1 to 2 people
- Easily portable case



Z#	price
G4154446	<b>\$1.51</b>

## FIRST AID ONLY First Aid Kit

- Materials for up to 25 people
- Plastic case
- Portable
- Contains bulk supplies that are readily accessible
- Ideal for manufacturer settings where a wide variety of first aid items are needed



Z#	price
G0251377	<b>\$15.73</b>

## NORTH BY HONEYWELL First Aid Kit

- Materials for up to 75 people
- Waterproof plastic case
- Portable or wall mount
- Contain bulk supplies that are readily accessible

• **ANSI STANDARDS**  
includes (146) adhesive bandages, (12) burn treatment packs, (5) eye treatment packs and (36) medicinals



Z#	price
G1855524	<b>\$56.79</b>

## MEDI-FIRST First Aid Cabinet

- Supplies for 150 people
- Wall mount or portable
- Metal case



Z#	price
G2924704	<b>\$124.73</b>

## AMERICAN RED CROSS Emergency Preparedness Kit

- Red nylon case
- includes fundamental supplies needed to address various emergency situations



Z#	price
G1423326	<b>\$18.39</b>

## TECNU Skin Cleanser

- 32oz bottle
- Provides protection against poison oak, ivy, and sumac



Z#	price
G4003772	<b>\$12.39</b>

## CUMBERLAND SWAN Rubbing Alcohol

- 1gal bottle
- 70% isopropyl alcohol



Z#	price
G4479151	<b>\$38.26</b>

## AMERICAN RED CROSS Pocket CPR Mask

- Universal size
- Disposable
- Plastic clamshell case
- includes one-way valve, non-latex gloves, instruction guide and clamshell case



Z#	price
G4816752	<b>\$30.26</b>

## AMERICAN RED CROSS CPR/AED Prep Kit

- Materials for up to 2 people
- includes cpr face shield, (4) latex free vinyl gloves, (2) BZK antiseptic towelettes, (2) antimicrobial wipes, (2) 4" x 4" gauze dressing pads, 7/8" utility shear, razor, 0.9 g hand sanitizer pack, 24" x 24" biohazard bag, twist tie and how-to-use guide

Z#	price
G1400953	<b>\$21.82</b>



## RAPID AID Hot/Cold Pack

- Reusable
- Waterproof
- 4" x 6"



Z#	price
G4188947	<b>\$1.28</b>

## MAGNUM MEDICAL EMT Utility Scissors

- 7 1/2" length
- Plastic handle
- Rounded stainless steel blade
- Angled scissors designed to remove bandages close to the skin
- Serrated edges to help cut through tough materials



Z#	color
G4096294	orange
G4095813	blue
G4223511	magenta
G4053472	purple
G4230326	red
G4141733	teal
G4016031	yellow

each **\$2.83**



## BAXTER Sterile Water

- 1000 mL bottle
- Distilled sterile water



Z#	price
G3919404	<b>\$4.29</b>

## BAXTER Saline Solution

- 1000 mL Bottle
- 0.9% saline solution



Z#	price
G4094054	<b>\$4.40</b>



### PROLINE Chest Waders

- Plain toe
- 300 denier nylon to rubber outsole, midsole, and shank
- 52" overall length
- Dark green

features removable insole and adjustable side strap

#	size	inseam
G3858215	9	33"
G3858206	10	34"
G3858224	11	34"
G3858172	12	35"

each **\$56.30**



### MUSTANG SURVIVAL Ring Buoy with Reflective Tape

- 32 lb buoyancy
- 30" dia
- LDPE
- ■ USCG TYPE IV APPROVED TO SOLAS, CCG AND BV/MED APPROVED

#	price
G1227414	<b>\$78.15</b>



### MUSTANG SURVIVAL Work Vest Life Jacket

- Universal size fits 30"-52" chest
- Belt and buckle closure, side and shoulder adjustments
- Easy-to-clean vinyl exterior
- 17½ lb buoyancy
- Reflective tape, fall protection slot on back

#	price
G4312734	<b>\$46.54</b>



### MUSTANG SURVIVAL Ring Buoy Bag

- Multi-filament polypropylene rope
- 90' rope

#	price
G4213492	<b>\$26.83</b>



### STEARNS Rescue Mate Throw Bag

- Nylon cordura rope
- 70' of 1800 lb tensile strength rescue rope

#	price
G3038725	<b>\$42.27</b>



### STEARNS Flotation Cushion

- 18 lb buoyancy
- 200 denier nylon
- 16¼" w x 2¾" h
- ■ USCG TYPE IV STANDARDS

#	price
G4826062	<b>\$16.49</b>



### SUNX Sunscreen

- SPF 30
- 0.25 oz packs
- 50 pack
- ■ OSHA STANDARDS

#	price
G4500851	<b>\$30.78</b>



### TECHNICHE Cooling Hat

- L/XL
- Quilted cotton outer with HyperKewl fabric liner
- Water repellent nylon inner
- Khaki

#	price
G4767341	<b>\$20.92</b>



### WESTWARD Waterproof Headlamp

- LED, 200 lumens
  - 25 hour battery life
  - ABS construction
  - IP67 water penetration rating
  - Adjustable elastic head strap
- includes (4) AAA batteries

#	price
G0667283	<b>\$39.63</b>



### STEARNS Flotation Vests

- Nylon, with reflective strips
- Zipper closure
- 15½ lb buoyancy
- 20" length
- ■ USCG TYPE III STANDARDS

#	size	fits chest size
G0952707	S	36" to 38"
G3276436	M	40" to 42"
G2974876	L	44" to 46"
G2748015	XL	48" to 50"
G1727451	2XL	50" to 52"
G3385471	3XL	54" to 56"

each **\$66.32**



### MUSTANG SURVIVAL Life Jacket

- Universal size, fits 30"-52" chest
- Buckle closure
- 15½ lb buoyancy
- Nylon construction, with 2 reflective shoulder strips
- ■ USCG TYPE III STANDARDS

#	price
G2818611	<b>\$31.84</b>



### MUSTANG SURVIVAL Inflatable Life Jacket

- Life Jacket
- 420 denier nylon with ANSI reflective tape
- Universal size fits 30"-52" chest
- Belt and buckle closure
- 35 lb buoyancy
- ■ USCG TYPE II/V STANDARDS

#	price
G2479242	<b>\$287.41</b>



### Rearm Kit

#	price
G2887306	<b>\$58.90</b>



### FULTON Life Vest Lights

- Orange body with clear lens
- Requires (1) D battery
- ■ USCG STANDARDS

#	price
G4158926	<b>\$7.60</b>





# SAFETY

## NORTH SAFETY Auto Travel Kit

- 12½" w x 9¾" h
- includes emergency blanket, safety light, flash light, batteries, whistle, ice scraper, emergency candles, box of weatherproof matches, folding shovel, first aid kit, three-piece fleece set, handwarmer, car care guide and bag

Z#	price
G0865751	<b>\$42.83</b>



## FIRST AID ONLY Vehicle First Aid Kit

- Vehicle mount
- 137 components
- Yellow plastic case
- 2½" w x 9" d x 8½" h

Z#	price
G2388461	<b>\$21.71</b>



## VALUE BRAND Back Up Alarm

- 97dB sound level
- Plastic
- Universal mount
- 3½" h x 4" l
- 12 to 24 VDC

Z#	price
G0285144	<b>\$15.35</b>



## CORTINA Safety Flares

- Non spike
- 20 minute duration
- Red flare
- 11½" length
- 72 pack
- ■ UL LISTED

Z#	price
G1954574	<b>\$177.82</b>



## CORTINA Triangle Warning Kit

- Highway rated
- ■ FMVSS, SAE-W4-74DOT STANDARDS
- includes (3) warning triangles and storage box

Z#	price
G2653917	<b>\$20.83</b>



## VALUE BRAND 28" Traffic Cone

- Reflective white collar
- 15" base
- PVC
- ■ NCHRP, MUTCD & ASTM STANDARDS

Z#	price
G3518286	<b>\$16.99</b>



## VALUE BRAND Traffic Cones

- Non-reflective
- Flexible PVC
- ■ NCHRP & MUTCD STANDARDS

Z#	height	base size	price
G3022467	18"	10½"	<b>\$7.99</b>
G1636521	28"	14"	<b>\$12.99</b>



## VALUE BRAND 18" Traffic Cones

- Polyethylene
- Stackable
- 11" base

Z#	color
G1715016	green
G2431511	white
G2133765	yellow
G1302411	red
G0896585	blue

each **\$7.69**



## CORTINA Telescoping Cone Bar

- For use with traffic cones
- PVC
- Extends from 5' to 8'
- includes PVC rings that loop over cone tops

Z#	price
G4013387	<b>\$22.88</b>

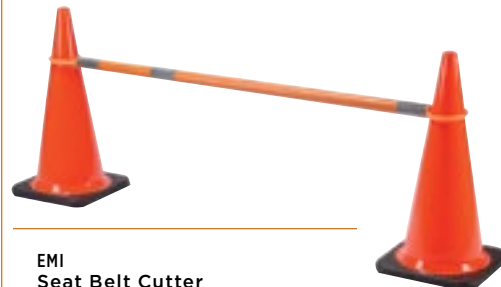

## EMI Seat Belt Cutter

- Plastic with stainless steel blade
- 1¾" w x 4¾" h

Z#	price
G3915326	<b>\$3.44</b>



**VALUE BRAND  
Handheld Warning Flag**

- 18" x 18" vinyl flag
- Includes 24" wood dowel

Z #	price
G1028325	<b>\$2.49</b>



**CONDOR  
Safety Vests**

- Polyester mesh
- 1" reflective stripes
- Elastic side straps
- Machine washable

Z #	size
G0007682	universal
G0007716	XL-3XL

each **\$10.69**



**CONDOR  
Safety Sashes**

- High visibility 1 3/4" reflective tape
- 1 front pocket
- Polyester
- Machine washable
- Snap closure

Z #	size
G0007113	S/M
G0007122	L/XL
G0007131	2XL/3XL

each **\$24.78**



**CORTINA  
Stop/Slow Traffic Paddle**

- ABS plastic
- 9" plastic handle
- 18" x 18" sign

Z #	price
G2476031	<b>\$29.68</b>



**VALUE BRAND  
Speed Bump Sign**

- Aluminum
- 12" w x 1/2" l x 10" h

Z #	price
G5550763	<b>\$21.16</b>



**CORTINA  
EZ Grab Delineator Posts**

- Polyethylene post
- Molded top grab handle for easy movement
- Silver tape
- 45" height
- Moveable, 10 lb rubber base
- ■ NCHRP-350 STANDARDS

Z #	color
G0343664	orange
G2879536	blue
G2199906	white
G2110753	yellow

each **\$33.88**



**CORTINA  
EZ Grab Delineator Post**

- 43" h
- 7" mountable aluminum base
- Orange
- Permanent mount

Z #	price
G2425631	<b>\$22.92</b>



**DIXIE  
Traffic Barrier**

- Polyethylene
- 16" w x 60" l x 24" h
- 33 lb
- Includes reflective strips

Z #	price
G3011811	<b>\$154.09</b>



**RUBBERMAID  
Mobile Safety Barrier**

- Polypropylene
- Quick release safety straps
- 13" w x 13" L x 40" h
- ■ ANSI STANDARDS

Z #	price
G3008397	<b>\$407.25</b>



**CORTINA  
Type 1 and 2 Barricades**

- Type 1**
- Polypropylene with vinyl tape
  - 40" w x 96" l x 40" h
  - Includes (2) A frame legs and (1) I-beam board

Z #	price
G4857273	<b>\$85.00</b>
G4857307	<b>\$106.41</b>



- Type 2**
- Polypropylene and metal with vinyl tape
  - 24" w x 41" l x 41" h
  - ■ NCHRP-350 & MUTCD STANDARDS

Z #	price
G4964303	<b>\$65.22</b>

**VALUE BRAND  
Speed Bump**

- Plastic
- 3 hole design
- 10" w x 48" l x 2" h
- ■ MINIMUM 30% POST-CONSUMER RECYCLED CONTENT
- Includes concrete mounting hardware

Z #	price
G5650102*	<b>\$132.53</b>

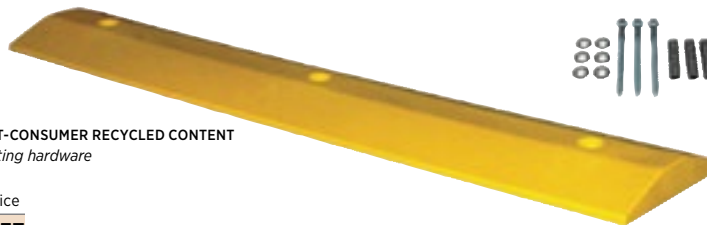



# SAFETY

MORE THAN 800,000 ITEMS ONLINE

### STI Fire Barrier Pillows

- Intumescent material
- ■ UL AND ULA LISTED, FM APPROVED

Z#	dimensions	price
G0549875	4" w x 9" d x 1" h	<b>\$9.68</b>
G0523205	4" w x 9" d x 2" h	<b>\$10.43</b>
G3143402	6" w x 9" d x 2" h	<b>\$13.90</b>
G0719932	6" w x 9" d x 3" h	<b>\$16.51</b>



### VALUE BRAND Fire Blanket

- Gray wool blanket
- 66" w x 80" l blanket

includes red and black trimmed cordura bag

Z#	price
G3891282	<b>\$42.29</b>



### COLD FIRE Fire Retardant Spray

- 32 oz net weight
- 25 sq-ft coverage
- Spray application
- Non-corrosive
- Non-flammable
- Does not stain

Z#	price
G4768522	<b>\$16.97</b>



### JONSECO Fire Extinguisher Cabinet

- 10 lb capacity
- Surface mount
- Indoor/outdoor use
- Plastic
- 8 1/4" w x 9" d x 23 1/2" h

Z#	price
G4334766	<b>\$167.12</b>



### KIDDE Fire Extinguisher Bracket

- 10 lb capacity
- 5 1/4" cylinder diameter
- Steel with metal retention strap

Z#	price
G0804097	<b>\$34.09</b>



### KIDDE Fire Extinguisher Wall Hanger

- 2.5-2.75 lb capacity
- 3 1/2" cylinder diameter
- Steel with metal retention strap

Z#	price
G3496157	<b>\$5.82</b>



### KIDDE Dry Chemical Fire Extinguisher

- 10 lb capacity
- Rechargeable, 17 to 21 second discharge time
- Steel cylinder
- Monoammonium phosphate extinguishing agent
- 20' range max
- 195 psi operating pressure
- ■ OSHA STANDARDS
- ■ UL RATING 4A, 60B:C

Z#	price
G0629562	<b>\$99.37</b>



### KIDDE Dry Chemical Fire Extinguisher

- 2.5 lb capacity
- 8 to 10 second discharge time
- Aluminum cylinder
- Sodium bicarbonate extinguishing agent
- 14' range max
- 100 psi operating pressure
- ■ UL RATING 4A, 10B:C

Z#	price
G4152005	<b>\$18.51</b>



### AMEREX Halotron Fire Extinguisher

- 2.5 lb capacity
- 9 second discharge time
- Steel cylinder
- HydroChloroFluoroCarbon extinguishing agent
- 8' range max
- 100 psi operating pressure
- ■ ANSI, UL, EPA STANDARDS
- ■ UL RATING 4A, 2B:C

Z#	price
G3980146	<b>\$101.40</b>



### AMEREX Wet Chemical Fire Extinguisher

- 12.68 lb capacity
- Rechargeable, 53 second discharge time
- Stainless steel
- Potassium acetate extinguishing agent
- 12' range max
- 100 psi operating pressure
- ■ UL 8/ UL 711 STANDARDS
- ■ UL RATING 4A, 2A:K

Z#	price
G3697687	<b>\$135.23</b>



### KIDDE Emergency Escape Ladder

- 25' length
- For single use with 3-story structures
- Steel
- 1000lb weight capacity
- Tangle-free, window mount

#	price
G1366827	<b>\$58.65</b>



### SAFETY TECHNOLOGY INTERNATIONAL Stopper II Pull Station Cover

- Pull station cover with horn
- 3 1/8" w x 3 1/8" d x 10 1/4" h
- Polycarbonate
- Wall mount
- 95 to 105 dB
- Requires 9V battery
- ■ UL, CUL, ADA, FM, NY TO BSA STANDARDS

#	price
G1595151	<b>\$65.18</b>



### EDWARDS SIGNALING 270 Series Fire Alarm Pull Station

- Single action, tool reset
- Wall mount
- 3 1/8" w x 2 1/2" d x 4 9/16" h

#	price
G3378383	<b>\$21.97</b>



### EDWARDS SIGNALING Fire Alarm Control Panel

- 3-zone alarm
- Steel
- 3.5 A panel, 2A circuit capacity
- 14 1/4" w x 3 3/4" d x 19 1/2" h
- ■ UL LISTED

#	price
G3291416	<b>\$306.60</b>



### SAFETY TECHNOLOGY INTERNATIONAL Rex Plus Electronic Watchdog Alarm

- Plastic
- Detects movement through doors, glass, and walls
- Alerts you to movement with watchdog sounds or tranquil sounds of nature

#	price
G0262945	<b>\$68.89</b>



### CRC Smokeless Aerosol Tester

- Functional test for commercial and residential smoke detectors
- 2.5 oz
- Operating temperature 56° to 120° F
- ■ UL, OSHA, NFPA STANDARDS

#	price
G3127564	<b>\$10.95</b>



### FALCON Mighty Sonic Safety Horn

- 8 oz net weight
- 120dB @ 10 ft sound level
- Plastic horn
- Tetrafluoroethane gas propellant
- Operating temperature -20° to 120° F

Horn	#	price
	G0819612	<b>\$17.63</b>



8 oz Refill Can	#	price
	G1783774	<b>\$13.64</b>

### KIDDE Smoke & Carbon Monoxide Alarm

- 120 VAC operated, 9V battery backup
- Electrochemical, ionization detecting method
- Lighted power and alarm indicator with silence feature
- Screw mount
- ■ UL STANDARDS
- features voice warning, peak level memory and reset button

#	price
G1818765	<b>\$49.99</b>



### BRK Smoke Alarm

- Ionization detection method
- 120 VAC operated, 9V battery backup
- Audible alert 85 dB at 10 ft
- Red LED visual alert
- 5 1/2" diameter
- ■ UL217, CSFM, NFPA72, HUD, FHA STANDARDS

#	price
G1464127	<b>\$9.11</b>



### STI FireStop Pipe Collars

- For plastic pipes
- Up to 3hr fire rating

#	length	price
G0572957	for 2" pipes	<b>\$11.63</b>
G1443486	for 3" pipes	<b>\$15.53</b>
G2583472	for 4" pipes	<b>\$19.11</b>

### 3M Fire Barrier Sealant

- 10.1 oz cartridge
- Up to 4 hr fire rating
- Red-brown color
- Intumescent material
- ■ UL LISTED

#	price
G1799411	<b>\$11.03</b>



### 3M Fire Barrier Duct Wrap

- Vitreous spun fiber
- Up to 2 hr fire rating
- 48" w x 25' l x 1 1/2" h
- ■ UL CLASSIFIED, ASTM E2336 CERTIFIED

#	price
G3435722	<b>\$517.32</b>



### MSA Smoke Tube Kit

- Glass tubes with break-off tips
- For mine shafts and tunnels, commercial buildings and industrial processing plants

includes aspirator bulb,  
(2) rubber plugs,  
(6) smoke tubes  
and carrying case

Kit	#	price
	G3093772	<b>\$121.10</b>

### Plastic Replacement Tubes

- 12 pack
- | #        | price          |
|----------|----------------|
| G2598732 | <b>\$83.87</b> |





# SAFETY

## SENTRY SAFE Security Safes

- Steel
  - 2 adjustable shelves
  - Electronic lock and override key
  - Holds valuables, electronics and documents
- includes bolt down kit and carpeted interior*

### 4 live locking bolts

- 2.3 cu-ft and 105 lb
- 15½" w x 16½" d x 24" h

**Z#** price  
**G3521411 \$269.68**

### 3 live locking bolts

- 4.3 cu-ft and 195 lb
- 21¾" w x 19¾" d x 27¾" h

**Z#** price  
**G3541431 \$472.96**



## SENTRY SAFE Executive Fire Safe

- Steel
  - 3 adjustable shelves
  - Electronic lock and override key
  - 4.7 cu-ft and 217 lb
  - 21¾" w x 19" d x 37¾" h
- includes bolt down kit and carpeted interior*

**Z#** price  
**G4015401 \$637.27**



## SENTRY SAFE Electronic Security Box

- Steel
  - Electronic lock with override key
  - 0.23 cu-ft and 24 lb
  - 12¾" w x 10½" d x 5¾" h
- includes carry handle, low battery light indicator, silver lock cap, quick start sticker and owner's manual*

**Z#** price  
**G1290195 \$28.69**



## SENTRY SAFE Fire-Safe Security Box

- Steel
- Features a lock key for privacy
- 0.2 cu-ft and 11 lb
- 12" w x 10½" d x 6½" h
- **UL CLASSIFIED, ETL VERIFIED ½ HOUR FIRE PROTECTION**

**Z#** price  
**G0525865 \$17.92**



## BRADY Group Lockout Box

- Steel
- 13 locks max
- 9" w x 3½" d x 6" h

**Z#** price  
**G0961703 \$82.73**



## SENTRY SAFE Commercial Fire Safe

- Steel
  - Digital lock with dual key
  - 2 cu-ft and 211 lb
  - 18½" w x 19½" d x 23¾" h
  - **UL CLASSIFIED, ETL VERIFIED, 2 HR FIRE RATING**
- includes hanging file rack, bolt down hardware, locking drawer, door pocket and key rack and (4) AA batteries*

**Z#** price  
**G0811675 \$425.73**



## ATLANTIC METAL Laptop Security Cabinet

- Welded steel
  - Wall-mount
  - 20¾" w x 5¼" d x 19½" h
- includes cushioned pad and adjustable elastic straps*

**Z#** price  
**G1458441 \$156.94**



## PRINZING Lockout Station

- Acrylic
  - Different keyed locks
  - 14" w x 1¾" d x 14" h
  - **OSHA STANDARDS**
- includes (6) multicolor steel padlocks, (1) pocket, (1) 1" steel jaw dia. hasp, (1) 1½" steel jaw dia. hasp and (10) tags, (10) ties*

**Z#** price  
**G1477874 \$132.04**



## PRINZING Electrical/Valve Lockout Station

- Metal
  - 14" w x 6" d x 16" h
  - **OSHA STANDARDS**
- includes (3) red nylon padlocks, (3) yellow nylon padlocks, (1) 1" steel jaw dia. hasp, (1) 1½" steel jaw dia. hasp, (1) 2½ to 5" valve lockout, (1) 1 to 2½" valve lockout, (1) single pole breaker lockout, (2) multi-pole breaker lockouts, (1) large plug lockout, (1) small plug lockout and (10) tags*

**Z#** price  
**G1058057 \$237.57**



## BRADY Portable Lockout Kit

- Red nylon case
  - For electrical lockouts
  - 8" w x 1" d x 6" h
- includes (2) red nylon keyed-alike padlocks, (2) 1" steel jaw dia. hasps, (2) tags and (2) ties*

**Z#** price  
**G3483155 \$73.86**



**VALUE BRAND**  
**Digitally Locked Key Cabinet**

- Galvanized steel
  - Wall mount
  - 64 key capacity
  - Digital lock on the door
  - 13<sup>3</sup>/<sub>16</sub>" w x 5<sup>1</sup>/<sub>16</sub>" d x 14<sup>2</sup>/<sub>16</sub>" h
- features built-in key number plate, key tags, steel latch lock and key hooks

#	price
G4993527	<b>\$295.95</b>



**LUCKY LINE PRODUCTS**  
**Locking Key Cabinet**

- Polypropylene
  - Wall mount
  - 216 key capacity
  - 15" w x 4" d x 19" h
- includes (2) removable panels, key rings, key tags and mounting hardware and features built-in hooks

#	price
G3620364	<b>\$73.78</b>



**VALUE BRAND**  
**Key Control Cabinets**

- Steel cabinet with beige enamel
  - Wall mount
  - Door has full length hinge and comes with a key lock
- includes (2) keys and key tags and features built-in slotted steel key racks, numbered white snap-hook key tags and control tags

#	capacity	dimensions	price
G1787265	30 key	8" w x 2 <sup>1</sup> / <sub>2</sub> " d x 12" h	<b>\$29.99</b>
G2847126	120 key	13" w x 3 <sup>1</sup> / <sub>4</sub> " d x 17" h	<b>\$59.99</b>



**MASTER LOCK**  
**Magnetic Key Case**

- ABS 747 plastic
- Magnet securely attaches and holds to any steel surface
- 2" w x 4<sup>1</sup>/<sub>16</sub>" d x 1<sup>1</sup>/<sub>8</sub>" h

#	price
G3730185	<b>\$2.63</b>



**HPC**  
**Key Duplicator Machines**

- 120 V
  - Accurate cutting
- includes rotary brush



**Bronze Mini Speedex Portable Manual**

- 1.5 A AC
- 11" w x 8" d x 8" h

#	price
G2828016	<b>\$398.12</b>

**Bronze Premier Speedex Manual**

- 3.5 A AC
- 12" w x 14" d x 8" h

#	price
G3094472	<b>\$638.13</b>



**KABA ILCO**  
**Key Blanks**

- Solid brass
- 5 pins

**10-pack**

- Type: Y11
- Lock manufacturer: Yale
- Office furniture/cabinets keyway type

#	price
G1189842	<b>\$5.29</b>



**50-pack**

- Type: 1145
- Lock manufacturer: Schlage
- Commercial/residential keyway type

#	price
G1976283	<b>\$18.13</b>



**BATTALION**  
**Blank Replacement Key Tags**

- Nickel plated snap hook
- White square-slotted key tags
- 50 pack
- 1<sup>1</sup>/<sub>2</sub>" x 1<sup>1</sup>/<sub>2</sub>"

#	price
G1090241	<b>\$22.45</b>



**VALUE BRAND**  
**Numbered Key Tags**

- Nickel plated snap hook
- White square-slotted key tags numbered 1 to 100
- 100 pack
- 1<sup>1</sup>/<sub>2</sub>" x 1<sup>1</sup>/<sub>2</sub>"

#	price
G4671843	<b>\$24.89</b>



**KIDDE**  
**KeySafe Permanent Pushbutton Key Box**

- Metal
  - Surface mount with push button locking
  - 5 key capacity
  - 2<sup>1</sup>/<sub>8</sub>" w x 2<sup>1</sup>/<sub>4</sub>" d x 4<sup>1</sup>/<sub>2</sub>" h
- includes mounting hardware

#	price
G3025041	<b>\$29.60</b>



**ABUS**  
**Surface Mount Lock Box**

- Metal
  - Combination locking
  - 20 key capacity
  - 3<sup>3</sup>/<sub>8</sub>" w x 1<sup>3</sup>/<sub>4</sub>" d x 4<sup>3</sup>/<sub>4</sub>" h
- includes mounting hardware

#	price
G3603783	<b>\$30.08</b>





# SAFETY

## MASTER LOCK Breakaway Shackle Padlock

- Steel
  - Keyed alike
  - 3/8" shackle diameter
  - 1 3/16" shackle height
  - 1 3/4" body width
- includes (2) keys

Z#	price
G3468884	<b>\$4.20</b>



## MASTER LOCK Commercial Padlocks

- Steel
  - Keyed alike
- includes (2) keys

Z#	shackle height	shackle dia	body width	price
G2892915	3/4"	9/32"	1 1/8"	<b>\$6.05</b>
G2756381	1 5/16"	5/16"	1 3/4"	<b>\$6.63</b>
G2280381	2 1/2"	5/16"	1 3/4"	<b>\$7.93</b>



## MASTER LOCK Brass Padlock

- Brass body and hardened steel shackle
  - Keyed alike
  - 1/4" shackle diameter
  - 1 3/16" shackle height
  - 1 1/2" body width
- includes (2) keys

Z#	price
G1937765	<b>\$2.81</b>



## BRADY Lockout Padlocks

- Hardened steel shackle, nylon body material
  - Keyed different
  - 1/4" diameter shackle
  - 1 1/2" shackle height
  - 1 1/2" body width
  - 6 pack
  - ■ OSHA STANDARDS
- includes (1) key and (3) labels

Z#	price
G0062842	<b>\$74.30</b>



## AMERICAN LOCK Lockout Padlocks

- Anodized aluminum body and chrome-plated boron steel shackle
- Keyed different
- 1/4" shackle diameter
- 1 1/2" body width
- ■ OSHA STANDARDS AND UL VALIDATION
- ► MORE OPTIONS ONLINE

### Green

- 1 1/2" shackle height

Z#	price
G0070865	<b>\$9.80</b>



### Red

- 3" shackle height
- includes (2) keys

Z#	price
G0236783	<b>\$9.91</b>



## AMERICAN LOCK Disc Cam Locks

- Keyed alike
  - 3/4" mounting hole diameter
  - 1 5/16" head diameter
- includes removable flat cam and reversible offset cams

### Bright Brass

- 3 1/2" max latching distance
- For 3/8" door thickness

Z#	price
G0100231	<b>\$4.97</b>

### Bright Nickel

- 1 1/2" max latching distance
- For 7/8" door thickness

Z#	price
G0100484	<b>\$5.74</b>



## MASTER LOCK Lockout Padlocks

- Zenex thermoplastic body and hardened steel shackle
  - Keyed different
  - 1/4" shackle diameter
  - 1 1/2" shackle height
  - 1 1/2" body width
  - ■ OSHA STANDARDS, UL VALIDATION
- includes (1) key and write on labels

Z#	color
G0062605	red
G0062614	yellow
G0062562	blue

each **\$7.94**



## BATTALION Mini Cam Lock

- Black powder coating
  - Keyed alike
  - 3 1/8" mounting hole diameter
  - 1 9/32" head diameter
  - For 1 9/16" door thickness
  - 5 3/8" max latching distance
- includes (2) keys, (2) cams and hardware

Z#	price
G2069277	<b>\$4.52</b>



## KABA Mechanical Pushbutton Deadbolts

- Brushed chrome finish, zinc case
- Push button key pad
- Thumb-turn handle
- Weather resistant
- 4" w x 3 3/4" d x 5 1/2" h

Z#	latch length	price
G0000165	1"	<b>\$98.27</b>
G0000201	5/8"	<b>\$118.15</b>





### MASTER LOCK Combination Padlocks

- Brass body, hardened steel shackle
- Resettable
- 4 dials on bottom of lock
- 5/16" shackle diameter
- 2" body width
- For use with job boxes and gang boxes, utility meters, substations and cable boxes, tool chests, tool boxes and tool cribs

Q #	shackle height	price
G0639676	1"	\$12.58
G1795412	2 1/4"	\$14.44



### MASTER LOCK Resettable Combination Padlock

- Die cast body and hardened steel shackle
- 4 dials located on bottom of lock
- 5/16" shackle diameter
- 1" shackle height
- 2" body width
- For use with job boxes and gang boxes, utility meters, substations and cable boxes, tool chests, tool boxes and tool cribs

Q #	price
G0919642	\$8.57



### MASTER LOCK Resettable Combination Lock

- Die cast body and boron carbide shackle
- 4 dials located on bottom of lock
- 3/8" shackle diameter
- 1 1/16" shackle height
- 2 1/4" body width
- For use with utility meters, substations and cable boxes, construction sites and equipment, industrial, storefront and business gates

Q #	price
G3637137	\$8.87



### MASTER LOCK Combination Lock

- Stainless steel body, hardened steel shackle
- 1 dial located on center
- Opens with key number V660 (not included)
- 5/32" shackle diameter
- 3/4" shackle height
- 1 7/8" body width
- For use with school, employee and athletic lockers

Q #	price
G1266632	\$5.89



### MASTER LOCK Side Combination Padlock

- Aluminum body, chrome plated steel shackle
- Resettable
- 4 dials located on side
- 1/4" shackle diameter
- 7/8" shackle height
- 1 1/16" body width

Q #	price
G3735611	\$7.16



### BRADY Single Pole Circuit Breaker Lockouts

- Polypropylene and nylon
- Clamp-on
- 120/277 circuit breaker voltage
- 5/32" max shackle diameter
- 3/4" x 1"
- 6 pack
- OSHA STANDARDS

Q #	price
G1334776	\$53.78

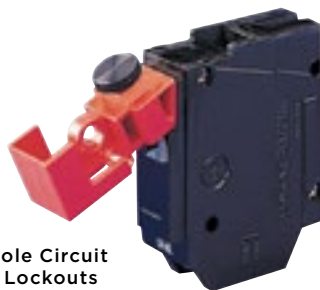

### MASTER LOCK Circuit Breaker Lockouts

- Steel
- Clamp-on
- 120/277 circuit breaker voltage
- 5/32" max shackle diameter
- OSHA STANDARDS

#### Standard Tie Bar Lockout

- 3/4" w x 3" d x 3/4" h

Q #	price
G1042212	\$4.35



### Tall Breaker Toggle Lockout

- 1 1/4" w x 3 1/2" d x 1 1/4" h

Q #	price
G1703204	\$6.43



### KABA Mechanical Push Button Lock

- Mechanical push button lock
- Zinc case material, satin chrome finish
- 1 user code
- Weather resistant, vandal resistant
- 3 hour fire rating
- For 3 1/8" x 7 3/8" OD
- For 1 1/8" to 2 1/4" door thickness

ANSI STANDARDS  
includes thumb or key turn passage set

Q #	price
G1554533	\$257.11



### TRILOGY BY ALARM LOCK Keyless Access Control Lock

- Electronic, keyless lock
- Zinc alloy lock, satin chrome finish
- 100 max user codes
- Timed entry allowance from 5-20 sec
- 3 hour fire rating
- For 3 1/4" x 8" OD
- For 1 3/8" to 1 7/8" door thickness
- GRADE 1, ADA, UL LISTED STANDARDS

includes (5) AA batteries and key override

Q #	price
G2707521	\$471.08



### ESSEX Access Control Keypad

- Stainless steel
- 500 max user codes
- Weather resistant
- 5 VDC, 12 to 24 VDC power required
- Timed entry allowance from 1 to 99 sec
- 3 3/8" w x 7/16" d x 5 1/8" h

features field selectable keypad configuration, tamper alarm, remote bypass (rex), anti-tailgating, manual or timed latching and time zone/restricted access input

Q #	price
G0689421	\$229.94



### BATTALION Fingerprint Door Lock

- Satin chrome finish
- Up to 100 user codes
- Accepts fingerprint, pin or key

includes hardware and (4) AA batteries

Q #	price
G1490221	\$282.82





# SAFETY

## MASTER LOCK Safety Lockout Hasps

- Steel
- Snap-on
- 6 (max) number of padlocks
- 3/8" max shackle diameter

Z#	size	closed hasp	price
G1978794	1 3/4" x 4 1/2"	1"	<b>\$4.44</b>
G3189094	1 3/8" x 5"	1 1/2"	<b>\$5.27</b>



## BRADY Labeled Lockout Hasps

- 5052 Anodized aluminum alloy
- Snap-on
- 6 (max) number of padlocks
- 5/16" max shackle diameter
- 1 1/2" x 1" closed hasp hole size
- 5 pack
- 3" x 7 1/4"

Z#	price
G0357253	<b>\$73.34</b>



## BRADY Adjustable Ball Valve Lockout

- Polypropylene
  - 0° to 175° F range
  - For use with valves and pipes
  - Fits handle size 1" to 2 1/2"
  - Fits pipe size 1/2" to 2 1/2"
  - 4 (max) number of padlocks
  - ■ OSHA STANDARDS
- includes (2) ball valve lockout halves*

Z#	price
G0891423	<b>\$25.53</b>



## MASTER LOCK Hidden Shackle Padlock

- Solid steel body, boron alloy shackle
  - Hidden shackle configuration
  - Keyed alike
  - Opens with key number 410K959
  - 3/8" shackle diameter
- includes (1) lock and (2) keys*

Z#	price
G0422204	<b>\$25.64</b>



## MASTER LOCK Hidden Shackle Padlock Hasp

- Solid steel
- Open shackle configuration
- High security level
- For use with hidden shackle padlocks
- 9" w x 1/4" d x 4 1/2" h

Z#	price
G3202735	<b>\$15.53</b>



## MASTER LOCK Trailer Security Locks

*includes lock guard*

Z#	material	keyed	price
G2139103	chrome plated hardened steel	alike	<b>\$22.64</b>
G2292403	nickel plated zinc die cast	different	<b>\$25.42</b>



## BRADY Plug Lockout

- Thermoplastic
- Fits up to 3" diameter cord and 5 1/2" long plugs
- 1/4" max shackle diameter
- 3" x 5 1/2"

Z#	price
G1581002	<b>\$15.21</b>



## BRADY Plug Lockout

- Polypropylene
- Fits up to 1" diameter cord and 2 1/2" long plugs
- 3/16" max shackle diameter
- 7" x 3 3/4"
- ■ OSHA STANDARDS

Z#	price
G2535976	<b>\$17.66</b>



## MASTER LOCK Ball Valve Lockout

- Steel/aluminum
- 70° to 350° F range
- For use with insulated pipes
- Fits handle and pipe size of 1/4" to 4"
- 1 (max) number of padlocks
- ■ OSHA STANDARDS

Z#	price
G1833194	<b>\$23.14</b>

## ACCUFORM SIGNS Standard Ball Valve Lockout

- Plastic
- 0° to 250° F range
- Designed for locking out quarter-turn ball valves with flat "dog-leg" handles
- Fits all major brand ball valves
- Fits 3/8" to 1 1/4" handle size
- Fits 3/8" to 1 1/4" pipe size
- 1 (max) number of padlocks
- ■ 29 CFR 1910.147 STANDARDS

Z#	price
G3742891	<b>\$15.65</b>



**MOTOROLA  
Talkabout  
Two-Way Radios**

- FRS/GMRS band type
  - 1W output
  - 22 channels, 27 miles range
  - 2 pack
  - 2<sup>1</sup>/<sub>64</sub>" w x 1<sup>1</sup>/<sub>32</sub>" d x 7<sup>1</sup>/<sub>32</sub>" h
  - FCC licence required
- includes (2) MR350R radios, (2) NiMH rechargeable battery packs, (2) belt clips, (1) dual drop-in charger, (1) charger adapter and (1) emergency checklist and features a built in flashlight, 83 digital codes and emergency alert button*



Q #	price
G2383744	<b>\$58.82</b>

**MOTOROLA  
RDX Series Two-Way Radio**

- VHF band type
  - 5W output
  - 146 to 174 MHz frequency
  - 10 channels, 300,000 sq-ft indoor range
  - Programmable channels
  - 84+ programmable digital codes and 39+ programmable analog codes
  - 1<sup>3</sup>/<sub>4</sub>" w x 2<sup>1</sup>/<sub>4</sub>" d x 4<sup>1</sup>/<sub>2</sub>" h
  - **MILITARY STANDARDS**
- includes rechargeable battery, wall charger, removable antenna and belt clip and features repeater capable*



Q #	price
G4449295	<b>\$259.00</b>

**KENWOOD  
Portable Two-Way Radio**

- UHF band type
  - 1.5W
  - 451 to 470 MHz frequency
  - 6 Channels, 225,000 sq-ft inside range
  - 1<sup>1</sup>/<sub>8</sub>" w x 2<sup>1</sup>/<sub>8</sub>" d x 4<sup>1</sup>/<sub>8</sub>" h
  - FCC license required
- includes rechargeable li-ion battery, 2.5-hour fast charger, belt-clip, 2 year warranty and operating instructions and features voice scrambling and programmable channels*



Q #	price
G1566871	<b>\$164.00</b>

**MOTOROLA  
Two-Way Radio**

- ISM band type
  - 1W output
  - 900 MHz frequency
  - 25 channels, 300,000 sq-ft inside range
  - 1<sup>2</sup>/<sub>64</sub>" w x 2<sup>1</sup>/<sub>64</sub>" d x 5<sup>1</sup>/<sub>2</sub>" h
  - **MILITARY STANDARDS**
- includes radio, battery, carry holster, transformer, drop in tray and antenna and features SMS messaging, public-group calling up to 25 groups, programmable channels*



Q #	price
G2263335	<b>\$259.00</b>

**BUSHNELL  
ED Glass Binoculars**

- Fully, multi-coated lenses with XTR technology
  - Waterproof, fog proof, roof prism type
  - Field of view is 314'
  - 10 x 42 magnification
  - 8<sup>1</sup>/<sub>4</sub>" w x 3<sup>7</sup>/<sub>8</sub>" d x 8<sup>1</sup>/<sub>4</sub>" h
- includes neck strap and carrying case*



Q #	price
G4712967	<b>\$667.00</b>

**NORTHWEST  
Long Eye Relief Binoculars**

- Fully coated lenses
  - Fog proof, waterproof, porro prism type
  - Field of view is 305' @ 1000 yd
  - 10 x 50 magnification
  - 7<sup>1</sup>/<sub>4</sub>" w x 7<sup>1</sup>/<sub>8</sub>" d x 2<sup>9</sup>/<sub>16</sub>" h
- includes nylon case and strap, lens cover and cleaning cloth*



Q #	price
G2040026	<b>\$187.87</b>

**KENWOOD  
Compact Speaker Microphone**

- Plastic
- For use with G1566871
- 1" w x 2" d x 2" h



Q #	price
G0971722	<b>\$69.90</b>

**MOTOROLA  
Swivel Earpiece**

- Plastic ear loop
- Contains in-line PTT
- For use with G2263335



Q #	price
G2977834	<b>\$31.93</b>

**MASTER LOCK  
Keyed Cable Locks Kit**

- Steel flexible cables with protective coating
- Keyed alike locks
- 3 pack of (1) red, (1) green and (1) blue cables
- 6' length, 3/16" diameter
- Used for bicycles, ladders, generators, toolboxes and gates



Q #	price
G0865846	<b>\$11.92</b>

**MASTER LOCK  
Combination Cable Lock**

- Braided steel wires with a vinyl finish
- Integrated resettable lock and cable
- 4 dial combination security for keyless convenience
- 5' length, 3/8" diameter
- Used for bicycles, ladders, grills and gates



Q #	price
G0299232	<b>\$12.91</b>

**MASTER LOCK  
Adjustable Cable Lockouts**

- Plastic coated steel cable
- Up to 4 padlocks
- For use with lockout padlocks and safety padlocks
- 3/16" cable diameter
- **OSHA STANDARDS**



Q #	length	price
G1556405	6'	<b>\$17.94</b>
G3164594	15'	<b>\$26.76</b>



**BRADY  
Grip-Cinching  
Cable Lockouts**

- For use with switches, valves and energy devices
- Up to 4 padlocks
- 8' long cable
- **OSHA STANDARDS**



Q #	diameter	cable	price
G1828434	3/16" cable	vinyl coated steel	<b>\$45.28</b>
G2617386	3/8" cable	nylon	<b>\$47.83</b>



# SAFETY

MORE THAN 800,000 ITEMS ONLINE

### ELECTROMARK Keep Out Warning Sign

- Aluminum
- Surface mount

Z#	size	price
G6544526*	14" x 10"	\$63.11

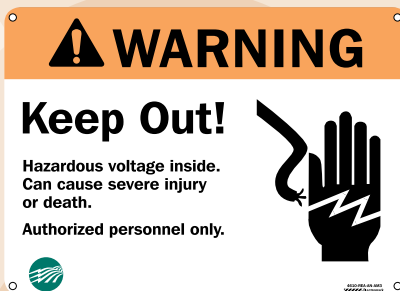

### BRADY Open Door Slowly Sign

- Self-adhesive polyester
- Surface mount
- ■ ISO STANDARDS

Z#	size	price
G0202246	14" x 10"	\$10.68



### BRADY Bilingual Safety Signs

- Plastic
- English & Spanish
- Surface mount
- 10" x 14"
- ■ OSHA, ANSI STANDARDS

Z#	legend
G0199875	lift trucks
G0199857	hearing
G0199866	eye

each **\$11.22**



### BRADY Hearing Protection Sign

- Self-adhesive polyester

Z#	size	price
G5272881	10" x 7"	\$7.62



### ACCUFORM SIGNS Electrical Panel Caution Sign

- Self-adhesive vinyl
- Surface mount

Z#	size	price
G3860963	10" x 7"	\$7.28



### ACCUFORM SIGNS Confined Space Danger Signs

- Surface mount
- 14" x 10"

Z#	material	price
G3860315	self-adhesive vinyl	\$9.63
G3860333	aluminum	\$18.32



### BRADY Eye Protection Sign

- Plastic
- Surface mount
- ■ ISO STANDARDS

Z#	size	price
G0201616	14" x 10"	\$11.22



### VALUE BRAND High Voltage Danger Signs

- Self-adhesive
- Surface mount
- ■ OSHA, ANSI STANDARDS

Z#	size	price
G4481556	10" x 7"	\$4.10
G4481854	5" x 3½"	\$1.23
G4480384	14" x 10"	\$6.99

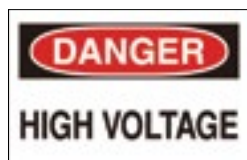

### ACCUFORM SIGNS Fall Protection Sign

- Aluminum
- Surface mount

Z#	size	price
G3863142	10" x 7"	\$12.60



### BRADY Pinch Point Caution Sign

- Self-adhesive polyester
- Surface mount
- ■ OSHA, ANSI STANDARDS

Z#	size	price
G0201302	5" x 3½"	\$2.08



### ELECTROMARK Hazardous Material Signs

- Reflective
- Surface mount
- 10" x 7"

Z#	material	price
G4173723	aluminum	\$36.20
G4196796	self-adhesive polyester	\$34.27



### BRADY Floor Marking Signs

- 17" diameter
- Sections of clear anti-skid material

Z#	legend	material	price
G1435104	fork lift	anti-slip vinyl	\$31.65
G4297833	pedestrian	polyester	\$52.34



## LYLE

## Crosswalk Sign

- Diamond grade aluminum
- FHWA min retro reflectivity
- ■ MUTCD STANDARDS

Q #	size	price
G0228286	12" x 36"	\$69.65



## LYLE

## No Parking Sign

- High intensity prismatic aluminum
- FHWA minimum retro reflectivity
- ■ MUTCD STANDARDS

Q #	size	price
G0212721	12" x 18"	\$21.46



## ACCUFORM SIGNS

## Fire Stairways Sign

- Plastic
- Surface mount

Q #	size	price
G3826304	10" x 7"	\$7.98



## LYLE

## Handicap Parking Sign

- High intensity prismatic aluminum
- Min 70% post-consumer recycled content
- FHWA min retro reflectivity
- ■ MUTCD STANDARDS

Q #	size	price
G0211836	12" x 18"	\$23.66



## DEFLECTO

## Slow-Moving Vehicle Placard

- High impact ABS material
- ■ ASAE STANDARDS

Q #	size	price
G3915037	16" x 14"	\$9.23



## ACCUFORM SIGNS

## Fire Alarm Sign

- Plastic
- Surface mount

Q #	size	price
G3859204	7" x 10"	\$17.20



## LYLE

## Stop Signs

- High intensity prismatic aluminum
- FHWA min retro reflectivity
- ■ MUTCD STANDARDS

Q #	size	price
G0228365	12" x 12"	\$23.09
G0228392	24" x 24"	\$48.04
G0228401	30" x 30"	\$77.51



## BRADY

## Stop Ahead Traffic Sign

- Engineer grade aluminum
- Min 70% post-consumer recycled content
- ■ MUTCD STANDARDS

Q #	size	price
G0180117	24" x 24"	\$33.19



## ZING

## Fire Door Sign

- Recycled self-adhesive polyester
- Min 70% post-industrial recycled content
- Does not contain PVC
- Surface mount

Q #	size	price
G3836323	10" x 7"	\$8.95



## LYLE

## Yield Sign

- High intensity prismatic aluminum
- FHWA min retro reflectivity
- ■ MUTCD STANDARDS

Q #	size	price
G0229354	24" x 24"	\$42.60



## TAPCO

## Sign Posts

- Steel/aluminum
- Green powder coated finish
- U-channel posts
- Prepunched 3/8" mount holes

Q #	length	price
G2493644	6'	\$25.71
G0890206	8'	\$30.54



## BRADY

## Fire Hazard Cabinet Labels

- Self-adhesive polyester

Q #	size	price
G2268183	12" x 3 1/2"	\$6.27
G4213605	24" x 7"	\$14.68



## DICKE

## Portable Sign Stand

- Aluminum

Q #	size	price
G4535027	92" x 57"	\$241.31



## PRINZING

## Fire Extinguisher Signs

- Plastic
- Surface mount

Q #	style	dimensions	price
G0356797	V-shaped	9" wx 4" dx 6" h	\$13.58
G1025263	L-shaped	4 1/2" x 18"	\$17.54

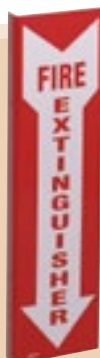



# SAFETY

**NOTICE**  
**SAFETY GLASSES  
 REQUIRED  
 BEYOND THIS POINT**

### BRADY Safety Glasses Signs

- Surface mount
- 14" x 10"
- ■ ISO STANDARDS

Z#	material	price
G0236476	self-adhesive polyester	<b>\$10.68</b>
G0236485	aluminum	<b>\$18.29</b>

### COSCO Restroom Signs

- Braille for ADA compliance
- 6" x 9"

includes pictograms and adhesive mounting pads

Z#	legend	material	price
G2099027	unisex	plastic	<b>\$5.50</b>
G1127183	handicapped	vinyl	<b>\$6.05</b>
G0422712	men and women	plastic	<b>\$11.01</b>

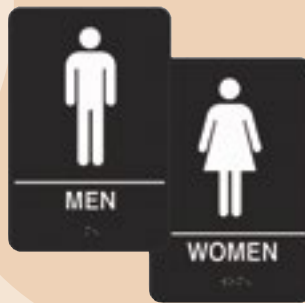

### VALUE BRAND Eye Wash Station Signs

- Plastic
- ■ ANSI, OSHA STANDARDS

Z#	size	price
G4482037	10" x 7"	<b>\$6.02</b>
G4482064	14" x 10"	<b>\$8.39</b>



### ACUITY LITHONIA Quantum LED Exit Sign

- Thermoplastic
- Universal mount
- 120/277 V
- NiCAD battery
- ■ UL, NFPA, NEC AND OSHA STANDARDS

Z#	dimensions	price
G1967043	11 3/4" wx 1 3/8" d x 7 7/8" h	<b>\$37.29</b>



### BRADY No Smoking Signs

- Surface mount

Z#	material	size	price
G0133244	self-adhesive polyester	3 1/2" x 5"	<b>\$2.08</b>
G0133217	self-adhesive polyester	7" x 10"	<b>\$7.62</b>
G0133226	aluminum	7" x 10"	<b>\$11.00</b>

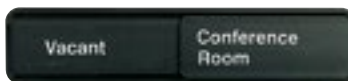

### MMF INDUSTRIES Conference Room Sign

- Plastic
- Sign reads "Vacant" or "In Use" under slide
- Surface mount

Z#	size	price
G4901775	9" x 2"	<b>\$21.36</b>

### BRADY First Aid Sign

- Aluminum
- Surface mount

Z#	size	price
G7586013	14" x 10"	<b>\$16.67</b>



### VALUE BRAND Restricted Area Sign

- Plastic

Z#	size	price
G4482003	14" x 10"	<b>\$8.15</b>



### ACCUFORM SIGNS Severe Weather Shelter Sign

- Projection sign

Z#	size	price
G4993213	8 1/2" x 6"	<b>\$12.74</b>



### UNITED VISUAL PRODUCTS Maintenance Sign

- Plastic
- Surface mount

Z#	size	price
G4017142	9" x 6"	<b>\$15.19</b>



### ZING Security Notice Sign

- Recycled plastic
- Min 70% post-consumer recycled content

Z#	size	price
G3833925	14" x 10"	<b>\$14.48</b>

### ACCUFORM SIGNS Hard Hats Sign

- Plastic
- Surface mount

Z#	size	price
G3791995	10" x 7"	<b>\$7.98</b>



### BRADY Fire Exit Signs

- Glow-in-the-dark aluminum
- 21" x 7"

Z#	legend	price
G1555897	Exit w/running man and arrow pointing left	
G1052274	Exit w/running man and arrow pointing right	
		each <b>\$48.66</b>



**VALUE BRAND Letter & Number Interlocking Stencils**

- Brass
- 92 piece numbers and letters

Q#	character height	price
G1844866	1"	<b>\$40.14</b>
G2496496	2"	<b>\$55.74</b>
G1270753	4"	<b>\$142.36</b>



**VALUE BRAND No Parking Stencil**

- Plastic
- 12" character height

Q#	size	price
G0922652	75" x 18"	<b>\$30.72</b>

**VALUE BRAND Handicapped Parking Stencil**

- Plastic
- 43" character height

Q#	size	price
G0987682	47" x 46"	<b>\$33.93</b>



**VALUE BRAND Arrow Parking Lot Stencil**

- Plastic
- 20" character height

Q#	size	price
G0833061	37" x 21"	<b>\$30.72</b>



**TOUGHSTRIPE Floor Marking Tape**

- Polyester
- Performance temperature 0° to 130° F
- 2" x 100'
- OSHA, ANSI STANDARDS
- MORE COLORS ARE AVAILABLE ONLINE

Q#	color
G4140857	black/yellow
G4177101	red
G3992554	black/white
G4061757	yellow

each **\$52.91**

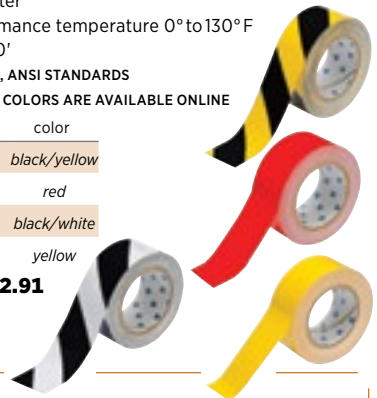

**RAE Bike Lane Pavement Stencil**

- Clear low density polyethylene
- 78" character height

Q#	size	price
G7081295*	44" x 90"	<b>\$260.13</b>



**DESCO Safety Warning Tape**

- Vinyl
- Legend: "Caution Static Sensitive Area"
- ANSI STANDARDS

Q#	size	price
G4073474	3" x 54'	<b>\$24.96</b>



**BRADY Footprints Floor Tape**

- Vinyl skid-resistant tape with removable adhesive
- 3 3/4" x 1 1/8"
- 10 pack includes (5) left and (5) right footprints

Q#	color
G1224483	blue

each **\$73.97**



**MASTER MAGNETICS Magnetic Strip Tape**

- Indoor/outdoor adhesive on nonmagnetic side
- Dry mixture of ferrite powder and rubber polymer resin
- 13 lb max pull

Q#	size	price
G3903584	1" x 50'	<b>\$18.67</b>



**TOUGHSTRIPE L Shaped Floor Marking Tape**

- Polyester tape
- 20 pack
- ANSI, OSHA STANDARDS

Q#	size	price
G4297632	2" x 5"	<b>\$30.38</b>



**SAFETY GLASSES**

**INCOM MANUFACTURING Safety Glasses Warning Tape**

- Adhesive-backed laminate PVC tape
- Slip resistant
- Complies with UL 410-COF for floor graphics

Q#	size	price
G1871685	3" x 54'	<b>\$25.07</b>

**3M PREFERRED CONVERTER Reflective Marking Tape**

- Vinyl
- White
- 150' length
- ASTM STANDARDS

Q#	width	price
G4294911	1"	<b>\$40.09</b>
G4229811	2"	<b>\$80.18</b>
G4316636	3"	<b>\$120.25</b>
G4312901	4"	<b>\$160.34</b>



**BRADY Blank Label Tape Cartridges**

- Vinyl film
- Indoor/outdoor
- For use with Brady Handimark
- 2" x 50'
- MORE COLORS ARE AVAILABLE ONLINE

Q#	color
G0156931	white
G0156947	yellow
G0157017	clear
G0156983	orange

each **\$93.41**



**BRADY Pipe Marking Arrow Tape**

- Vinyl
- Green/white
- 90' length
- ASME STANDARDS

Q#	width	markers per card	price
G0109356	2"	720	<b>\$48.40</b>
G0109261	1"	1440	<b>\$24.23</b>





# SAFETY

## BRADY

### Caution Tags

- Economy polyester
- 25 pack
- Reverse side legend: "Do Not Remove This Tag To Do So Without Authority Will Mean Immediate Discharge. It Is Here For A Purpose."

• ■ OSHA, ANSI STANDARDS  
includes (25) nylon fasteners

Z#	size	price
G0349894	3" x 5 3/4"	\$36.55



## BRADY

### GlobalMark2 Multicolor Industrial Label Printer

- Desktop label printer with touch screen
  - 1/2" to 4" max tape width
  - Thermal transfer print technology
- includes GlobalMark2 multicolor industrial printer, 5 year Brady360 warranty, keyboard, power cord, cleaning kit, usb cable and Brady file management utility

Z#	price
G1677663	\$2,775.27

## BRADY

### Danger Tags

- Laminated polyester
- 2 sided tags
- Withstands pull force up to 80 lbs
- 25 pack

includes (25) nylon fasteners

Z#	size	price
G0412027	3" x 5 1/2"	\$60.97



## BRADY

### Chemical Labels

- Polyester
- 100 pack

Z#	size	price
G4187976	6" x 6"	\$32.93

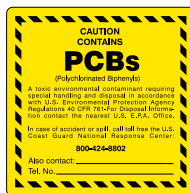

## BRADY

### Arc Flash Protection Labels

- Self-adhesive polyester
- 5 pack
- Current NEC labeling requirements

Z#	size	price
G3407835	5" x 3 1/2"	\$10.79

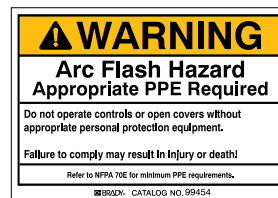

## BADGER TAG & LABEL CORP

### Gas Cylinder Tags

- 100 pack of yellow paper tags with wires attached
- One sided, two perforations

Z#	size	price
G3914723	3 1/4" x 6 1/4"	\$11.30



## BADGER TAG & LABEL CORP

### NFR Self-Laminating Labels

- Pressure sensitive white paper label with permanent adhesive, clear polyester self-laminate
- 500 pack

Z#	size	price
G3984075	2 7/8" x 1 1/8"	\$33.86



## ELECTROMARK

### Padlock Labels

- Self-adhesive vinyl
- 25 pack

Z#	size	price
G4187793	5" x 3/4"	\$14.04



## VALUE BRAND

### Out of Service Tags

- Cardstock material
  - 100 pack
  - ■ ISO STANDARDS
- includes (100) 12" cotton strings

Z#	size	price
G1012846	3" x 5 3/4"	\$39.33



## VALUE BRAND

### Blank Brass Tags

- 100 pack of round brass tags

Z#	diameter	price
G1436127	1"	\$14.46
G1112754	1 1/4"	\$23.35
G0386522	1 1/2"	\$32.64



## VALUE BRAND

### Numbered Brass Tags

- 25 round brass number tags
- 1 1/2" diameter

Z#	numbers
G1380285	1 through 25
G2667131	26 through 50

each \$21.58



## STRANCO INC

### Quality Inspection Labels

- Self-adhesive polyester
- 350 pack

Z#	size	price
G4840805	1" x 1 1/2"	\$19.75



## ROLL PRODUCTS

### Tamper Resistant Security Labels

- Clear litho material
- 250 pack

Z#	size	price
G4331302	3/4" x 2 1/2"	\$10.76





**BRADY**  
Bad Planning Sign

- Plastic
- Surface mount

Item #	size	price
G6065586	10" x 7"	\$7.80

**BAD PLANNING ON  
YOUR PART DOES  
NOT NECESSARILY  
CONSTITUTE AN  
AUTOMATIC EMERGENCY  
ON MY PART**

**BRADY**  
Beware of Owner Sign

- Engineer grade aluminum
- Surface mount

Item #	size	price
G4901093*	12" x 18"	\$37.25



**BRADY**  
Notice Novelty Sign

- Plastic
- Surface mount

Item #	size	price
G6104944	10" x 7"	\$6.83

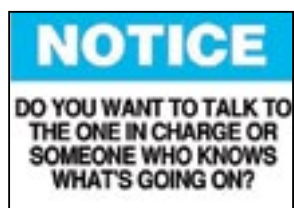

**BRADY**  
OSHA Caution Sign

- Plastic
- Surface mount

Item #	size	price
G6070863	10" x 7"	\$7.82

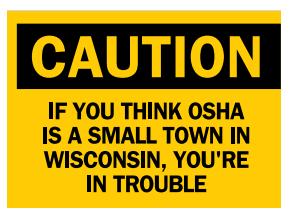

**BRADY**  
Cheese to go with that Whine Sign

- Plastic
- Surface mount

Item #	size	price
G7467765	10" x 7"	\$7.86



**BRADY**  
Nobody Notices Novelty Sign

- Plastic
- Surface mount

Item #	size	price
G6108602	10" x 7"	\$6.83

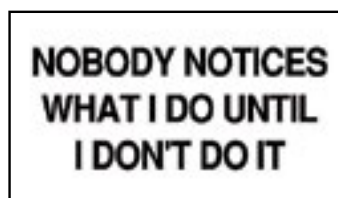

**ACCUFORM SIGNS**  
Be Careful Sign

- Plastic
- Surface mount

Item #	size	price
G3812751*	14" x 10"	\$11.80



**BRADY**  
Think Like I do Sign

- Plastic
- Surface mount

Item #	size	price
G6215334	10" x 7"	\$6.84



**ACCUFORM SIGNS**  
Your Mother Doesn't Work Here Sign

- Aluminum
- Surface mount

Item #	size	price
G3942811	14" x 10"	\$18.72

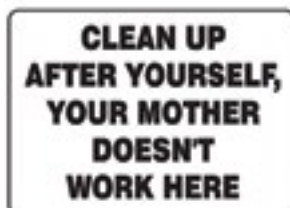

**BRADY**  
Fishing and Hunting Stories Sign

- Plastic
- Surface mount

Item #	size	price
G6148563	10" x 7"	\$7.82



**BRADY**  
Complaint Department Sign

- Plastic
- Surface mount

Item #	size	price
G6103587	10" x 7"	\$6.83



# PLUMBING



<p><b>VALVES</b></p> <p>pg <b>43</b></p>	<p><b>FITTINGS</b></p> <p>pg <b>44</b></p>
<p><b>TUBING AND PIPES</b></p> <p>pg <b>46</b></p>	<p><b>CLAMPS AND HANGERS</b></p> <p>pg <b>47</b></p>
<p><b>ADHESIVES AND SEALANTS</b></p> <p>pg <b>48</b></p>	<p><b>PIPE TOOLS</b></p> <p>pg <b>51</b></p>
<p><b>PUMPS AND ACCESSORIES</b></p> <p>pg <b>52</b></p>	<p><b>TOILETS</b></p> <p>pg <b>58</b></p>
<p><b>WASTE DISPOSALS</b></p> <p>pg <b>66</b></p>	<p><b>WATER HEATERS</b></p> <p>pg <b>68</b></p>

## TOP BRANDS





**APOLLO**

**Brass Ball Valves**

- 2-piece, in-line valves
- FNPT x FNPT connection
- 600 psi WOG max
- ■ MSS STANDARDS
- ► MORE SIZES ONLINE

#	size	price
G0363596	½"	<b>\$8.80</b>
G2717251	¾"	<b>\$9.69</b>
G0928541	1"	<b>\$19.72</b>
G0854515	1¼"	<b>\$21.54</b>
G2759041	1½"	<b>\$29.09</b>
G1092131	2"	<b>\$43.10</b>



**APOLLO**

**Bronze Ball Valves**

- 2-piece, in-line valves
- FNPT x FNPT connections
- 600 psi WOG max
- 0° to 400° F
- ■ MSS STANDARDS
- ► MORE SIZES ONLINE

#	size	price
G0269577	½"	<b>\$17.21</b>
G3045384	¾"	<b>\$26.37</b>
G0493394	1"	<b>\$31.85</b>
G0905414	1¼"	<b>\$68.57</b>
G2637162	1½"	<b>\$77.60</b>
G3124834	2"	<b>\$96.35</b>



**SHARKBITE**

**Push-Fit Brass Ball Valves**

- Use with copper, CPVC and PEX
- 1-piece
- EDPM seals
- 200 psi WOG
- 0° to 200° F
- ■ ASSE, CUPC, IAPMO, IPC, UPC, NSF STANDARDS
- ● CERTIFIED FOR USE IN POTABLE WATER

#	size	price
G4614102	½"	<b>\$11.51</b>
G4546123	¾"	<b>\$13.78</b>



**VALUE BRAND**

**Brass Ball Valves**

- 2-piece
- FNPT x FNPT connections
- 600 psi WOG max
- 0 to 400° F
- ■ MSS STANDARDS

#	size	price
G3367305	¼"	<b>\$3.59</b>
G2275716	⅜"	<b>\$3.59</b>
G0668787	½"	<b>\$4.59</b>
G2829836	¾"	<b>\$6.59</b>
G3364286	1"	<b>\$9.99</b>
G1636555	1¼"	<b>\$17.99</b>
G3163946	1½"	<b>\$19.99</b>
G2187236	2"	<b>\$38.99</b>



**MILWAUKEE VALVE**

**Bronze Gate Valves**

- Use for water, steam and compressed air
- FNPT connection
- 300 psi steam max
- 600 psi water max
- 550° F fluid max
- ■ MSS STANDARDS
- ► MORE SIZES ONLINE

#	size	price
G2276653	½"	<b>\$78.21</b>
G0718182	¾"	<b>\$87.22</b>
G0714113	1"	<b>\$121.68</b>
G2174557	1¼"	<b>\$160.75</b>
G1458563	1½"	<b>\$267.51</b>



**KB**

**Schedule 80 PVC Gate Valves**

- Commercial grade PVC
- Positive shut off
- Nonrising stem
- FNPT connection
- 140° F max
- ● CERTIFIED FOR USE IN POTABLE WATER

#	size	price
G0697794	½"	<b>\$5.59</b>
G0423701	¾"	<b>\$7.69</b>
G3265866	1"	<b>\$10.98</b>
G1967515	1¼"	<b>\$17.98</b>
G1774726	1½"	<b>\$14.04</b>
G0268554	2"	<b>\$21.69</b>



**HAYWARD**

**PVC Ball Valves**

- Use with schedule 40/80 pipe and fittings
- Full port
- Blow-out proof stem
- 150 psi WOG max
- 35° to 140° F max

#	size	price
G0700393	1"	<b>\$4.59</b>
G2762864	1½"	<b>\$4.99</b>
G0426727	2"	<b>\$5.19</b>



**KBI**

**Schedule 40 PVC Gate Valves**

- Commercial grade
- Positive shut off
- Nonrising stems
- FNPT connection
- 140° F max
- ● CERTIFIED FOR USE IN POTABLE WATER

#	size	price
G1230196	½"	<b>\$5.58</b>
G1729804	¾"	<b>\$9.86</b>
G3414555	1"	<b>\$7.44</b>
G2464016	1¼"	<b>\$10.32</b>
G1507414	1½"	<b>\$17.44</b>
G2270667	2"	<b>\$19.99</b>

**eZTIPS**  
technical resources

eZTips about valves are available online at [zoro.com/eztips](http://zoro.com/eztips)



# PLUMBING

### VALUE BRAND Fittings

- Class 150 black malleable iron
- For low pressure plumbing
- NPT connection
- 300 psi WOG @ 150° F
- ■ ASTM A-197, ASTM A47, ASME B16.3 AND B16.4, UL LISTED

### Hex Bushings

Item #	size	price
G1785201	3/4" x 3/8"	<b>\$0.59</b>
G2612994	3/8" x 1/4"	<b>\$0.59</b>
G0998496	1/2" x 1/4"	<b>\$0.59</b>
G2275533	1/2" x 3/8"	<b>\$0.59</b>
G2635963	3/4" x 1/2"	<b>\$0.69</b>
G0705196	1" x 3/4"	<b>\$0.99</b>



### Tees

Item #	size	price
G1751723	3/4"	<b>\$0.99</b>
G2141221	3/8"	<b>\$1.00</b>
G0500683	1/2"	<b>\$0.99</b>
G0634776	3/4"	<b>\$1.19</b>
G1495191	1"	<b>\$1.89</b>



### Unions

Item #	size	price
G2791923	3/4"	<b>\$3.09</b>
G1182781	3/8"	<b>\$3.04</b>
G1543875	1/2"	<b>\$2.89</b>
G3114194	3/4"	<b>\$3.79</b>
G0914593	1"	<b>\$5.39</b>

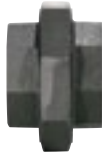

### 45° Elbows

Item #	size	price
G3054572	3/4"	<b>\$0.92</b>
G3338851	3/8"	<b>\$0.92</b>
G1939384	1/2"	<b>\$0.71</b>
G3080795	3/4"	<b>\$1.06</b>
G2202837	1"	<b>\$1.56</b>



### 90° Elbows

Item #	size	price
G1379445	3/4"	<b>\$0.89</b>
G0733381	3/8"	<b>\$0.89</b>
G1060647	1/2"	<b>\$1.19</b>
G2789351	3/4"	<b>\$0.99</b>
G3194791	1"	<b>\$1.59</b>



### Caps

Item #	size	price
G2358151	3/4"	<b>\$0.58</b>
G0655505	3/8"	<b>\$0.58</b>
G1268574	1/2"	<b>\$0.55</b>
G0670546	3/4"	<b>\$0.55</b>
G2428106	1"	<b>\$0.95</b>



### Floor Flanges

Item #	size	price
G2740166	3/4"	<b>\$1.99</b>
G0633753	3/8"	<b>\$1.99</b>
G1596061	1/2"	<b>\$2.09</b>
G1218567	3/4"	<b>\$2.89</b>
G1529762	1"	<b>\$3.19</b>



### VALUE BRAND Pipe Nipples

- Black welded steel
- Schedule 40
- WOG (PSI) 300 @ 150° F
- Saturated steam pressure 150 psi
- ■ ASTM-A-53 TYPE E OR F, ASTM A-733, WVN 351 STANDARDS

### 3/8" Pipe Size

Item #	length	price
G0756481	close	<b>\$0.34</b>
G3047527	2"	<b>\$0.45</b>
G2183501	4"	<b>\$0.66</b>
G3421713	6"	<b>\$0.87</b>
G0566176	8"	<b>\$1.06</b>
G2916532	10"	<b>\$1.27</b>
G0997771	12"	<b>\$1.45</b>



### 1/2" Pipe Size

Item #	length	price
G1230625	close	<b>\$0.39</b>
G2047071	2"	<b>\$0.49</b>
G0941735	4"	<b>\$0.68</b>
G2937033	6"	<b>\$0.92</b>
G2387752	8"	<b>\$1.16</b>
G2128987	10"	<b>\$1.37</b>
G2005561	12"	<b>\$1.59</b>



### 3/4" Pipe Size

Item #	length	price
G3119277	close	<b>\$0.45</b>
G2292071	2"	<b>\$0.86</b>
G0992923	4"	<b>\$0.82</b>
G2177427	6"	<b>\$1.14</b>
G0837173	8"	<b>\$1.45</b>
G0933091	10"	<b>\$1.75</b>
G1565103	12"	<b>\$2.04</b>



### ANDERSON Fittings

- Chrome-plated brass
- FNPT connection
- 125 psi max
- Class 125
- ■ ANSI B 16.24, ANSI B 16.15 STANDARDS

### Caps

Item #	size	price
G2137432	3/4"	<b>\$10.21</b>
G2589307	3/8"	<b>\$10.21</b>
G2334132	3/4"	<b>\$17.91</b>
G1648683	1"	<b>\$25.35</b>



### Couplings

Item #	size	price
G3197756	3/4"	<b>\$12.97</b>
G1950751	3/8"	<b>\$16.28</b>
G1237652	3/4"	<b>\$22.61</b>
G2960614	1"	<b>\$34.02</b>



### 90° Elbows

Item #	size	price
G3117362	3/4"	<b>\$16.28</b>
G3160683	3/8"	<b>\$17.68</b>
G0767042	3/4"	<b>\$27.85</b>
G2953474	1"	<b>\$42.60</b>



### Tees

Item #	size	price
G2198244	3/4"	<b>\$22.55</b>
G0604606	3/8"	<b>\$22.55</b>
G3310106	1/2"	<b>\$24.87</b>
G0727273	3/4"	<b>\$30.43</b>



### NIBCO Wrot Copper Fittings

- C x C connection
- Close rough
- Temperature range -20° to 400° F
- ■ ASME/ANSI B16.22 STANDARDS



### 90° Elbows

Item #	size	OD	max pressure	price
G0962236	1/2"	3/8"	722 psi @ 100° F	<b>\$0.58</b>
G1252623	3/4"	1/2"	582 psi @ 100° F	<b>\$1.08</b>
G2895313	1"	1 1/8"	494 psi @ 100° F	<b>\$2.74</b>
G2309377	1 1/4"	1 3/8"	439 psi @ 100° F	<b>\$4.44</b>
G0364305	1 1/2"	1 3/4"	408 psi @ 100° F	<b>\$9.59</b>
G0266271	2"	2 1/2"	364 psi @ 100° F	<b>\$16.07</b>

### Couplings

Item #	size	OD	max pressure	price
G0341257	1/2"	3/8"	722 psi @ 100° F	<b>\$0.40</b>
G0275143	3/4"	1/2"	582 psi @ 100° F	<b>\$0.77</b>
G0302897	1"	1 1/8"	494 psi @ 100° F	<b>\$0.91</b>
G3263592	1 1/4"	1 3/8"	439 psi @ 100° F	<b>\$2.95</b>
G0723861	1 1/2"	1 3/4"	408 psi @ 100° F	<b>\$4.02</b>
G2473292	2"	2 1/2"	364 psi @ 100° F	<b>\$5.95</b>

### Reducers

Item #	size	max pressure	price
G0481801	1/2" x 3/4"	722 psi @ 100° F	<b>\$0.87</b>
G0682735	1/2" x 3/8"	722 psi @ 100° F	<b>\$0.71</b>
G0824101	3/4" x 1/2"	582 psi @ 100° F	<b>\$1.49</b>
G2596501	3/4" x 3/8"	582 psi @ 100° F	<b>\$2.41</b>
G2708501	1" x 3/2"	494 psi @ 100° F	<b>\$2.73</b>
G0243257	1" x 3/4"	494 psi @ 100° F	<b>\$2.49</b>

## e7TIPS

### PIPE SIZE SELECTION GUIDE

Knowing the pipe size you are working with can be confusing. Many people assume that the "pipe size" refers to the outside diameter of the pipe. It doesn't. "Pipe size" refers to what is considered the nominal diameter. The easiest way to know what nominal pipe size you are working with is to use a conversion chart. For male threads, measure the outside diameter of the pipe or pipe fitting and use the chart to identify the corresponding nominal diameter a.k.a "pipe size". For female threads, measure the inner diameter to find the "pipe size".

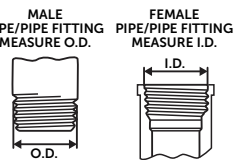

NOTE: "Pipe" and "tubing" are not measured the same way. Tubing is measured and named based on the actual outside diameter of the tube.

pipe size	OD (male) or ID (female)	decimal equivalent
3/8"	3/8"	0.313"
1/2"	13/32"	0.405"
3/4"	25/32"	0.540"
1"	1 1/8"	1.125"
1 1/4"	1 1/4"	1.315"
1 1/2"	1 5/8"	1.625"
2"	2 1/8"	2.125"
2 1/2"	2 3/8"	2.625"
3"	3 1/8"	3.125"
3 1/2"	4"	4.000"
4"	4 1/2"	4.500"

**VALUE BRAND Stainless Steel Fittings**

- FNPT connection
- 300 psi max
- 150 psi steam max
- ■ MATERIAL CONFORMS TO ASTM-A-351, THREADS CONFORM TO ANSME B1.20.1, MEETS MSS-SP-114 CLASS 150 PRESSURE RATINGS

**90° Elbows**

② #	size	price
G0933003	1"	<b>\$8.95</b>
G1628006	2"	<b>\$26.53</b>
G0522076	3"	<b>\$57.92</b>



**Tees**

② #	size	price
G3441033	1"	<b>\$12.36</b>
G1701655	2"	<b>\$38.34</b>
G2205357	3"	<b>\$81.40</b>



**Flanges**

② #	size	price
G0850157	1"	<b>\$27.86</b>
G2791031	2"	<b>\$55.93</b>
G2449352	3"	<b>\$104.69</b>



**Couplings**

② #	size	price
G2031811	1"	<b>\$6.28</b>
G2327613	2"	<b>\$21.27</b>
G2745136	3"	<b>\$54.71</b>



**GF PIPING SYSTEMS PVC Fittings**

- Schedule 80
- Socket x Socket connection
- 140° F max
- ■ ASTM D1784, NSF14 CERTIFIED

**90° Elbows**

② #	size	price
G2068166	1"	<b>\$1.51</b>
G2709996	2"	<b>\$2.88</b>
G2301065	3"	<b>\$7.58</b>
G3197442	4"	<b>\$11.55</b>



**45° Elbows**

② #	size	price
G1312491	1"	<b>\$3.17</b>
G1604845	2"	<b>\$6.84</b>
G1058477	3"	<b>\$17.40</b>
G3255226	4"	<b>\$31.35</b>



**Tees**

② #	size	price
G2991572	1"	<b>\$2.70</b>
G1036542	2"	<b>\$10.30</b>
G5404612	3"	<b>\$19.09</b>
G1765784	4"	<b>\$13.07</b>



**Couplings**

② #	size	price
G2082753	1"	<b>\$1.84</b>
G1866627	2"	<b>\$3.25</b>
G3392986	3"	<b>\$10.14</b>
G1953375	4"	<b>\$12.71</b>



**Y Check Valves**

② #	size	price
G0882357	1"	<b>\$59.90</b>
G0606566	2"	<b>\$134.96</b>
G1402502	3"	<b>\$387.94</b>



**PARKER Compression Fittings**

- Brass
- 65° to 250° F

**Sleeves**

② #	tube size	75 psi to	price
G1317407	3/8"	400	<b>\$2.37</b>
G2842052	1/4"	300	<b>\$2.34</b>
G2978333	3/8"	200	<b>\$2.40</b>



**Male Connectors**

② #	tube size	75 psi to	price
G0760015	3/8"	400	<b>\$8.48</b>
G0974784	1/4"	300	<b>\$12.11</b>
G2641737	3/8"	200	<b>\$12.11</b>



**90° Male Elbows**

② #	tube size	75 psi to	pack	price
G1243322	3/8"	400	25	<b>\$75.68</b>
G1345732	1/4"	300	10	<b>\$18.17</b>
G2240822	3/8"	200	25	<b>\$93.51</b>



**VALUE BRAND Galvanized Malleable Iron Fittings**

- FNPT connection
- 300 psi @ 150° F WOG
- Class 150
- ■ ASTM A-197, ASTM A47, ASME B16.3 AND B16.4, UL LISTED, FM APPROVED, NSF-61 AND AB1953 LISTED

**Floor Flanges**

② #	size	price
G1212364	1/2"	<b>\$2.94</b>
G3164061	3/4"	<b>\$4.02</b>
G1791377	1"	<b>\$4.66</b>
G2542775	2"	<b>\$9.37</b>



**90° Elbows**

② #	size	price
G1820822	1/2"	<b>\$1.08</b>
G1601607	3/4"	<b>\$1.48</b>
G3254517	1"	<b>\$2.23</b>
G0310895	2"	<b>\$6.73</b>



**Tees**

② #	size	price
G1805781	1/2"	<b>\$1.35</b>
G1371447	3/4"	<b>\$1.92</b>
G0346543	1"	<b>\$2.94</b>
G1356801	2"	<b>\$8.39</b>



**Caps**

② #	size	price
G2136163	1/2"	<b>\$0.84</b>
G1723897	3/4"	<b>\$1.01</b>
G1170757	1"	<b>\$1.38</b>
G1108825	2"	<b>\$3.65</b>



**Crosses**

② #	size	price
G2828104	1/2"	<b>\$2.87</b>
G2333371	3/4"	<b>\$3.95</b>
G0635293	1"	<b>\$5.34</b>
G1058075	2"	<b>\$15.02</b>



**VALUE BRAND PVC Couplings**

- Compression connection
- Schedule 40
- 140° F max
- ■ ASTM D1784 STANDARDS

② #	size	price
G1993862	3/4"	<b>\$3.47</b>
G1911612	1"	<b>\$4.58</b>
G2101653	1 1/2"	<b>\$7.25</b>
G3084173	2"	<b>\$13.79</b>



**ZURN PEX PEX Fittings**

- Connects copper, PEX, and CPVC in any combination without the use of soldering, unions, or glue
- EDPM gaskets
- 0° to 200° F
- 200 psi
- ■ STANDARDS: IAPMO, UPC, IPC, CPUC LISTED, ANSI/NSF-61, IGC 1881

**Tees**

② #	size	price
G3746111	1/2"	<b>\$2.72</b>
G3744702	3/4"	<b>\$5.64</b>
G3746942	1"	<b>\$8.81</b>
G3689445	1 1/4"	<b>\$28.69</b>



**Couplings**

② #	size	price
G3746994	1/2"	<b>\$1.48</b>
G3745131	3/4"	<b>\$2.05</b>
G3746671	1"	<b>\$4.20</b>
G3656755	1 1/4"	<b>\$9.53</b>



**Elbows**

② #	size	price
G3745043	1/2"	<b>\$2.28</b>
G3747082	3/4"	<b>\$3.04</b>
G3747484	1"	<b>\$6.94</b>
G3610031	1 1/4"	<b>\$18.03</b>



**SHARKBITE Push to Connect Fittings**

- Connects copper, PEX, and CPVC in any combination without soldering, unions, or glue
- EDPM gaskets
- 0° to 200° F
- 200 psi
- ■ IAPMO, UPC, IPC, CPUC LISTED, ANSI/NSF-61, IGC 188 STANDARDS

**Tees**

② #	size	price
G4551145	3/4"	<b>\$11.07</b>
G4603103	1/2"	<b>\$12.82</b>
G4524021	3/4"	<b>\$13.23</b>
G4579802	1"	<b>\$26.05</b>



**Couplings**

② #	size	price
G4558732	3/4"	<b>\$4.40</b>
G4630087	1/2"	<b>\$5.37</b>
G4636134	3/4"	<b>\$6.59</b>
G4590302	1"	<b>\$18.48</b>



**Elbows**

② #	size	price
G4624663	3/4"	<b>\$9.14</b>
G4621407	1/2"	<b>\$9.28</b>
G4523653	3/4"	<b>\$9.73</b>
G4574552	1"	<b>\$18.48</b>



**LASCO PVC Snap On Saddle Taps**

- Schedule 40
- 140° F max
- ■ ASTM D1784 STANDARDS

② #	size	price
G1255405	3/4"	<b>\$2.11</b>
G1383383	3/4" x 1/2"	<b>\$1.30</b>
G1138654	1" x 1/2"	<b>\$2.57</b>
G1950846	1" x 3/4"	<b>\$3.23</b>





# PLUMBING

MORE THAN 800,000 ITEMS ONLINE

### ZURN PEX Tubing

- Polyethylene
- 100 psi max
- 33° to 180° temperature range
- ■ ASTM F876 F877 STANDARDS

#### PEX Size 1/2"

Z#	length	price
G3744806	100'	<b>\$24.39</b>
G3747362	300'	<b>\$120.40</b>
G3745533	500'	<b>\$200.69</b>

#### PEX Size 3/4"

Z#	length	price
G3745183	100'	<b>\$41.96</b>
G3745244	300'	<b>\$134.14</b>
G3746714	500'	<b>\$329.86</b>



### ZURN PEX Crimp Tool

- Hardened steel
- ■ ASTM F877 ASTM F1807 COMPLIANCE
- includes crimp gauge*

Z#	size
G3746075	3/2"
G3745427	3/4"

each **\$157.25**



### ZURN PEX Quick Clamp Tool

- Hardened steel construction
- ■ ASTM F877 ASTM F1807 COMPLIANCE
- includes crimp gauge and pouch*

Z#	size	price
G3683924	medium	<b>\$163.47</b>



### HARVEL Schedule 40 PVC Pipe

- 10' length
- Max temperature 140°F
- ■ ASTM D1784 & NSF-14 STANDARDS

Z#	size	price
G2952205	1/2"	<b>\$4.35</b>
G3356297	3/4"	<b>\$4.90</b>
G1563667	1"	<b>\$7.52</b>
G1742824	1 1/4"	<b>\$8.59</b>
G0365163	1 1/2"	<b>\$11.38</b>
G2271927	2"	<b>\$14.77</b>

### VALUE BRAND Aluminum Tubing

- 3/8" OD
- -112° to 300° F temperature range
- 390 psi max
- ■ ASTM B210 & WW-T-700/2 STANDARDS

Z#	length	price
G0865487	3'	<b>\$3.99</b>
G1588255	6'	<b>\$7.13</b>

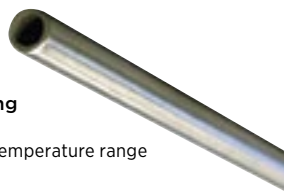

### MUELLER INDUSTRIES Type L Copper Tubing

- 1/4" pipe size
- 912 psi max
- 100° to 400° F
- ■ ASTM B88, B306, B280, & B819 STANDARDS

Z#	length	price
G0539463	20'	<b>\$24.92</b>
G2881654	60'	<b>\$73.31</b>



### GF PIPING SYSTEMS Schedule 80 PVC Pipe

- 10' length
- Max temperature 140°F
- ■ CONFORMS TO REQUIREMENTS OF ASTM D.1784

Z#	size	price
G3330442	1/2"	<b>\$4.84</b>
G3378444	3/4"	<b>\$8.17</b>
G0264616	1"	<b>\$9.36</b>
G1939804	1 1/4"	<b>\$13.22</b>
G3131493	1 1/2"	<b>\$19.17</b>
G2615812	2"	<b>\$19.83</b>

### KURIYAMA Flexible PVC Tubing

- For food and beverage
- 25° to 150° F
- 100' length
- ■ FDA APPROVED CFR TITLE 21 PARTS 170 TO 199

Z#	ID	OD	price
G1679571	3/4"	3/8"	<b>\$16.66</b>
G1727774	3/8"	1/2"	<b>\$24.48</b>



### MUELLER INDUSTRIES Copper Tubing

- For air conditioning and refrigeration
- 100° to 400° F
- 50' length
- ■ ASTM SPECIFICATION B280

Z#	size	price
G0793116	3/4"	<b>\$37.39</b>
G1880532	3/8"	<b>\$58.46</b>



### GF PIPING SYSTEMS CPVC Pipe

- 10' length (coiled)
- Max temperature 210° F
- ■ CONFORMS TO REQUIREMENTS OF ASTM D.1784

Z#	size	price
G3007024	1/2"	<b>\$12.95</b>
G1558207	3/4"	<b>\$17.81</b>
G1062844	1"	<b>\$28.19</b>
G3399523	1 1/4"	<b>\$35.98</b>
G0732602	1 1/2"	<b>\$43.77</b>
G1737181	2"	<b>\$54.75</b>

### MUELLER INDUSTRIES ABS Pipe

- 10' length
- -40° to 180° F
- ■ ASTM F628

Z#	size	price
G1811993	1 1/2"	<b>\$9.17</b>
G1558541	2"	<b>\$13.54</b>
G0527037	3"	<b>\$23.36</b>
G2342697	4"	<b>\$48.96</b>



### ATP Polyethylene Tubing

- 100' length
- 125 psi max
- -50° to 140° F
- 3/8" OD
- ■ FDA STANDARDS

Z#	color
G2267824	natural
G3363516	black
G3210243	blue
G1643031	red
G2286304	yellow

each **\$20.40**





**ANVIL Riser Clamps**

- Carbon steel construction
- ■ A-A-1192A (TYPE 8), WW-H-171-E (TYPE 8), ANSI/MSS SP-69, AND MSS SP-58 (TYPE 8). UL, ULC LISTED

Q #	pipe	max load	length	price
G3352386	2"	300 lb	10¾"	<b>\$3.30</b>
G2118216	3"	500 lb	11¾"	<b>\$3.89</b>
G1509977	6"	1600 lb	14¾"	<b>\$8.36</b>
G336995	8"	2500 lb	18½"	<b>\$13.82</b>



**ANVIL C-Type Wide Mouth Beam Clamp**

- ¾" rod size
- Max load at top 500 lbs
- Max load at bottom 250 lbs
- 1¾" length
- includes set screw and locknut

Q #	price
G1997326	<b>\$1.89</b>



**CADDY Beam Clamp**

- ¾" rod size
- Max load at top 500 lbs
- Max load at bottom 250 lbs
- ¾" length
- ■ FEDERAL SPECIFICATION WW-H-171 (TYPE 23), ANSI/MSS-SP-58 (TYPE 19 & 23) STANDARDS

Q #	price
G1358314	<b>\$0.99</b>



**CADDY Multiflange Beam Clamp**

- ¾" rod size
- Max load C and Z purlins 200lb and flat flanges 160 lb
- 3¼" long
- ■ UL LISTED FOR FIRE PROTECTION APPLICATIONS (MAX 3 IN SCHEDULE 40 STEEL PIPE)

Q #	price
G2363462	<b>\$4.40</b>



**ANVIL Beam Clamps**

- ¾" bolt
- Max load 1000 lbs
- Carbon steel
- ■ A-A-1192A (TYPE 21), WW-H-171-E (TYPE 21), ANSI/MSS SP-69, AND MSS SP-58 (TYPE 21). UL LISTED WHEN USED WITH ¾" AND ½" ROD

Q #	width	price
G3266925	4"	<b>\$7.99</b>
G1262563	5"	<b>\$8.98</b>
G2667113	6"	<b>\$9.33</b>
G0679971	7"	<b>\$10.23</b>
G1277631	8"	<b>\$11.47</b>



**CADDY Rod Hanger Plates**

- Ceiling or wall mount
- 2" pipe size
- Max load 180 lbs
- 1½" length

Q #	material	price
G1251083	malleable iron	<b>\$1.57</b>
G2554167	electro-galvanized malleable iron	<b>\$1.97</b>
G2204745	copper plated malleable iron	<b>\$3.85</b>

**SMITH-BLAIR Pipe Repair Clamps**

- For steel pipes
- Stainless steel construction
- Nitrile gasket
- Carbon steel bolt
- ■ NSF 61 STANDARDS

Q #	size	price
G0343445	¾"	<b>\$11.77</b>
G1526777	1½"	<b>\$14.09</b>
G2326161	2"	<b>\$14.22</b>
G3072894	3"	<b>\$21.37</b>
G2356182	4"	<b>\$21.42</b>
G2058497	6"	<b>\$30.96</b>
G2111767	8"	<b>\$37.43</b>



**SMITH-BLAIR Full Circle Pipe Repair Clamps**

- Stainless steel
- Nitrile gasket
- -20° to 180° F
- ■ NSF 61 STANDARDS

Q #	size	price
G2839986	2"	<b>\$89.93</b>
G0931043	3"	<b>\$109.50</b>
G1675073	4"	<b>\$117.36</b>
G1068593	6"	<b>\$135.86</b>



**DMC Perforated Hanging Strap**

- ¾" x 100'
- ¾"-¾" hole diameter
- 24 gauge

Q #	material	price
G1759685	galvanized steel	<b>\$12.19</b>
G0923991	304 stainless steel	<b>\$61.98</b>

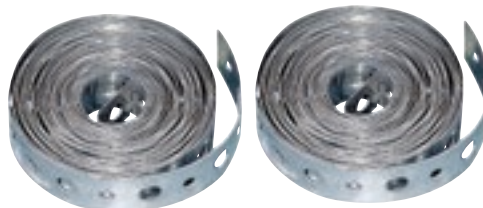

**CADDY Split Ring Hangers**

- ¾" rod size
- 50 lb max load
- ■ FEDERAL SPECIFICATION WW-H-171 (TYPE 25), MANUFACTURERS STANDARDIZATION SOCIETY (MSS) SP-58 AND SP-69 (TYPE 12)

**Cast Iron**

Q #	size	price
G2959792	½"	<b>\$1.31</b>
G3117283	¾"	<b>\$1.39</b>
G2895645	1"	<b>\$1.49</b>
G0577437	1¼"	<b>\$1.79</b>
G1541504	1½"	<b>\$2.59</b>
G1697351	2"	<b>\$2.99</b>



**Electro-Galvanized Iron**

Q #	size	price
G3182252	½"	<b>\$1.73</b>
G0517605	¾"	<b>\$1.77</b>
G2729221	1"	<b>\$1.79</b>
G0415265	1¼"	<b>\$2.43</b>
G1313243	1½"	<b>\$2.99</b>
G1831803	2"	<b>\$3.85</b>



**Copper Electro-Plated Iron**

Q #	size	price
G2475094	½"	<b>\$1.19</b>
G1185107	¾"	<b>\$1.49</b>
G1986117	1"	<b>\$1.59</b>
G0523092	1¼"	<b>\$1.97</b>
G1894295	1½"	<b>\$2.30</b>
G1990326	2"	<b>\$2.86</b>



**CADDY Cushioned Pipe Clamps**

- Recommended for suspension of stationary non-insulated pipe lines
- Max load 180 lb
- Electro-galvanized steel
- Bolt size ¾-16
- ■ MANUFACTURERS STANDARDIZATION SOCIETY (MSS) SP-58 AND SP-69 (TYPE 12)

Q #	pipe size	tube size	price
G2496961	¾"	½"	<b>\$1.17</b>
G2006891	1"	¾"	<b>\$1.41</b>
G1355961	1¼"	1"	<b>\$1.82</b>
G0342142	1½"	1¼"	<b>\$1.87</b>



**CADDY Superklip Tube and Pipe Clamps**

- Non-metallic
- UV resistant

Q #	tube size	price
G2467272	½"	<b>\$0.71</b>
G3479752	¾"	<b>\$0.94</b>
G0476226	1"	<b>\$1.56</b>
G3478133	1¼"	<b>\$1.69</b>
G0270033	1½"	<b>\$2.07</b>





# PLUMBING

MORE THAN 800,000 ITEMS ONLINE



See more tapes on page 277

### ANTI-SEIZE PTFE Thread Sealant Tape

- Density 0.7 to 0.8sg
- 0 to 2000 psi rating
- -400° to 550° F

Z#	size	price
G0426176	½" x 260"	<b>\$1.42</b>
G1610655	½" x 520"	<b>\$1.49</b>



### ANTI-SEIZE PTFE Gas Line Sealant Tape

- Density 1.2 to 1.5 sg
- 0 to 2250 psi gas
- -400° to 550° F
- 0 to 10,000 psi liquid

Z#	size	price
G3399347	½" x 260"	<b>\$2.39</b>
G1243557	½" x 520"	<b>\$5.19</b>



### EZ WELD PVC/CPVC Primer

- Purple
- ■ NSF AND IAPMO LISTED, ASTM F656

Z#	size	price
G1112011	8 oz	<b>\$5.50</b>
G0904127	16 oz	<b>\$10.14</b>
G1743594	32 oz	<b>\$15.42</b>



### EZ WELD PVC Cement

- For PVC pipe and fittings up to 4"
- Clear
- ■ NSF AND IAPMO LISTED, ASTM D2564 STANDARDS

Z#	size	price
G3430655	8 oz	<b>\$4.84</b>
G2486425	16 oz	<b>\$9.94</b>
G2131227	32 oz	<b>\$11.01</b>



### EZ WELD ABS Low VOC Cement

- ABS pipe up to 6"
- ■ NSF AND IAPMO LISTED, ASTM D2235

Z#	size	price
G1581343	8 oz	<b>\$4.62</b>
G3449923	16 oz	<b>\$7.78</b>
G1728772	32 oz	<b>\$11.88</b>



### EZ WELD Pipe Cleaner

- For PVC, CPVC, and ABS pipe and fittings
- Clear

Z#	size	price
G2261892	8 oz	<b>\$4.06</b>
G0664763	16 oz	<b>\$6.15</b>
G3395463	32 oz	<b>\$7.81</b>



### EZ WELD Primer

- For PVC and CPVC pipe and fittings
- Clear
- ■ NSF AND UPC LISTED, ASTM F656

Z#	size	price
G0907821	8 oz	<b>\$3.45</b>
G1762616	16 oz	<b>\$5.45</b>
G2841596	32 oz	<b>\$9.51</b>



### EZ WELD Heavy Duty Cement

- For schedule 40 and 80 PVC pipe and fittings
- Gray
- ■ NSF AND IAPMO LISTED, ASTM D2564

Z#	size	price
G0399147	8 oz	<b>\$4.84</b>
G2087757	16 oz	<b>\$7.95</b>
G0968362	32 oz	<b>\$14.32</b>



### PERMATEX Pipe Thread Sealant

- Used for air conditioning, temperature sending and hydraulic fittings
- Performance temperature range -65° to 300° F
- Flash point 74° F
- PTFE chemical type
- 16 oz

Z#	price
G2819065	<b>\$11.07</b>

### RECTORSEAL Pipe Thread Sealant

- Use with galvanized steel, iron, brass, copper, aluminum, stainless steel, polyethylene, reinforced fiberglass, and PVC pipes
- -50° to 400° F
- 2,600 psi gas
- 12,000 psi liquid
- ■ STANDARDS: TT-S-1732

Z#	price
G0877414	<b>\$8.76</b>



### PERMATEX Pipe Joint Compound

- Universal sealant that lubricates and seals threaded joints on water, oil and fuel lines
- -65° to 400° F
- 16 oz

Z#	price
G1623693	<b>\$6.53</b>



### J-B WELD Wet/Dry Epoxy Adhesive

- Waterproof, petro, chemical, and acid resistant
- 1000 psi shear strength
- Up to 300° F
- 30 minute functional cure
- 2 oz stick

Z#	price
G1150642	<b>\$3.50</b>





**FLUSHMATE**  
**Cartridge Removal Wrench**  
 • For use with Flushmate cartridges

Q #	price
G4316541	<b>\$8.43</b>



**SLOAN**  
**Super Wrench**  
 • For use with Sloan flushometers

Q #	price
G2281946	<b>\$31.48</b>



**VALUE BRAND**  
**Adjustable Hydrant Wrench**  
 • Fits 1½" to 3" nut  
 • Iron construction  
 • 16¾" length

Q #	price
G1148944	<b>\$23.34</b>



**RIDGID**  
**Internal Pipe Wrench**  
 • Jaws expand by eccentric action and are reversible for various sizes  
 • Holds closet spuds, bath, basin and sink strainers through 2" used to install or extract 1" to 2" nipples  
 • 1" to 2" capacity

Q #	price
G2608137	<b>\$90.79</b>

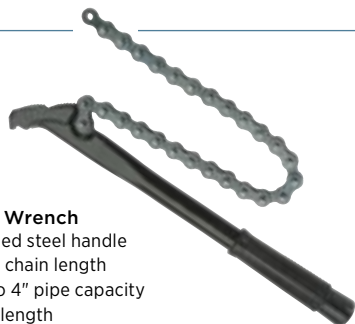

**PROTO**  
**Chain Wrench**  
 • Forged steel handle  
 • 16½" chain length  
 • ¾" to 4" pipe capacity  
 • 16½" length

Q #	price
G3503482	<b>\$29.90</b>



**RIDGID**  
**Straight Pipe Wrench**  
 • Cast Iron handle  
 • Forged steel jaw  
 • ■ MEETS/EXCEEDS FEDERAL SPECIFICATION GGG-N651E, TYPE II, CLASS A

Q #	handle	jaw capacity	price
G3454997	14"	2"	<b>\$28.25</b>
G1625312	18"	2½"	<b>\$46.48</b>
G1386393	24"	3"	<b>\$66.03</b>



**RIDGID**  
**Straight Pipe Wrench**  
 • Aluminum handle  
 • Forged steel jaw  
 • ■ MEETS/EXCEEDS FEDERAL SPECIFICATION GGG-N651E, TYPE II, CLASS A

Q #	handle	jaw capacity	price
G2415901	14"	2"	<b>\$59.50</b>
G1458816	18"	2½"	<b>\$67.13</b>



**PROTO**  
**Straight Pipe Wrench**  
 • Forged steel handle  
 • Forged steel jaw  
 • I-beam handle  
 • 24" length  
 • ■ MEETS/EXCEEDS FEDERAL SPECIFICATION GGG-W-00651D

Q #	price
G2521671	<b>\$61.99</b>



**WESTWARD**  
**Offset Hex Pipe Wrench**  
 • Cast Iron handle  
 • Forged steel jaw  
 • 2½" jaw capacity  
 • 9½" length

Q #	price
G2409933	<b>\$12.63</b>



**RIDGID**  
**Straight Pipe Wrench**  
 • Aluminum handle  
 • Forged steel jaw  
 • 3" jaw capacity  
 • 24" length  
 • ■ MEETS/EXCEEDS FEDERAL SPECIFICATION GGG-N651E, TYPE II, CLASS A

Q #	price
G3015801	<b>\$119.99</b>



**WESTWARD**  
**Straight Pipe Wrench Set**  
 • Aluminum handle  
 • Hardened alloy steel jaw  
 • Spring loaded  
 • 1½" and 2" jaw capacity  
 • 10" l and 14" l

Q #	price
G2473606	<b>\$27.40</b>



**FACOM**  
**Monkey Wrenches**  
 • Hardened steel handle and jaw  
 • 2⅞" jaw capacity

Q #	length	price
G4822632	11½"	<b>\$25.58</b>
G4822867	14½"	<b>\$36.37</b>



**KLEIN TOOLS**  
**Strap Wrenches**  
 • Steel handles  
 • Urethane straps  
 • 34" strap length  
 • 1¾" strap width  
 • 18" handle

Q #	capacity	strap	handle	price
G1790196	1½" - 8"	34"	18"	<b>\$89.31</b>
G3639474	1½" - 5"	23"	12"	<b>\$25.16</b>



# PLUMBING



**DAWN Snip Tube Cutter**

- Cuts plastic, rubber, PVC
- Up to 1" cutting capacity
- High carbon PTFE coated blade
- 8½" length

Z#	item	price
G2323081	cutter	<b>\$17.92</b>
G2998983	replacement blade	<b>\$9.98</b>



**RIDGID Tube Cutter**

- Grooved rollers for close-to-flare cuts, fold-away reamer
- Cuts copper, aluminum, brass
- Zinc alloy body
- ½" to 1½" cutting capacity
- 4¾" length

Z#	item	price
G0862242	cutter	<b>\$28.93</b>
G2012656	aluminum/copper blade	<b>\$8.72</b>
G1772346	steel/stainless steel blade	<b>\$10.00</b>



**RIDGID Close Quarters Tubing Cutter**

- Ratcheting cutting action
- Tube capacity ¼" to 1½"
- Cuts copper, brass, and aluminum tubing
- 8" length

Z#	price
G2859516	<b>\$27.93</b>



**IMPERIAL Compact Tubing Cutter**

- Cuts copper, aluminum, brass, steel, stainless steel
- ½" to ¾" capacity
- 1¾" length
- Enclosed feed

Z#	price
G0782871	<b>\$10.01</b>



**RIDGID Stainless Steel Tubing Cutter**

- Aluminum construction
- Machined steel blade
- ¼" to 1½" cutting capacity
- 6¼" length

Z#	item	pack	price
G2163506	cutter	1	<b>\$53.18</b>
G3358756	replacement blades	2	<b>\$16.28</b>



**RIDGID Bench Yoke Vise**

- Secures ½" to 2" pipe
- Iron yoke and base
- Steel alloy jaws
- Pipe rest and bender

Z#	price
G2858511	<b>\$154.01</b>



**IMPERIAL Tubing Bender**

- Calibrated markings for left, right And offset bends
- Bend angle 90° to 180°
- Center line bend radius of 1¼" for ¼" OD, 1½" for ¾" OD, 1½" for ½" OD
- For tubing ¼", ½", ¾", 1" OD

Z#	price
G1468336	<b>\$48.47</b>



**VALUED BRAND 4-Way Water Key**

- Steel construction
- For ¼", ½", ¾", 1" and 1½" square stems

*includes vinyl pouch*

Z#	price
G0768521	<b>\$3.69</b>



**SUPERIOR TOOL Compression Sleeve Puller**

- Screws directly into compression nut
- Steel construction
- For ½" pipe

Z#	price
G0953994	<b>\$12.45</b>

**RIDGID Pipe Extractor Set**

- Indicates what drill size to use
- Steel construction
- ¼", ½", ¾", 1" extractors



Z#	price
G0466882	<b>\$70.25</b>



**GRIP-ON Chain Pipe Cutter**

- Cuts copper, aluminium, stainless steel, PVC
- 15 alloy steel cutting wheels
- Cutting capacity up to 4½"
- 12" length

Z#	price
G0329165	<b>\$110.73</b>



**ROTHENBERGER Manual Ratchet Threader Kit**

- Capacity 1/2" to 1"
  - Steel pipe cutter 1 1/4"
  - Water pump pliers 10"
  - Heavy duty pipe wrench 14"
- includes 1 3/4" ratchet, quick change die heads 1/2", 3/4", 1"*

#	price
G0314702	<b>\$329.24</b>



**RIDGID Copper Cutting/Prep Machine**

- Capacity tube and fitting 1/2" to 2"
- Built-in 1/2" incremental measuring scale
- (6) fitting brushes 1/2", 3/4", 1", 1 1/4", 1 1/2" and 2" included
- 115 V
- CSA APPROVED AND APPROVED TO UL STANDARD, NRTL

#	price
G1308386	<b>\$1,773.33</b>



**ROTHENBERGER Portable Pipe Threading Machine**

- Pipe capacity 1/2" to 2", bolt 1/4" to 1 1/2"
- 1 HP non-reversing
- 17" x 21"
- 115 V
- CSA APPROVED AND APPROVED TO UL STANDARD

#	price
G0477303	<b>\$2,077.35</b>



**RIDGID Flaring and Cutting Set**

- For 45°, single & double lap flares
- For soft copper, brass, aluminum and mild steel (JIC and bundy) tubing
- Single lap flares 3/16", 1/4", 5/16", 3/8", 7/16", 1/2", 5/8"
- Double lap flares 3/16", 1/4", 5/16", 3/8", 1/2"; cuts 1/8" to 1 1/8"

*includes spare cutter wheel in handle and plastic box*

#	price
G2491194	<b>\$125.58</b>

**RIDGID Roller Head Pipe Stand**

- Pipe capacity 1/8" to 12"
- 32" to 55" adjustable height
- 1000 lb capacity
- Collar and set screw handle for height adjustments

#	price
G3066052	<b>\$108.34</b>



**SUMNER V-Head Pipe Stand**

- Pipe capacity 24"
- 49" height
- 2500 lb load capacity
- 22 1/4" max leg spread
- Folds and has convenient carrying handle
- Fold-A-Jack with V-head

#	price
G4415512	<b>\$80.34</b>



**RIDGID Portable Chain Vise**

- Pipe capacity 1/8" to 6"
- 48" high, hardened steel jaws and tubular legs
- 51 1/2" max leg spread
- Rear pipe support, 3 pipe benders, integrated ground lug

#	price
G4087386	<b>\$546.92</b>



**RIDGID Power Drive Threading Machine**

- Pipe capacity 1/8" to 2", rod 1/4" to 1"
- Double throw reversible
- Die heads and adapters lock in securely
- 115 V
- CSA APPROVED AND APPROVED TO UL STANDARD, NRTL

#	price
G2565455	<b>\$1,665.15</b>





**FRANKLIN**  
**Multistage Booster Pumps**

- Pressure boosting, water transfer, turf irrigation, residential Lawn sprinkler systems, wash down applications, commercial water features, fountains, cisterns, reverse osmosis, aeration
- Use with non-flammable liquids compatible with pump component materials
- 1¼" x 1" FNPT inlet/outlet
- 304 stainless steel housing & impeller
- 208-230/460V

Z#	HP	gpm @ Head	max pressure	price
G5635375*	½	15-40 @ 95-38	48 psi	<b>\$1,028.38</b>
G5602432*	¾	8-25 @ 90-30	43 psi	<b>\$1,208.35</b>



**BELL & GOSSETT**  
**100 Series Hot Water Circulator Pump**

- 3 piece oil-lubricated booster
- 225° F max
- Best efficiency 17 gpm @ 6 ft
- 125 psi max
- 115V ½ HP

Z#	price
G0282931	<b>\$276.96</b>

**BELL & GOSSETT**  
**Seal Bearing Assembly**

- For G0282931
- includes impeller

Z#	price
G3222186	<b>\$71.89</b>



**DAYTON**

**Multistage Booster Pumps**

- Used for pressure boosting, pressure cleaning, spray or mist systems, reverse osmosis, water circulation
- Use with non-flammable liquids compatible with pump component materials
- Cast iron with stainless steel housings
- Permanently lubricated
- Continuous duty
- 115 to 230V
- ■ CSA, CUS LISTED



Z#	HP	inlet/outlet	dimensions	price
G2743124	¾	¾" fnpt	6½" w x 25½" l x 9" h	<b>\$473.93</b>
G1881381	1	¾" fnpt	6½" w x 28¾" l x 9½" h	<b>\$527.05</b>

**TACO**

**Hot Water Circulator Pumps**

- 115V In-Line wet rotor closed loop pumps
- Cast iron housings
- Ceramic shafts with polypropylene impellers
- 230° F max
- ¾" inlet/outlet
- 125 psi max pressure
- ■ UL, CUS STANDARDS



Z#	HP	best efficiency	shut off	size	price
G0376327	½s	9 gpm @ 9 ft	16'	4¾" x 6"	<b>\$98.85</b>
G2753676	¾	6 gpm @ 20 ft	32'	4¾" x 7"	<b>\$187.70</b>

**BELL & GOSSETT**

**NBF Series Hot Water Circulator Pump**

- Maintenance free wet rotor
- 225° F max
- Best efficiency 5 gpm @ 4.8 ft
- Shut off 15'
- 115V, ½s HP



Z#	price
G1353256	<b>\$202.85</b>

**BELL & GOSSETT**  
**Circulating Pump Coupler**

- For G0282931
- Cast iron
- Counter clockwise rotation
- ½" x ½" shaft size

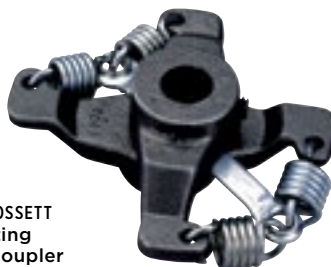

Z#	price
G1559512	<b>\$11.18</b>

**GOULDS WATER TECHNOLOGY**  
**Multi Stage Constant Pressure Booster Systems**

- 1 HP single phase
- Rotary mechanical carbon/silicon carbide seals
- Stainless steel shafts
- 1¼" inlet, 1" outlet
- 2 gal tank capacity



Z#	voltage	pressure	diffuser	price
G1991026	115V	15 to 80 psi	lexan	<b>\$958.52</b>
G3047502	208/230V	20 to 80 psi	stainless	<b>\$1,246.75</b>

**TACO**  
**24 Hour Timer Assembly**

- Works with all Taco circulating pumps
- 1 phase
- 16A



Z#	price
G2719866	<b>\$72.85</b>



**ASCO  
Steam and Hot  
Water Solenoid Valves**

- 2-way/2-position valve design
- Normally closed valve configuration
- Watertight no junction box coil enclosure
- Brass body
- 1/2" conduit w/18" leads

Item #	max psi operating	pipe size & orifice	ambient temp	price
G3101296	50	3/4"	125 °F	<b>\$160.75</b>
G1782514	50	1/2"	125 °F	<b>\$148.56</b>
G2615557	125	3/4"	140 °F	<b>\$271.62</b>
G0679935	125	1/2"	140 °F	<b>\$184.74</b>



**RED HAT  
Brass Air, Oil and  
Water Solenoid Valves**

- Car wash, air compressors, pumps, laundry equipment, industrial water control applications
- For air, inert gas, light oil and water
- Normally closed 2-way, 2-position
- IP rating 66
- 1/2" conduit w/18" leads

Item #	pipe size	orifice dia	price
G1676692	1/2"	5/8"	<b>\$94.53</b>
G3484074	3/4"	3/4"	<b>\$129.99</b>



**HUDSON VALVE  
Self Contained Float Valves**

- Constructed of glass filled nylon
- 1/2" FNPT
- 0° to 90° F temperature range

**0° to 90° F Temperature Range**

Item #	FNPT	psi max	gpm	price
G3381357	1/2"	8 to 65	5 to 30	<b>\$26.57</b>
G1138051	1"	100 psi	10 to 90	<b>\$28.95</b>

**0° to 150° F Temperature Range**

Item #	FNPT	psi max	gpm	price
G3381357	1/2"	100	5 to 30	<b>\$26.57</b>
G1138051	1"	100	10 to 90	<b>\$28.95</b>

**MADISON  
Liquid Level Switch**

- 1/8" NPT
- Polypropylene stem and float
- Selectable switch
- 100 psi max
- SPST contact



Item #	price
G2923024	<b>\$7.93</b>

**WATTS  
Dual Check Valve**

- Bronze body
- FNPT connection
- 3/4" x 4 1/16"
- ASSE 1012, CSA B64.3 CERTIFIED



Item #	price
G0291645	<b>\$44.09</b>

**WATTS  
Pressure Regulator**

- HG560G series
- Brass body
- 3/4" inlet/outlet
- FGHT x MGHT connection
- 300 psi max



Item #	price
G4743882	<b>\$94.15</b>

**SEAMETRICS  
Inline Flowmeter**

- Cast bronze housing
- 3/4" MNPT connection
- .22 to 22 gpm
- 1.5% accuracy
- 150 psi max



Item #	price
G3464011	<b>\$166.50</b>

**ZOELLER  
Full Flow  
Check Valves**

- PVC construction
- Slip x slip connection
- 4.3 psi max water pressure
- Vertical or horizontal mount



Item #	fits	price
G3150472	2" pipe	<b>\$32.40</b>
G0359283	1 1/4" or 1 1/2" pipe	<b>\$12.60</b>

**FRANKLIN  
Submersible  
Motor and Pump  
Control Boxes**

- Pole or wall mount
- 3R enclosure
- 1 phase 230V
- Up to #10 AWG wire
- 4 13/16" w x 2 13/16" d x 8 7/16" h
- CSIR control box



Item #	motor/pump	amperage	price
G2198445	1/2 hp	6 A	<b>\$44.06</b>
G1099332	3/4 hp	8 A	<b>\$48.40</b>
G1803103	1 hp	9.8 A	<b>\$52.93</b>

**FRANKLIN  
Submersible  
Motor and Pump  
Control Boxes**

- Pole or wall mount
- 3R enclosure
- 1 phase 230V
- Up to #2 AWG wire
- 8" w x 5 13/16" d x 9 5/16" h
- CSCR control box



Item #	motor/pump	amperage	price
G2095536	2 hp	13.2 A	<b>\$128.75</b>
G2413862	3 hp	17 A	<b>\$148.70</b>
G2489654	5 hp	27.5 A	<b>\$228.65</b>



**DAYTON**  
**Deep Well**  
**Submersible Pumps**

- 303 Stainless steel
- 3 wire
- 1½ HP
- 230V
- Control box required



Z#	gpm	price
G1133492	10	<b>\$927.94</b>
G0640132	20	<b>\$827.93</b>

**LITTLE GIANT**  
**MD-SC Series Magnetic Drive Pumps**

- For mild chemicals at moderate temperature
- Gravity-feed, requires the pump Inlet to be lower than liquid level
- 115 V



Z#	hp	price
G2907265	½	<b>\$140.41</b>
G1935857	¾	<b>\$186.11</b>

**LITTLE GIANT**  
**MD-HC Series**  
**Magnetic Drive Pump**

- For use with highly corrosive chemicals
- Gravity-feed, requires the pump inlet to be lower than liquid level
- ½s HP
- 115 V



Z#	price
G1765224	<b>\$115.55</b>

**INGERSOLL-RAND/ARO**  
**Air Operated Double**  
**Diaphragm Pump**

- Polypropylene body
- ½" inlet/outlet
- Ball valve
- ¼" FNPT air inlet
- 150° F max



Z#	price
G3028392	<b>\$340.93</b>

**INGERSOLL-RAND/ARO**  
**Air Operated Double**  
**Diaphragm Pump**

- Aluminum body
- 1" inlet/outlet
- Ball valve
- ¼" FNPT air inlet
- 150° F max



Z#	price
G2491422	<b>\$543.15</b>

**INGERSOLL-RAND/ARO**  
**Diaphragm Pump**  
**Repair Kits**

- Fluid section
- includes balls, diaphragms and seals*

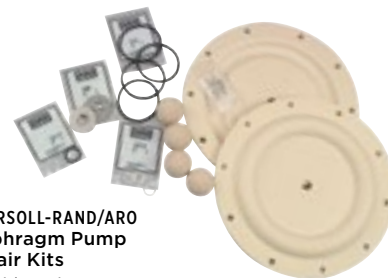

**Polyurethane**

Z#	price
G0757215	<b>\$71.09</b>

**Santoprene**

Z#	price
G1757813	<b>\$64.90</b>

**PTFE/Santoprene**

Z#	price
G1863653	<b>\$204.49</b>

**DAYTON**  
**Air Operated Double**  
**Diaphragm Pump**

- Polypropylene body
- PTFE ball
- ½" inlet/outlet
- ¼" FNPT air connection
- 180° F max



Z#	price
G2062575	<b>\$447.37</b>

**DAYTON**  
**Air Operated Double**  
**Diaphragm Pump**

- Aluminum body
- Buna N ball
- 1" inlet/outlet
- ¾" FNPT air inlet
- 180° F max



Z#	price
G1895817	<b>\$650.31</b>

**INGERSOLL-RAND/ARO**  
**Air Line Connection Kit**

- ¼", ½" and 1" pump ports
- Air Line filter/regulator with gauge (0-160 psi)
- FNPT air coupler, MNPT air connector
- Pipe nipple and 5 feet section of air hose MNPT at both ends



Z#	price
G2716971	<b>\$120.10</b>

**FLOJET**  
**Air Operated Double**  
**Diaphragm Pump**

- Self priming at 15' dry, 20' wet
- ½" inlet/outlet
- 80 psi max
- 3¼" w x 4½" l x 5¾" h



Z#	price
G0857202	<b>\$170.63</b>

**FLOJET**  
**Automatic Marine/RV**  
**Potable Water Supply Pump**

- Self priming at 6'
- ¾" inlet/outlet
- 30 psi max
- 12VDC
- 3¼" w x 8½" l x 3¾" h



Z#	price
G3071512	<b>\$99.21</b>

**FLOJET**  
**Potable Water Supply Pump**

- Automatic diaphragm
- Self priming at 9'
- ½" inlet/outlet
- 50 psi max
- 12 VDC



Z#	price
G1155113	<b>\$45.99</b>

**FILL-RITE Hand Operated Drum Pump**

- Ideal for gasoline, diesel fuel, light oil and kerosene
- Piston action, flow direction can be reversed
- 20 gpm
- 1" MNPT inlet
- 3/4" FNPT outlet

#	price
G1117383	<b>\$134.80</b>



**FILL-RITE Hand Operated Drum Pump**

- For gasoline, diesel, oils up to SAE 40, antifreeze and kerosene
- Rotary action
- 11.5 gpm
- 1" MNPT inlet
- 3/4" FNPT outlet

#	price
G2991834	<b>\$142.68</b>



**FILL-RITE Fuel Transfer Pump**

- Construction, agriculture applicatons
- Explosion proof motor, heavy duty switch, thermal overload protection, liter meter
- 3/4 HP - 35 gpm
- 115 and 230 VAC
- 1 1/4" MNPT inlet, 3/4" FNPT outlet

#	price
G1039796	<b>\$1,081.57</b>



**DAYTON Fuel Nozzles**

- For diesel and gasoline
- Manual operation
- 50 psi max
- 3/4" FNPT inlet
- Aluminum

#	spout	price
G1793267	curved	<b>\$33.28</b>
G1644194	straight	<b>\$31.21</b>



**DAYTON Rotary Drum Pump**

- Steel, cast iron, and buna rubber wetted materials
- 1" FNPT inlet
- 1" OD outlet
- 10 gpm @ 135 rpm
- Pump only; not for use with gasoline

#	price
G1520522	<b>\$82.46</b>



**FILL-RITE Fuel Nozzle**

- Aluminum body
- For diesel, gas and kerosene
- Automatic operation
- 1" FNPT inlet, 1" outlet
- 30 gpm

#	price
G4538502	<b>\$142.21</b>



**FILL-RITE Fuel Transfer Pump Repair Kit**

- Inlet screen, bypass valve and spring
- Rotor key, motor shaft seal
- 5 bronze vanes
- Rotor cover, rotor cover bolts, rotor cover gasket
- Bypass cap gasket, inlet gasket

#	price
G3140697	<b>\$104.88</b>



**FILL-RITE Fuel Hoses**

- For refined petroleum liquids
- Nitrile hose with static wire and spring guards
- Temperature rating -30° to 140° F
- 50 psi max

#	inlet/outlet	length	price
G2858527	3/4"	12'	<b>\$30.09</b>
G1628067	1"	14'	<b>\$36.22</b>



**FILL-RITE Liquid Flowmeter**

- Measures gasoline, diesel, kerosene and mineral spirits
- +/- 1% accuracy
- 1" mnpt connection
- 50 psi max
- 5 to 20 gpm

#	price
G2049451	<b>\$162.74</b>



**DAYTON Rotary Drum Pump**

- Made of polypropylene with 3-piece, 36 3/8" suction tube
- 1 1/2" ID, 1 1/4" OD inlet
- 2 3/8" ID, 1" OD outlet
- 8 gpm @ 135 rpm

includes bung adapter, repair kit and PTFE tape

#	price
G2663245	<b>\$104.25</b>



**DAYTON Rotary Drum Pump**

- Steel, cast Iron, buna materials
- For lubricating oils, Fuel oils, antifreeze
- 1" FNPT inlet
- 1 1/4" OD outlet
- 15 gpm @ 135 rpm

#	price
G1223643	<b>\$126.99</b>



**DAYTON Electric Operated Drum Pump**

- Carbon, CPVC, PVC, hastelloy, Viton wetted materials
- Use for chemical transfer
- 7 gpm oil, 35 gpm water
- 1.6" inlet, 1 1/2" outlet (barb)
- 115 VAC

#	price
G2277371	<b>\$1,053.27</b>



**GOATTHROAT PUMPS Piston Operated Drum Pumps**

- Use on 5 to 55 gal and Rieke Flex spout containers
- Hand-pressurized, spill proof, no VOCs, food grade
- 40" suction tube
- 9" length
- MEETS ROHS, ELV, WEEE, EPCRA, AND CA PROP. 65 STANDARDS

#	material	used for	color	price
G2744637	polypropylene, nitrile wetted materials	most lubricants, oils	red	<b>\$169.99</b>
G1110331	polypropylene, EPDM	most detergents and caustics	blue	<b>\$198.28</b>
G0564444	polypropylene, EPDM, santoprene	acetone and MEK acids, solvents,	blue	<b>\$234.87</b>
G0714201	polypropylene, Viton	pesticides, biodiesel	green	<b>\$289.32</b>





# PLUMBING

MORE THAN 800,000 ITEMS ONLINE

## ZOELLER

### Submersible Sewage Pumps

- 115V Automatic pumps with vertical floats
- Carbon/ceramic shafts
- Cast iron housings
- 2" max dia solids
- ■ UL LISTED, CSA CERTIFIED

Z#	base	HP	on point	off point	max head	price
G2973031	polypropylene	3/4	12 1/2"	4 1/2"	18"	<b>\$361.80</b>
G1291446	stainless steel	1/2	12"	5"	21"	<b>\$425.70</b>



## ZOELLER

### Submersible Sump Pumps

- Cast iron housing with polypropylene impeller
- Vertical switches
- Carbon/ceramic shaft seals
- 1 1/2" NPT discharge
- 115V
- 1/2" dia max solids

Z#	HP	off point	on point	max head	price
G0749481	3/4	3"	7 1/4"	19"	<b>\$179.37</b>
G3343225	1/2	3"	9 1/2"	23"	<b>\$277.20</b>

## ZOELLER

### Simplex Sewage System

- lifts waste water up to existing sewage lines
- Polyethylene construction
- Commercial and small industrial applications
- 4" inlet and 2" outlet
- 2" diameter solids (max)
- 1/4 HP
- 115V
- 60 gpm @ 10' head
- 18' max head
- 33 gal basin capacity
- 15' cord
- 18" d x 30" h



Z#	price
G0448953	<b>\$553.50</b>

## ZOELLER

### Primary Sump Pump w/ Battery Back Up System

- Cast iron pump with polypropylene base
- Residential use
- 1 1/2" NPT discharge
- 1/2" max dia solids
- includes battery charger and check valve*



Z#	price
G0982667	<b>\$610.20</b>

## LITTLE GIANT

### Submersible Sump Pump

- Cast iron housing with nylon impeller
- 3" off point
- 10" on point
- 18' max head
- 1/2 HP
- 115V



Z#	price
G3010987	<b>\$114.80</b>

## ZOELLER Sump Pump Hose

- Plastic hose
- For use with sump and effluent pumps in septic tanks and other basins
- 7 1/2" w x 12 1/2" l x 2 1/2" h
- includes hardware to attach to pump*



Z#	price
G1286485	<b>\$17.10</b>

## LITTLE GIANT

### Sump Pump Hose

- Polyethylene
- 1 1/2" d x 24' l
- includes: 1 1/4" and 1 1/2" adaptors*



Z#	price
G3746285	<b>\$7.53</b>

## LITTLE GIANT

### Simplex Sewage System

- For new basement toilet installations
- Polyethylene construction
- 4" inlet and 2" outlet
- 2" diameter solids (max)
- 1/4 HP
- 115V
- 50 gpm @ 10' head
- 18' max head
- 40 gal basin capacity
- 15' cord
- 20" d x 30" h



Z#	price
G1258214	<b>\$384.50</b>

## ZOELLER

### Septic Tank Filter

- Polypropylene construction
- For single family homes
- 1000 gpd
- 15" height



Z#	price
G0553393	<b>\$37.95</b>

## LEVELGUARD

### Electric Sump Pump Switch

- For 1/2 HP and under submersible sump pumps
- ABS plastic
- 9' cord
- 120V, 60 hz, single phase only
- includes pump switch, (5) zip ties and instruction booklet*



Z#	price
G4555932	<b>\$109.14</b>

## GOULDS WATER TECHNOLOGY

### Submersible Sewage Pumps

- Cast iron housing and impeller
- Silicon carbide shaft seals
- 460V 3-phase motors
- ■ UL LISTED, CSA CERTIFIED

Z#	base material	HP	max dia solids	max head	ntp discharge	size	price
G1831496	303 stainless steel	3	2 1/2"	54'	3"	15 1/2" d x 27 1/2" h	<b>\$2,315.55</b>
G1888853	303 stainless steel	5	2 1/2"	64'	3"	15 1/2" d x 27 1/2" h	<b>\$2,414.55</b>
G1949753	cast iron	7.5	3"	60"	4"	15 3/4" d x 28 3/4" h	<b>\$3,120.50</b>



eZTIPS  
technical resources

eZTips for sewage and effluent pumps are available online at [zoro.com/eztips](http://zoro.com/eztips)



**LITTLE GIANT Compact Submersible Pump**

- Aluminum pump with nylon impeller
- Continuous duty
- 11.8' max head
- 205 gph 5' head
- Hooded inlet, 1/4" MNPT outlet
- 1/40 HP
- 115 V

# price  
G1548897 **\$84.50**



**LITTLE GIANT Compact Submersible Pump**

- Polyester pump with nylon impeller
- Mild corrosive application
- 12.2 max head
- Hooded inlet, 1/2" MNPT outlet
- 1/40 HP
- 115 V
- ■ UL STANDARDS

# price  
G3323083 **\$72.92**



**DAYTON Utility Pump**

- Is designed for water transfer applications including emptying or filling tanks, lawn sprinkling, and drawing water from lakes and ponds
- 3/4" NPT inlet/outlet
- 101' max head
- 1/2 HP
- 115 V

includes 1" MFNPT x 3/4" garden hose adapters, suction strainer and (3) rubber feet for pump

# price  
G0570123 **\$191.94**



**LITTLE GIANT Utility Pump**

- Single phase thermally protected motor
- Non-clogging impeller
- Pumps down to 1/8" depth
- 18 gpm @ 5' head
- 115 V

# price  
G1203237 **\$99.99**



**DAYTON Utility Pump**

- Use to empty waterbeds, drain water heaters or aquariums, pump out basement, transfer water to RV, pump boat bilges, pump out stock tanks or water transfer
- Stainless steel body and shaft
- Universal AC/DC motor
- 1/10 HP
- 4" w x 6 3/4" l x 4 1/2" h

# price  
G0534021 **\$100.31**



**KASCO Fountain Lighting Systems**

- Bronze light housings
- 75 W halogen lamps
- 120 V

includes built in over temp, overload and short circuit protection with automatic reset

#	conduit size	cord length	price
G7117433*	16 AWG SJTOW	50'	<b>\$691.15</b>
G7225382*	17 AWG SJTOW	100'	<b>\$732.36</b>
G6782377*	18 AWG SJTOW	50'	<b>\$958.15</b>
G7221584*	19 AWG SJTOW	100'	<b>\$991.90</b>



**DAYTON Pool And Spa Pumps**

- Bronze with stainless steel impellers
- Self priming, capacitor start motors
- Max temp 180° F
- 115/230 V
- ■ CSA US, UL1081 STANDARDS

#	HP	gpm of water @ 10 ft of head	amperage	price
G3351932	1/2	53.2	9.2/4.7	<b>\$394.46</b>
G1813637	1	74.5	14.5/7.3	<b>\$446.54</b>
G0429511	1.5	94.3	19/9.5	<b>\$479.33</b>
G3358205	2	125	19.5/9.7	<b>\$635.78</b>



**RULE Submersible Marine Pump**

- For use in fresh water and salt water only
- Stainless steel shaft
- 9.5' max head
- 500 gph of water @ 0 ft of head
- 3/4" hose inlet
- 12 VDC

# price  
G1723985 **\$53.25**



**LITTLE GIANT Compact Submersible Pump**

- Aluminum pump with polypropylene impeller
- Continuous duty
- 17.3 max head
- 1/2" FNPT inlet, 1/2" MNPT outlet
- 1/5 HP
- 115 V
- ■ UL STANDARDS

# price  
G2522615 **\$110.24**



**DAYTON Pond Aerating Fountain System**

- Pumps with stainless steel housing and composite stages
- Vertical and floating in water installation
- Screen/flooded inlets
- Continuous duty
- (3) spray patterns sky cannon 41' high, trumpet 22' high, water lily 24'

includes ground fault Interrupter (GFI), rain proof control center with padlock eye, 24 hr adjustable timer and adjustable timer for optional light Kit, heat shrink splice kit for the motor electrical cable and (3) nozzle spray patterns

#	hp	voltage	gpm max	size	price
G2096254	1/2	230 V	81	14 1/2" w x 14 1/2" l x 32" h	<b>\$2,332.30</b>
G2330937*	1	230 V	102	20" w x 20" l x 39" h	<b>\$2,654.34</b>



**DAYTON Submersible Fountain Pumps**

- Brass with steel motor housing
- Stainless steel shafts with carbon and ceramic SS blades
- Continuous duty for waterfall and stream uses
- PSG motor
- Hooded inlet, 1/4" MNPT outlet
- 1/40 HP

#	hp	voltage	gpm max	price
G1583741	1/40	115 V	73	<b>\$1,034.18</b>
G1317443	1/20	115 V	80	<b>\$1,055.76</b>
G3397371	1/10	115 V	100	<b>\$1,056.59</b>
G2112512	1	230 V	108	<b>\$1,113.86</b>

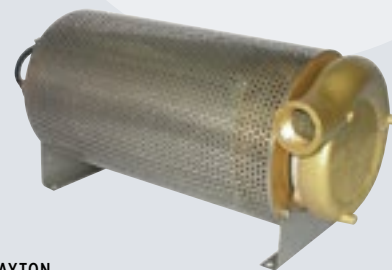



# PLUMBING

MORE THAN 800,000 ITEMS ONLINE

### TOTO Flushometer Toilet

- Commercial floor mount elongated bowl
- 1.28 gpf
- 14½" w x 25¼" d x 17½" h
- ■ ASME/CSA STANDARDS

Z# price  
**G6443927\* \$741.28**



### TOTO Toilet Tank and Bowl

- Two piece with an elongated bowl
- 1.6 gpf
- 19½" x 28" d x 28½" h
- 12" rough-in
- ■ ASME A112.19.2/CSA B45.1 STANDARDS

Z# price  
**G6524095\* \$295.87**



### TOTO Commercial Wall Mount Toilet Bowls

- High efficiency
- 1.28/1.6 gpf
- 9" x 12" water surface area
- 15¼" w x 18½" d x 16" h

Z# flushometer  
**G5405732 top spud**  
**G5417185 back spud**  
 each **\$265.19**

### TOTO One Piece Toilets

- Ultimate collection
  - 1.6 gpf
  - Gravity-fed single flush
  - Vitreous china
  - 12" rough-in
  - 10¼" x 8¼" water surface area
  - ■ ASME A112.19.2/CSA B45.1 STANDARDS
- includes soft close toilet seat*



### TOTO Bidet Toilet Seat

- Elongated
- 20½" bolt to seat front
- Seat surface temp. range 86° to 100° F
- Water supply pressure range 7 to 110 psi
- Power cord length 3.9'

Z# price  
**G7200137\* \$432.01**



### AMERICAN STANDARD Elongated Toilet Bowl

- 1.1 to 1.6 gpf
- 14" w x 29¼" d x 16½" h
- 12" rough-in

*includes bolt covers and features pressure-assisted siphon jet, Everclean surface inhibits the growth of stain and odor causing bacteria, mold and mildew, Right Height feature for accessible applications and sanitary dam and fully glazed trapway*

Z# price  
**G1719112 \$142.27**



### Round Bowl

- 16½" w x 26¼" d x 27½" h

Z# price  
**G6909603\* \$439.94**



### TOTO Slow Close Toilet Seat

- Elongated
- 18¾" bolt to seat front
- Polypropylene
- 14¼" x 2½" h

*includes mounting hardware*

Z# price  
**G7010297\* \$122.08**



### AMERICAN STANDARD Pressure Assist Tank

- 1.1 gpf
- 20½" w x 9" d x 14¼" h

*includes coupling components and tank cover and features metal trip lever, Everclean surface inhibits the growth of stain and odor-causing bacteria, mold and mildew*

Z# price  
**G3304585 \$317.23**



### Elongated Bowl

- 16½" w x 28¾" d x 27½" h

Z# price  
**G6985395\* \$464.39**



### AMERICAN STANDARD Gravity Fed Toilet Tank

- 1.28 gpf
- 17¾" w x 8¾" d x 13¾" h

*includes coupling components, tank cover, and EZ-install tools and features metal trip lever, metal shank fill valve, Everclean surface that inhibits the growth of stain and odor-causing bacteria, mold and mildew*

Z# price  
**G4604214 \$66.53**



### BEMIS Commercial Toilet Seats

- Stainless steel check hinges
- Sta-Tite commercial fastening system
- 14¼" width
- ■ FEDERAL SPECIFICATION WW-P-541/1A STANDARDS

Z#	shape	bolt to seat front	price
G0820023	elongated	18¾"	<b>\$19.83</b>
G3008774	round	16½"	<b>\$20.43</b>



### AMERICAN STANDARD Elongated Toilet Bowl

- 1.28 gpf
- 14" w x 29¾" d x 16½" h
- 12" rough-in

*includes bolt covers and features siphon jet, MaP score of 1,000 grams, Everclean surface that inhibits the growth of stain and odor causing bacteria, mold and mildew, Right Height feature for accessible applications, PowerWash rim scrubs bowl with each flush, and fully glazed trapway*

Z# price  
**G4588342 \$136.95**

**FREE** UPS Ground shipping on orders of \$50 or more\*

\$ prices subject to change

**SLOAN Manual Flush Valve**

- 1.6 gpf
- 1½" spud coupling
- Pressure range 25 to 100 psi
- 1½" rough-in
- ■ ASSE, ANSI, CSA, ADA STANDARDS

#	price
G2338831	<b>\$128.31</b>



**SLOAN Dual Flush Valve**

- 1.6/1.1 gpf
- 1½" spud coupling
- Pressure range 25 to 100 psi
- Lift handle up for liquid waste, pull down handle for solid waste
- ■ ASSE, ANSI, ADA STANDARDS

#	price
G1234956	<b>\$133.52</b>



**SLOAN Automatic Flush Valve**

- Converts manual to automatic
- Top mounting position
- 1.6 or 3.5 gpf
- Pressure range 15 to 100 psi
- Battery life 3 yr @ 4000 flushes/month

#	price
G2800506	<b>\$267.94</b>



**SLOAN Flushometer Rebuilding Kits**

- For use with Regal flush valves

#	type
G3199052	urinal 1.5 gpf
G2642473	toilet 3.5 gpf
G3230114	toilet 4.5 gpf

each **\$9.53**



**SLOAN Vacuum Breaker Kit**

- For use with Regal flush valves

#	price
G3478194	<b>\$2.14</b>



**SLOAN Electronic Modules**

- For use with G2

#	for use with	price
G1021614	toilets	<b>\$106.97</b>
G2263457	urinials	<b>\$126.50</b>



**FLUSHMATE Pressure Assist System**

- 1.6 gpf
- Polypropylene
- OEM toilets except Kohler K4404 tank and Gerber 28-385 tank
- ■ IAPMO, ASSE, CSA STANDARDS

includes mounting hardware

#	price
G2136233	<b>\$90.89</b>



**KORKY Fill Valve**

- For Toto GMAX and power gravity toilets
- Plastic and rubber
- ■ CUPC, ASSE STANDARDS

#	price
G4560044	<b>\$18.63</b>



**FLUIDMASTER Toilet Repair Kit**

- Fits most toilets
  - ■ IAPMO, ASSE, AND CSA STANDARDS
- includes fill valve, flush valve, bowl gasket and bolts and tank lever

#	price
G2929972	<b>\$17.68</b>



**VALUE BRAND Toilet Bowl Gasket**

- Wax ring
- For 3" and 4" waste lines
- 100% total recycled content
- ■ FEDERAL SPECIFICATION TT-P-1536A STANDARDS

#	price
G5313341	<b>\$1.83</b>



**KORKY Toilet Hinge Flapper**

- Rubber
- Fits specific one-piece Kohler toilet models

#	price
G1965302	<b>\$3.67</b>



**VALUE BRAND Forced Cup Plunger**

- Durable rubber plunger
- 6" cup
- 21" wood handle

#	price
G3183171	<b>\$6.49</b>



# PLUMBING

MORE THAN 800,000 ITEMS ONLINE

## SLOAN High Efficiency Urinal Systems

- Wall hung
- Vitreous china
- Washdown
- 3/4" IPS connection
- 17" w x 14 1/4" d x 27" h
- ■ ADA, AMSE A112.19.2, ASSE 1037 SATNDARDS

Z#	gpf	flushometer	price
G8535651	.25	manual	<b>\$374.19</b>
G8535667	.13	battery operated sensor	<b>\$514.51</b>



## AMERICAN STANDARD Washout Urinal

- Vitreous China
- Wallhung
- 3/4" connection
- 1 gpf
- 12 3/4" w x 12 3/4" d x 18" h
- ■ ASME A112.19.2 STANDARDS
- includes wall hanger*

Z#	price
G2122766	<b>\$121.63</b>

## SLOAN Waterfree Urinal

- Odor free
- 2" spud outlet
- Cartridges required
- 19 1/4" w x 14 3/8" d x 26 1/4" h

Z#	price
G1042273	<b>\$367.45</b>



## SLOAN Waterfree Urinal Cartridge Kit

- Designed for 7000 uses
- Made of recyclable ABS
- 100% biodegradable sealant liquid
- includes cartridge key, protective glove and disposal bag*

Z#	price
G0611186	<b>\$41.82</b>



## SLOAN Battery Operated Retrofit Kit

- Converts toilets or urinals to automatic
- 15 to 100 psi
- 3 year battery @ 3000 flushes/month
- Sensor range 8" to 54"

Z#	price
G2095877	<b>\$157.13</b>



## SLOAN Waterfree Urinal Cleaner Starter Kit

- (1) trigger sprayer
- (1) green clean concentrate
- (1) 32 oz bottle

Z#	price
G0451622	<b>\$19.86</b>



## VALUE BRAND Urinal Spud

- For use with most urinals
- Constructed of brass and rubber
- 1 1/4" x 3/4"

Z#	price
G0858602	<b>\$2.77</b>



## WATERLESS NO-FLUSH URINAL Waterless Urinal Trap Insert

- Polyethylene
- 7,000 uses

Z#	price
G2369647	<b>\$7.65</b>



## WATERLESS NO-FLUSH URINAL Waterless Urinal Drain Seal Liquid

- 100% biodegradable liquid sealant
- 15,000 uses
- 1 qt

Z#	price
G2947454	<b>\$19.42</b>



## ZURN INDUSTRIES Battery Operated Retrofit Kit

- Converts toilets or urinals to automatic
- Requires 4 "C" batteries
- Side mount
- Sensor range 12" to 44"
- ■ ADA COMPLIANT, ANSI, ASSE, IAPMO/UPC, CSA AND ETL TEST LABS STANDARDS
- includes (4) C batteries and installation tools*

Z#	price
G2235493	<b>\$168.89</b>



## WATERLESS NO-FLUSH URINAL Waterless Urinal

- HPC fiberglass
- Cartridges required
- 16 1/4" w x 14" d x 28" h
- ■ IAPMO STANDARDS
- includes mounting hardware*

Z#	price
G5172474	<b>\$472.28</b>



## WATERLESS NO-FLUSH URINAL Waterless Urinal Cleaner

- Cleans and deodorizes
- Rated life 4 years
- 1 qt

Z#	price
G3517105	<b>\$16.02</b>

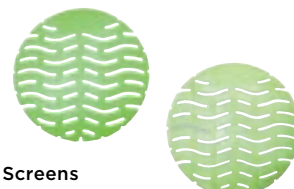

## TOUGH GUY Wave Urinal Screens

- Contains enzymes
- 10 pack

Z#	price
G2478323	springtime
G3458472	cucumber melon
each <b>\$30.11</b>	

**GLOBAL STEEL Bathroom Partitions**

- Steel construction
- Powder coat finish
- Floor anchored overhead braced
- Double overall size: 72" w x 60" l x 82" h
- Single overall size: 61" w x 62" l x 82" h

includes theft resistant mounting hardware

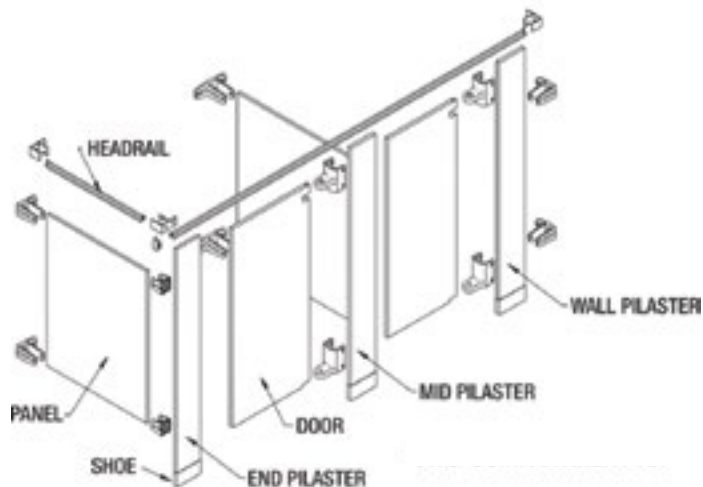
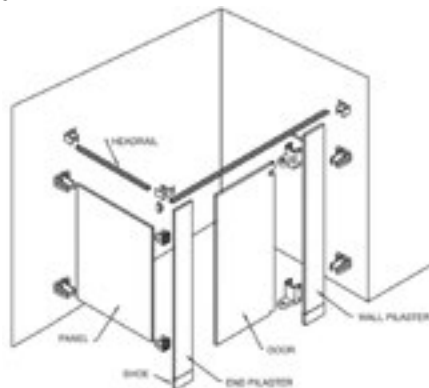

**Two Compartment - Gray**

Q#	size	item	qty. needed	price
G1664686	24"	door	1	<b>\$147.78</b>
G1055406	5"	pilaster	1	<b>\$71.54</b>
G3049313	7"	pilaster	1	<b>\$81.77</b>
G3001844	12"	pilaster	1	<b>\$107.32</b>
G2217616	58"	panel	2	<b>\$171.03</b>
G0503946	62"	headrail	1	<b>\$22.83</b>
G1953865	72"	headrail	1	<b>\$30.89</b>
G1409292*	—	headrail return	2	<b>\$8.24</b>
G2767125	—	panel bracket	1	<b>\$14.09</b>
G0428093	—	panel bracket	1	<b>\$9.99</b>
G3348037	—	pilaster bracket	1	<b>\$10.57</b>

**Single Compartment - Almond**

Q#	size	item	qty. needed	price
G0343542	36"	door	1	<b>\$182.05</b>
G2499497	3"	pilaster	1	<b>\$61.35</b>
G3412351	22"	pilaster	1	<b>\$148.19</b>
G2279645	60"	panel	1	<b>\$171.03</b>
G0503946	62"	headrail	2	<b>\$22.83</b>
G1409292*	—	headrail return	2	<b>\$8.24</b>
G2767125	62"	end panel	1	<b>\$14.09</b>
G3348037	—	panel bracket	1	<b>\$10.57</b>

**Single Compartment - Gray**

Q#	size	item	qty. needed	price
G2846681	36"	door	1	<b>\$182.05</b>
G2484553	3"	pilaster	1	<b>\$61.37</b>
G3270181	22"	pilaster	1	<b>\$148.19</b>
G3425834	60"	panel	1	<b>\$171.03</b>
G0503946	62"	headrail	2	<b>\$22.83</b>
G1409292*	—	headrail return	2	<b>\$8.24</b>
G2767125	62"	end panel	1	<b>\$14.09</b>
G3348037	—	panel bracket	1	<b>\$10.57</b>

**GLOBAL STEEL Urinal Partition**

- Baked enamel steel construction
- Cellular honeycomb inner core
- Theft resistant fasteners
- Powder coat finish
- 18" d x 42" h x 1" thick

includes mounting hardware

Q#	color
G2494073	gray
G0614354	almond

each **\$110.48**



**GLOBAL STEEL Stop and Keeper**

- Zamac construction
- For 1 1/4" thick pilasters

includes (2) each barrel nut #10 x 3/8" and (2) each step bolts 1 1/4"

Q#	price
G2977301	<b>\$5.87</b>



**GLOBAL STEEL Bumper and Coat Hook**

- Zamac construction
- Theft resistant fasteners
- 1" x 3"

includes (2) #10 x 3/8" screws

Q#	price
G1041241	<b>\$4.69</b>



**VALUE BRAND Toilet Partition Grab Bars**

- Stainless steel
- Wall mount
- 250 lb capacity
- ADA compliant
- 48" length

includes stainless steel mounting screws

Q#	diameter	finish	price
G0587404*	1 1/4"	satin textured	<b>\$101.51</b>
G1888686*	1 1/2"	satin textured	<b>\$108.85</b>
G3310246*	1 3/4"	satin	<b>\$90.69</b>



**GLOBAL STEEL Concealed Latch Door Set**

- Zamac construction
- Theft resistant fasteners

includes Zamac bracket one ear, bushing, nylon pin, bottom, pintle, washer, washer external, nut 5/16-18, knob concealed latch male/female, bumper and coat hook, (5) each step bolts 1 1/4", (5) each barrel nuts #10 x 3/8", (2) each screws #10 x 3/8", stop & keep and step bolt 1/2"

Q#	price
G3329891	<b>\$15.27</b>



**GLOBAL STEEL ADA Concealed Latch Knobs**

- Zamac construction
- Theft resistant fasteners
- Use with steel partition
- 4 1/4" w x 1 1/2" d x 1 1/2" thick

Q#	price
G2405216	<b>\$11.74</b>



**ENCORE Anti-Microbial Grab Bars**

- Smooth stainless steel construction
- 250 lb capacity
- 1 1/2" diameter
- Concealed mounting screws

includes mounting hardware

Q#	size	price
G2078054	16"	<b>\$50.59</b>
G0459785	18"	<b>\$52.09</b>
G2916051	24"	<b>\$53.55</b>
G2643977	36"	<b>\$69.68</b>
G1713092	42"	<b>\$77.75</b>
G1891057	48"	<b>\$103.25</b>

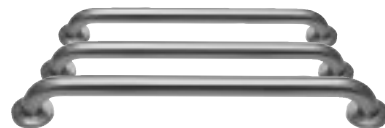



# PLUMBING

MORE THAN 800,000 ITEMS ONLINE

## FOUNDATIONS

### Baby Changing Stations

- Polyethylene construction

Z#	orientation	size	price
G5274762	horizontal	34 3/4" x 15 3/8"	<b>\$232.04</b>
G5274796	vertical	19 1/2" x 32"	<b>\$169.90</b>



### SEE ALL INDUSTRIES Framed Mirrors

- 1/4" plate glass mirror
- Galvanized mounting back plate and theft proof mount
- Stainless steel frame

Z#	size	price
G5284115	18" w x 1" d x 24" h	<b>\$110.55</b>
G5284081	18" w x 1" d x 30" h	<b>\$125.58</b>
G5284063	24" w x 1" d x 36" h	<b>\$164.36</b>

### DAYTON Low Profile Hand Dryer

- Automatic activator with fixed nozzle
- Cast aluminum cover
- White epoxy finish
- 115/200/230 V
- ADA STANDARDS

Z#	price
G2920802	<b>\$282.82</b>



### DYSON Wall Mount Hand Dryer

- Automatic activation
  - 12 second dry time
  - 104° F max temperature
  - 1400 W
  - 115V
  - 11 7/8" w x 9 3/4" d x 26" h
  - ETL STANDARDS
- includes mounting hardware and template

Z#	price
G6089587	<b>\$1,347.75</b>



### FOUNDATIONS Waterproof Changing Station Liners

- 2 ply tissue with polypropylene backing
- 13" x 19"
- 500 pack

Z#	price
G5274771	<b>\$40.17</b>



### TOUGH GUY Toilet Seat Cover Dispenser

- Chrome plated finish
  - 250 sheet capacity
  - 1/2 fold
  - 16 1/2" w x 17 1/8" d x 11 1/2" h
- includes screws

Z#	price
G3395165	<b>\$31.39</b>



### TOUGH GUY Toilet Seat Covers

- 1/2 fold
- 20 pack
- 5000 sheets per pack

Z#	price
G1108222	<b>\$76.80</b>



### HOSPECO Sanitary Product Dispenser

- Metal construction
- Dispenses tampons and pads
- 9 3/8" w x 11 3/8" l x 28 1/2" h

Z#	price
G5021904	<b>\$209.13</b>



### GEORGIA-PACIFIC Hand Towel Dispensers

- Wall mounted
- 1 Roll capacity (320 sheets)
- 9 1/4" w x 8 3/4" d x 11 1/2" h

Z#	color	price
G1333631	splash blue	<b>\$15.64</b>
G0870116	translucent smoke	

each



### GEORGIA-PACIFIC Hand Towels

- 320 sheet roll
- 6 pack

Z#	price
G1651937	<b>\$45.19</b>



**CHICAGO FAUCETS**  
**Utility Sink Faucet**

- Cast brass construction with rough chrome finish
  - Quatern valves
  - 1/2" fntp connection
  - 7 7/8" to 8 3/8" adjustable mounting hole to center
- includes vacuum breaker, 3/4" hose outlet, pail hook and wall bracket*

#	price
G1339326	<b>\$91.34</b>



**VALUE BRAND Braided Water Connectors**

- For faucets
- Triple reinforced PVC inner core
- 125 psi max
- Brass nut
- ■ IAPMO, NSF61 STANDARDS



#	inlet	outlet	length	price
G4135126	3/8" comp	3/8" comp	12"	<b>\$2.78</b>
G4229443	3/8" comp	3/8" comp	20"	<b>\$3.38</b>
G3984346	3/8" comp	1/2" FIP	12"	<b>\$3.07</b>
G4097834	3/8" comp	1/2" FIP	16"	<b>\$3.17</b>
G3989106	3/8" comp	1/2" FIP	20"	<b>\$3.67</b>
G3948567	1/2" FIP	1/2" FIP	20"	<b>\$4.03</b>

**GERBER**  
**Service Sink**

- Cast iron with stainless steel rim guard
- 9" back splash
- 3" drain opening
- 8" faucet mounting centers
- 22" w x 18" l x 20 1/4" h

#	price
G2940287	<b>\$393.84</b>



**MUSTEE**  
**Laundry Tub**

- Thermoplastic construction
  - 1 1/2" drain openings
  - 20" w x 24" l x 34" h
  - ■ IAPMO STANDARDS
- includes wall brackets*

#	price
G0357497	<b>\$70.30</b>



**MUSTEE**  
**Utility Sinks**

- Thermoplastic construction
- 4" faucet mounting centers
- 1 1/2" drain opening
- 20" x 24" bowls

#	type	size	price
G3356062	single tub	20" w x 24" l x 34" h	<b>\$50.89</b>
G3195421	double tub	40" w x 24" l x 34" h	<b>\$123.09</b>



**MUELLER INDUSTRIES**  
**P-Trap**

- PVC schedule DWV
- 1 1/2" pipe size
- Hub and socket connection
- Max temperature 140° F
- ■ MEETS OR EXCEEDS CLASS 12454 STANDARDS

#	price
G2126826	<b>\$8.12</b>



**FIAT PRODUCTS**  
**Laundry Tub Kit**

- Fiberglass reinforced polyester resin
  - 20" w x 24" l x 34" h
- includes mounting legs and hardware, P-Trap, supply lines, chrome plated faucet, tailnut and stopper*

#	price
G2671846	<b>\$149.92</b>



**MUSTEE**  
**Mop Sink**

- Made of durastone
  - 24" w x 24" l x 10" h
- includes drain seal and stainless steel strainer*

#	price
G1548023	<b>\$151.49</b>



**TRUEBRO**  
**Pipe Protectors**

- P-Trap cover
- (2) valve covers
- Constructed of molded vinyl
- ■ ADA ARTICLE 4.19.4, CABO/ANSI 4.20.4, UFAS 4.19.4, CALIF. TITLE 24, UBC, IBC, ICC, CANADA BARRIER-FREE CODE STANDARDS

#	price
G1719742	<b>\$24.58</b>



**FIAT PRODUCTS**  
**Mop Sink Kit**

- Fiberglass reinforced polyester resin
  - 24" w x 24" l x 10" h
- includes integral drain 3" quick drain connect, stainless steel strainer plate, 830AA dual handle wall mounted faucet, hose and holder combination and 889cc mop hanger*

#	price
G1980002	<b>\$418.59</b>

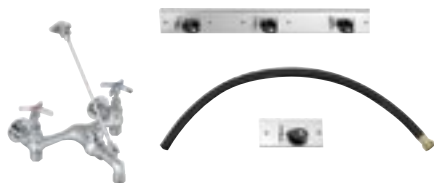



# PLUMBING

MORE THAN 800,000 ITEMS ONLINE



### ACORN Penal Bathroom Sink

- Stainless Steel
- Push button faucet operation
- 1½" drain opening
- 18" w x 18" d x 12¾" h
- Sound deadened with fire resistant material and non hold open metering, push button valve using atmospheric air for bubbler
- ■ ADA STANDARDS

Z#	price
G0845257	<b>\$1,026.01</b>

### ELKAY Scullery Sinks

- 18 gauge stainless steel
- 25<sup>13</sup>/<sub>16</sub>" w x 36<sup>1</sup>/<sub>2</sub>" l x 43<sup>3</sup>/<sub>4</sub>" h
- Bowl measures 16" w x 12" d x 20" l with 3½" drain
- 9" backsplash
- 8" faucet mounting centers
- ■ NSF STANDARDS

Z#	price
G4659322	<i>left hand</i>
G4696973	<i>right hand</i>
each	<b>\$403.79</b>



### ACORN Combination Toilet

- Suicide resistant with lavatory
- 14 gauge 304 stainless steel
- 1.6 gpf
- 18" w x 33¾" l x 36½" h
- includes mounting hardware for walls up to 8" thick, integral self draining soap dish and air-control pneumatically operated pushbutton valve

Z#	price
G0523031*	<b>\$2,998.40</b>

### EAGLE GROUP Stainless Steel Utility Sink

- 16 gauge
- Bowl measures 18" w x 13¼" d x 12" l
- Overall size is 25" w x 19¾" d x 39½" h
- 1½" drain opening
- 8" faucet mounting centers

Z#	price
G3238627	<b>\$680.03</b>



### ELKAY Drop-In Stainless Steel Sinks

- 23 gauge
- 2" drain opening
- Bowl measures 12" w x 5½" d x 10" l
- 15" w x 5¾" d x 15" l
- Not ADA compliant

Z#	price
G2653682	<b>\$108.52</b>



### EAGLE GROUP Hand Sink with Faucet

- Stainless steel
- Wall mount
- 14¾" w x 18¾" d x 14¼" h
- Bowl measures 13½" w x 6¾" d x 9¾" l
- 1½" drain
- 7½" backsplash
- ■ NSF STANDARDS

Z#	price
G2530157	<b>\$193.10</b>

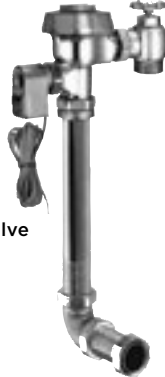

### SLOAN Automatic Prison Flush Valve

- 1.6 gpf
- 1" inlet
- 1½" spud coupling
- 15 to 100psi
- includes 15' cord and 3¼" flush connection

Z#	price
G0956033	<b>\$543.54</b>



### ELKAY Drop-In Stainless Steel Sinks

- Fully undercoated
- 23 gauge stainless steel
- Satin finish

Z#	size	price
G0292363	<i>single bowl</i>	<b>\$42.44</b>
G2709007	<i>double bowl</i>	<b>\$64.61</b>

### SANI-LAV Hands Free Sink

- 18 gauge stainless steel
- Wall mount
- Single knee pedal
- 8" backsplash
- 15¼" w x 16" l x 13" h
- ■ NSF / ANSI 372 STANDARDS

Z#	price
G5012725	<b>\$394.37</b>



### ADVANCE TABCO Splash Mounted Faucet

- Utility sink faucet
- 12" long
- 8" center to center mount
- Swing spout

Z#	price
G4207707	<b>\$154.11</b>

### VALUE BRAND Grid Strainer

- Chrome plated brass
- 1¼" pipe diameter
- 8½" long
- Slip connection

Z#	price
G0451281	<b>\$9.43</b>



### VALUE BRAND Lavatory P-trap

- Chrome plated brass
- 17 gauge
- 1¼" pipe diameter
- Slip connection
- includes slip nuts and washer

Z#	price
G3425651	<b>\$13.89</b>





**T&S Kitchen Faucet**

- Brass with chrome finish
- 2 hole with 8" mounting hole center to center
- 1/2" connection
- 2.2 gpm 12" spout
- ■ ISO, CSA, ANSI/NSF 61 STANDARDS

#	price
G0805734	<b>\$104.85</b>



**SLOAN Sensor Lavatory Faucet**

- Brass with chrome finish
- 2" to 7" sensor range
- 4 5/16" spout
- 6 VDC
- 3 hole with 4" mounting hole center to center
- includes (4) alkaline batteries*

#	price
G2558884	<b>\$406.23</b>



**CHICAGO FAUCETS Kitchen Faucet**

- Cast brass with chrome finish
- 3 hole with 8" mounting hole center to center
- 1/2" NPSM connection
- 2.2 gpm
- 5 1/4" spout
- ■ ADA, CSA, ASME/ANSI, NSF61, CALIFORNIA LEAD LAW, AB1953 STANDARDS

#	price
G0969814	<b>\$193.26</b>



**SLOAN Gooseneck Sensor Lavatory Faucet**

- Brass with chrome finish
- 4" to 7" sensor range
- 5 1/4" spout
- 6 VDC
- 4" mounting hole to center
- includes (4) alkaline batteries*

#	price
G1534495	<b>\$241.77</b>



**SLOAN Sensor Lavatory Faucet**

- Brass with chrome finish
- 4" to 7" sensor range
- 3 7/8" spout
- 6 VDC
- 4" mounting hole center to center
- includes (4) alkaline batteries*

#	price
G0319611	<b>\$250.73</b>



**TRIDENT Brushed Nickel Lavatory Faucet**

- 1/2" MIPS connection
- 2.2 gpm
- 6" to 12" mounting hole center to center
- Pop-up drain
- ■ ANSI A117.1, ASME A112.18.1, CSA B 125 AND NSF 61/SECTION 9 AND ANNEX G STANDARDS
- includes metal drain assembly and flexible hose*

#	price
G1221972	<b>\$67.58</b>



**CHICAGO FAUCETS Quatern Cartridges**

- Brass
- For use with lavatory faucets
- 3 3/8" x 1"

#	hand
G0959786	left
G1411751	right
each <b>\$19.68</b>	



**SPEAKMAN Mount Shower Head**

- Chrome
- 1/2" npt connection
- 4 1/4" face diameter
- 2.5 gpm
- ■ ANSI A112.18.1M STANDARDS

#	price
G0699027	<b>\$33.15</b>



**T & S Spindle Kit**

- For use with Eterna spindle assemblies
- includes left side and right side inserts and (2) gaskets*

#	price
G0696035	<b>\$8.96</b>



**T & S Faucet Cartridges**

- Brass with chrome finish
- 1 1/2" x 3/4"
- includes barrel*

#	item
G2593543	hot
G2560065	cold
each <b>\$6.82</b>	



**TRIDENT Handheld Showerhead**

- Chrome plated plastic construction
- Three spray settings, massage setting
- 59" hose and mounting bracket
- 2.5 gpm
- 1/2" MIPS connection

#	price
G2023445	<b>\$41.44</b>





# PLUMBING

MORE THAN 800,000 ITEMS ONLINE

## IN-SINK-ERATOR Badger Waste Disposals

- 1½" drain connection
- Fits 3½" outer diameter sink opening
- 26 oz grinding capacity
- 12½" height
- 120V



Z#	hp	badger	price
G2644652	½	5	<b>\$87.08</b>
G1038387	¾	5XP	<b>\$128.75</b>

## IN-SINK-ERATOR Evolution Compact Waste Disposals

- Stainless steel grind chambers with 2 stage shredder
- Intermittent duty cycle
- 1½" drain connection
- Fits 3½" outer diameter sink opening
- Sound insulation
- ¾ HP
- 120V



Z#	height	grinding capacity	price
G2770704	12½"	35 oz	<b>\$216.08</b>
G1649812	12½"	40 oz	<b>\$223.99</b>

## IN-SINK-ERATOR Badger Waste Disposer

- 1½" drain connection
- Fits 3½" outer diameter sink opening
- 26 oz grinding capacity
- Badger 1
- ½ HP
- 11¾" height



Z#	price
G0340173	<b>\$74.93</b>

## PURLOGIX Point-Of-Use Electronic Water Coolers

- Metal powder coated sides, metal frame, ABS front and top construction
  - 304 stainless steel resevoir
  - Hot and cold water temperatures
  - Reservoir holds 1.8 gal with 1.2 gal chilled, and separate 0.8 gal hot reservoir
  - 11¼" w x 16½" d x 49¼" h
  - Floor mount
- includes ultraviolet cooling tank bio-film control, solid state UV bulb and sleeve assembly*



Z#	price
G3925607	<b>\$973.60</b>

## PURLOGIX Point-Of-Use Electronic Water Coolers

- Metal powder coated sides, metal frame, ABS front and top construction
  - 304 stainless steel resevoir
  - Hot and cold water temperatures
  - Reservoir holds 1.2 gal with 0.5 gallons chilled and 0.5 gallons hot
  - 11¼" w x 16½" d x 20" h
  - Counter top
- includes ultraviolet cooling tank bio-film control, solid state UV bulb and sleeve assembly*



Z#	price
G4180407	<b>\$908.89</b>

## ELKAY Retrofit Bottle Filling Station

- Made of stainless steel and ABS plastic
  - For use with elkay 115 V/60 HZ pushbar activated EZ style single, bi-level and bi-level reverse water coolers
- includes 3000 gallon filter, EZH2O station and retro fit tools*



Z#	price
G2544351	<b>\$452.83</b>

## ELKAY Drinking Fountain Head

- For use with various elkay water coolers
- includes chrome cover, copper tube, retaining nut, and bubbler*



Z#	price
G0340006	<b>\$20.77</b>

## ELKAY Water Coolers

- Stainless steel tanks, copper components and lead-free materials
- Permanently lubricated compressor and fan cooled motor
- Deliver 50° F water
- ¾" OD tubing inlet and 1¼" drain
- 115V

### Indoor Wall Mounted

- Push-button activated
- ¼ HP compressor
- 8gph capacity
- 18¼" w x 18½" d x 20¼" h

Z#	price
G3233151	<b>\$390.45</b>



### Indoor Free Standing

- ½ HP compressor
- 3gph capacity
- 12" w x 12" d x 38" h

Z#	price
G1904052	<b>\$494.47</b>



## ELKAY Pushbar Activations

- For use with Elkay EZ and LZ bi-level models
  - 10" long
- includes pushbars*



Z#	price
G4393085	<b>\$26.89</b>

## AQUA-PURE Icemaker Filter

- Activated carbon
- Filters to 5 microns
- ¼" FPT
- Max pressure 125psi
- ■ NSF STANDARDS



Z#	price
G0577744	<b>\$22.99</b>

**ELKAY Replacement Filter Cartridge**

- Elkay water coolers and fountains with WaterSentry VII filtration system
- Use with G1479222 filter



Z #	price
G2246167	<b>\$59.89</b>

**ELKAY Water Cooler Filter**

- For use with most water coolers
  - Polypropylene and carbon construction
  - 12½" length
- includes filter mounting bracket and screws*



Z #	price
G1479222	<b>\$62.85</b>

**PURLOGIX Water Cooler Filter**

- For sediment
- Poly construction
- Fits Purlogix
- For use with mfr model number PMV-2000 and PCMV-1000
- 2½" x 11"



Z #	price
G2717206	<b>\$14.72</b>

**PURLOGIX Water Cooler Filter**

- Microcarbon filter
- Poly construction
- Fits Purlogix
- For use with mfr model number PMV-2000 and PCMV-1000
- 2½" x 11"



Z #	price
G1033837	<b>\$19.17</b>

**ELKAY Solenoid Valve**

- Fits various Elkay and Halsey Taylor water coolers



Z #	price
G3253817	<b>\$39.27</b>



**ELKAY Strainer**

- For various Elkay and Halsey Taylor water coolers

Z #	price
G1598493	<b>\$7.19</b>



**ELKAY Cold Control Thermostat**

- For various Elkay and Halsey Taylor water coolers
- includes cold control*

Z #	price
G0446564	<b>\$11.81</b>

**ELKAY Cartridge Regulator**

- Polypropylene
- For old style Halsey bubblers and some high-water pressure application
- 1⅜" long



Z #	price
G2177201	<b>\$23.98</b>



**ELKAY Push Button Assembly Kit**

- For various Elkay and Halsey Taylor water coolers
- includes cover, button, hex nut, regulator holder, regulator cartridge and retaining nut*

Z #	price
G1272187	<b>\$33.85</b>

**NORTH STAR Reverse Osmosis System**

- Reverse osmosis assembly, water storage tank, drain adapter kit, faucet assembly, three filters and mounting hardware
- 14.5 GPD output
- 2 cartridges required
- TFC membrane

Z #	price
G3375434	<b>\$240.88</b>



**Membrane**

- For north star reverse osmosis systems
- Max pressure 125 psl
- Max temp 100° F

Z #	price
G2503295	<b>\$80.21</b>



**Pre and Post Filters**

- For North Star reverse osmosis system
- 2 pack

Z #	price
G1644754	<b>\$39.57</b>



**IN-SINK-ERATOR Hot Water Dispenser**

- Stainless steel
- 190° F pre-set temperature
- ¼" connection
- ½ gal tank
- 115V

Z #	price
G0770402	<b>\$169.43</b>



**ELKAY Regulator Kit**

- For various Elkay and Halsey Taylor push bar activated water coolers
  - ¼" connection
  - 2" long
- includes regulator, holder, tube and hardware*

Z #	price
G4393067	<b>\$41.27</b>





# PLUMBING

MORE THAN 800,000 ITEMS ONLINE

### WEBSTONE Tankless Water Heater Service Valve

- Brass body
- 100° to 180° F
- PTFE seat material
- 398 to 500 psi
- 3/4" pipe

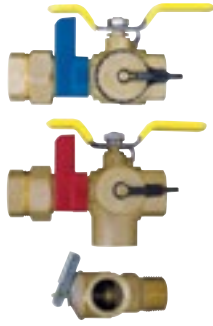

Z#	price
G5274053	<b>\$113.31</b>

### WATTS Tankless Water Heater Valve Set

- Valve and relief valve
- 3/4" connection
- ■ NSF/ANSI STANDARDS



Z#	price
G7224856*	<b>\$150.47</b>

### BOSCH Gas Tankless Water Heaters

- 74,900 BTU input
- 1.3 gpm @ 90° F rise
- 1/2" gas connection
- 1/2" water connection
- 12 13/16" x 8 1/2"
- ■ CSA AND ANSI Z21.10.4 STANDARDS

includes mounting bracket



Z#	type	height
G2630056	LP	22 3/4"
G1219172	NG	28 3/4"

each **\$384.50**

### BOSCH Point of Use Electric Water Heaters

- 120 VAC
- 12.5 A
- 65° to 140° F temperature range
- Factory installed T&P valves, 30" 1 1/3 cord
- ■ UL LISTED, CSA CERTIFIED



Z#	size	price
G2842156	2.5 gallon	<b>\$159.74</b>
G3114273	4 gallon	<b>\$161.99</b>

### BOSCH Electric Tankless Water Heater

- Whole house design
- 95° to 131° F
- 122° F default temperature
- 240 VAC
- 3/4" npt water connection
- Commercial/residential use
- ■ NATIONAL APPLIANCE ENERGY CONSERVATION ACT, UL LISTED



Z#	price
G0557453	<b>\$626.82</b>

### VANGUARD Residential Gas Water Heaters

- Natural gas
- Standing pilot ignition
- FVIR design
- 60° to 160° F
- 6000' altitude range

Z#	tank	BtuH	1st hour recovery	size	price
G1731651	40 gallon	38,000	73 gph	18 1/2" d x 58 1/2" h	<b>\$416.09</b>
G0445505	75 gallon	75,100	141 gph	26 3/4" d x 60" h	<b>\$739.78</b>



### VANGUARD Residential Electric Water Heaters

- 90° F to 150° F, preset @ 120° F
- 3/4" NPT connection
- 240 VAC
- ■ NATIONAL APPLIANCE ENERGY CONSERVATION ACT (NAECA), ASHRAE STANDARD 90 STANDARDS

includes brass drain valve and installed T and P valve



Z#	tank	size	price
G0502451	40 gal	19 1/4" d x 46 1/2" h	<b>\$313.30</b>
G2476853	80 gal	23" d x 59" h	<b>\$505.89</b>

### RHEEM-RUUD Commercial Electric Water Heaters

- 120 gal tank
- 120° to 180° F temperature range
- 30 1/4" d x 67 1/2" h
- 1 1/2" npt connection

includes system sentinel and dielectric nipples, T and P valve and full port drain valve

Z#	recovery @ 100° F rise	elements	VAC	watts	price
G2017601	74 gph	3	240	18,000	<b>\$2,787.21</b>
G1039525	149 gph	6	480	36,000	<b>\$4,514.03</b>



## e7TIPS

technical resources

### WATER HEATER SELECTION GUIDE

Water heaters are made to operate on natural gas, propane or electricity. When choosing which type of energy to use it is best to keep the same energy supply as the existing water heater. If the water heater is a new installation, the most efficient energy source for your area will work best.

fixture	GPM	average gallons per use	average temperature
tub	4	20	102° F
shower	2.5-3.0	20	104° F
washing machine	2	2	120° F
dishwasher	1.5	1.5	110° F
kitchen sink	1.5	1.5	110° F



**FLOODMASTER Water Heater Leak Detection System**

- Alarm and shut-off system
- For water tanks & water heater tanks
- High impact ABS, brass valve
- 12' cord
- 120 VAC

#	price
G4359083	<b>\$216.45</b>



**RHEEM-RUUD Water Heater Vent Package**

- Compatible with Rheem and Ruud commercial gas water heaters from 98,000 To 180,000 BTU
- Allows venting up to 50' away from a side wall
- Power venter with, 4" Inlet and outlet
- Pre-wired with 40' of #18-4 copper wire (24V)
- 115V

#	price
G1449673	<b>\$472.49</b>



**VALUE BRAND Water Heater Elements**

- Electric replacement elements
- 240V
- Nickel-based alloy sheath
- 1" NPSM screw plug and type AG-1 rubber gasket

#	watts	length	price
G2924171	2000	9 <sup>3</sup> / <sub>2</sub> "	<b>\$16.07</b>
G1805684	3500	13 <sup>3</sup> / <sub>8</sub> "	<b>\$21.49</b>
G1691837	4500	16 <sup>3</sup> / <sub>8</sub> "	<b>\$23.16</b>
G1305455	5000	19 <sup>3</sup> / <sub>4</sub> "	<b>\$29.26</b>
G2066976	6000	22 <sup>3</sup> / <sub>8</sub> "	<b>\$30.44</b>

**TJERNLUND Water Heater Vent Package**

- For where no chimney exists
- Allows venting up to 75' away from a side wall
- Compatible with any gas water heater up to 60,000 BTUs
- 115V

#	price
G1735027	<b>\$375.82</b>



**WHITE-RODGERS Natural Gas Water Heater Control**

- Pressure regulation main burner 3<sup>1</sup>/<sub>2</sub>" W.C.
- 56,000 Btu/h capacity
- 3/4" npt mounting
- 1/2" inlet/outlet
- 70° to 160° F range

#	price
G0806714	<b>\$84.54</b>



**VALUE BRAND Water Heater Platforms**

- Steel construction
  - 1" MIPT x 1" FS connection
- includes hardware*

#	supports	size	price
G4161001	20 gal/375 lb	22" w x 22" l x 2.5" h	<b>\$205.65</b>
G4041222	50 gal/600 lb	26" w x 26" l x 2.5" h	<b>\$254.93</b>



**VALUE BRAND Water Heater Drip Pans**

- Aluminum
- For electric or gas water heaters
- 1" PVC drain fitting
- 2 1/2" depth

#	dia	price
G4340944	22"	<b>\$22.59</b>
G4340953	24"	<b>\$23.54</b>
G4340962	26"	<b>\$31.18</b>
G4340987	30"	<b>\$51.25</b>



**RHEEM-RUUD Commercial Water Heaters**

- Spark to pilot ignition
- Integrated self-diagnostic systems
- Brass drain valves
- Factory installed T & P valves
- Standard vent



**Natural Gas**

#	tank	BtuH	recovery @ 100° F rise	degrees (°F)	size	price
G1871667	75 gallon	125,000	121 gph	100 to 180	26 <sup>3</sup> / <sub>4</sub> " d x 61" h	<b>\$2,489.99</b>
G0277715	100 gallon	199,900	194 gph	100 to 180	30 <sup>3</sup> / <sub>4</sub> " d x 66 <sup>3</sup> / <sub>8</sub> " h	<b>\$2,517.80</b>

**LP**

#	tank	BtuH	recovery @ 100° F rise	degrees (°F)	size	price
G1526646	75 gallon	65,000	60 gph	80 to 160	26 <sup>3</sup> / <sub>4</sub> " d x 60" h	<b>\$1,321.61</b>
G2778264	100 gallon	199,900	194 gph	100 to 180	30 <sup>3</sup> / <sub>4</sub> " d x 66 <sup>3</sup> / <sub>8</sub> " h	<b>\$2,566.55</b>

**VALUE BRAND Water Heater Drip Pans**

- Plastic
  - 2 1/2" depth
  - ■ IN ACCORDANCE WITH SOUTHERN BUILDING CODE INTERNATIONAL STANDARDS
- includes 1" PVC adapter with gasket and lock nut for connecting to 1" PVC pipe*

#	dia	price
G0743267	22"	<b>\$9.37</b>
G3197661	24"	<b>\$11.78</b>
G3058307	26"	<b>\$12.11</b>
G0305776	30"	<b>\$15.86</b>





# ELECTRICAL & TEST INSTRUMENTS



## TOP BRANDS



### CIRCUIT BREAKERS

pg  
72



### ENCLOSURES

pg  
73



### TOGGLE SWITCHES

pg  
75



### GENERATORS

pg  
88



### LIGHT BULBS

pg  
90



### WORK LIGHTS

pg  
95



### SECURITY LIGHT FIXTURES

pg  
97



### FLASHLIGHTS

pg  
100

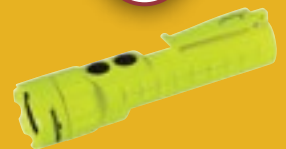

### BATTERIES

pg  
102



### VOLTAGE DETECTORS

pg  
104



**COOPER BUSSMANN**  
**BBS Series Nonindicating Fuses**

- Fast acting
- 600 VAC
- Fiberglass
- Functional equivalent to Ferraz Shawmut SBS
- ■ UL LISTED, CSA CERTIFIED, CE CERTIFIED



Q#	amperage	price
G0761993	1A	<b>\$5.76</b>
G2162027	5A	<b>\$6.70</b>

**LITTELFUSE**  
**KLKD Series Nonindicating Fuses**

- Solar
- Fast acting
- 600VAC/VDC
- Melamine
- ■ UL LISTED, CSA CERTIFIED, CE CERTIFIED



Q#	amperage	price
G4352187	1A	
G4352284	5A	
G4353842	15A	

each **\$10.11**

**COOPER BUSSMANN**  
**KTK-R Series Nonindicating Fuses**

- Fast acting
- 600 VAC
- Melamine
- Functional equivalent to Ferraz/Gould ATMR, Littelfuse KLK-R
- ■ CSA CERTIFIED, CE/UL CERTIFIED



Q#	amperage	price
G2298204	10A	
G3271152	20A	
G2072996	30A	

each **\$14.97**

**MERSEN**  
**ATMR Series Nonindicating Fuses**

- Fast acting
- 600 VAC/VDC
- Melamine
- Functional equivalent to Bussman KTK-R
- ■ UL LISTED, CSA CERTIFIED



Q#	amperage	price
G1292724	10A	
G2217451	15A	
G0959217	20A	
G0744046	30A	

each **\$6.49**

**COOPER BUSSMANN**  
**FNM Series Nonindicating Fuses**

- Time delay
- 250 VAC
- Fiberglass
- Functional equivalent to Ferraz/Gould TRM, Littelfuse FLM
- ■ UL LISTED, CSA CERTIFIED, CE CERTIFIED



Q#	amperage	price
G1871947	10A	<b>\$5.82</b>
G2251557	15A	<b>\$5.82</b>
G0701994	20A	<b>\$6.25</b>
G1141323	30A	<b>\$6.25</b>

**COOPER BUSSMANN**  
**FRN-R Series Nonindicating Fuses**

- Time delay
- 250 VAC/125 VDC
- Fiberglass
- Functional equivalent to Ferraz/Gould TR, Littelfuse FLNR
- ■ UL LISTED, CSA CERTIFIED, CE CERTIFIED



Q#	amperage	price
G3195717	15A	
G0668857	20A	
G1684304	30A	

each **\$5.94**

**COOPER BUSSMANN**  
**LP-CC Series Nonindicating Fuses**

- Time delay
- Melamine
- Functional equivalent to Ferraz ATDR
- ■ CSA CERTIFIED, CE/UL CERTIFIED



Q#	amperage	VAC/VDC	price
G2960842	10A	600/150	
G1886717	15A	600/150	
G0686847	30A	600/300	

each **\$17.94**

**FLUKE**  
**DMM Series Fuse**

- Fast acting
- 1000 VAC
- 440 mA



Q#	price
G2575526	<b>\$8.95</b>

**COOPER BUSSMANN**  
**FRS-R Series Nonindicating Fuses**

- Time delay
- 600 VAC
- Fiberglass
- Functional equivalent to Ferraz/Gould TRS, Littelfuse FLSR
- ■ UL LISTED, CSA CERTIFIED, CE CERTIFIED



Q#	amperage	VDC	price
G3374357	15A	300	<b>\$13.24</b>
G2396265	20A	300	<b>\$13.24</b>
G1203185	30A	300	<b>\$13.24</b>
G1400664	40A	250	<b>\$24.26</b>
G1633283	60A	250	<b>\$24.26</b>

**COOPER BUSSMANN**  
**SC Series Nonindicating Fuses**

- Time delay
- Melamine
- Functional equivalent to Ferraz/Gould AG1, Littelfuse SLC
- ■ UL LISTED, CSA CERTIFIED, CE CERTIFIED



Q#	VAC/VDC	amperage	price
G1950882	600/170	10A	<b>\$5.17</b>
G0250957	600/170	15A	<b>\$5.38</b>
G1474496	600/170	20A	<b>\$6.26</b>
G1984281	480/300	30A	<b>\$10.16</b>
G0643903	480/300	60A	<b>\$11.63</b>

**COOPER BUSSMANN**  
**In-Line Fuse Holder**

- Crimp connector
- 30A
- 600V max
- 12 to 8 cu wire
- For use with BAF, FNW, FNM, KTK, FNQ midjet fuses



Q#	price
G1222295	<b>\$19.22</b>

**COOPER BUSSMANN**  
**Fuse Links**

- 600 VAC
- 10 kA interrupt rating
- For use with Class H RES fuses
- 20 pack



Q#	amperage	price
G1570344	20A	<b>\$44.82</b>
G1066922	30A	<b>\$41.31</b>

**COOPER BUSSMANN**  
**Fuse Block**

- 30A
- 600V max
- For use with BAF, FNW, FNM, KTK, FNQ fuses

Q#	price
G1691812	<b>\$10.38</b>





# ELECTRICAL

MORE THAN 800,000 ITEMS ONLINE

## SQUARE D

### Load Centers

- 120/240 VAC
- Main lug, fixed
- Top or bottom feed
- Shielded plated copper bus
- ■ UL LISTED

includes cover



Z#	amperage	spaces	price
G3229186	30A	2	<b>\$15.65</b>
G1515114	70A	2	<b>\$23.11</b>
G0953811	100A	6	<b>\$32.47</b>
G0735524	100A	8	<b>\$51.87</b>

### PUSHMATIC UBIP Series UBIP Circuit Breakers

- Lug terminal
- Use with Pushmatic load centers
- ■ ETL LISTED



Z#	VAC	amperage	pole	price
G2923907	120	20	1	<b>\$17.29</b>
G1904122	240	50	2	<b>\$49.19</b>

### ZINSCO Plug-In Series UBIZ Circuit Breakers

- 120/240 VAC
- Lug terminal
- Use with Zinsco load centers
- ■ ETL LISTED



Z#	amperage	pole	price
G1569811	20/20A	1	<b>\$42.68</b>
G2294372	100A	2	<b>\$119.92</b>

## SQUARE D

### QO Series Plug-In Circuit Breakers

- Use with QO load centers and NQOD panelboards
- ■ UL, CSA, HACR



Z#	VAC	amperage	pole	terminal	price
G0879462	120/240	15A	1	screw clamp	<b>\$8.72</b>
G1088534	120/240	20A	1	screw clamp	<b>\$8.72</b>
G2818164	240	30A	3	screw clamp	<b>\$71.84</b>
G0304105	240	60A	3	box lug	<b>\$71.84</b>

## SQUARE D

### Load Center Covers

- For indoor use

Z#	spaces	mount	price
G1421393	16	surface	<b>\$13.37</b>
G1421777	20	flush	<b>\$13.37</b>
G2590332	24	surface	<b>\$13.37</b>
G0337407	30	flush	<b>\$25.01</b>



## SQUARE D

### HOM Series Plug-In Circuit Breakers

- Ground fault circuit interrupter
- Use with Homeline load centers
- 120/240 VAC
- ■ UL, CSA

Z#	amperage	terminal
G1716915	15A	screw clamp
G2581941	20A	screw clamp
G0672411	30A	screw clamp
G3329751	50A	lug

each **\$88.40**

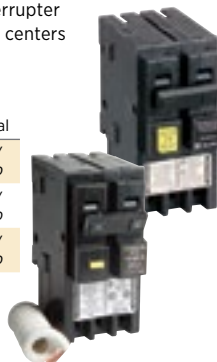

## SIEMENS

### Plug-In Series QF Circuit Breakers

- Ground fault circuit interrupter (Class A - 5 mA)
- Lug terminal
- Use with Siemens load centers

Z#	VAC	amperage	pole	price
G2196031	120/240	20A	2	<b>\$61.88</b>
G0950275	120	30A	1	<b>\$31.32</b>



## SQUARE D

### Panelboard Lock Kit

- Use with NQOD mono-flat fronts
- includes (1) key

Z#	price
G1117006	<b>\$45.99</b>



## CARLING TECHNOLOGIES

### Thermal Circuit Breakers

- Push button switch
- 1-pole
- 250 VAC/32 VDC
- ■ UL LISTED, CSA CERTIFIED, CE CERTIFIED, TUV STANDARDS



Z#	series	amperage	collar mount	price
G2950367	CMB	5A	3/8"	<b>\$3.30</b>
G3456582	CMB	5A	11mm	<b>\$2.12</b>
G2353443	CMB	10A	3/8"	<b>\$2.19</b>
G0528157	CMB	10A	11mm	<b>\$1.37</b>
G2733552	CMB	15A	3/8"	<b>\$1.82</b>
G1254827	CLB	15A	3/8"	<b>\$1.63</b>
G1364526	CLB	30A	3/8"	<b>\$1.92</b>

## SQUARE D

### Ground Bar Kit

- Type QO816LI00RB
- 7 terminals



Z#	price
G2672433	<b>\$4.66</b>

## SQUARE D

### Load Center/Panelboard Handle Attachment

- Handle attachment
- Converts single pole adjacent breakers to two pole
- For QO load center



Z#	price
G0602971	<b>\$2.49</b>

## SQUARE D

### Load Center/Panelboard Filler Plate

Z#	price
G1995427	<b>\$1.79</b>



## SQUARE D

### Load Center/Panelboard Trim Clamp

- Use with NQOD panels

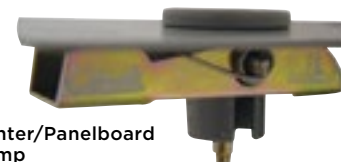

Z#	price
G3316065	<b>\$12.23</b>

**FREE UPS Ground shipping on orders of \$50 or more\***

\$ prices subject to change





**GENERAL ELECTRIC  
Nonmetallic Enclosures**

- Fiberglass reinforced polyester
- NEMA 3, 3R, 4, 4X, 12, 13
- No knockouts
- Hinged padlockable
- ■ UL, CE CERTIFIED, ROHS COMPLIANT

② #	dimensions	price
G1202826	7.31"wx4.92"dx9.31"h	<b>\$94.25</b>
G2453202	11.31"wx5.6"dx13.31"h	<b>\$101.23</b>
G3383457	13.31"wx6.6"dx15.31"h	<b>\$114.83</b>
G1730985	15.31"wx6.67"dx17.31"h	<b>\$134.83</b>
G1130507	17.31"wx9.58"dx19.31"h	<b>\$193.94</b>

**WIEGMANN  
Screw On  
Steel Enclosures**

- NEMA 1
- ■ UL, CSA, NEMA



**Knockouts**

② #	dimensions	price
G1861623	6"wx6"dx6"h	<b>\$14.26</b>
G3119261	8"wx4"dx8"h	<b>\$15.52</b>
G1883655	12"wx4"dx12"h	<b>\$26.93</b>

**No Knockouts**

② #	dimensions	price
G0769727	6"wx4"dx6"h	<b>\$14.44</b>
G2632287	8"wx6"dx8"h	<b>\$23.57</b>
G2354317	10"wx4"dx10"h	<b>\$23.51</b>
G0919746	12"wx6"dx12"h	<b>\$32.05</b>



**KILLARK  
Hazardous Location Enclosures**

- Aluminum
- NEMA 3, 4, 4X, 7 (B,C,D), 9 (E,F,G)
- ■ UL, CSA, FM

**Screw On**

② #	dimensions	price
G1074805	6.87"wx6.56"dx6.87"h	<b>\$453.13</b>
G1459647	8.87"wx7.97"dx10.5"h	<b>\$524.10</b>

**Bolt On**

② #	dimensions	price
G0632931	12.32"wx8.09"dx12.32"h	<b>\$1,294.93</b>
G2814235	16.38"wx8.69"dx16.38"h	<b>\$2,186.00</b>

**WIEGMANN  
Hinged Steel Enclosures**

- ■ UL, CSA

**Non Padlockable (no knockouts)**

② #	NEMA	dimensions	price
G2892583	3R, 4, 4X, 12	6"wx3.5"dx8"h	<b>\$87.24</b>
G1321196	1	12"wx6"dx12"h	<b>\$86.57</b>
G0702213	1	12"wx8"dx14"h	<b>\$93.65</b>

**Padlockable (with knockouts)**

② #	NEMA	dimensions	price
G0456592	3R	8"wx6"dx8"h	<b>\$59.01</b>
G3279595	3R	10"wx6"dx12"h	<b>\$62.88</b>



**WIEGMANN  
Wiring Troughs**

- Galvanized steel
- NEMA 3R
- Knockouts
- Screw on
- ■ UL, CSA



② #	dimensions	price
G0482325	4"wx24"dx4"h	<b>\$62.71</b>
G0885026	6"wx24"dx6"h	<b>\$86.83</b>

**HOFFMAN  
Pull Box Enclosures**

- Carbon steel
- NEMA 1
- Knockouts
- Screw on
- ■ UL, CSA, IEC, cUL



② #	dimensions	price
G7448497	4"wx4"dx4"h	<b>\$13.72</b>
G7456897	6"wx6"dx6"h	<b>\$39.87</b>
G7450825	12"wx4"dx12"h	<b>\$47.70</b>
G7458552	30"wx12"dx30"h	<b>\$666.65</b>

**SQUARE D  
Steel Bolt On Enclosures**

- Gray painted steel
- NEMA 1
- No knockouts



② #	dimensions	price
G3064415	4.87"wx7.53"dx7.79"h	<b>\$80.85</b>
G0937431	7.53"wx5.91"dx9.78"h	<b>\$116.85</b>

**RITTAL  
Hinged Steel Enclosures**

- Powder coated carbon steel
- NEMA 3R, 4, 12
- ■ UL, CUL



② #	knockouts	dimensions	price
G1627306	no	11.8"wx5.9dx11.8"h	<b>\$130.06</b>
G0342666	yes	13.8"wx7.9"dx15.7"h	<b>\$178.21</b>



**HOFFMAN  
Hinged Junction Box Enclosures**

- Carbon steel
- NEMA 3R
- No knockouts
- ■ UL, CSA, IEC, cUL

② #	dimensions	price
G7586957	12"wx6"dx16"h	<b>\$137.75</b>
G7451105	16"wx6"dx16"h	<b>\$214.80</b>
G7532296	16"wx6"dx20"h	<b>\$238.86</b>
G7616226	20"wx8"dx20"h	<b>\$284.56</b>
G7586686	20"wx8"dx24"h	<b>\$393.70</b>
G7511095	24"wx8"dx24"h	<b>\$361.21</b>
G7552273	24"wx8"dx30"h	<b>\$422.26</b>
G7541387	24"wx12"dx36"h	<b>\$791.75</b>

**BOX ENCLOSURES  
Aluminum Enclosures**

- NEMA 4

**Silver**

② #	dimensions	price
G1441736	4.27"wx1.77"dx3.16"h	<b>\$16.59</b>
G1141691	4.27"wx1.77"dx6.3"h	<b>\$28.29</b>

**Black**

② #	dimensions	price
G2968901	4.27"wx1.77"dx3.16"h	<b>\$14.00</b>
G2342627	4.27"wx1.77"dx6.3"h	<b>\$22.46</b>

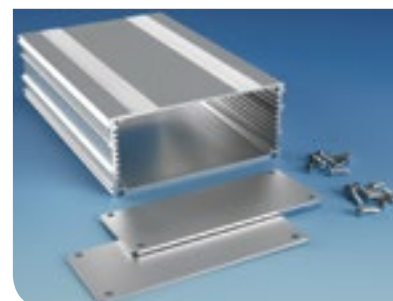



# ELECTRICAL

MORE THAN 800,000 ITEMS ONLINE

## SCHNEIDER ELECTRIC Illuminated Push Button Operators

- 30 mm
- LED
- CE



Z#	action	type	color	price
	<i>maintained 2 position push/pull</i>			
G6342463*	<i>push/pull</i>	<i>mushroom</i>	<i>green</i>	<b>\$221.85</b>
G6354345*	<i>momentary</i>	<i>full guard</i>	<i>red</i>	<b>\$136.00</b>

## SCHNEIDER ELECTRIC Illuminated Push Buttons

- 22 mm
- Momentary
- Guarded
- 1 NO/1 NC
- 10 A @ 600 VAC

Z#	color
G1279397	<i>white</i>
G0738561	<i>red</i>
G3458192	<i>green</i>

each **\$55.71**

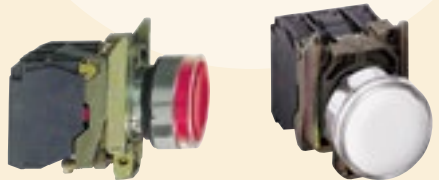

## SCHNEIDER ELECTRIC Nonilluminated Push Button Operators

- 30 mm
- UL, CSA

Z#	action	color	price
G1721474	<i>momentary</i>	<i>green</i>	<b>\$40.34</b>
G2851283	<i>push/pull</i>	<i>black</i>	<b>\$92.90</b>



## GENERAL ELECTRIC Nonilluminated Push Button Operators

- 22 mm
- UL, CSA

Z#	action	type	color	price
G2080461	<i>momentary</i>	<i>guarded</i>	<i>green</i>	<b>\$9.30</b>
G0506423	<i>push/pull</i>	<i>mushroom</i>	<i>red</i>	<b>\$22.42</b>

## SCHNEIDER ELECTRIC Illuminated Push Button Operators

- 22 mm
- LED
- UL, CSA, CE, ROHS

Z#	action	type	color	price
G4624706	<i>maintained 2 position push/pull</i>	<i>mushroom</i>	<i>red</i>	<b>\$30.82</b>
G6980565	<i>maintained push/pull</i>	<i>mushroom</i>	<i>blue</i>	<b>\$36.42</b>
G1858552	<i>maintained</i>	<i>flush button</i>	<i>green</i>	<b>\$20.32</b>
G3508881	<i>momentary</i>	<i>flush button</i>	<i>green</i>	<b>\$13.09</b>



## SIEMENS Nonilluminated Push Buttons

- 30 mm
- Momentary action
- Guarded
- 10 A @ 600 VAC
- UL, CSA

Z#	contact	color	price
G6369106*	<i>1 NC</i>	<i>black</i>	<b>\$47.84</b>
G6374776*	<i>1 NC</i>	<i>red</i>	<b>\$38.90</b>
G6374767*	<i>1 NO</i>	<i>black</i>	<b>\$26.89</b>
G6369115*	<i>1 NO</i>	<i>red</i>	<b>\$34.49</b>



## SCHNEIDER ELECTRIC Nonilluminated Push Buttons

- 22mm
- Momentary action
- Guarded
- 1 NO
- 10A @ 600 VAC

Z#	color
G2942545	<i>green</i>
G2754184	<i>black</i>
G1430475	<i>yellow</i>

each **\$23.88**



## SCHNEIDER ELECTRIC Nonilluminated Push Button Operators

- 22 mm
- Mushroom
- Red
- UL, CSA, CE, ROHS

Z#	action	price
G1588167	<i>momentary</i>	<b>\$14.63</b>
G2918921	<i>push/pull</i>	<b>\$45.23</b>



## GENERAL ELECTRIC Emergency Stop Push Button

- 33 mm mushroom
- Momentary action
- 1 NC
- Screw clamp connection
- 10A @ 600 VAC/VDC

Z#	price
G2608977	<b>\$109.57</b>



## SIEMENS Pilot Lights

- 30 mm
- Transformer
- LED
- 120 VAC
- UL, CSA

Z#	color
G1328153	<i>amber</i>
G2281596	<i>red</i>
G2584671	<i>green</i>

each **\$104.19**



## SIEMENS Pilot Lights

- 22mm
- Full voltage lamp module
- 24 VAC/VDC
- UL, CSA, CE

Z#	color	price
G0293307	<i>red</i>	<b>\$29.88</b>
G0573666	<i>green</i>	<b>\$41.09</b>
G2683746	<i>yellow</i>	<b>\$28.88</b>



## SCHNEIDER ELECTRIC Joystick Switches

- 30 mm
- 5 direction
- 2NO/2NC
- 10A @ 600 VAC
- UL, CSA, CE

Z#	contact rating	action	price
G6430776*	<i>10A @ 600 VAC</i>	<i>maintained</i>	<b>\$332.75</b>
G6507645*	<i>10A @ 250 VAC</i>	<i>momentary</i>	<b>\$344.50</b>



**HUBBELL WIRING DEVICE-KELLEMS  
Pendant Push Button Stations**

- 2 operators
- Momentary action
- NEMA 4X
- Yellow housing
- 9.13" Height
- ■ UL, CSA STANDARDS



Q#	legend	contact
G2927696	up/down	2 NO
G0278713	start/stop	1 NO/1 NC

each **\$90.08**

**SCHNEIDER ELECTRIC  
Push Button Contact Blocks**

- 22 mm
- For use with chrome or plastic operators
- 10 A @ 600 VAC
- Screw/clamp terminal
- ■ CU, CSA STANDARDS



Q#	contact
G1607602	1 NO slow break
G0977611	1 NC slow break

each **\$8.16**

**APM HEXSEAL  
Toggle Switch Boot**

- 15/32-32 NS
- .219" ID
- Gray rubber
- 7/8" height



Q#	price
G0711085	<b>\$3.78</b>

**CARLING TECHNOLOGIES  
Toggle Switches**

Q#	contact	connections	action	terminal	price
G2195715	SPST	2	on/off	screw	<b>\$3.30</b>
G4230484	SPST	2	on/off	¼" tab	<b>\$5.10</b>
G2945171	SPDT	3	momentary	screw	<b>\$6.74</b>
G3974616	SPST	3	on/off	¼" tab	<b>\$9.63</b>
G1588553	SPDT	3	on/off/on	¼" tab	<b>\$4.22</b>
G1925822	DPST	4	on/off	screw	<b>\$9.37</b>
G2085072	DPDT	6	on/off/on	¼" tab	<b>\$4.84</b>

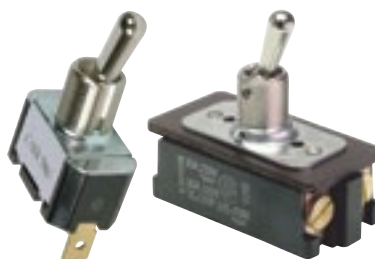

**LEVITON  
Inline Rocker Switch**

- SPST
- 2 connections
- On/off
- Screw terminal



Q#	price
G0439512	<b>\$2.25</b>

**LINEMASTER  
Foot Switch Guard**

- 6" w x 4" d x 6" h
- Steel
- Use with general purpose and light duty foot switches



Q#	price
G2115714	<b>\$24.85</b>

**POWER FIRST  
Rocker Switches**

- ¼" quick connect tab terminal
- ■ UL, CUL, TUV, CE

Q#	lighted	contact	connections	action	price
G0928611	no	SPST	2	on/off	<b>\$3.27</b>
G3237421	no	DPST	4	on/off	<b>\$4.54</b>
G0489352	no	SPDT	3	momentary	<b>\$5.30</b>
G0712923	yes	SPST	3	on/off	<b>\$1.20</b>



**SQUARE D  
Limit Switches**

- Rotary actuator
- Screw terminal connection
- ½"-14 NPT conduit wiring entry
- 600VAC/VDC
- 10 A



Q#	contact	movement	price
G0593092	1 NO/1 NC	CW/CCW	<b>\$99.84</b>
G0977252	2 NO/2 NC	CW/CCW	<b>\$114.12</b>
G1939743	2 NO/2 NC	CW/CCW, neutral	<b>\$138.73</b>
G2525722	1 NO/1 NC	CW/CCW, low torque	<b>\$185.42</b>

**CARLING TECHNOLOGIES  
Rocker Switches**

- ¼" tab terminal
- ■ UL RECOGNIZED, CSA CERTIFIED

Q#	lighted	contact	connections	action	price
G3103694	no	SPST	2	on/off	<b>\$1.12</b>
G3916351	no	SPST	2	on/off	<b>\$4.06</b>
G3481082	no	DPST	4	on/off	<b>\$4.20</b>
G3896216	yes	SPST	3	on/off	<b>\$6.71</b>
G4222066	yes	SPDT	4	on/off/on	<b>\$7.71</b>
G4219747	yes	DPDT	7	on/off/on	<b>\$9.69</b>



**OMRON  
Limit Switches**

- SPDT
- G1/2 conduit wiring entry
- Screw terminal connection
- 480VAC/250VDC
- 15A
- ■ UL, CSA

Q#	actuator	price
G1899037	wobble stick	<b>\$26.45</b>
G2468042	plunger	<b>\$19.77</b>
G1873006	rotary lever arm	<b>\$22.63</b>



**LINEMASTER  
Momentary Foot Switches**

- 120/250 VAC

Q#	contact	VAC	duty	NEMA	price
G4329035	SPDT	125/250	light	1	<b>\$13.34</b>
G4328721	SPDT	125/250	general purpose	1	<b>\$23.00</b>
G3369247	SPDT	125/250	heavy	2,4,13	<b>\$76.72</b>
G0525734	DPDT	125/250	heavy	2,4,13	<b>\$119.50</b>





# ELECTRICAL

MORE THAN 800,000 ITEMS ONLINE

## CARLING TECHNOLOGIES Miniature Push Button Switches

- 125VAC
- SPST
- 2 connections
- Off/momentary on
- For shallow back panels



Z#	terminal	price
G2435727	screw	<b>\$7.16</b>
G4290937	wire lead	<b>\$5.78</b>

## OMRON Snap Switches

- SPDT
- 125/250/480 VAC
- Screw terminal

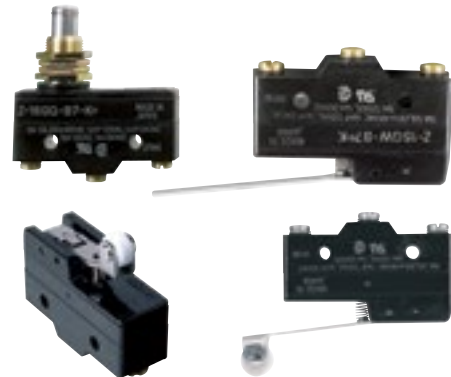

Z#	amperage	actuator	price
G2025301	15 A	hinge lever	<b>\$7.97</b>
G2301923	15 A	panel mount plunger	<b>\$9.07</b>
G0895903	15 A	hinge roller lever	<b>\$5.17</b>
G1328031	15 A	short hinge roller lever	<b>\$4.82</b>
G0552377	20 A	panel mount plunger	<b>\$11.80</b>

## CARLING TECHNOLOGIES Rotary Switches

- 125VAC
- CUL, CSA



Z#	contact	connections	action	terminal	price
G1126885	SPST	2	on/off	6" wire lead	<b>\$3.30</b>
G1361394	SP3T	4	off/on/on/on	solder lug	<b>\$5.69</b>

## POWER FIRST Miniature Push Button Switch

- SPST
- 2 connections
- Off/momentary on
- Screw terminal
- UL



Z#	price
G1190077	<b>\$9.25</b>

## HONEYWELL Miniature Snap Switches

### Pin Plunger Actuator

- Quick connect terminal
- SPDT
- 3A
- 250 VAC



Z#	price
G4708681	<b>\$2.28</b>

### Long Straight Lever Actuator

- Quick connect terminal
- SPST-NC
- 15A
- 277 VAC



Z#	price
G4734536	<b>\$3.03</b>

## SQUARE D Pressure Switches

- Diaphragm actuation
- DPST
- Series 9013FHG



Z#	application	psi	port type	price
G1089514	air and water	20 to 100	¼" FNPS	<b>\$14.58</b>
G2329117	air compressor	40 to 150	¼" FNPS	<b>\$27.12</b>
G0257984	air compressor	60 to 200	¼" MNPT	<b>\$29.12</b>
G1827305	air compressor	60 to 200	¼" FNPS	<b>\$38.82</b>

### Replacement Contact Kit

Z#	price
G2172545	<b>\$8.05</b>

## HONEYWELL MICRO SWITCH Snap Switches

- SPDT
- 125/250/480 VAC
- Screw terminal
- UL, CSA



Z#	amperage	actuator	price
G1881451	15 A	overtravel plunger	<b>\$9.59</b>
G3499307	15 A	roller Lever	<b>\$8.45</b>
G1893071	25 A	overtravel plunger	<b>\$17.09</b>

## SQUARE D Air Conditioning Disconnect Switches

- Nonfusible
- 60 A
- 240 VAC/VDC
- 1-phase
- 10 Hp @ 240 VAC



Z#	material	caps	price
G1952517	metallic	3R	<b>\$12.61</b>
G3273934	non-metallic	3	<b>\$18.08</b>



## CONDOR USA, INC Pressure Switches

- For air compressors
- 25 to 160 psi
- Diaphragm actuation
- DPST
- UL, CSA

Z#	port type	price
G0333137	1-port ¼" FNPT	<b>\$24.10</b>
G2509297	4-port ¼" FNPT	<b>\$26.14</b>

## SQUARE D Drum Reversing Switch

- Maintained/momentary reversing
- 1½ HP @ 1 phase — 115 V
- UL/CSA STANDARDS



Z#	price
G1465326	<b>\$101.26</b>

## DAYTON Drum Reversing Switches

- Maintained/reversing
- 1½ HP @ 1 phase — 115V



Z#	phase	price
G0754241	single	<b>\$53.83</b>
G3423901	multi	<b>\$61.09</b>

### LEVITON Disconnect Switches

- Nonfusible
- 600 VAC
- 2PST
- ■ UL, ANSI, NOM



Q #	amperage	phase	hp	price
G1612256	30 A	3	3 to 20 @ 600 V	<b>\$38.89</b>
G1930047	40 A	1	2 to 15 @ 600 V	<b>\$42.21</b>

### LEVITON Wall Switches

- 120 to 277 VAC
- ■ UL, CSA, NOM

Q #	amperage	action	grade	color	price
G1376934	20 A	maintained	commercial	white	<b>\$1.78</b>
G2899662	30 A	maintained	industrial	ivory	<b>\$12.43</b>
G1162122	30 A	maintained	industrial	brown	<b>\$11.05</b>
G2103412	15 A	momentary, 3 position center off	industrial	white	<b>\$22.87</b>



### LEVITON Locking Wall Switches

- Maintained
- 120 to 277 VAC
- 1-pole
- Brown
- ■ UL, CSA, NOM



Q #	amperage	price
G2407203	15 A	<b>\$10.01</b>
G1560641	20 A	<b>\$9.68</b>

#### Switch Key

Q #	price
G0804072	<b>\$2.34</b>



### IDEAL Pull Chain Lever Switch

- SPST
- 2 connections
- On/off
- Wire lead terminal

Q #	price
G3201125	<b>\$8.95</b>



### HONEYWELL Door Switches

- SPDT
- Momentary on/off
- Push rod plunger
- includes stainless steel bracket

Q #	AC contact	terminal	price
G4532963	5 A @ 250	quick connect	<b>\$62.94</b>
G4612133	15 A @ 125/250	screw	<b>\$35.23</b>



### LEVITON Fixture Pull Switches

- 6" lead terminal
- ■ UL, CSA



Q #	contact	connections	action	price
G1427203	SPST	2	on/off	<b>\$3.85</b>
G2394551	SP3T	3	off, 1 on, 2 on, 1 and 2 on	<b>\$3.30</b>

### DORMEYER Laundry Solenoids

- ¼" spade terminal

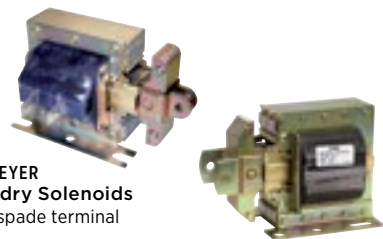

Q #	stroke	pull force	VAC	price
G3241375	¼" to 1"	96 to 128 oz	120	<b>\$19.89</b>
G1454442	¼" to 1¼"	240 to 384 oz	115	<b>\$29.15</b>

### THOMAS & BETTS Door Switch

- SPST
- 2 connections
- On when door is open
- 5 A @ 125 V
- 3 A @ 250 V

Q #	price
G2084722	<b>\$13.10</b>



### DORMEYER Laminated Solenoids

- 120 VAC
- Solder lug coil terminal

Q #	stroke	pull force	price
G0528272	⅜" to ¾"	14.4 to 48 oz	<b>\$16.76</b>
G1062792	⅜" to 1"	64 to 128 oz	<b>\$24.24</b>
G2504686	⅜" to 1"	92.8 to 176 oz	<b>\$36.59</b>
G2959004	⅜" to 1¼"	192 to 256 oz	<b>\$33.53</b>

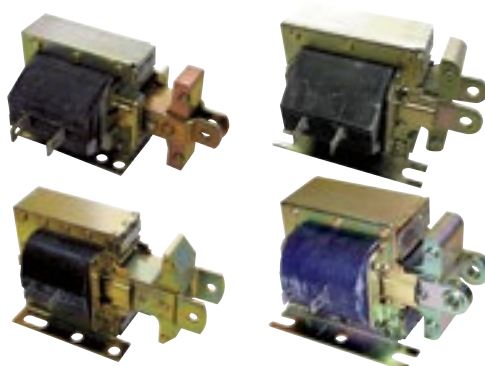

### WHITE-RODGERS DC Power Solenoids

- Isolated coil
- SPNO

Q #	VDC coil	amperage	contact material	price
G1031852	12	80 A	copper	<b>\$36.04</b>
G1702102	12	100/50 A	silver alloy	<b>\$38.18</b>
G1919443	24	50 A	copper	<b>\$30.13</b>
G1238045	24	200/100 A	silver alloy	<b>\$61.45</b>
G2774143	36	50 A	copper	<b>\$31.19</b>
G1971742	36	200/100 A	silver alloy	<b>\$59.89</b>





# ELECTRICAL

MORE THAN 800,000 ITEMS ONLINE

## DAYTON Surface-Mount On Delay Relay

- 2 pins
- 1NO
- 24 to 240VAC/12 to 48VDC
- 1 A
- 3 to 60 sec

Z#	price
G0567987	<b>\$28.43</b>



## DAYTON Multi Function Octal Base Relay

- 11 pins
- DPDT
- 120 VAC/DC
- 10 A
- .05 to 999 hr

Z#	price
G0730231	<b>\$102.80</b>



## OMRON Enclosed Flange Mount Relays

- 6 pins
- 25 A @ 220 VAC
- DPST-NO
- UL, CSA, TUV



Z#	voltage	terminal	price
G0783273	24 VDC	screw	<b>\$11.64</b>
G1498691	24 VAC	¼" tab	<b>\$7.59</b>

## OMRON Time Delay Octal Base Relays

- Plug in or panel mount
- UR, CSR, CE

Z#	pins	contact	VAC/VDC	amperage	price
G1524047	11	SPDT	24 to 240/12 to 240	3 A	<b>\$71.65</b>
G0778687	8	DPDT	120	5 A	<b>\$88.90</b>



## MAGNECRAFT Power Relays

- Din rail or bottom flange
- ¼" tab terminal

Z#	pins	contact	amperage @ VAC	voltage	price
G2290127	6	DPST-NO	30 @ 277	120 VAC	<b>\$7.97</b>
G3131021	8	DPDT	3 @ 277 (NO); 3 @ 277 (NC)	12 VDC	<b>\$8.38</b>
G3266794	8	DPDT	3 @ 277 (NO); 3 @ 277 (NC)	120 VAC	<b>\$10.12</b>
G2055042	8	DPDT	3 @ 277 (NO); 3 @ 277 (NC)	24 VAC	<b>\$9.12</b>



## DAYTON Relay Socket

- DIN rail/ccrew mount
- Octal
- 8 pins
- 300 V
- 15 A @ 300V, 10 A @ 600 V

Z#	price
G1753902	<b>\$4.98</b>



## MAGNECRAFT Relay Sockets

- DIN rail/panel mount

Z#	shape	pins	VAC	amperage ac	price
G1335993	octal	8	300/600	15/10 A	<b>\$2.65</b>
G1367527	octal	11	300/600	15/5 A	<b>\$4.27</b>
G1656015	square	8	300	10 A	<b>\$4.08</b>
G2708842	square	11	300	15 A	<b>\$4.39</b>

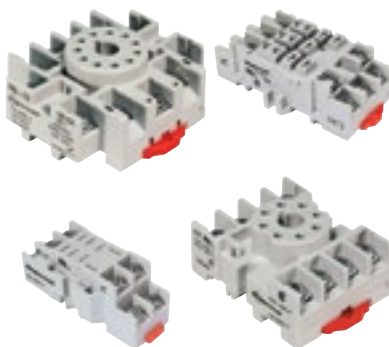

## INTERMATIC Locking Photocontrol

- 120 to 277 VAC
- 1000 to 2300 max wattage
- Polypropylene
- Dusk to dawn
- UL, CSA

Z#	price
G0852661	<b>\$8.93</b>



## INTERMATIC Threaded Photocontrols

- ½" male pipe thread
- Polycarbonate housing
- Dusk to dawn

Z#	VAC	max wattage	swivel	amperage	price
G1511693	120	1800	no	15 A	<b>\$8.32</b>
G2958164	120	1800	yes	15 A	<b>\$8.27</b>
G2209523	120	3000	yes	25 A	<b>\$12.43</b>
G2790164	120 to 277	1800 to 4150	yes	15 A	<b>\$13.79</b>



## INTERMATIC Fixed Photocontrols

- Polycarbonate housing
- Dusk to dawn
- UL, CSA

Z#	VAC	max wattage	price
G1898251	120	1800	<b>\$6.55</b>
G2316133	208 to 277	3100 to 4150	<b>\$9.60</b>

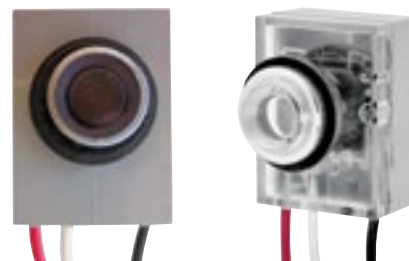

**INTERMATIC Stem Mount Swiveling Photocontrol**  
 • 208 to 277 VAC  
 • 3100 to 4150 max wattage  
 • Polycarbonate housing  
 • Dusk to dawn



#	price
G4316383	<b>\$14.44</b>

**INTERMATIC Stem Mount Photocontrol**  
 • 208 to 277 VAC  
 • 3100 to 4150 max wattage  
 • Polypropylene housing  
 • Dusk to dawn



#	price
G2788405	<b>\$9.43</b>

**TORK Conduit Mount Swiveling Photocontrols**  
 • 180 degrees swivel  
 • 120 VAC  
 • 2000 max wattage  
 • Lexan  
 • Dusk to dawn



#	description	price
G1795044	translucent dome	<b>\$10.36</b>
G2072682	waterproof	<b>\$10.32</b>

**INTERMATIC Photocontrol Receptacle**  
 • Use with Intermatic photocontrols  
 includes bracket



#	price
G4297334	<b>\$6.90</b>

**INTERMATIC Photocontrol Shorting Cap**  
 • Use with Intermatic photocontrols



#	price
G4297361	<b>\$3.95</b>

**TORK Turn-Lock Photocontrols**  
 • 3600 max wattage  
 • DPST  
 • Dusk to dawn  
 • 277 VAC  
 • 360° adjustable



#	price
G2262766	<b>\$120.73</b>

**TORK Flush Mount Photocontrols**  
 • 120 VAC  
 • 2000 max wattage  
 • Dusk to dawn



#	material	price
G3163727	lexan	<b>\$6.83</b>
G1188862	aluminum	<b>\$9.30</b>

**ACUITY LITHONIA Photocontrol Buttons**  
 • LED  
 • Polycarbonate



#	VAC	color	price
G6064222	120 to 277	green	<b>\$27.97</b>
G6178085	480	yellow	<b>\$30.91</b>

**INTERMATIC 7-Day Electromechanical Timers**  
 • 4PST-NO  
 • 125 V  
 • 40 A  
 • Extra trippers: G4298996  
 includes (14) trippers



#	price
G3030842	<b>\$88.19</b>

**INTERMATIC 24-Hour Electromechanical Timers**  
 • 40 A  
 includes (2) trippers

**Steel Enclosure**

#	contact	voltage	dimensions	extra trippers	price
G1814854	SPST-NO	120	5" wx 3" dx 7.8" h	G2238957	<b>\$46.00</b>
G2547036	DPST-NO	120	5" wx 3" dx 7.8" h	G2238957	<b>\$40.85</b>
G0428382	DPST-NO	208-277	5" wx 3" dx 7.8" h	G2238957	<b>\$38.47</b>
G2848361	DPST-NO	208-277	5.5" wx 3.6" dx 9.4" h	G2238957	<b>\$54.47</b>
G2275323	SPST-NO	125	5.5" wx 3.6" dx 9.4" h	G2238957	<b>\$49.89</b>
G0346604	4PST-NO	120	5.5" wx 3.6" dx 9.4" h	G3966121	<b>\$79.95</b>

**Plastic Enclosure**

#	contact	voltage	dimensions	extra trippers	price
G2997181	DPST-NO	208-277	5.5" wx 3.8" dx 9.4" h	G2238957	<b>\$66.19</b>
G1025324	DPST-NO	120	5.5" wx 3.8" dx 9.4" h	G2238957	<b>\$62.52</b>



**INTERMATIC Timer Replacement Parts**  
 • For use with Intermatic timers

**Trippers**

#	mfr. no.	pack	price
G2238957	156T1961A	2	<b>\$1.42</b>
G3966121	156T1948A	2	<b>\$3.55</b>
G0393671	156T2978A	12	<b>\$2.38</b>



**Motors**

#	mfr. no.	price
G0271616	WG1573	<b>\$14.24</b>
G2612346	WG1570	<b>\$16.46</b>
G0623664	WG733	<b>\$17.35</b>
G2107996	WG730	<b>\$15.71</b>



**Dial Mechanisms**

#	mfr. no.	price
G2337973	T104M	<b>\$45.89</b>
G2695953	T101M	<b>\$41.78</b>
G0770314	T103M	<b>\$54.44</b>



**eZTIPS**  
 technical resources

eZTips about timer motors are available online at [zoro.com/eztips](http://zoro.com/eztips)



# ELECTRICAL

MORE THAN 800,000 ITEMS ONLINE

## INTERMATIC Mechanical Water Heater Timers

- DPST
  - Steel enclosure
  - 5" w x 3" d x 7.75" h
  - Extra trippers: G2238957
- includes (2) trippers

Z#	voltage	price
G1311536	240	<b>\$37.82</b>
G1337341	208-240	<b>\$54.66</b>



## INTERMATIC Digital Water Heater Timer

- DPST
- Steel enclosure
- 240 V
- 30 A
- 5" w x 3" d x 7.75" h

Z#	price
G0632073	<b>\$66.37</b>



## INTERMATIC Spring Wound Timers

- SPST
- Single gang box
- Plastic knob



Z#	range	hold feature	color	price
G1916467	0 to 5 min	no	silver	<b>\$15.68</b>
G0716107	0 to 15 min	no	silver	<b>\$19.73</b>
G4992976	0 to 15 min	no	white	<b>\$16.26</b>
G3392645	0 to 30 min	no	silver	<b>\$16.45</b>
G4992197	0 to 30 min	no	white	<b>\$12.52</b>
G5039535	0 to 60 min	no	white	<b>\$11.92</b>
G2484973	0 to 60 min	no	silver	<b>\$15.24</b>
G4993046	0 to 60 min	yes	white	<b>\$17.18</b>
G2080486	0 to 60 min	yes	silver	<b>\$14.92</b>
G1281147	0 to 2 hr	no	silver	<b>\$25.12</b>
G1374773	0 to 4 hr	no	silver	<b>\$23.43</b>
G2940235	0 to 6 hr	no	silver	<b>\$24.19</b>
G2350171	0 to 12 hr	yes	silver	<b>\$28.75</b>
G1256622	0 to 12 hr	no	silver	<b>\$18.86</b>
G4993073	0 to 12 hr	yes	white	<b>\$26.87</b>

## INTERMATIC 7 Day Astronomic Timers

- 1 channel
- 120/208 to 240/277 VAC
- Steel enclosure



Z#	contact	amperage	cycles	price
G0513755	SPST	30 A	14 max	<b>\$123.74</b>
G1041957	SPDT	20/20/5A	56 max	<b>\$149.04</b>

## TORK Plug-In Digital Timer

- 120 V
- 15 A
- 1 receptacle
- 1 min to 7 days

Z#	price
G3658015	<b>\$12.04</b>



## LEVITON Indoor Lamp/Appliance Timers

- Digital
- 120 V
- 15 A
- 1 receptacle
- 1 min to 7 days
- UL, NOM

Z#	price
G3689691	<b>\$16.76</b>



## TORK Programmable Electronic Timers

- 1 channel
- SPST
- 120-277 V
- 40 A
- Plastic enclosure
- cULus LISTED



Z#	range	price
G0759936	1 min to 24 hr	<b>\$59.77</b>
G3268727	1 min to 7 day	<b>\$130.57</b>

## INTERMATIC Electronic Timer

- 2 channels
- SPST
- 120/208/240/277 V
- 30 A
- 1 min to 24 hr

Z#	price
G2299473	<b>\$99.25</b>



## TORK Indoor Lamp/Appliance Timers

- Mechanical
- 120 V
- 15 A
- 15 min to 24 hr

Z#	receptacles	cycles/day	price
G4206745	1	2	<b>\$5.95</b>
G0998864	2	48	<b>\$10.50</b>



## TORK Astronomic/Programmable Electronic Timers

- 120-277 V
- Plastic enclosure
- cULus LISTED

Z#	channels	contact	amperage	range	price
G2179265	1	DPST	40 A	1 min to 24 hr/7 days	<b>\$139.16</b>
G2802371	2	SPDT	30 A	1 min to 365 days	<b>\$298.65</b>



## INTERMATIC Cycle Timer

- SPDT
- 125 V
- 20 A
- 15 sec to 30 min

Z#	price
G2505492	<b>\$49.17</b>





**OMRON**  
**Digital Timers**

- 2 channels
- SPST-NO
- 100-240 VAC
- 15 A

Q#	range	mount	price
G4308096	1 min to 24 hr	panel/track	<b>\$169.74</b>
G4308105	1 min to 7 days	flush	<b>\$167.18</b>



**TORK**  
**Plug-In Mechanical Timers**

- 125 V
- 15 A
- 15 min to 23¼ hr
- 1 receptacle



Q#	color	price
G2087425	white	<b>\$6.94</b>
G3250283	gray	<b>\$10.58</b>

**PARAGON**  
**Defrost Timer**

- Universal
- 1 SPDT, 1 SPST
- 120/208/240 V
- 30 A



Q#	price
G0267741	<b>\$104.80</b>

**REDINGTON**  
**Hour Meters**

- Black plastic
- Screw mount
- Spade terminal



**AC Quartz**

Q#	face	VAC	price
G1427885	2-hole rectangular	90 to 264	<b>\$12.22</b>
G3482464	3-hole round	90 to 264	<b>\$12.23</b>

**DC Quartz**

Q#	face	VDC	price
G1689721	2-hole rectangular	10 to 80	<b>\$12.22</b>
G3184842	3-hole round	10 to 80	<b>\$12.23</b>

**DIEHL**  
**Interval Timer**

- SPST
- 120 VAC
- 1 sec to 99 hr 59 min



Q#	price
G1290615	<b>\$125.83</b>

**DIEHL**  
**Electromechanical Modules**

- SPST-NO
- 120 V
- 20/15 A
- Panel mount, 2½" dia opening required



Q#	range	price
G1520802	15 min to 23¼ hr	<b>\$29.91</b>
G0428066	2 hr to 6 days, 20 hr	<b>\$34.08</b>

**INTERMATIC**  
**Wall Switch and Outlet Timer**

- 120 V
- 15 A
- 30 min to 23½ hr



Q#	price
G1692275	<b>\$33.81</b>

**ENM**  
**Hour Meters**

- 6 digits
- Black plastic
- Flange mount

Q#	type	face	VAC	price
G1464897	electrical	flush rectangular	115/230	<b>\$22.04</b>
G1946052	electrical	3-hole round	115/230	<b>\$23.09</b>
G0764881	LCD	2-hole rectangular	4.5 to 28	<b>\$30.75</b>



**MARKTIME**  
**Spring Wound Timer**

- Automatic off
- DPST
- 28 A @ 250 V
- 0 to 60 min



Q#	price
G2747114	<b>\$72.92</b>

**HOBBS**  
**Hour Meters**

- DC quartz
- 5 digits
- 10 to 80 VDC

Q#	face	mount	price
G2065655	2-hole rectangular	flange	<b>\$46.99</b>
G0814134	3-hole round	flange	<b>\$37.99</b>
G1046062	round	bracket	<b>\$39.68</b>



**ENM**  
**Counter**

- Mechanical
- 4 digits
- Hand tally
- Knob reset



Q#	price
G0250196	<b>\$11.52</b>

**INTERMATIC**  
**Swimming Pool Timers**

- DPST-NO
- 1 hr to 23 hr

Q#	type	voltage	amperage	price
G1985401	timing center	208-277	40 A	<b>\$131.04</b>
G1497842	timing/heater circuit center	208-277	40 A	<b>\$183.34</b>
G1476833	timing/control center	240	30 A	<b>\$94.70</b>





# ELECTRICAL

MORE THAN 800,000 ITEMS ONLINE

- 3M Heat Shrink Tubing Assortment**
- 30 to 1 AWG
  - 6" length
  - Flexible polyolefin
  - 2:1 shrink ratio
  - 133 pieces



Z#	price
G3186206	<b>\$60.93</b>

- 3M Heat Shrink Tubing**
- 6" length
  - Flexible polyolefin
  - 2:1 shrink ratio
  - UL, CSA



Z#	wire	pack	price
G1721876	16 to 12 AWG	21	<b>\$12.55</b>
G2479671	20 to 18 AWG	21	<b>\$11.01</b>

- SOUTHWIRE COMPANY Building Wire**
- THHN
  - 12 AWG
  - 600 VAC, 20 A
  - Stranded
  - Nylon jacket



Z#	length	color	price
G0209176	100'	green	<b>\$31.50</b>
G0209115	500'	green	<b>\$72.54</b>
G0209081	500'	white	<b>\$71.97</b>

- VALUE BRAND HDMI Cable**
- Male to male
  - PVC jacket
  - For AV equipment
  - UL/CSA, ROHS COMPLIANT



Z#	length	price
G0883547	3'	<b>\$5.99</b>
G2481823	10'	<b>\$10.66</b>

- KLEIN TOOLS Insulated Wire Stripper/Cutter**
- 18 to 10 AWG
  - Solid cable
  - Manual adjustment
  - Spring return
  - 6 1/4" length



Z#	price
G2891043	<b>\$10.99</b>

- TECHFLEX Sleeving**
- Expandable braided
  - Black
  - Polyethylene
  - [▶ MORE SIZES ONLINE](#)



Z#	cord diameter	id	length	price
G1523943	.09" to .25"	.125"	100'	<b>\$13.27</b>
G0695931	.12" to .44"	.25"	10'	<b>\$2.40</b>
G2787057	.12" to .44"	.25"	100'	<b>\$15.92</b>
G0802681	.18" to .63"	.375"	50'	<b>\$11.59</b>
G0779037	.25" to .75"	.5"	50'	<b>\$16.59</b>
G1250155	.5" to 1.25"	.75"	10'	<b>\$5.98</b>

- POWER FIRST Heat Shrink Tubing**
- 6" length
  - Polyolefin

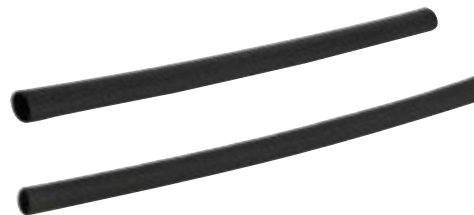

Z#	wire	shrink ratio	pack	price
G0647035	16 to 12 AWG	3:1	20	<b>\$35.82</b>
G0821895	20 to 18 AWG	2:1	30	<b>\$11.47</b>

- 3M Heat Shrink Breakout Boots**
- 2.7" length
  - 1000 max voltage
  - Black
  - Polyolefin



Z#	outlet	ID before shrinking	price
G0920805	2 way	0.8"	<b>\$11.06</b>
G3074303	3 way	0.9"	<b>\$13.07</b>

- THOMAS & BETTS Heat Shrink Tubing**
- 6" length
  - Polyolefin



Z#	wire	shrink ratio	pack	price
G2322591	6 to 1 AWG	2:1	10	<b>\$2.22</b>
G0712783	8 to 6 AWG	3:1	25	<b>\$38.08</b>

- INSULTAB Heat Shrink Tubing Dispenser Spool**
- 1/16", 1/8", 3/16", 1/4", 3/8" ID before shrinking
  - 100, 25, 25, 25, 25 ft lengths
  - Flexible PVC
  - 2:1 shrink ratio
  - 600 V max



Z#	price
G0729915	<b>\$129.12</b>

- VALUE BRAND Conversion Cable**
- Black



Z#	converts	connections	price
G1342993	S-v ideo & 3.5 mm male to 3 RCA male	for vcr, dvd	<b>\$5.60</b>
G4474662	VGA signal to RCA/S-video	for computer to tv	<b>\$3.00</b>

- POWER FIRST Power Supply Cord**
- Bare end



Z#	gauge	NEMA	length	voltage	jacket	price
G1165482	14/3	6-15P	8'	250	rubber	<b>\$13.61</b>
G2423407	16/3	5-15P	8'	125	PVC	<b>\$17.88</b>
G1771305	14/3	5-15P	10'	125	PVC	<b>\$28.55</b>
G0418862	16/2	1-15P	10'	125	PVC	<b>\$19.08</b>
G3044982	16/3	5-15P	10'	125	PVC	<b>\$22.15</b>

**FREE UPS Ground shipping on orders of \$50 or more\***

\$ prices subject to change

**VALUE BRAND Cable Splitter**

- 3 RCA male to 2 sets of 3 RCA female
- RG-59
- Black



Q#	price
G0345423	<b>\$7.22</b>



**ANDERSON POWER PRODUCTS Wire Connectors**

- Two-pole
- Gray polycarbonate

Q#	wire	amperage	max wire dia	price
G2642351	6 AWG	50 A	.221"	<b>\$3.84</b>
G0333453	4 AWG	120 A	.298"	<b>\$8.73</b>

**CABLOFIL Cable Tray And Accessories**

- Zinc plated steel

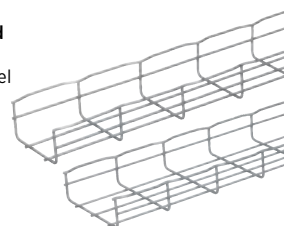

- Tray**
- 6.5' length
  - 4 pack

Q#	width	price
G2679381	4"	<b>\$240.67</b>
G1943295	6"	<b>\$243.35</b>

**Support Bracket**

Q#	price
G3053233	<b>\$10.10</b>



**3M Cable Ties**

- Nylon
- 100 pack



Q#	length	max bundle dia	tensile strength	color	price
G1929191	11"	3"	50 lbs	natural	<b>\$3.06</b>
G1722034	11"	3"	50 lbs	black	<b>\$5.48</b>
G1039193	15"	4"	120 lbs	natural	<b>\$15.74</b>



**THOMAS & BETTS Cable Tie Mounting Pads**

- 4-way
- Rubber adhesive
- 100 pack

Q#	size	slot width	price
G1731414	1.13" x 1.13"	.205"	<b>\$9.99</b>
G1177486	.75" x .75"	.16"	<b>\$10.98</b>



**Center Support**

Q#	price
G2258925	<b>\$12.72</b>



**VALUE BRAND Cable Tie Mounting Pads**

- 4-way
- .75" x .75"
- .3" slot width
- Nylon 6/6 with acrylic adhesive
- 100 pack



Q#	price
G1337917	<b>\$3.67</b>



**PANDUIT Cable Clamps**

- Screw mount
- Nylon 6/6
- 100 pack

Q#	max bundle dia	price
G2582106	.25"	<b>\$14.58</b>
G0831171	.5"	<b>\$16.11</b>

**Clamp Washers**

- 50 pack

Q#	price
G1297256	<b>\$38.24</b>

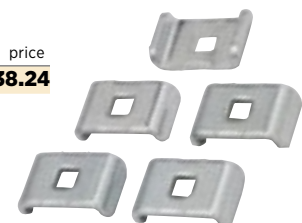

**Guide**

Q#	price
G2792237	<b>\$6.81</b>



**CADDY Cable Supports**

- Screw on 1/8" to 1/2" flange
- Galvanized steel
- 3/4" max capacity
- 48 lb max capacity
- 5 pack



Q#	price
G2891472	<b>\$5.62</b>

**THOMAS & BETTS Cable Tie Mounting Cradle**

- 2-way
- 1 1/4" x 1"
- .3" slot width
- Nylon 6/6 with rubber adhesive
- 100 pack



Q#	price
G0702405	<b>\$13.83</b>

**VALUE BRAND Cable Clips**

- Adhesive mount
- 1" x 1"
- Nylon 6/6
- 25 pack



Q#	price
G1293607	<b>\$4.53</b>



# ELECTRICAL

MORE THAN 800,000 ITEMS ONLINE

### IGUS Cable Carriers

- Zipper style
- 7.28"/185 mm loop length
- 1.5"/38 mm bend radius



#### Carriers

Z#	cavity width	length	price
G1374746	.59"/15 mm	3'	<b>\$58.11</b>
G0258282	1.50"/38 mm	3'	<b>\$56.07</b>

#### Mounting Brackets

Z#	cavity width	price
G2817087	.59"/15mm	<b>\$10.68</b>
G0887171	1.50"/38mm	<b>\$11.43</b>



### HUBBELL WIRING DEVICE-KELLEMS Cable Covers

- PVC

Z#	dimensions	max cable dia	color	price
G1923171	2.75" x 10'	.31"	brown	<b>\$15.93</b>
G2947935	2.75" x 10'	.31"	black	<b>\$15.93</b>
G0716791	2.75" x 10'	.31"	beige	<b>\$15.93</b>
G1326087	3" x 5' l	.5"	brown	<b>\$12.27</b>
G2294135	3" x 5' l	.5"	black	<b>\$12.27</b>
G2635157	3" x 5' l	.5"	beige	<b>\$12.27</b>

### LEGRAND Plastic Raceway

- 1 channel
- Snap on
- Adhesive mount
- Ivory
- UL, CSA



Z#	series	dimensions	price
G2397385	400	3/8" w x 1/2" h x 60" l	<b>\$8.36</b>
G0605561	2300	2 3/4" w x 1 1/2" h x 60" l	<b>\$20.80</b>

### 3M Female Disconnect

- 12 to 10 AWG
- Nylon insulation
- Tin-plated copper connection
- 50 pack



Z#	price
G0810957	<b>\$26.88</b>

### IDEAL Wire Connectors

- Twist-on

Z#	series	wire combination	max voltage	color	pack	price
G2762182	71B	min 2 #22 (standard) - max 2 #16	300	gray	100	<b>\$6.76</b>
G3451192	72B	min 2 #22 - max 3 #16	300	blue	100	<b>\$5.06</b>
G1526305	73B	min 1 #18 & 1 #20 - max 2 #14	600	orange	100	<b>\$7.66</b>
G0892071	73B	min 1 #18 & 1 #20 - max 2 #14	600	orange	300	<b>\$16.92</b>
G2930356	74B	min 2 #18 - max 4 #14 & 1 #18	600	yellow	100	<b>\$9.99</b>
G2981842	74B	min 2 #18 - max 4 #14 & 1 #18	600	yellow	175	<b>\$10.78</b>

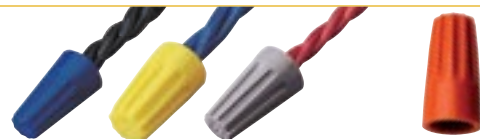

### IDEAL Wing Nut Wire Connectors

- Twist-on
- 600 max voltage
- 100 pack

#### Wire Connectors

Z#	series	wire combination	price
G3477984	451	min 2 #18 - max 3 #12	<b>\$10.69</b>
G0987542	452	min 2 #18 - max 4 #10	<b>\$9.46</b>

#### Socket Tool

- Fits 1/4" chuck or drive socket

Z#	price
G2571177	<b>\$8.20</b>



## 480 VOLTS 480 VOLTS

### BRADY Voltage Markers

- Self-stick vinyl

Z#	legend	size	markers/card
G2611025	480 volts	4 1/2" x 1 1/2"	4
G3159974	240 volts	2 1/4" x 1 1/2"	18

each **\$2.67**

### 3M Butt Splice Connectors

- 600 max voltage
- Vinyl insulation
- Copper connection
- UL, CSA

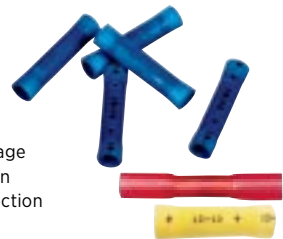

Z#	wire	color	pack	price
G2946973	22 to 18 AWG	red	100	<b>\$16.97</b>
G1913292	16 to 14 AWG	blue	100	<b>\$8.81</b>
G3250301	12 to 10 AWG	yellow	50	<b>\$9.07</b>

### 3M Wire Connectors

- 600 max voltage
- Solid and stranded wire
- 1.17" length
- UL, CSA STANDARDS

Z#	wire combination	wire	color	pack	price
G1441894	2-3	22-12 AWG	orange/blue	500	<b>\$37.41</b>
G1321047	2-5	18-12 AWG	tan/red	750	<b>\$69.45</b>



### IDEAL Aluminum-to-Copper Wire Connectors

- Series 65
- Min 2 #18 - max 4 #10
- 600 max voltage
- Purple
- 25 pack

Z#	package	price
G1040794	25	<b>\$53.09</b>



### 3M Wire Marker Dispenser

- 1 1/4" width
- Numbers 0 to 9
- 10 rolls/legend

Z#	price
G3472226	<b>\$30.45</b>



**3M Fork Terminals**

- 600 max voltage
- Vinyl insulation
- Copper connection
- ■ UL, CSA



Q #	AWG	color	stud	pack	price
G0653965	22 to 18	red	#10	100	<b>\$14.30</b>
G1792551	22 to 18	red	#8	100	<b>\$15.55</b>
G1783162	16 to 14	blue	#10	100	<b>\$14.98</b>
G2397324	16 to 14	blue	#8	100	<b>\$16.79</b>
G1690674	12 to 10	yellow	#10	50	<b>\$7.94</b>
G1656164	12 to 10	yellow	#8	50	<b>\$9.21</b>

**3M Ring Terminals**

- 600 max voltage
- Vinyl insulation
- Copper connection
- ■ UL, CSA



Q #	AWG	color	stud	pack	price
G3292021	12 to 10	yellow	#8	50	<b>\$8.70</b>
G1968321	16 to 14	blue	#10	100	<b>\$16.45</b>
G1180882	22 to 18	red	#10	100	<b>\$13.00</b>



**VALUE BRAND EMT Conduit**

- 10' length
- Galvanized steel
- ■ UL

Q #	conduit size	od	id	wall thick	price
G0518883	3/2"	4 9/16"	3 9/16"	3/16"	<b>\$2.97</b>
G2051707	3/4"	3 9/16"	3 1/2"	3/16"	<b>\$6.90</b>
G2374924	1"	1 3/16"	1 1/16"	3/16"	<b>\$11.85</b>
G2111645	1 1/4"	1 7/8"	1 5/8"	3/16"	<b>\$14.87</b>
G1435384	1 1/2"	1 7/4"	1 3/4"	3/16"	<b>\$22.17</b>
G1955274	2"	2 3/16"	2 1/16"	3/16"	<b>\$26.45</b>

**WHITE-RODGERS Transformers**

- Class 2
- 1 phase
- 24 VAC output

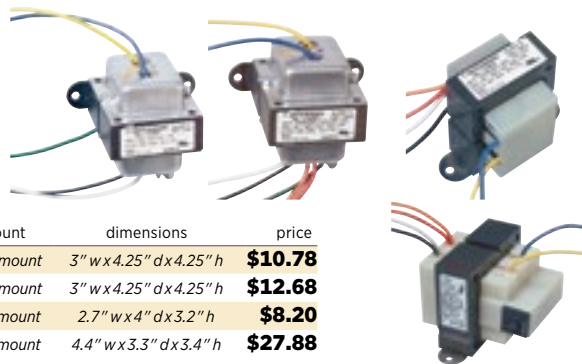

Q #	VAC input	VA rating	mount	dimensions	price
G1296741	120	40	multimount	3" w x 4.25" d x 4.25" h	<b>\$10.78</b>
G3231803	120/208/240	40	multimount	3" w x 4.25" d x 4.25" h	<b>\$12.68</b>
G1296924	120/208/240	40	foot mount	2.7" w x 4" d x 3.2" h	<b>\$8.20</b>
G1012636	120/208/240	60	foot mount	4.4" w x 3.3" d x 3.4" h	<b>\$27.88</b>

**POWER FIRST Terminal Kit**

- Insulated
- Includes 193 terminals, connectors, and crimping tool



Q #	price
G0623034	<b>\$66.52</b>

**POWER FIRST Terminal Kit**

- Noninsulated
- Includes 281 terminals, connectors, and crimping tool



Q #	price
G0524675	<b>\$73.75</b>

**THOMAS & BETTS Nylon Liquid Tight Connectors**

- For 1 cord
- Gray
- NEMA 4
- ■ UL/CSA STANDARDS



Q #	conduit size	cord dia	price
G1448212	1/2"	2 5/16" to 3 5/16"	<b>\$1.96</b>
G2446044	3/8"	3/16" to 2 5/16"	<b>\$1.93</b>

**ARLINGTON Nylon Liquid Tight Connectors**

- For 1 cord
- Gray
- 1/2" conduit size
- ■ UL/CSA STANDARDS



Q #	cord dia	price
G1205696	1 3/16" to 1 1/2"	<b>\$1.20</b>
G1800802	3/4" to 5/8"	<b>\$1.86</b>

**TYRAP Steel Liquid Tight Connectors**

- For 1 cord
- Straight
- 1/2" conduit size
- ■ UL, CSA



Q #	cord dia
G2188374	3/8" to 3/4"
G1997825	5/16" to 5/8"

each **\$6.42**

**Aluminum**

Q #	cord dia
G3144924	3/8" to 3/4"
G1238824	5/16" to 5/8"

each **\$6.67**

**RACO Conduit Connectors**

- 1/2" flexible conduit size
- Malleable iron/steel



Q #	type	connection type	price
G0698327	noninsulated	straight	<b>\$3.06</b>
G3228233	insulated	straight	<b>\$3.20</b>
G0743364	noninsulated	90 degree	<b>\$4.95</b>
G1803566	insulated	90 degree	<b>\$6.73</b>

**HUBBELL WIRING DEVICE-KELLEMS Cable Connector**

- 1/2" conduit size
- NPT
- Black nylon
- .17" to .45" cord dia
- ■ UL, CSA, VDE



Q #	price
G1693921	<b>\$2.20</b>

**Locknut**

Q #	price
G0746347	<b>\$0.54</b>





# ELECTRICAL

MORE THAN 800,000 ITEMS ONLINE

## LEVITON Industrial Grade Straight Blade Plugs

- 2 pole
- 3 wire
- .245" to .7" cord size
- Nylon
- Black/white
- ■ UL/CSA

Z#	VAC	amperage	NEMA	price
G3124466	125	15A	5-15 P	<b>\$4.73</b>
G2669773	125	20A	5-20 P	<b>\$6.50</b>
G0290814	250	20A	6-20 P	<b>\$7.11</b>
G2435632	250	15A	6-15 P	<b>\$7.02</b>



## LEVITON Straight Blade Plug

- 125VAC
- 15 A
- NEMA 5-15 P
- Yellow PVC/steel
- .245" to .655" cord size
- ■ UL/CSA

Z#	price
G2213915	<b>\$2.22</b>



## LEVITON Straight Blade Plugs

- 125VAC
- 15 A
- 2 pole
- Thermoplastic rubber
- Black

Z#	grade	NEMA	wire	cord size	price
G1509462	general	1-15 p	2	.245" to .655"	<b>\$1.84</b>
G2308713	commercial	5-15 p	3	.245" to .7"	<b>\$1.97</b>



## LEVITON Dust Tight Plug

- 125VAC
- 15A
- NEMA 5-15 P
- Yellow santoprene TPV
- .375" to .655" cord size
- ■ UL/CSA/NOM

Z#	price
G3156325	<b>\$8.64</b>



## LEVITON Straight Blade Connectors

- 125VAC
- 15 A
- NEMA 5-15R
- 2 pole
- 3 wire
- .245" to .7" cord size

Z#	material	color	price
G1704017	nylon	black/white	<b>\$7.45</b>
G2579446	thermoplastic rubber	black	<b>\$3.63</b>



## LEVITON Slim GFCI Receptacle

- Commercial grade
- 125V
- 15A
- NEMA 5-15 R
- Duplex
- White
- ■ UL/CSA/NOM

Z#	price
G4626151	<b>\$7.94</b>



## HUBBELL WIRING DEVICE-KELLEMS Ribbed Straight Blade Plug

- 125VAC
- 15A
- NEMA 5-15 P
- Black/white nylon
- .230" to .720" cord size
- ■ UL/CSA

Z#	price
G2165773	<b>\$14.29</b>



## HUBBELL WIRING DEVICE-KELLEMS Commercial Grade GFCI Receptacles

- 125V
- 20A
- NEMA 5-20 R
- Duplex
- ■ UL/CSA

Z#	color
G2445003	ivory
G0321946	gray

each **\$12.31**

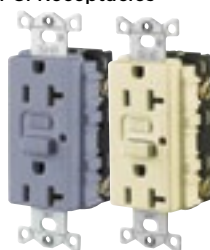

## BELL Weatherproof Outlet Boxes

- 1 gang
- Die cast aluminum
- 1/2" hub
- 2.75" w x 2" d x 4.5" h

Z#	inlets	price
G1091964	3	<b>\$1.94</b>
G0735874	4	<b>\$3.64</b>



## LEVITON Commercial Grade Receptacles

- 125V
- 20 A
- NEMA 5-20 R
- Duplex
- Thermoplastic
- ■ UL/CAS/NOM

Z#	color
G3080752	gray
G0931874	white
G1459473	ivory
G1645052	brown

each **\$1.40**



## RACO Electrical Box

- Welded
- 30.3 cu-in capacity
- Galvanized zinc
- 4" w x 2 1/2" d x 4" h

Z#	price
G2248626	<b>\$1.55</b>



## RACO Receptacle Cover

- For 2 duplex receptacles
- 6.5 cu-in capacity
- 4" x 4"
- Galvanized zinc
- includes screws

Z#	price
G3339734	<b>\$1.19</b>



**STEEL CITY  
Concealed Service  
Floor Box**

- Duplex
- Stamped steel
- 10 $\frac{1}{4}$ " w x 4 $\frac{1}{16}$ " d x 3 $\frac{3}{4}$ " h

Q #	price
G1435156	<b>\$85.52</b>

**Cover**

Q #	price
G3312093	<b>\$94.80</b>

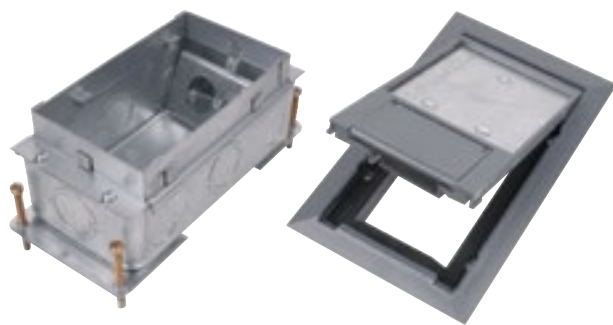

**STEEL CITY  
Round Floor Box**

- PVC
- 6" dia
- 6 $\frac{3}{8}$ " height

Q #	price
G1100547	<b>\$17.71</b>

**Cover**

Q #	price
G0744721	<b>\$25.35</b>



**POWER FIRST  
General Purpose Extension Cords**

- 125 V
- 15 max A
- NEMA 5-15 P, NEMA 5-15 R
- 1 outlet
- SJTW
- ■ UL, CUL

Q #	length	gauge	PVC jacket color	price
G3411204	10'	12/3	yellow with black stripe	<b>\$18.90</b>
G1123945	25'	12/3	orange with black stripe	<b>\$25.76</b>
G2647032	25'	12/3	yellow with black stripe	<b>\$41.15</b>
G0935663	50'	14/3	orange with black stripe	<b>\$39.47</b>
G1878624	50'	12/3	yellow with black stripe	<b>\$70.00</b>
G2029237	100'	12/3	yellow with black stripe	<b>\$109.65</b>



**HUBBELL WIRING DEVICE-KELLEMS  
Floor Box Cover Plug**

- For 2 $\frac{1}{2}$ " dia opening
- Brass

Q #	price
G1316436	<b>\$19.83</b>



**POWER FIRST  
Extreme Temperature Extension Cords**

- Stays flexible to -58° F
- 125 V
- Yellow PVC jacket
- SJTOW
- ■ UL, CUL

Q #	length	gauge	max amperage	NEMA	outlets	price
G0958465	50'	10/3	20 A	5-20 P, 5-20 R	1	<b>\$70.38</b>
G0646265	100'	10/3	20 A	5-20 P, 5-20 R	1	<b>\$127.49</b>
G2281675	6'	12/3	15 A	5-15 P, 5-15 R	6	<b>\$7.69</b>
G0762377	25'	12/3	15 A	5-15 P, 5-15 R	6	<b>\$23.83</b>



**3M  
Electrical Tape**

- Polyester
- 3/4" width
- 72 yd
- 1 mil

Q #	color
G4239864	white
G4290002	black

each **\$14.10**



**POWER FIRST  
Electrical Tape**

- Vinyl
- 3/4" width
- 66'
- 7 mil

Q #	color
G4538633	green
G4587073	white
G4593005	blue
G4582304	black

each **\$5.06**



**BAYCO  
Retractable Extension Cords**

- SJTW
- ■ UL, CSA

Q #	length	gauge	color	voltage	max amperage	price
G4140613	30'	14/3	black cord, black reel	600	13A	<b>\$45.77</b>
G4223554	50'	14/3	black cord, yellow reel	125	13A	<b>\$79.89</b>
G4191747	50'	12/3	black cord, yellow reel	600	15A	<b>\$84.40</b>



**ERITECH  
Ground Rods**

- 5/8" diameter
- Copper bonded steel
- 10 mil copper coating

**Rods**

Q #	length	price
G1320401	4'	<b>\$11.80</b>
G0255595	8'	<b>\$16.78</b>
G0815972	10'	<b>\$17.99</b>

**Clamp**

Q #	price
G1239743	<b>\$1.49</b>



**GREENLEE  
Electrician's  
Tool Bag**

- Black canvas
- 31 pockets
- 11" w x 18" d x 10" h

Q #	price
G2804496	<b>\$38.64</b>



**3M Utility Tape**

- Vinyl
- 2" width
- 150' length
- 6 mil
- Rubber adhesive

Q #	price
G4171081	<b>\$4.47</b>





# ELECTRICAL

MORE THAN 800,000 ITEMS ONLINE

## GENERAC Portable Generators

- Gasoline fueled
- 120/240 V

### Recoil Starter

Z#	rated watts	amperage	engine	tank	dimensions	price
G0611502	3250	27/13.5A	208 cc	6 hr	22" w x 22 3/4" l x 21" h	<b>\$479.39</b>
G3696856	5500	45.8/22.9A	389 cc	5 hr	27" w x 27" l x 25" h	<b>\$713.96</b>
G1509961	7500	62.5/31.3A	420 cc	6 hr	27" w x 27" l x 25" h	<b>\$1,031.58</b>

### Electric/Recoil Starter

Z#	rated watts	amperage	engine	tank	dimensions	price
G1256211	8000	66.7/33.3A	407 cc	5 hr	25" w x 31" l x 28" h	<b>\$1,492.58</b>

### Electric Starter

Z#	rated watts	amperage	engine	tank	dimensions	price
G0551065	10000	83.3/41.7A	530 cc	5 hr	29" w x 30" l x 31" h	<b>\$2,312.72</b>



## GENERAC Portable Inverter Generators

- Gasoline fueled
- 120 V
- Recoil starter

Z#	rated watts	amperage	engine	tank	dimensions	price
G1497352	800	6.6A	38 cc	1.8 hr	10" w x 18" l x 15" h	<b>\$347.33</b>
G0311674	2000	16.7A	126 cc	2.3 hr	12" w x 22" l x 18" h	<b>\$631.22</b>



## RELIANCE Manual Transfer Switches

- 125/250 V
- 7500 max wattage
- 60 max A
- Steel enclosure

Z#	circuits	price
G1575594	6	<b>\$304.55</b>
G2573453	10	<b>\$331.15</b>

## BRIGGS & STRATTON Portable Generators

- Gasoline fueled
- 120/240 V
- Electric/recoil starter

Z#	rated watts	amperage	engine	tank	dimensions	price
G1744872	7000	58.3/29.1A	420 cc	7 hr	23" w x 35" l x 27" h	<b>\$1,088.72</b>
G1994447	8000	66.6/33.3A	420 cc	7 hr	23" w x 35" l x 27" h	<b>\$1,299.99</b>
G1903675	10000	83.3/41.6A	570 cc	5 hr	28" w x 31" l x 28" h	<b>\$2,298.54</b>



## CEP Power Distribution Box

- 125/250 V
- 30 A
- 3 pole
- 4 wire
- 6' cord
- (4) L5-20R GFCI



Z#	price
G3027464	<b>\$433.07</b>

## BRIGGS & STRATTON Gas Can

- 5 gal capacity
- Red
- Polyethylene
- Self venting
- CARB, ASTM



Z#	price
G3400555	<b>\$21.53</b>

## GENERAC Generator Maintenance Kit

- For portable generators  
(Go online to find the right kit for your generator)
- includes oil filter, spark plug, wrench, precleaner, air cleaner elements, and fuel stabilizer*

Z#	price
G1712785	<b>\$25.99</b>



## CEP Generator Cords

- 120/240 V
- 1 outlet
- SOW
- Black
- UL



### With Pendant Box

Z#	length	gauge	max amperage	price
G7801647*	50'	12/4	20 A	<b>\$225.22</b>

### Without Pendant Box

Z#	length	gauge	max amperage	price
G4406306	100'	10/4	30 A	<b>\$379.49</b>

## POWER FIRST Cord Adapters

- 3' length
- 20 max A

Z#	voltage	watts	NEMA	gauge	price
G0860334	125	3750	5-20R, L5-30P	10/3	<b>\$29.76</b>
G1580144	125	3750	L5-20R, L5-30P	10/3	<b>\$33.24</b>
G2942676	125/250	3750	5-20R, L14-30P	10/4 & 10/3	<b>\$33.88</b>
G0458026	125/250	3750	L5-20R, L14-30P	10/4 & 10/3	<b>\$37.15</b>
G1993555	125/250	2500	L5-20R, L14-20P	12/4 & 12/3	<b>\$38.53</b>
G2332635	125/250	2500	5-20R, L14-20P	12/4 & 12/3	<b>\$32.77</b>







**GENERAC Liquid-Cooled Automatic Standby Generators**

- 60 Hz
- 120/240 V
- ■ UL, cUL, CSA

Z #	kW	amperage	engine	dBa	size	price
G2901001	22 LP/22 NG	91.6 A	2.4 L	61	36" w x 77" l x 40" h	<b>\$8,731.00</b>
G2913267	25 LP/25 NG	104 A	1.5 L	59	36" w x 77" l x 40" h	<b>\$8,235.00</b>
G0917621	27 LP/25 NG	112.5 A	2.4 L	61	36" w x 77" l x 40" h	<b>\$10,279.00</b>
G1420772	30 LP/30 NG	125 A	1.5 L	59	36" w x 77" l x 40" h	<b>\$9,280.00</b>
G1206256	45 LP/45 NG	187.5 A	2.4 L	61	41" w x 96" l x 53" h	<b>\$12,131.00</b>
G1551505	48 LP/48 NG	200 A	5.4 L	63	41" w x 84" l x 53" h	<b>\$14,415.00</b>

**GENERAC Air-Cooled Automatic Standby Generators**

- 60 Hz
- 25" w x 48" l x 29" h
- ■ UL, CSA



Z #	kW	voltage	amperage	engine	dBa	price
G5173953	11 LP/10 NG	120/240	50	530 cc	63	<b>\$2,783.51</b>
G7453573	20 LP/18 NG	240	83.3/75	999 cc	66	<b>\$4,289.87</b>

**GENERAC Automatic Transfer Switches**

- 240 V
- 1 phase
- NEMA 3R aluminum enclosure
- ■ UL, cUL



Z #	max amperage	kW	price
G2225203	100 A	22	<b>\$376.57</b>
G2584547	200 A	48	<b>\$653.34</b>

**DEWALT Electrical Code Reference**

- Paperback
- 88 pages



Z #	price
G3992195	<b>\$12.97</b>

**GENERAC Wet Cell Battery**

- 12 V
- For use with air and liquid cooled generators up to 60kW, except for 48kW model



Z #	price
G3990813	<b>\$90.44</b>

**ITP Master Electrician's Review**

- Paperback
- 416 pages



Z #	price
G4011052	<b>\$61.82</b>

**GENERAC Generator Maintenance and Upkeep**

**Maintenance Kits**

includes air filter, oil filter, spark plug, oil funnel, chamois, and reminder sticker

- For air cooled generators

Z #	price
G3990122	<b>\$18.99</b>



- For liquid cooled generators

Z #	price
G4087404	<b>\$57.99</b>

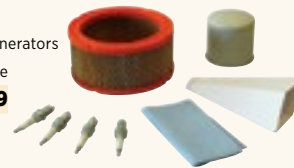

**Cold Weather Kits**

includes battery warmer and crankcase heater

- For air cooled generators

Z #	price
G4109944	<b>\$299.51</b>



- For liquid cooled generators

Z #	price
G4151515	<b>\$299.51</b>



**Battery Warmers**

- For air cooled generators
- 28" battery warmer with terminals and filter

Z #	price
G7249654	<b>\$300.21</b>

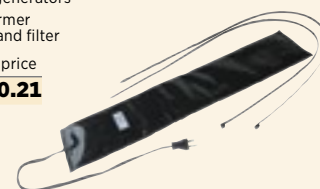

- For liquid cooled generators
- 44" battery warmer zip ties, thermostat

Z #	price
G7080211*	<b>\$330.71</b>

**WIHA Electrician's Tool Set**

- Insulated
- includes 8" long nose, 6<sup>3</sup>/<sub>16</sub>" stripping pliers, 9" combination pliers, inch/metric folding ruler, 8" high leverage cutters, 8<sup>3</sup>/<sub>16</sub>" knife, screwdrivers: slotted: 3, 4.5, 6 mm, phillips: 1, 2, square: 1, 2, terminal block driver: 1, 2, nut drivers: 3/4", 1/2", 13/32", 5/8", 3/16", 1/4", 7, 8, 10, 13 mm, molded tool box



Z #	price
G4570063	<b>\$372.26</b>

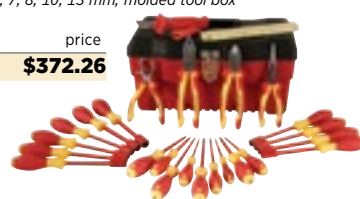



# ELECTRICAL

MORE THAN 800,000 ITEMS ONLINE



### LUMAPRO

#### Mini T3 LED Bulbs

- Non-dimmable
- Miniature bayonet base (BA9S)
- 20,000 hr life

Z#	initial lumens	watts	voltage	color
G5038713	10	0.3	6	500 nm warm white
G5038686	7	0.8	120	525 nm green

each **\$17.78**



### LUMAPRO Mini T6 LED Bulbs

- Non-dimmable
- Candelabra screw base (E12)
- 20,000 hr life
- 450 nm white

Z#	initial lumens	watts	voltage
G5038652	15	0.18	12
G5038677	7	0.36	24
G5038643	8	1.2	120

each **\$18.55**



### LUMAPRO

#### T2 Mini LED Bulbs

- Tel. slide No. 5 base
- 120 V, 1.2 W
- 50,000 hr life

Z#	color	price
G3164393	white	<b>\$3.19</b>
G1193631	red	<b>\$3.28</b>
G0717482	green	<b>\$3.28</b>



### LUMAPRO

#### Mini Bi-Polar LED Bulbs

- T3 ¼ shape
- Miniature bayonet base (BA9S)
- 100,000 hr life
- Warm white

Z#	voltage
G3119146	12
G0559483	120

each **\$23.45**

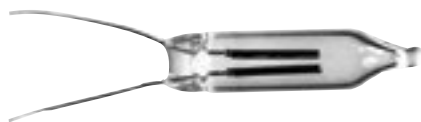

### LUMAPRO

#### Mini-T Neon Indicator Bulbs

- Wire terminal base
- 105-125 V
- 25,000 hr life
- 10 pack

Z#	lamp shape	price
G3390186	T2 (NE-2H)	<b>\$9.52</b>
G2969206	T3 (NE-2)	<b>\$12.35</b>



### PHILIPS

#### PAR20 Dimmable LED Bulbs

- Medium screw base (E26)
- 8 W, 120 V
- 25,000 hr life

Z#	initial lumens	beam angle	color	price
G4883706	450	25°	2700K soft white	<b>\$21.81</b>
G4883663	470	25°	3000K warm white	<b>\$20.52</b>
G4883697	450	36°	2700K soft white	<b>\$23.90</b>
G4883681	450	36°	3000K warm white	<b>\$23.88</b>



### PHILIPS

#### BR30 Dimmable LED Bulb

- Medium screw base (E26)
- 650 initial lumens
- 9.5 W, 120 V
- 2700K warm white

Z#	price
G7530485	<b>\$14.88</b>



### GE LIGHTING

#### A19 Dimmable LED Bulbs

- Medium screw base (E26)
- 120 V
- 2700K soft white
- Non-dimmable

Z#	initial lumens	watts	price
G5230881	450	7	<b>\$15.58</b>
G5212943	800	10.5	<b>\$12.99</b>



### GE LIGHTING

#### S14 Non-Dimmable LED Bulbs

- Medium screw base (E26)
- 100 initial lumens
- 2.4 W, 120 V
- 15,000 hr life

Z#	color	price
G4634454	3000K clear	
G4554654	3000K frosted white	

each **\$14.44**

**PHILIPS LED T8 Bulbs**

- Medium bi-pin base (G13)
- 50,000 hr life

Z#	initial lumens	color	voltage
G7523984	2000	3,500K bright white	200-420
G7476314	2100	4000K cool white	100-277

each **\$28.45****LUMAPRO PAR/BR LED Spotlights**

- Non-dimmable
- Medium Screw (E26)
- 4.5W, 100-240V
- 50,000 hr life



Z#	initial lumens	color
G3389811	150	3000K warm light
G2743544	195	3500K neutral light

each **\$29.16****LUMAPRO High Pressure Sodium HID Bulbs**

- ED17 shape
- Medium screw base (E26)
- 24,000 hr life
- 2000K clear



Z#	initial lumens	watts	price
G2413397	4000	50	<b>\$25.07</b>
G2512447	6300	70	<b>\$23.21</b>
G1802017	14,500	150	<b>\$25.96</b>

**GE LIGHTING Shatter Resistant Incandescent Bulbs**

- Medium screw base (E26)
- 130/120V
- 2800K inside frost



Z#	shape	initial lumens	watts	price
G0431207	A19	1070/813	100/89	<b>\$4.03</b>
G0605507	A21	2065/1580	150/133	<b>\$4.45</b>

**LEVITON Bulb Socket Adapters**

- Mogul to medium base
- 600 W, 250 V
- Screw in mounting
- Aluminum shell/porcelain finish



Z#	type	price
G3093413	standard	<b>\$2.35</b>
G2942475	4 KV	<b>\$5.94</b>

**GE LIGHTING Dimmable Plug-In CFL Bulb**

- Double D, T6 shape
- 4-pin base (GRY10Q-3)
- 4000 initial lumens, 55 W
- 10,000 hr life
- 3000K soft white



Z#	price
G0836491	<b>\$13.72</b>

**GE LIGHTING PAR30 Dimmable LED Reflector Bulbs**

- Medium screw base (E26)
- 820 initial lumens
- 12 W, 120 V
- 25,000 hr life
- 2700K silver light
- Beam angle 25°



Z#	price
G4573667	<b>\$50.59</b>

**WOBBLE LIGHT Spiral Screw-In CFL Bulb**

- Non-dimmable, mogul base
- 9000 initial lumens
- 85W, 120V
- 10,000 hr life
- 4100K cool light



Z#	price
G3456101	<b>\$24.10</b>

**LUMAPRO Dimmable LED Reflector Bulbs**

- Medium screw base (E26)
- 120V
- 50,000 hr life
- Indoor/outdoor



Z#	shape	initial lumens	watts	color	price
G4858472	R20	500	8	5700K daylight	<b>\$29.97</b>
G4858481	R30	575	11	2700K soft white	<b>\$41.31</b>

**LEVITON Bulb Socket Extensions**

- Screw in connection
- 660 W, 250 V
- Medium base
- Use with incandescent and halogen bulbs



Z#	material	color	price
G3110651	porcelain	white	<b>\$2.21</b>
G2533876	phenolic	black	<b>\$1.95</b>

**LEVITON Fluorescent Bulb Holders**

- Quickwire push-in connection
- 660 W, 600 V
- White



Z#	base	mounting	price
G1328966	plunger	low-profile slide-on	<b>\$1.84</b>
G2609065	fixed	low-profile slide-on	<b>\$2.02</b>
G0545036	medium	slide-on	<b>\$2.05</b>
G1028361	fixed	double pedestal	<b>\$2.30</b>
G2438834	plunger	snap-in	<b>\$2.52</b>
G0621433	plunger	double pedestal	<b>\$3.41</b>



# ELECTRICAL

## LEVITON Weatherproof Bulb Holder

- Medium base
- 6" pigtail
- 250 V
- 660 W
- Aluminum shell with black rubber finish



Z#	price
G3238024	<b>\$1.79</b>

## LEVITON Ceiling Mount Bulb Holder

- Medium base
- Screw terminal
- 250 V
- 660 W
- Porcelain



Z#	price
G2690651	<b>\$0.99</b>

## LEVITON Fluorescent Bulb Starters

- 2 pins
- Medium
- IEC 15S, UL
- features humidity resistant ceramic condenser



Z#	watts	price
G1128766	14, 15, 20	<b>\$0.87</b>
G1053044	22, 25	<b>\$1.42</b>

## UNGER Bulb Changers

- Attach to extension pole
- For 3.25" dia flood lights
- 300 W and larger



Z#	price
G2514775	<b>\$15.92</b>

## UNGER Bulb Changers

- Attach to extension pole

Z#	used for	price
G2015912	spotlights	<b>\$12.42</b>
G0937081	broken bulbs	<b>\$13.79</b>

Z#	price
G1264925	<b>\$46.09</b>



## GE LIGHTING ProLine Electronic Ballasts

- Instant start
- T12 bulbs

Z#	no. of bulb	voltage	amperage ac	price
G2446604	1-2	120/277	1.24 to .2	<b>\$27.88</b>
G0614774	2	120	.62	<b>\$12.55</b>

## PHILIPS ADVANCE Magnetic Ballasts

- 120 V
- Preheat start
- 11 W
- 1 bulb

Z#	price
G1442305	<b>\$7.45</b>



## PHILIPS ADVANCE Electronic Dimming Ballasts

- 2 bulb
- 120/277 V
- T5 bulb
- .57 to .24 A

Z#	price
G3124536	<b>\$49.30</b>



## PHILIPS ADVANCE Centium Electronic Ballasts

- Instant start
- T8 bulbs
- 120/277 V

Z#	no. of bulb	amperage ac	price
G2258243	4	.94 to .41	<b>\$17.03</b>
G2459737	2	.5 to .21	<b>\$19.85</b>
G1926005	1-2	.5 to .21	<b>\$14.93</b>
G1857222	1-2	.62 to .26	<b>\$12.92</b>



## PHILIPS ADVANCE HID Ballast Kits

- Metal halide bulbs
- 120/208/240/277 V
- 1 bulb

Z#	start	amperage ac	price
G0383625	probe	4/2.3/2/1.75	<b>\$67.90</b>
G1443452	pulse	1.2/.7/6/.5	<b>\$69.99</b>



## GE LIGHTING Electronic Dimming Ballasts

- 120/277 V

Z#	bulb	no. of bulb	amperage ac	price
G2990023	F32T8	4	.34	<b>\$27.57</b>
G3604937	T8	2	.5	<b>\$40.78</b>

## LITHONIA Linear Fluorescent Battery Packs

- Nickel cadmium batteries



Z#	bulbs	watts	initial lumens	housing material	price
G0625353	T8 and T12	40	500	steel	<b>\$49.90</b>
G2137913	T5, T8, T12, HO, Biax	75	600 to 700	thermoplastic	<b>\$132.29</b>
G1633432	T5, T8, T12, HO, Biax	80	1100 to 1400	thermoplastic	<b>\$150.74</b>

**HALO Recessed Lighting Trim**

- Baffle splay
- Fits 5" housings
- R20, PAR20, BR30, PAR30 bulbs (not included)
- White ring/white baffle
- Metal housing



#	price
G2016454	<b>\$19.41</b>

**HALO Recessed Lighting Trim**

- Coilex baffle
- Fits 6" housings
- PAR30, BR30, R30 bulbs (not included)
- White ring/black baffle
- Metal and plastic housing



#	price
G0681834	<b>\$19.66</b>

**LITHONIA High Abuse Incandescent Fixture**

- 120 V
- 100 bulb watts
- (1) bulb (not included)
- White steel housing
- 5 7/8" w x 8 1/2" l x 4 1/2" h



#	price
G3072352	<b>\$31.43</b>

**HALO Recessed Lighting Trim**

- Albalite lens
- Bulbs not included



#	fits housing	bulb	housing	price
G2392232	6"	A19, 40W max	white polymer	<b>\$25.43</b>
G1467426	6"	A19, 60W max	white polymer	<b>\$25.56</b>
G0691433	8" square	A19	white metal	<b>\$23.09</b>

**LITHONIA Industrial Fluorescent Fixture**

- 120-277 VAC
- 28 bulb watts
- (4) F32T8 bulbs (not included)
- High gloss baked white enamel housing
- 16" w x 48" l x 5 1/2" h

#	price
G2712963	<b>\$104.70</b>



**LUMAPRO Shop Fluorescent Light Fixture**

- Cord and chain
- 120 VAC
- 34 bulb watts
- (2) F34T12 bulbs (not included)
- 5 1/2" w x 48" l x 3 1/2" h



#	price
G1086951	<b>\$30.33</b>

**LITHONIA Enclosed and Gasketed Dust Resistant Fixtures**

- 32 bulb watts
- 120 to 277 V
- (2) T8 bulbs (not included)
- White polyester housing
- 8 3/8" w x 50" l x 4 3/4" h

#	price
G2786734	<b>\$111.56</b>

**Replacement Lens**

#	price
G0498644	<b>\$41.25</b>



**LITHONIA Wall Mount Fluorescent Fixture**

- 32 bulb watts
- 120 to 277 V
- (2) F32T8 bulbs (not included)
- 7 1/4" w x 49 7/16" l x 3 3/4" h

#	price
G3194414	<b>\$139.17</b>

**Replacement Diffuser**

#	price
G3487854	<b>\$42.20</b>



**LITHONIA Vapor Tight Incandescent Fixture**

- 120 V
- 150 bulb watts
- (1) bulb (not included)
- Cast aluminum housing
- Clear glass globe
- 4 1/2" x 9"

#	price
G2621595	<b>\$29.92</b>



**LITHONIA Recessed Fluorescent Lens Troffers**

- 32 bulb watts
- 120 to 277 V
- F32T8 bulbs (not included)
- 24" w x 48" l x 3 3/16" h
- Steel housing

#	bulbs
G1902537	3
G2886405	4

each **\$59.42**

**Replacement Lens**

#	item	price
G1380443	replacement lens	<b>\$17.99</b>



**KILLARK Hazardous Location Incandescent Fixture**

- 120-277 V
- 150 bulb watts
- (1) A19/A21 bulb (not included)
- Gray polyester housing
- 4 5/16" x 12 1/4"

#	price
G3071092	<b>\$87.38</b>





# ELECTRICAL

## VALUE BRAND Prismatic Light Panels

- Clear styrene
- For use with 4' x 2' fluorescent fixtures
- 23 $\frac{3}{4}$ " x 47 $\frac{3}{4}$ "
- .085" thickness
- 5 pack

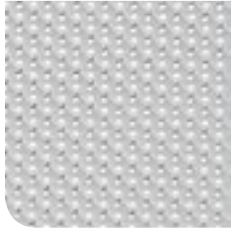

#	price
G0374141	<b>\$62.55</b>

## LUMAPRO Wet Location Fluorescent Fixture

- 120-277 V
- 32 bulb watts
- (2) T8, 4FT bulbs (not included)
- 6" w x 50" l x 4 $\frac{13}{64}$ " h
- Gray polycarbonate housing



#	price
G4988724	<b>\$98.62</b>

## APPLETON ELECTRIC Hazardous Location Incandescent Fixture

- 120 V
- 200 bulb watts
- (1) 200A21/IF bulb (not included)
- 5 $\frac{1}{4}$ " x 9"
- Gray epoxy powder coated housing



#	price
G0868201	<b>\$96.76</b>

## CREE LED Linear Luminaires

- 120-277 V
- 10" w x 96" l x 5 $\frac{1}{8}$ " h

#	bulb watts	color temp	price
G5980615*	73	3500K	<b>\$505.01</b>
G5035581	75	4000K	<b>\$599.25</b>



## LITHONIA Fluorescent High Bay Fixtures

- 120-277 V
- High gloss baked white enamel housing
- Bulbs not included

#	bulb watts	no. of bulbs	dimensions	price
G1020074	28	6 T8	18 $\frac{3}{8}$ " w x 48 $\frac{3}{8}$ " l x 4 $\frac{3}{8}$ " h	<b>\$145.32</b>
G2611637	32	4 T8	13 $\frac{3}{4}$ " w x 48 $\frac{1}{2}$ " l x 2 $\frac{3}{8}$ " h	<b>\$132.10</b>
G2072436	32	6 T8	18 $\frac{1}{2}$ " w x 48 $\frac{1}{2}$ " l x 2 $\frac{3}{8}$ " h	<b>\$146.93</b>
G2935213	51	4 T5HO	13 $\frac{3}{4}$ " w x 48 $\frac{1}{2}$ " l x 2 $\frac{3}{8}$ " h	<b>\$128.49</b>
G0762002	51	4 T5HO	18 $\frac{1}{2}$ " w x 48 $\frac{3}{8}$ " l x 4 $\frac{3}{8}$ " h	<b>\$284.17</b>

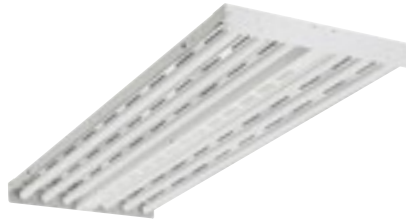

## LUMAPRO Ceiling Mount Fixtures

- 120 V
- Bulbs not included

#	bulb watts	no. of bulbs	dia	housing finish	price
G2700975	13	2 F13DBX (4 Pin)	11"	white metal	<b>\$51.76</b>
G3299256	22	1 FC8T9	11"	white metal	<b>\$51.44</b>
G2647601	22/32	2 FC8T9/FC12T9	12"	chrome metal	<b>\$60.59</b>
G2363322	32	1 FC12T9	12"	chrome metal	<b>\$54.03</b>



## LITHONIA Flush Ceiling Mount Fixture

- 120 VAC
- 22/32 bulb watts
- (2) FC8T9/FC12T9 bulbs
- 14 $\frac{1}{4}$ " w x 14 $\frac{3}{4}$ " l x 3 $\frac{3}{8}$ " h
- White acrylic housing

#	price
G0571794	<b>\$61.01</b>



## LUMAPRO Decorative Ceiling Mount Fixtures

- 120 V
- 60 bulb watts

#	no. of bulbs	dia	housing	glass lens	price
G2188146	1 A19	8 $\frac{1}{2}$ "	white steel	white	<b>\$20.86</b>
G1019313	2 A19	13 $\frac{1}{2}$ "	white steel	frosted swirl	<b>\$27.50</b>



## LUMAPRO Decorative Wall Mount Fixtures

- 120 V
- Bulbs not included

#	bulb watts	no. of bulbs	size	housing	lens	price
G2703906	75	(1) A19	4 $\frac{1}{4}$ " x 8"	white steel	ceramic glass	<b>\$20.90</b>
G2160645	100	(1) A19 or B11	5" x 5 $\frac{1}{2}$ "	polished brass	frosted glass	<b>\$20.49</b>
G2841684	100	(1) A19 or B11	6" x 10 $\frac{1}{2}$ "	chrome steel	frosted glass	<b>\$38.15</b>



## HUBBELL KILLARK LED Fixtures

- 120-277 V
- 4" x 3 $\frac{3}{4}$ "
- Gray copper-free aluminum housing

### Fixtures

#	bulb watts	price
G4545721	13	<b>\$343.23</b>
G4630604	16	<b>\$348.15</b>



### Glass Bulbs

#	color	price
G4611406	blue	<b>\$72.66</b>
G4636107	red	<b>\$72.66</b>
G4577431	amber	<b>\$72.66</b>



### Mounting Bracket

#	price
G4544382	<b>\$22.29</b>



## LUMAPRO Undercabinet LED Fixtures

- 120 V
- Brushed aluminum housing

#	bulb watts	dimensions	price
G4875857	6	3 $\frac{3}{8}$ " w x 14" l x 1" h	<b>\$62.57</b>
G4886357	12	3 $\frac{3}{8}$ " w x 30" l x 1" h	<b>\$109.97</b>



**LUMAPRO**  
**Gooseneck Task Lights**  
 • Incandescent bulb (not included)  
 • 120V  
 • Chrome/black

#	watts	arm	cord	description	price
G2851484	25	18"	8'	domed L-bracket	<b>\$47.95</b>
G3163081	60	18"	8'	domed magnetic	<b>\$61.64</b>
G1862357	60	24"	8'	machine tool	<b>\$63.39</b>

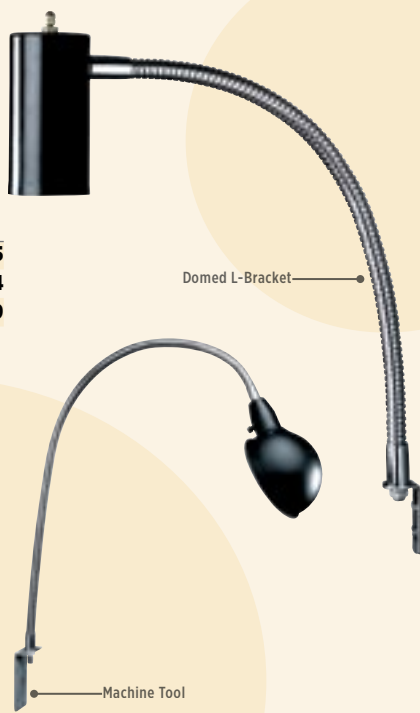

**DAYTON**  
**Bench Grinder Work Light**  
 • LED  
 • 6' cord  
 includes mounting hardware and LED bulb

#	price
G4860116	<b>\$54.86</b>



**AVEN**  
**Magnifying Work Light**  
 • Fluorescent  
 • 22W  
 • 45" arm  
 • 5' cord  
 • Ivory

#	price
G4035561	<b>\$78.85</b>



**ELECTRIX**  
**Gooseneck Task Lights**  
 • 120V  
 • 22" arm  
 • 8' cord  
 • Black steel

#	bulb	watts	mount	price
G3482017	incandescent	100	L-bracket	<b>\$51.66</b>
G1225061	LED	5	clamp	<b>\$203.12</b>

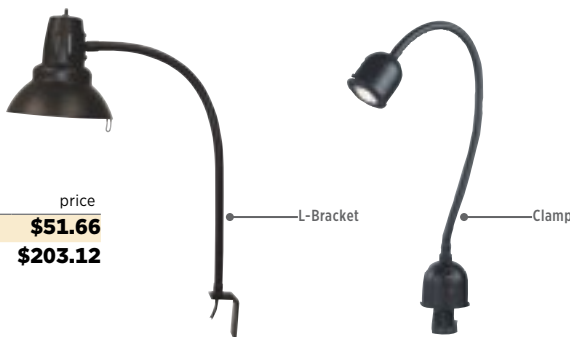

**LUXO**  
**Architect Task Light**  
 • Fluorescent  
 • 120V, 23W  
 • 45" arm  
 • 6' cord  
 • Aluminum

#	price
G3719326	<b>\$165.24</b>



**WALDMANN**  
**Articulating Arm Task Light**  
 • 120V  
 • 20W  
 • 27" arm  
 • 10' cord  
 • Black powder coated metal

#	price
G3235994	<b>\$427.64</b>



**WALDMANN**  
**Machine Tool Task Lights**  
 • LED  
 • 24VDC  
 • Oleflex oil resistant cord

#	watts	length	price
G3627407	2 x 6	14.1"	<b>\$435.47</b>
G3727281	14.4	24.3"	<b>\$402.96</b>



**ELECTRIX**  
**Pivoting Head Task Light**  
 • Halogen  
 • 120V  
 • 55W  
 • Waterproof

#	price
G1963473	<b>\$189.69</b>



**WALDMANN**  
**Pivoting Head Task Light**  
 • 12V  
 • 20W  
 • 6' cord  
 • Black powder coated metal

#	price
G3153376	<b>\$165.59</b>



**ELECTRIX**  
**Gooseneck Task Lights**  
 • Halogen  
 • 120V  
 • 20W  
 • 25" arm  
 • 9' cord

#	mount	price
G0910892	magnetic	<b>\$103.05</b>
G1045231	clamp-on	<b>\$111.53</b>





# ELECTRICAL

## ECLIPSE Magnifying Desk Light

- Fluorescent
- 12W
- 11" arm
- 5' cord



Z#	price
G4477566	<b>\$37.32</b>

## CEP Light String

- LED
- 120V
- 33W
- 50'
- 5 sockets

Z#	price
G4309654	<b>\$242.99</b>



## LUMAPRO Portable Work Light with Handle

- Quartz halogen
- 120 VAC
- 500 W
- 12' cord



Z#	price
G2561404	<b>\$29.48</b>

## Replacement Bulbs

- 4 pack

Z#	price
G2264726	<b>\$27.66</b>



## PELICAN Portable Remote Area Lighting System

- LED
- 12V
- 1,000 low/2,000 high lumens
- 66" cord length
- 32 1/4" max height



Z#	price
G4474181	<b>\$644.99</b>



## LUMAPRO Clamp Lights

- Incandescent
- 120V

Z#	watts	cord	material	price
G3044903	150	12'	aluminum	<b>\$18.82</b>
G3391595	300	8'	aluminum	<b>\$36.09</b>

## NATIONAL ELECTRIC MFG Rechargeable Telescoping Work Light

- LED
- 9.6V
- Cordless
- Cushion grip handle

Z#	price
G4237886	<b>\$67.99</b>



## LUMAPRO Light Strings

- Incandescent
- 120V
- 150W

includes plastic cage guards



Z#	length	sockets	price
G3025303	50'	5	<b>\$190.26</b>
G1052213	100'	10	<b>\$293.83</b>

## Metal Cage Guards

Z#	price
G2788502	<b>\$7.93</b>



## FOSTORIA Portable Floodlight

- Quartz halogen
- 120V
- 500W
- 15' cord
- Black powder coated
- Aluminum



Z#	price
G1972467	<b>\$50.06</b>

## W F HARRIS LIGHTING Portable Floodlight

- Incandescent
- 120V
- 75W
- 6' cord
- Yellow polycarbonate



Z#	price
G0961852	<b>\$107.25</b>

## FOSTORIA Twin Head Mobile Work Light

- Quartz halogen
- 120V, 500 x 2W
- 98" max height
- Cart and tray base
- 15' cord

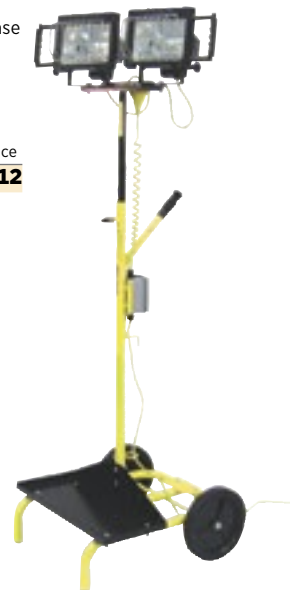

Z#	price
G2525311	<b>\$357.12</b>

## WOBBLE LIGHT Portable Work Lights

- 120VAC
- Self-righting
- Yellow



Z#	bulb type	watts	lumens	max height	price
G2977825	compact fluorescent	85	5,000	27"	<b>\$129.99</b>
G4105123	halogen	500	8,000	36"	<b>\$204.99</b>
G2063844	metal halide	175	15,000	36"	<b>\$264.99</b>
G1673314	metal halide	400	40,000	36"	<b>\$324.99</b>





**LITHONIA**  
**Emergency Light Fixtures**

- 120/277 input V



**3 Watt**

- (24) LED bulbs
- White thermoplastic housing
- 2 3/4" w x 10 1/4" l x 4 1/4" h

#	price
G0688046	<b>\$72.95</b>



**3.6 Watt**

- (2) LED bulbs
- White thermoplastic housing
- 2 3/4" w x 10" l x 4 1/4" h

#	price
G4312926	<b>\$25.23</b>



**5.4 Watt**

- (2) krypton bulbs
- White thermoplastic housing
- 3 3/4" w x 11 1/2" l x 5" h

#	price
G1040216	<b>\$46.65</b>



**8 Watt**

- (2) halogen bulbs
- White metal housing
- 3 3/4" w x 12" l x 12" h

#	price
G2124823	<b>\$74.65</b>



**9 Watt**

- (2) krypton bulbs
- White thermoplastic housing
- 4 3/4" w x 12 3/4" l x 7" h

#	price
G1570247	<b>\$82.60</b>



**10.8 Watt**

- (2) krypton bulbs
- White thermoplastic housing
- 3 3/4" w x 12 1/2" l x 5" h

#	price
G0950573	<b>\$73.98</b>



**LITHONIA**  
**Security Lights**

- 120 V
- Bronze aluminum housing
- 12" width

#	type	price
G2405952	dusk to dawn	<b>\$109.35</b>
G1381021	motion sensing	<b>\$144.99</b>

**COOPER LIGHTING**  
**Emergency Light Fixture**

- 120/277 or 120/230 input V
- (2) incandescent bulbs
- White ABS housing
- 16 1/2" x 5 3/8"

#	price
G4001121	<b>\$93.65</b>



**STONCO**  
**Adjustable Head Motion Sensor**

- Quartz halogen
- 120 V
- 300 W max load
- 3,200 sq-ft coverage
- 270° viewing

#	price
G2149043	<b>\$81.37</b>



**LITHONIA**  
**Security Light Fixtures**

- High pressure sodium
- 120 V
- Aluminum housing
- Acrylic lens

#	watts	dimensions	price
G1763404	100	12" w x 15 1/2" l x 12" h	<b>\$72.99</b>
G3003831	100	12" w x 15 1/2" l x 12" h	<b>\$86.93</b>
G2706103	150	13" w x 15 1/2" l x 17" h	<b>\$88.08</b>



**LITHONIA**  
**Miniature Wall Mount Fixtures**

- Polycarbonate
- Includes photocell
- 120 V

#	watts	dimensions	price
G3741114	42	5 3/4" w x 4 3/8" l x 11" h	<b>\$54.98</b>

#	watts	dimensions	price
G0668385	70	6 1/2" w x 5 3/4" l x 11" h	<b>\$75.01</b>



**LUMAPRO**  
**Infrared Motion Sensors**

- 120 V
- 500 W max load
- 21,000 sq-ft coverage
- 240° viewing
- Incandescent

#	color	price
G2892312	bronze	<b>\$32.85</b>
G1814303	white	<b>\$32.85</b>



**LUMAPRO**  
**Infrared Motion Sensor with Light Kit**

- Incandescent
- 120 V
- 300 W max load
- 21,000 sq-ft coverage
- 240° viewing

#	price
G2507486	<b>\$45.52</b>



**LUMAPRO**  
**Wall Mount Fluorescent Fixture**

- 120 V
- 126 W
- Aluminum housing
- 12" w x 14 1/2" l x 7 1/4" h

#	price
G2071587	<b>\$207.77</b>





# ELECTRICAL

## ACUITY AMERICAN ELECTRIC LED Security Light Fixture

- 120 V
- 60 W
- 5,200 lumens
- 12" w x 12" l x 17½" h
- Aluminum housing

**Z#** price  
**G4973351 \$363.86**



## ACUITY LITHONIA Parking Area Lights

- 120-277 V
- 91 W
- 13" w x 26" l x 7" h
- Aluminum housing

**Z#** lumens mount  
**G5878686\* 9,776 square pole**  
**G5909285\* 10,060 round pole**  
 each **\$1,188.82**



## LUMARK LED Wall Mount Fixtures

- Aluminum housing
- 120 VAC**
- 10 W
- 720 lumens
- 5¼" w x 3¾" l x 6¾" h

**Z#** price  
**G4483683 \$192.60**



- 120-277 VAC**
- 30 W
- 2,240 lumens
- 6¾" w x 4" l x 8" h

**Z#** price  
**G4483595 \$326.48**



## LUMAPRO Quartz Halogen Floodlight

- 120 V
- 500 W
- 9" w x 4" d x 6½" h
- Aluminum housing

**Z#** price  
**G1340692 \$31.67**



## ACUITY LITHONIA Quartz Halogen Floodlights

- Aluminum housing

**500 W**  
**Z#** voltage dimensions price  
**G1529306 120 8¾" w x 3½" d x 6½" h \$18.13**  
**1500 W**  
**Z#** voltage dimensions price  
**G1907683 120 to 277 13" w x 6" d x 8¾" h \$44.25**



## LITHONIA Compact Fluorescent Floodlight

- 120 V
- 26 W
- 8¾" w x 3½" d x 6½" h
- Aluminum housing

**Z#** price  
**G0437507 \$42.90**

## LUMAPRO Mini Bullet Landscape Lights

- 120 VAC
- Aluminum housing

<b>Z#</b>	bulb	watts	size	price
G4855952	halogen	35 max	2¾" h x 2" dia	<b>\$19.18</b>
G4855977	halogen	50 max	3¾" h x 2½" dia	<b>\$20.74</b>
G4856013	incandescent	150 max	7½" h x 5½" dia	<b>\$37.26</b>



## HUBBELL LED Floodlight

- 120-277 VAC
- 10.7 W
- 489 lumens
- 1½" w x 12" d x 7" h
- Aluminum housing

**Z#** price  
**G3910112 \$229.74**



## TAYMAC Bulbholder Kits

- 120 max V
- Aluminum housing

### Wall/Ceiling Mount Incandescent

- 150 W
- White powder coat

**Z#** price  
**G5201621 \$8.94**



### Swivel Halogen

- 75 W
- Bronze powder coat

**Z#** price  
**G4524886 \$13.57**



## GOLIGHT Remote-Controlled Spotlights

- Halogen
- Weatherproof
- 12 VDC
- 5.5 A DC
- 400,000 candle power

**Z#** dimensions color price  
**G3916044 6½" w x 7" d x 7" h white \$215.09**  
**G3913594 8" w x 7" d x 7" h charcoal \$162.78**



**WALDMANN Medical Lights**

- 120 V
- 8' cord
- Aluminum/plastic
- Clear lens

**Halogen**

Ⓜ #	watts	arm	price
G5952511*	35	37"	<b>\$371.89</b>
G1592893	50	32"	<b>\$418.38</b>
G2227416	50	36"	<b>\$374.96</b>

**LED**

Ⓜ #	watts	arm	price
G2643365*	25	37"	<b>\$1,162.06</b>

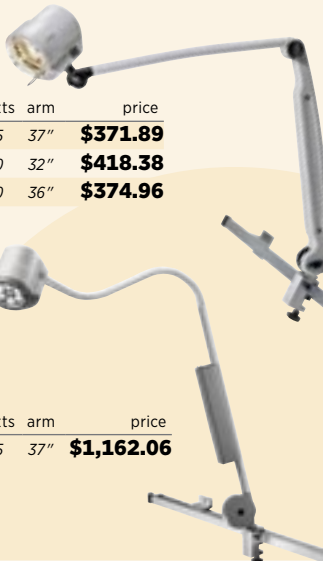

**SUNNEX Surgical Exam Lights**

- Halogen
- 120 V
- 10' cord

**Ceiling Mount**

- 105 W
- 28" arm

Ⓜ #	price
G2755812	<b>\$1,911.65</b>



**Wall Mount**

- 60 W
- 30" arm

Ⓜ #	price
G2372781	<b>\$1,206.19</b>



**WALDMANN Floor Stand Medical Light**

- Halogen
- 120 V
- 50 W
- 26" arm
- 8' cord
- Steel/plastic
- Clear lens

Ⓜ #	price
G5941713*	<b>\$1,898.87</b>

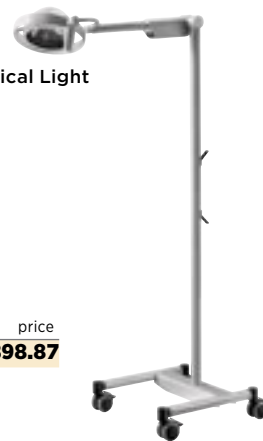

**DANIEL WOODHEAD Fluorescent Handheld Work Light**

- 120 V
- 13 W
- Rubber handle
- 13½" length
- includes mounting hook*

Ⓜ #	price
G2403852	<b>\$132.09</b>



**LUMAPRO LED Cord Reel Lights**

- 120 VAC
- 5 W
- Plastic housing
- SJT
- includes mounting hook*

Ⓜ #	cord	gauge	handle	price
G1883944	25'	16/3	14" oval	<b>\$218.90</b>
G2562567	25'	18/2	14" straight	<b>\$156.94</b>
G0608492	25'	18/2	19" straight	<b>\$178.20</b>
G1563353	40'	18/2	19" straight	<b>\$191.97</b>



**BAYCO PRODUCTS INC Rechargeable LED Work Light**

- 10½" length
- Plastic
- includes AC and DC chargers, clip-on magnet and metal hook*

Ⓜ #	price
G4147875	<b>\$36.11</b>



**BAYCO Fluorescent Cord Reel Light**

- 40' cord
- SJT
- 16/3 gauge

Ⓜ #	price
G4169042	<b>\$47.89</b>



**NATIONAL ELECTRIC MFG Fluorescent Cord Reel Light**

- 50' cord
- SJTOW
- 18/2 gauge

Ⓜ #	price
G4167606	<b>\$183.08</b>



**LUMAPRO LED Work Light**

- 120 V, 2.5 Watts
- 25' cord
- SJT, 18/2 cord
- Plastic housing
- 14" length

Ⓜ #	price
G2708377	<b>\$88.82</b>



**DANIEL WOODHEAD Incandescent Handheld Work Light**

- 120 VAC
- Aluminum with tempered glass lens
- includes mounting hook*

Ⓜ #	price
G2956633	<b>\$315.69</b>



**LUMAPRO Handheld Incandescent Work Light**

- 125 VAC
- 100 W
- 25' cord
- SJTW, 14/3 cord
- Metal housing

Ⓜ #	price
G0429563	<b>\$46.49</b>



**STANDARD PORTABLE LED Work Light**

- 120 VAC
- 5 W
- 15' cord
- SJT, 18/2 cord
- Plastic housing
- 17½" Length

Ⓜ #	price
G3664857	<b>\$160.87</b>





# ELECTRICAL

## CYALUME TECHNOLOGIES Lightsticks

- 12 hr duration
- 6" length
- includes hook*

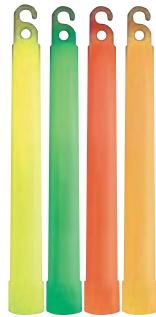

Z#	color
G0983394	yellow
G2948644	green
G2138814	red
G3004601	orange

each **\$10.40**

## ENERGIZER High Intensity LED Flashlight

- Aluminum body
- 185 lm output, 90m beam distance
- Water & impact resistant
- 5 3/4" length
- includes (2) AA batteries*



Z#	price
G4308744	<b>\$20.55</b>

## WESTWARD Incandescent Industrial Flashlight

- ABS body
- 4 lm output
- 328' beam distance
- 50,000 hr life
- D batteries required (2), NOT included



Z#	price
G3047213	<b>\$6.05</b>

## BAYCO Nightstick Safety Approved Flashlights

- Polymer body
- LED beam
- Waterproof, impact & chemical resistant
- 50,000 hr life
- AA batteries required (3), NOT included



Z#	lm output	focus	price
G1684094	120/120/240	adjustable	<b>\$31.39</b>
G1913974	140	fixed	<b>\$24.86</b>

## PELICAN Safety Approved Submersible Flashlight

- ABS body
- 53 lm output, 158m beam distance
- Waterproof
- C batteries required (3), NOT included



Z#	price
G0172706	<b>\$33.95</b>

### Replacement Bulb

Z#	price
G2341001	<b>\$6.31</b>



## STREAMLIGHT Stinger C4 LED Rechargeable Flashlights

- Aluminum body
- 350/175/85 lm output  
310/219/155 m beam distance
- 3 light modes
- Water resistant
- NiMH/NiCad battery



Z#	switch	price
G3154042	head push button	<b>\$81.70</b>
G3395305	head/tailcap push button	<b>\$88.49</b>

## MAG-LITE Mini Tactical Flashlight

- Aluminum body
- Xenon beam
- 20,000 hr life
- 5 3/4" length
- includes (2) AA batteries*



Z#	color
G0172733	black
G3834731	blue
G3834713	red
G3834722	silver

each **\$14.27**

## STREAMLIGHT LED Keychain Flashlight

- Aluminum body
- 10 lm output
- 100,000 hr life
- 1 1/2" length
- includes (4) LR41 batteries*

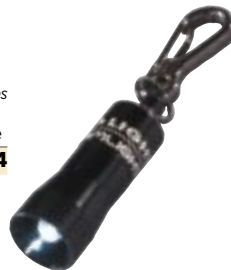

Z#	price
G3479174	<b>\$8.84</b>



## MAG-LITE XL Series LED Handheld Flashlights

- Aluminum body
- Polycarbonate lens
- Adjustable focus
- 4 7/8" length
- includes (3) AAA batteries*

Z#	lm output	beam distance	light modes	price
G2391024	139	145m	3	<b>\$32.33</b>
G4475834	172	138m	5	<b>\$34.79</b>



## MAG-LITE Ultrabright Mini LED Flashlights

- Aluminum body
- Polycarbonate lens
- 6 5/8" length
- includes (2) AA batteries*

Z#	lm output	beam distance	price
G4475825	226	140m	<b>\$36.68</b>
G4477103	245	150m	<b>\$38.06</b>



**STREAMLIGHT**  
**Inspection Pen Lights**

- Aluminum body
- Polycarbonate lens
- Bright LED beam
- Water & impact resistant
- 30,000 hr life

Z #	lm output	beam distance	AAA batteries	price
G2305527	35	38m	included (1)	<b>\$21.47</b>
G1302515	65	52m	included (3)	<b>\$17.92</b>

**WESTWARD**  
**Rechargeable LED Lantern**

- ABS body
- 200 lux
- 100 K hr life
- NiMH battery

includes AC/DC charger and car charger

Z #	price
G0781566	<b>\$61.21</b>



**FLUKE**  
**UV LED Leak Detector Flashlight**

- ABS body
- 3 light modes
- 395 nm wavelength
- 100,000 hr life

includes (3) AAA batteries

Z #	price
G2180385	<b>\$50.54</b>



**STANLEY**  
**Mini LED Tripod Flashlight**

- 8 lm output
- Shatter-resistant polycarbonate lens
- 100,000 hr life
- AAA batteries required (3), NOT included

Z #	price
G2915053	<b>\$13.10</b>



**ENERGIZER**  
**Industrial LED Headlights**

- ABS body
- Polycarbonate lens
- 4 light modes

includes (3) AAA batteries

Z #	lm output	beam distance	price
G1308151	36	25/35/37 m	<b>\$13.56</b>
G4875717	70	77'	<b>\$21.89</b>



**WESTWARD**  
**Rechargeable LED Lantern**

- ABS body
- 200 lux
- 100 K hr life
- NiMH battery

includes AC/DC charger and car charger

Z #	price
G0781566	<b>\$61.21</b>



**ENERGIZER**  
**Professional Hard Hat LED Headlight**

- ABS body
- Polycarbonate lens
- 70 lm output
- 4 light modes

Z #	price
G2658424	<b>\$28.19</b>



**BRINKMANN**  
**Dual LED Pivot Spotlight**

- ABS body
- 300 lm output
- 197 m beam distance
- 100,000 hr life

includes (6) AA batteries

Z #	price
G2702411	<b>\$29.93</b>



**BRINKMANN**  
**Rechargeable Sealed Beam Spot-Flood Light**

- Plastic body
- 200,000 high/100,000 low candle power
- 628 m beam distance
- 100 hr lamp life
- 1,395 lm output
- Black

includes 15' cord with lighter plug and magnetic base

Z #	price
G1053394	<b>\$64.82</b>

**COAST**  
**LED Focusing Headlights**

- Metal and plastic body
- Additional dimmer switch in back

includes (3) AAA batteries

196 LM Output				
Z #	beam distance	includes	price	
G1308151	109 m	sheath	<b>\$13.56</b>	

150 LM Output				
Z #	beam distance	includes	price	
G4875717	114 m	sheath, USB & AC chargers	<b>\$21.89</b>	



**PEAK**  
**Rechargeable LED Spotlight**

- ABS body
- 200 lm output

includes AC/DC adapter

Z #	price
G7509887	<b>\$27.28</b>



**BRINKMANN**  
**Rechargeable Halogen Spotlight**

- ABS body
- 11,000 lux output
- 2,000,000 candle power
- 12 V cord

includes AC/DC charger

Z #	price
G1281865	<b>\$43.71</b>





# ELECTRICAL

MORE THAN 800,000 ITEMS ONLINE

## RAYOVAC Lantern Batteries

- Mercury free

### Spring Terminal

Q#	voltage	type	price
G0299887	6	industrial	<b>\$1.87</b>
G0566115	6	heavy duty	<b>\$1.98</b>
G1261443	6	heavy duty maximum	<b>\$2.44</b>

### Screw Terminal

Q#	voltage	type	price
G3056584	6	industrial	<b>\$5.20</b>
G1723477	6	industrial	<b>\$8.03</b>
G1936803	7.5	multiple ignition	<b>\$21.47</b>
G0847217	7.5	alkaline	<b>\$24.88</b>
G3330512	12	industrial	<b>\$8.48</b>



## DURACELL Lantern Batteries

- Alkaline



Q#	terminal	voltage	price
G1456262	screw	6	<b>\$6.24</b>
G0990534	spring	6	<b>\$7.75</b>
G2330553	screw	7.5	<b>\$25.70</b>

## DURACELL Procell Alkaline Batteries

- Mercury free
- Date coded
- Does not expel energy when device is off

Q#	battery size	pack	price
G2916952	AAA	24	<b>\$6.89</b>
G2205445	AA	24	<b>\$6.27</b>
G1714386	C	12	<b>\$6.45</b>
G1166277	D	12	<b>\$8.39</b>
G2313832	9V	12	<b>\$16.86</b>



## ENERGIZER Alkaline Batteries

- 1.5V
- ANSI STANDARDS

Q#	battery size	price
G4552012	AAA	<b>\$14.28</b>
G5003783	AA	<b>\$9.56</b>
G4551951	C	<b>\$11.46</b>
G4553516	D	<b>\$12.16</b>



## VALUE BRAND Coin Cell Batteries

- 3V
- Lithium

Q#	battery size	price
G2048882	2032	<b>\$0.59</b>
G1568953	2450	<b>\$0.55</b>



## POWER FIRST Alkaline Batteries

- 1.5V
- Mercury free
- Date coded
- Suitable for flashlights, smoke detectors and multimeters

Q#	battery size	pack	price
G3729266	AAA	24	<b>\$14.93</b>
G4213964	AA	24	<b>\$14.93</b>
G1960621	C	6	<b>\$8.34</b>
G0409236	D	6	<b>\$8.98</b>



## DURACELL Button Cell Batteries

- Silver oxide
- 1.5V
- Can provide memory backup for small electronics and watches
- Mercury free

Q#	battery size	price
G2622706	303/357	<b>\$1.04</b>
G0895885	389/390	<b>\$0.79</b>
G2157994	384/392	<b>\$0.96</b>

## DURACELL Coin Cell Batteries

- 3V
- Lithium
- Mercury free
- ANSI STANDARDS

Q#	battery size	pack	price
G0250625	2016	1	<b>\$1.32</b>
G0268441	2450	1	<b>\$2.35</b>
G2232264	2032	2	<b>\$2.04</b>
G4566737	2032	4	<b>\$4.45</b>



## DURACELL Button Cell Battery

- Lithium
- 3V
- Size 1/3N

Q#	price
G0879103	<b>\$2.57</b>



**DUAL-LITE**  
Sealed Lead Acid Battery

- Male faston terminal connection
- 4.5 Ah capacity
- 6 V
- 1<sup>4</sup>/<sub>50</sub>" w x 1<sup>7</sup>/<sub>8</sub>" l x 3<sup>7</sup>/<sub>50</sub>" h



#	price
G3937367	<b>\$6.98</b>

**VALUE BRAND**  
Sealed Lead Acid Batteries

- ABS housing
- Male faston terminal connection



#	voltage	capacity	price
G2048146	12 V	12 Ah	<b>\$52.24</b>
G1783406	6 V	4.5 Ah	<b>\$12.54</b>
G3073287	6 V	4 Ah	<b>\$11.01</b>

**DURACELL**  
Procell Lithium Batteries

- 3 V
- Size 123
- ■ ANSI STANDARDS



#	pack	price
G3659336	12	<b>\$25.18</b>
G0279027	400	<b>\$1,007.43</b>

**SUREFIRE**  
Lithium Batteries

- 3 V
- Size 123 A



#	pack	price
G3536066	6	<b>\$17.57</b>
G3546663	12	<b>\$24.79</b>
G3521445	72	<b>\$147.57</b>

**STREAMLIGHT**  
Lithium Batteries

- 3 V
- Size 123



#	pack	price
G2483196	2	<b>\$3.89</b>
G2352253	12	<b>\$19.43</b>

**RAYOVAC**  
Precharged Rechargeable Batteries

- 1.2 V
- Nickel-metal hydride

**Batteries**

#	size	battery capacity	rechargeable up to	recharge time
G3359535	AA	1350 m Ah	500 times	16 hours
G1705812	D	3000 m Ah	300 times	24 hours

each **\$22.16**

**Charger**

#	for sizes	price
G6142114	AAA, AA, C, D, and 9 V	<b>\$24.60</b>



**VALUE BRAND**  
Lithium Battery

- 3 V
- Size: 1/3 N
- ■ ANSI/IEC STANDARDS



#	price
G2020304	<b>\$1.29</b>

**ENERGIZER**  
Rechargeable Batteries

- 1.2 V
- Nickel-metal hydride

**Batteries**

#	size	capacity	rechargeable up to	pack	price
G3174762	AA	2300 m Ah	250 times	4	<b>\$12.99</b>
G0648155	C	2500 m Ah	1000 times	2	<b>\$10.29</b>

**Charger**

#	for sizes	price
G1184181	AAA, AA, C, D, and 9 V	<b>\$26.36</b>



**ECO ALKALINES**  
Eco-Responsible Batteries

- 1.5 V
- Carbon free certified
- Disposable alkaline

#	size	pack	price
G4294455	AAA	4	<b>\$3.16</b>
G4294446	AA	4	<b>\$3.38</b>
G4294491	D	2	<b>\$3.83</b>



**DURACELL**  
Rechargeable Batteries

- 1.2 V
- Nickel-metal hydride

**Batteries**

#	size	capacity	rechargeable up to	pack	price
G5237032	AAA	800 m Ah	400 times	4	<b>\$11.88</b>
G5236971	AA	2400 m Ah	400 times	4	<b>\$12.45</b>

**Charger**

#	for sizes	price
G5237014	AAA and AA	<b>\$14.07</b>





# TEST INSTRUMENTS

## FLUKE

### Noncontact Voltage Testers

- Audible and visual indications
- Pushbutton switch
- 5" length
- CAT IV 1000 V safety rating

includes (2) AAA batteries and instructions

Z#	VAC range	qty per pack	price
G0343585	20 to 90	1	<b>\$24.32</b>
G2002104	90 to 1000	1	<b>\$26.20</b>
G0277261	90 to 1000	5	<b>\$119.95</b>



## ZIRCON

### Circuit Breaker Finder

- 277 VAC range
- For use on energized lines
- LED display
- 9V battery

includes lockable case, clips and blades, light socket and 120 VAC plug adapters and battery

Z#	price
G3669513	<b>\$146.09</b>



## GREENLEE

### Voltage Detectors

- Audible and visual indications
- Thumb switch
- 5" length
- CAT IV 1000 V safety rating

### Self Test Function

- Auto turn off
- 50 to 1000 VAC

includes (2) AAA batteries and instructions

Z#	price
G3315024	<b>\$13.60</b>



### Adjustable Sensitivity

- Identifies hot, neutral conductors
- 5 to 1000 VAC

includes 1 AAA battery and instructions

Z#	price
G0433876	<b>\$19.49</b>



## AMPROBE

### Analog Battery Tester

- 1.5 to 9V
- 7.5" w x 4" d x 1.5" h
- Compatible with 9V, AA, AAA, C, D, and 1.5V button type batteries

includes instructions

Z#	price
G0833987	<b>\$7.95</b>



## PHILIPS ADVANCE

### Ballast Checker

- 15' Range
- LED display
- Turns green if electronic ballast and orange if magnetic ballast

Z#	price
G2471217	<b>\$42.93</b>



## EXTECH Data Logger

- 32° to 122° F temperature range
- 10 to 90% relative humidity range
- 10 to 1100 hPA, 7.5 to 825.0 mmHG, 0.29 to 3248 inHG pressure range
- 3.1" w x 1.3" d x 5.2" h

includes (2) GB SD card, 6 AAA batteries, AC adaptor, mounting bracket and instructions

Z#	price
G4612666	<b>\$255.60</b>



## SUPCO

### Mini Temperature Data Logger

- -40° to 160° F temperature range
- 3V battery
- USB interface
- 3" w x 1.5" d x 0.5" h

includes required software

Z#	price
G0304044	<b>\$55.41</b>



## EXTECH

### Water Resistant Digital Stop Watch

- Multiline LCD display
- 12/24 hr clock operation
- Programmable alarm
- 2 split and lap times

Z#	price
G2520305	<b>\$16.92</b>



## EXTECH Electronic Coating Thickness Tester

- Ferrous and nonferrous metals base
- 0 to 49 measuring range
- 400 readings recording capacity
- USB interface

includes batteries, USB interface cable, software, calibration iron, calibration aluminum, precision standards, carrying case and instructions

Z#	price
G2001982	<b>\$259.99</b>



## DEFELSKO

### Standard Electronic Coating Thickness Gauge

- 0.5 to 40 mil measuring range
- 10,000 recording capacity
- 3' cord
- NIST calibration certification

Z#	price
G2507495	<b>\$1,795.11</b>



## EXTECH Digital Sound Level Meter Kit

- 35 to 130 dB range
- 31.5 to 8000 Hz range
- A and C frequency weighting
- 2000 count LCD display
- ANSI AND IEC TYPE 2 STANDARDS

Z#	price
G2511835	<b>\$439.99</b>



\$ prices subject to change



**SUPCO**

**Line Powered Megohmmeter**

- 500 VDC output test voltage
- 20 to 1000 M Ohm insulation resistance range
- LED display
- includes test leads with alligator clips and carrying case*



# price  
G0712695 **\$80.90**

**FLUKE**

**Battery Operated Megohmmeter**

- 50/100/250/500/100D VDC output test voltage
- 0 to 20 k ohms insulation resistance range
- Greater than 30V live circuit detection
- CAT III 1000V, CAT IV 600V safety ratings

*includes remote probe, test leads, test probes, alligator clips, meter boot, batteries and instructions*



# price  
G2224013 **\$494.96**

**FLUKE Digital Multimeters**

- 10 A max
- True RMS AC response
- LCD display

**600 V Max**

- 40 M Ohm max
- CAT III 600V safety rating
- **UL, CSA STANDARDS**

*includes test leads, battery and instructions*



# price  
G2271963 **\$159.95**

**1000 V Max**

- 50 M Ohm max
- CAT III 1000V, CAT IV 600V safety ratings
- **UL, CSA, TUV, VDE, EN STANDARDS**

*includes test leads, alligator clips, 9V battery (installed) and manual*



# price  
G1608652 **\$373.47**

**FLUKE**

**Meter Hanging Kit**

- Nylon/plastic
- includes 9" hook and loop strap, hook hanger, magnetic hanger and a general purpose hanger*



# price  
G1505682 **\$33.96**

**FLUKE**

**Digital Multimeter Kit**

- 10 A max
- 1000V max
- 50 M Ohm max
- CAT III 1000V safety rating

*includes test leads, alligator clips, temperature probe, magnetic hanging kit, yellow meter boot and soft case*



# price  
G2384733 **\$432.91**

**FLUKE**

**Digital Clamp On Meters**

- 2500 max AC A, 999.9 max DC A
- 1000 max V, 60,000 max ohms
- CAT IV 600V, CAT III 1000V safety ratings
- **IEC, EN STANDARDS**

*includes flexible current probe, test leads, batteries, soft carrying case and instructions*

# price  
G2561377 **\$368.45**

**Remote Display**

# price  
G3234052 **\$449.96**



**FLUKE**

**Split Jaw Meter**

- 600V max, 100A max, 1000 max ohms
- 1/2" jaw capacity
- CAT III 600V safety rating
- **EN, UL, CSA, TUV STANDARDS**

*includes 4 mm detachable probes and instruction sheet*



# price  
G0268256 **\$118.19**

**FLUKE**

**Electrician's Digital Multimeter**

- 600V max, 10 A max
- 40 max M Ohm
- CAT III 1000V safety rating
- **UL, CSA, CE, VDE STANDARDS**

*includes test leads, battery and instructions*



# price  
G0296484 **\$167.19**

**AMPROBE ACD-14 Plus Clamp-On Digital Multimeter**

- 600 max A and V
- 40 M Ohm
- 1" jaw capacity
- CAT III 600V safety rating
- includes test leads, battery (installed), soft carrying pouch, bead thermocouples with banana plug and manual*



# price  
G1115283 **\$129.95**

**FLUKE**

**Digital Clamp On Meter**

- 600 max A and V
- 6000 max ohms
- 1 1/16" jaw capacity
- CAT IV 600V, CAT III 1000V safety ratings
- **IEC, EN STANDARDS**
- includes TL 76 test leads, batteries, soft carrying case and instructions*



# price  
G2140065 **\$269.96**

**FLUKE**

**Digital Clamp On Ammeter**

- 600 max AC A, 200uA max DC A
- 600 max V, 9999 M Ohm
- 1 1/4" jaw capacity
- CAT III 600V safety rating
- includes manual with safety information, soft carrying case, test leads and an integrated DMM temperature probe*



# price  
G2106851 **\$269.96**



# TEST INSTRUMENTS

## FLUKE

### Class II Laser Infrared Thermometer

- -40° to 1202°F, -40° to 650°C temperature range
  - 30:1 focus spot size, single dot laser sighting
  - 8 to 14 μm spectral response
  - Dot matrix LCD display
- includes thermocouple K bead probe, hard case, getting started guide and users manual*

**Z#** price  
**G1872507 \$278.96**



## TAYLOR

### Digital Food Service Thermometer

- -4° to 158°F, -20° to 60°C temperature range
- LCD display with 3/4" digit size
- Plastic stem
- Metal detectable
- For use with refrigerators/freezers

**Z#** price  
**G3286281 \$8.13**



### TAYLOR Pro Waterproof Instant Read Thermometer

- -40° to 450°F, -40° to 230°C temperature range
  - 5" stem, 1" dial
  - 4 digit LCD
  - **NSF CERTIFIED**
- includes anti-bacterial sleeve, battery and instructions*

**Z#** price  
**G1117767 \$8.74**



## MILJOCO

### Bimetal Analog Dial Thermometer

- 0° to 250°F, -20° to 120°C temperature range
- Stainless steel with polycarbonate window
- 2" dial size, 2 1/2" stem, 1/4" stem diameter
- 1/4" NPT
- Hermetically sealed case

**Z#** price  
**G3160805 \$10.75**



### TAYLOR Classic Instant Read Pocket Thermometer

- -40° to 392°F, -40° to 150°C temperature range
  - Stainless steel with plastic case and lens
  - 4 3/4" stem, 0.4" LCD display, 1 1/4" dial size
  - **NSF CERTIFIED**
- includes battery, rubber boot and instructions*

**Z#** price  
**G0712397 \$7.73**



## TAYLOR

### High Temperature Digital Thermometer

- -40° to 500°F, -40° to 260°C temperature range
  - Stainless steel with plastic case and lens
  - 4 3/4" stem, 0.4" LCD display, 1 1/4" dial size
  - **NSF CERTIFIED**
- includes battery and instructions*

**Z#** price  
**G3140715 \$8.36**



### TAYLOR Commercial Digital Refrigerator/Freezer Thermometer

- -4° to 140°F, -20° to 60°C temperature range
  - LCD display with 5/8" digit size
  - For use with refrigerators/freezers
- includes foldable hanger and Li-Ion battery*

**Z#** price  
**G4038167 \$5.54**



## TAYLOR

### Rain Gauge

- 0 to 5" range
- 0.1" graduations
- 12.5" h
- 2 keyhole mount
- Polycarbonate

**Z#** price  
**G2090261 \$6.60**



### EXTECH Temperature and Humidity USB Data Logger

- -40° to 158°F temperature range
  - 0 to 100% RH
  - 5.1" w x 0.9" d x 1.1" h
  - LED status indicators
- includes 3.6V lithium battery, protective USB cap, Windows compatible software and instructions*

**Z#** price  
**G1752685 \$80.99**



## BACHARACH

### Sling Psychrometer

- 25° to 120°F temperature range
- Red spirit liquid fill

## Psychrometer

- 10 to 100% RH
  - Thermometer case telescopes into handle
  - Dual range
- includes instructions*

**Z#** price  
**G1810846 \$41.99**



## Replacement Thermometer

**Z#** price  
**G0291121 \$28.43**

## EXTECH

### Pinless Moisture Meter

- IR thermometer
  - -20° to 170°F temperature range
  - -4° to 392°F infrared temperature range
  - 0 to 99% moisture content, 10 to 95% RH
  - For use with wood or building materials
- includes pin type moisture probe, battery and instructions*

**Z#** price  
**G0361426 \$579.00**



**MICRO ESSENTIAL  
Hydriion Spectral  
Plastic pH Test Strips**

- 1/4" x 2 3/4"
- 100 pack

Item #	pH range
G4029453	0 to 14
G3979132	5.5 to 8
G4144831	0 to 6
G4174834	5 to 9
G3940991	6.5 to 13

each **\$13.81**



**MICRO ESSENTIAL  
Hydriion pH Paper Dispenser**

- 1.0 to 12.0 pH range
- 75 tests

Item #	price
G3933045	<b>\$6.15</b>



**OAKTON  
Waterproof EcoTester 2**

- 0.00 to 14.00 pH range
- 0° to 50° C displayed temperature range
- Single line LCD display
- 1, 2, or 3 point calibration

Item #	price
G4167204	<b>\$52.29</b>



**HANNA INSTRUMENTS  
Waterproof pH Tester**

- 0.00 to 14.00 pH range
  - 32° to 140° F operating temperature range
  - 1 or 2 point calibration
  - Dual line LCD
- includes pH electrode, pH electrode removal tool and batteries

Item #	price
G4037117	<b>\$69.36</b>



**LAMOTTE  
Multi-Test Colorimeter Pool Kit**

- 6.5 to 8.5 pH range
  - 0.1 pH resolution
  - 0 to 10 PPM total chlorine
  - 0.1 PPM chlorine resolution
- includes reagents for (144) tests, reagents for (50) cyanuric acid tests, sample vials, batteries, carrying case and instructions

Item #	price
G0856274	<b>\$137.99</b>



**EXTECH  
Waterproof Ex Stick pH Meter**

- 0.00 to 14.00 pH range
  - 23° to 194° F, -5° to 90° C operating temperature range
  - Dual line LCD display
  - 1, 2, or 3 point calibration
- includes built-in smart chip which predicts PH electrode performance with RENEW indicator

Item #	price
G2936211	<b>\$74.79</b>



**HANNA INSTRUMENTS  
pH Tester**

- 0.00 to 14.00 pH range
  - Single line LCD display
  - 1 point calibration
- includes combination pH electrode, replaceable screw-type and battery

Item #	price
G2784555	<b>\$26.82</b>



**DICKEY-JOHN  
Soil Compaction Tester**

- 0 to 500 psi range
  - 30" long
  - 1/2" and 3/4" probe diameter
  - Steel
- includes (2) tips and instructions

Item #	price
G2673946	<b>\$234.75</b>



**LAMOTTE  
Model EL Garden Test Kit**

- 4 to 8 pH range
- includes laminated color charts, labware, stable reagents, instructions and (2) booklets

Item #	price
G4615527	<b>\$54.83</b>



**AMS  
Soil Recovery Probes**

- 4130 alloy steel
- 5/8" thread

Step	price
• 40" long	
• 1/2" diameter	
• Nickel plated	
Item #	price
G2151755	<b>\$79.56</b>



Regular	price
• 33" long	
• 3/8" diameter	
• Unplated	
includes probe body and 10" cross handle	
Item #	price
G3096931	<b>\$57.04</b>

**LAMOTTE  
Soil Sampler**

- 1" diameter
  - Saw toothed tip
  - Cutaway side for core viewing
  - Galvanized steel
- includes (20) soil sampling bags

Item #	price
G0297857	<b>\$28.85</b>



**LAMOTTE  
Water Test Education Kit**

- Colorimetric
  - 10 tests
  - For pH, dissolved oxygen, nitrate, phosphate, coliform bacteria and temperature turbidity test types
- includes reagents and accessories for (10) tests

Item #	price
G4100975	<b>\$37.88</b>





# TEST INSTRUMENTS

## BACHARACH Informant 2 Combustible and Refrigerant Gas Detector

- Audible and visual indicator
- Flashing probe tip
- Automatic sensitivity
- **INTRINSICALLY SAFE FOR USE IN CLASS 1 DIVISION 1, GROUP D LOCATIONS**

*includes batteries, refrigerant and combustible gas sensors, color-coded probe tips, hard carrying case and instructions*

**Z#** price  
G1923467 **\$363.45**



## BACHARACH Leakator Jr Combustible Gas Leak Detector

- Audible and visual indicator
- Auto calibration
- **UL LISTED INTRINSICALLY SAFE CLASS 1 DIVISION 1 GROUPS A, B, C, D**

*includes sensor tip, batteries, fabric case and instructions*

**Z#** price  
G0277182 **\$157.73**



## AMPROBE Combustible Gas Detector

- Audible and visual indicator
- Detects methane and propane
- **CE STANDARDS**

*includes batteries and instructions*

**Z#** price  
G2036912 **\$147.70**



## AMPROBE Handheld Carbon Dioxide Meter

- 0 to 9999 PPM CO<sub>2</sub> concentration
  - 14° to 140° F temperature range
  - 0 to 95% RH Range
  - Triple line LCD display
- includes batteries, hard carrying case and instructions*

**Z#** price  
G2699724 **\$314.96**



## GENERAL Natural Gas Detector

- Audible and 3-color LED indicators
  - Adjustable sensitivity
- includes gas detector and battery*

**Z#** price  
G1547515 **\$184.99**



## GENERAL Combustible Gas Detector Pen

- Audible and LED indicators
- Catalytic combustion sensor
- Calibrated
- Detects liquid natural gas, propane (LPG), methane and butane

*includes pen, wrist strap and (2) AA batteries*

**Z#** price  
G3953747 **\$36.92**



## BACHARACH Smoke Tester Kit

- Provides reading time in less than a minute
- includes pump, scale and filter paper*

**Z#** price  
G3265403 **\$97.35**



## EXTECH EzFlex Combustible Gas Detector

- Audible and visual indicator
  - 16" flexible gooseneck
- includes (3) batteries and instructions*

**Z#** price  
G1592577 **\$116.99**



## BACHARACH Oxygen Analyzer Kit

- 0 to 20.9% oxygen concentration
  - 0.1% resolution
  - 4 digit LCD display
- includes probe and hose assembly, IR printer and paper, batteries, hard carrying case and instructions*

**Z#** price  
G1681391 **\$755.28**



## FLUKE Soft Carrying Cases

- Polyester
- Weather resistant zipper
- Yellow/black

### C35 Soft Carrying Case

- 5½" w x 2½" d x 8½" h
- includes strap*

**Z#** price  
G2465915 **\$20.88**



### C115 Soft Carrying Case

- 7" w x 9" d x 2" h
- 2 padded pockets

**Z#** price  
G3058571 **\$24.20**



### C116 Soft Carrying Case

- 8¾" w x 8¾" d x 2" h
- Adjustable padded space with a moveable divider

**Z#** price  
G3326005 **\$29.48**



## FLUKE T5-1000 Tester Kit

*includes T5-1000 electrical tester, AC-III VoltAlert and H5 holster*

**Z#** price  
G1616553 **\$167.64**



**FLUKE Hard Point Test Lead Set**

- 10 max A, 1000 VAC max
- PVC wire insulation
- 48" long
- Test leads with right angle shrouded banana plugs
- CAT IV 600V and CAT III 1000V safety rating
- ■ UL STANDARDS

Q # price  
G3377464 **\$21.52**



**FLUKE SureGrip Insulated Test Leads**

- 10 max A
- Silicone wire insulation
- 59" long
- Standard diameter banana plugs and right angle connector on one end and straight connector on the other
- CAT IV 600V and CAT III 1000V safety rating,
- ■ UL STANDARDS

Q # price  
G2041173 **\$24.95**



**GENERAL Jumper Lead Kit**

- 22 AWG wire gauge
- 18" long
- 300V rating
- Features shielded alligator clips on both ends
- 2 cords of each color — white, red, black, yellow and green

Q # price  
G2042573 **\$7.46**

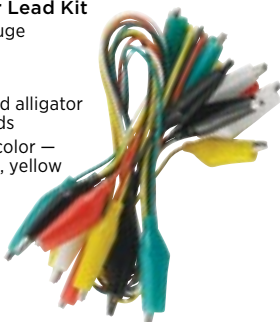

**DURO Water Pressure Test Gauge**

- Steel case with copper alloy socket and acrylic lens
- 0 to 160 psi range
- 2" dial
- 3/4" female hose thread connection

Q # price  
G4715085 **\$9.77**



**HANNA INSTRUMENTS Calibration Solution**

- 4.01 pH range
- 500 mL plastic bottle
- For use with meters and testers

Q # price  
G4203726 **\$12.28**



**VALUE BRAND Test Vacuum Gauges**

- ABS case with brass socket and acrylic lens
- 30 to 0" Hg VAC and -100 to 0 kPa range

Q #	dial size	NPT connection	price
G0044922	1 1/2"	3/8" back	<b>\$4.17</b>
G0044755	1 1/2"	3/8" bottom	<b>\$8.69</b>
G0045507	2"	1/4" back	<b>\$4.85</b>
G0045333	2"	1/4" bottom	<b>\$8.79</b>



**VALUE BRAND Test Pressure Gauges**

- ABS case with brass socket and acrylic lens
- 0 to 160 psi and 0 to 1100 kPa range

Q #	dial size	NPT connection	price
G0044983	1 1/2"	3/8" back	<b>\$4.19</b>
G0045561	2"	1/4" back	<b>\$4.85</b>



**VALUE BRAND Liquid Filled Pressure Gauges**

- ABS case with brass socket and acrylic lens
- 1/4" NPT back connection
- 2" dial size

Q #	psi	kPa
G0038753	0 to 100	0 to 700
G0038762	0 to 160	0 to 1100
G0038771	0 to 200	0 to 1400

each **\$12.39**



**ASHCROFT 1005P Series Sprinkler System Pressure Gauge**

- 0 to 300 psi range
- 3 1/2" dial size
- 1/4" NPT connection
- ABS case with brass socket

Q # price  
G0418135 **\$12.67**



**ENERPAC Liquid Filled G Series Pressure Gauge**

- 0 to 10,000 psi range
- 2 1/2" dial size
- Calibrated with a bottom connection
- 1/4" MNPT connection
- includes safety blowout disc and pressure equalizing membrane*

Q # price  
G0446871 **\$87.23**



**IMPERIAL Service Manifolds and Gauges**

- For use with air conditioning and stationary refrigeration
- Pulsation resistant gauges
- 60" hose length
- ■ UL STANDARDS

**400 Series**

- 2 brass valves
- 3 hoses

Q # price  
G2128472 **\$90.65**



**600 Series**

- 4 aluminum valves
- 4 hoses
- 3/8" vacuum port

Q #	high side red gauges	low side blue gauges	price
G2076855	0-800 psi	30" Hg to 350" psi	<b>\$165.73</b>
G1863784	0-800 psi	30" Hg to 500" psi	<b>\$167.12</b>



**LAB SAFETY SUPPLY Buffer Solutions**

- pH standard
- NIST traceable
- 500 mL plastic bottle
- For use with pH meters and electrodes

Q #	pH range
G3954851	7.00 +/- 0.01
G4151393	4.00 to 4.01
G3917015	10.00 +/- 0.02

each **\$14.88**





## TEST INSTRUMENTS

### KIMBLE CHASE Glass Beaker Starter Kit

- 50, 100, 250, 600 and 1000 mL capacity beakers
- 10, 10, 10, 25 and 50 mL graduation subdivisions
- Type 1
- Durable matte finish marking area
- ■ ASTM E960-1997 STANDARDS

Z#	price
G3931216	<b>\$28.52</b>



### BEL-ART-SCIENCEWARE

#### Space Saver Vacuum Desiccators

- Polycarbonate top with polypropylene bottom

Z#	size	diameter	price
G4655463	5 7/8" x 8 1/4"	6 3/4"	<b>\$45.89</b>
G4688047	9 7/8" x 12 1/2"	10 1/4"	<b>\$114.99</b>



### VALUE BRAND Straight Bore Glass Burette

- 50 mL capacity
- 0 to 50 mL graduation range with 0.1 mL graduation subdivisions
- Class A
- 860 mm long
- 4 pack

Z#	price
G1283581	<b>\$50.64</b>



### VALUE BRAND Low Form Glass Beaker

- 5000 mL capacity
- 1000 mL graduation subdivisions

Z#	price
G0905703	<b>\$26.37</b>



### VALUE BRAND Mortar and Pestle

- Porcelain

Z#	size	inner dia	price
G4168455	80 mL	60 mm	<b>\$2.90</b>
G4109682	125 mL	75 mm	<b>\$3.45</b>
G4160712	300 mL	100 mm	<b>\$4.05</b>
G4156582	500 mL	125 mm	<b>\$4.83</b>



### VALUE BRAND Separatory Glass Funnel

- 1000 mL capacity
- Polyethylene stopcock
- includes a PTFE key and stopcock and a polyethylene stopper

Z#	price
G4720782	<b>\$34.93</b>



### HEATHROW SCIENTIFIC Wire Drying Rack

- Vinyl coated steel wire
- 7 1/8" w x 20 3/4" d x 18 1/4" h

Z#	price
G3942836	<b>\$76.07</b>

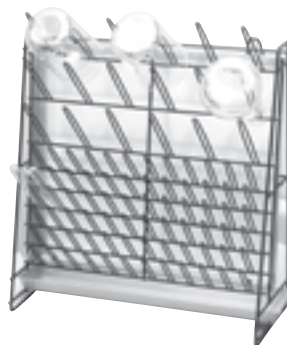

### VALUE BRAND Plastic Jug

- 1 gal capacity
- 6" w x 6" d x 11 1/2" h
- 1 1/2" closure
- includes threaded cap

Z#	price
G1646583	<b>\$3.07</b>



### VALUE BRAND Disposable Polypropylene Beakers

- 100 mL capacity
- 5 mL and 1/2 oz molded graduation subdivisions
- Translucent
- 100 pack

Z#	price
G4204882	<b>\$32.90</b>



### VALUE BRAND Standard Spout LDPE Wash Bottles

- 16 oz capacity
- Wide mouth
- Polypropylene cap
- Non-vented
- 230 mm height and 72.1 mm diameter

#### Clear Cap

Z#	price
G1944415	<b>\$2.91</b>

#### Color Caps

Z#	color
G2539311	blue
G0797282	red
G3043957	yellow
G3408702	green

each **\$3.12**



### VALUE BRAND Glass Vial

- 4 mL capacity
- Polypropylene closure
- Clear, blue cap
- 144 pack

Z#	price
G4008085	<b>\$45.85</b>



### VALUE BRAND Glass Vials Scintillation

- 20 mL capacity
- Polypropylene closure
- 100 pack
- includes cap

Z#	price
G3887493	<b>\$35.43</b>



### KIMBLE CHASE Glass Beakers

- Low form
- White graduated scale
- ■ ASTM E960 STANDARDS
- includes matte finish marking area

Z#	capacity	subdivisions	qty per pack	price
G4015891	250 mL	25 mL graduation	12	<b>\$38.58</b>
G4226957	600 mL	50 mL graduation	6	<b>\$25.00</b>
G4036602	1000 mL	50 mL graduation	6	<b>\$46.00</b>



**HEARTHROW SCIENTIFIC Dropper Bulbs**

- Rubber
- 52 mm
- 2 mL range
- 72 pack



#	price
G4676217	<b>\$18.81</b>

**KIMBLE CHASE Volumetric Pipette**

- Glass
- 505 mm length
- 25 mL capacity
- 0.03 mL tolerance
- 6 pack



#	price
G3922931	<b>\$86.69</b>

**DRAGONLAB Linear Pipette Stand**

- ABS
- 14 cm w x 28 cm l x 27½ cm h
- Holds 6 pipettes



#	price
G4692624	<b>\$33.08</b>

**HEARTHROW SCIENTIFIC Safety Bulb Pipette Filler**

- Silicon
- 15 mL
- 3 pack



#	price
G4228655	<b>\$11.53</b>

**HANNA INSTRUMENTS Mini Magnetic Stirrer**

- ABS housing
  - 100-1000 rpm with Speedsafe
  - 5" x 5" plate
  - 1 L max stirring capacity
- includes stir bar and instructions*



#	price
G4057322	<b>\$83.59</b>

**NICHIRYO Graduated Pipette Tips**

- Resin
- 2 to 200 uL range
- 1000 pack



#	price
G4663784	<b>\$15.68</b>

**VALUE BRAND Grade B Measuring Pipette**

- Glass
- 330 mm length
- 10.00 mL capacity
- 0.1 mL tolerance and graduation subdivisions
- 12 pack

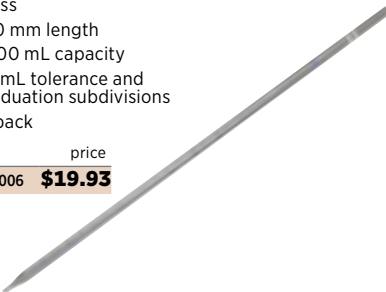

#	price
G1215006	<b>\$19.93</b>

**VALUE BRAND Pipette Pump**

- Plastic
- 25 mL



#	price
G4052982	<b>\$13.53</b>

**CAFRAMO 1/100 HP Ultra Compact Digital Overhead Stirrer**

- Stainless steel and molded nylon
- 2.1" w x 6.2" l x 5.1" h
- 2 L volume
- 50 to 2500 rpm, 100 to 240 V

*includes stand, (2) mixing blades, mixing shaft, power supply and universal adapter*



#	price
G4818414	<b>\$391.90</b>

**AIR-TITE Reusable Glass Syringes**

- For use with sharp, tri-bevel needles

**Metal Luer Lock**

#	size	price
G4824154	1 mL	<b>\$11.47</b>
G4824172	3 mL	<b>\$11.65</b>
G4824181	5 mL	<b>\$11.82</b>
G4822763	10 mL	<b>\$11.99</b>

**Glass Luer**

#	size	price
G4824075	1 mL	<b>\$8.79</b>
G4822754	3 mL	<b>\$8.89</b>
G4824093	5 mL	<b>\$8.99</b>
G4824102	10 mL	<b>\$9.99</b>



**NORM-JECT Luer Slip Plastic Syringes**

- Polypropylene body
- Polypropylene and polyethylene tip
- For use with sharp, tri-bevel needles
- Green plunger
- 100 pack

#	size	price
G4823962	1 mL	<b>\$16.33</b>
G4823996	2 mL	<b>\$17.47</b>
G4824014	5 mL	<b>\$18.61</b>



**VALUE BRAND Glass Stirring Rod**

- 1/8" x 6"
- 12 pack

#	price
G4168202	<b>\$1.80</b>





# FANS & HVAC



## TOP BRANDS



**BLOWERS**

pg 113

**ELECTRIC HEATERS**

pg 116

**GAS HEATERS**

pg 117

**DUCTS**

pg 118

**VENTING**

pg 119

**THERMOSTATS**

pg 120

**AIR CONDITIONING**

pg 123

**VENTILATORS**

pg 127

**INDUSTRIAL FANS**

pg 128

**MOTORS**

pg 131



**DRI-EAZ**

**Portable Blower Fan**

- Rotomolded polyethylene housing
- Carpet drying, floor drying and confined space ventilating
- 2041 cfm
- 18¾" w x 15¾" l x 19¼" h
- 20' power cord
- 115V

# price  
G1495243 **\$615.00**



**DRI-EAZ Extension Duct**

- PVC coated polyester
- Directs warm air into confined spaces
- Semi rigid
- 300" long, 12" OD
- For use with G1495243

# price  
G1795726 **\$289.00**



**AIR KING**

**Pivoting Portable Blower Fan**

- ABS plastic housing
- 250/300/350 cfm
- 11" w x 13" l x 14½" h
- 120V

*includes permanently lubricated ball bearings and (2) grounded courtesy 120V 10A outlets, SO type black 7' power cord, 7" x 7" blade and side mounted rotary dial switch*

# price  
G3251132 **\$120.46**

**DRI-EAZ**

**3 Speed Carpet/Floor Dryer**

- Rotomolded polyethylene housing
- 1900/2400/2700 cfm
- 17" w x 18¼" l x 18⅞" h
- 25' power cord
- 115V

*includes carpet clamp*

# price  
G0763734 **\$365.00**



**METRO**

**Compact Industrial Blower**

- All steel housing
- 180 cfm
- 12' power cord
- 120V

*includes flexible 1½" x 10' hose, neoprene blower/nozzle and foam filter*

# price  
G1909232 **\$278.13**

**DAYTON**

**Carpet/Floor Dryer**

- Polypropylene housing
- 200/300/500 cfm
- 9½" w x 12¾" l x 13¾" h
- 10' power cord
- 120V

*includes (2) grounded courtesy 120V 5A outlets*

# price  
G1644571 **\$105.87**



**DAYTON**

**Carpet/Floor Dryer**

- Polypropylene housing
- 869/1648 cfm
- 17" w x 18" l x 19⅞" h
- 25' power cord
- 120V

# price  
G2503715 **\$359.50**



**DAYTON**

**Carpet/Floor Dryer**

- Polypropylene housing
- 1000/1300/1600 cfm
- 15¾" w x 20½" l x 38" h
- 30' power cord
- 120V

*includes telescopic transport handle with caution banner*

# price  
G1769372 **\$406.08**



**TORNADO**

**Downdraft Carpet/Floor Dryer**

- Plastic housing
- 2100/3500 cfm
- 16" propeller
- 18" w x 28" l x 25" h
- 20' power cord
- 115V

*includes telescopic handle and wheels and 360° high-velocity airflow*

# price  
G2658695 **\$543.90**



**POWER CAT**

**Portable Blower Fan**

- Powder coated steel housing
- 877/1120 cfm
- 11⅞" w x 17½" l x 20⅞" h
- 25' power cord
- 120V

*includes wooden grip, duplex 15A weather resistant grounded electrical outlets and 14 ga cord*

# price  
G1099357 **\$299.99**

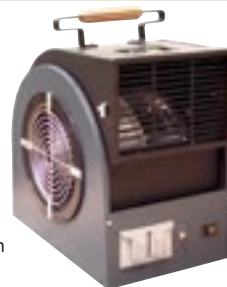

**TORNADO**

**Portable Blower Fan**

- Polyethylene housing
- 2400/3400 cfm
- 16½" w x 22" l x 11½" h
- 0°/20°/90° air flow direction
- 20' power cord
- 120V

# price  
G5160836 **\$210.56**





# FANS & HVAC

## AIR KING Portable Pivot Fans

- Polypropylene blades
- Impact resistant plastic guards
- Non-oscillating
- 6' power cord
- 3-speed
- 120V

includes carrying handle and rotating fan head

Z#	dimensions	price
G1377871	6¾" w x 13" l x 13¼" h	\$28.31
G0276534	6¾" w x 23¾" l x 23¾" h	\$42.00



## AIR KING Wall Mount Fans

- Impact resistant plastic and steel guards
- Polypropylene blades
- 3-speed
- 120V
- 6' power cord

includes tilting head, pull cord switch and mounting hardware

Z#	blade dia	dimensions	price
G2702481	12"	14¾" w x 15¾" l x 20¾" h	\$34.83
G2383911	16"	14" w x 18" l x 22¾" h	\$39.68
G0584473	18"	15½" w x 20¾" l x 23" h	\$43.89



## DAYTON Portable Box Fan

- Steel and aluminum blade
- Impact resistant metal grill
- 3-speed
- 10' power cord
- 7¾" w x 21¼" l x 23½" h

Z#	price
G6102993	\$113.17



## DAYTON Non-Oscillating Table Fan

- 2-speed
- 9.6VDC
- 7¼" w x 6¾" l x 11¼" h
- ■ UL LISTED

includes battery charger

Z#	price
G4116445	\$68.52



## AIR KING Oscillating Table Fans

- Polypropylene blades
- Tilting head
- 6' power cord
- 120V

Z#	blade dia	speed	dimensions	price
G3100343	9"	2	8¾" w x 11¾" l x 16¾" h	\$30.40
G1967777	12"	3	10½" w x 14" l x 19" h	\$33.88
G1358971	16"	3	12" w x 17¾" l x 22¾" h	\$35.67



## AIR KING Widow Fan

- White plastic
- Fits window height 22"
- Fits window width 26½" to 34½"
- 3-speed
- 120V

includes rotary control knob, extender side panels and exclusive storm guard feature

Z#	price
G0842457	\$84.89

## AIR KING Clip On Fan

- 6" polypropylene blade
- 2-speed
- Steel/plastic guard
- 6' power cord
- 120V

Z#	price
G1492897	\$16.53



## AIR KING Table Fan

- 3" polypropylene blade
- 2-speed
- 6' power cord
- 120V
- 5½" w x 7" l x 6½" h

Z#	price
G3184641	\$29.54



## AIR KING Portable Box Fan

- 20" blade
- 3-speed
- 120V
- 6' power cord
- 6¾" w x 21¾" d x 22½" h

Z#	price
G3328683	\$28.28



## AIR KING Whole House Window Mount Fan

- Fits windows 27" to 38" w x 26¾" h
- Steel housing and 20" propeller
- 3-speed/reversible
- 2510/3120/3560 low, med, hi cfm
- 120V

Z#	price
G3136716	\$141.72



## AIR KING Window/Table Fan

- White plastic finish
- 7" blades
- 120V
- 21¾" w x 4¼" d x 10¾" h

includes snap on feet for table, or floor use

Z#	price
G2451443	\$54.97

## AIR KING Pedestal Fans

- Powder coated steel front with high impact resistant plastic rear guard
- 18" polypropylene blades
- Column height adjustment from 37" to 53¾"
- 1950/1680/1380 cfm
- Head tilting adjustment 30° up to 15° down
- 120V

Z#	color	price
G1647256	white	\$42.92
G1423861	gray w/remote	\$62.50





**BROAN**

**Bath Fan Upgrade Kit**

- Cuts sound levels up to 50% and boosts air movement up to 20%
  - Use with Broan models 670, 671, 688, 689, Nautilus models N671, N688 with housings 7½" x 7¼"
  - 9¾" w x 11½" d x 5" h
- includes fan motor and blower assembly, (2) motor plates, wrench, fasteners and white plastic grille*

#	price
G2325111	\$28.37



**BROAN**

**Bathroom Fan Finish Kit**

- Matte white polymeric grille
- 70 cfm @ 0.100-in SP
- 4.0 sonos @ 0.100-in SP @ 5 ft
- 1300 heat watts
- 120 V

*includes fan/heater/light assembly and grille*

#	price
G0580587	\$65.58

**BROAN Bathroom Fan/Heaters**

- White polymeric grilles
- 70 cfm @ 0.100-in SP
- 3.5 sonos @ 0.100-in SP @ 5 ft
- 26 ga steel housing
- 120 V

• **UL LISTED, HVI CERTIFIED**

*includes easy-to-mount 4-point adjustable mounting brackets, white polymeric grilles, 4" round duct outlet, quiet plastic damper and squirrel-cage plastic blower wheel*

**1-Bulb Heater**

- Requires one 250 W R40 infrared lamp (250R40/10)
- 10½" x 10¼" grille
- 8¾" w x 8¼" l x 6¾" h housing

#	price
G0984042	\$35.65



**2-Bulb Heater**

- Requires 2 x 250 W R40 infrared lamp (250R40/10)
- 10½" x 15¾" grille
- 8¾" w x 14¼" l x 6¾" h housing

#	price
G3163754	\$57.71



**BROAN**

**Decorative Bathroom Fan**

- Galvanized steel housing with satin nickel grille
- 70 cfm @ 0.100-in SP
- 3.5 sonos @ 0.100-in SP @ 5 ft
- 120 V
- Requires 2 x 60 W Incandescent lamps (60A15CA/C/CF-CD2)

*includes mounting ears to attach to ceiling joist and duct connector with damper*

#	price
G0254064	\$82.91



**BROAN**

**Through Wall Exhaust Fans**

- Steel housing with plastic grille
- Adjustable housing length 4¼" to 9½"
- 14½" x 14¼" housing
- 120 V

*includes back draft damper and weather hood*



#	duct size	cfm	sones	HVI	grille size	price
G0571803	8¾"	100	6.5		11½" x 11½"	\$50.53
G2783907	10¾"	270	6.0		13½" x 13½"	\$119.85

**BROAN**

**Bath/Kitchen Exhaust Fans**

- Steel housing with plastic grille
- Adjustable mounting brackets
- 7" housing height
- 120 V



#	duct size	cfm	sones	HVI	grille size	price
G1714255	8"	180	6.5		11½" x 11½"	\$57.40
G0317721	10"	350	6.5		13½" x 13½"	\$85.13

**BROAN Kitchen Exhaust Fan**

- 286 cfm @ 0.000-in SP
- 3.0 sonos @ 0.100-in SP @ 5 ft
- 12¼" w x 12¼" d x 11¾" h housing
- 120 V

*includes permanently lubricated motor, automatic back-draft damper and duct connector*

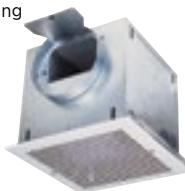

#	price
G2215376	\$178.24

**BROAN**

**Ceiling Mount Bathroom Fans**

- 26 ga galvanized steel housing
- Matte white polymeric grille
- 10¾" x 11½" grille
- 8" w x 8¼" l x 5¾" h housing

*includes brackets for mounting to ceiling joist or wall stud, round damper and duct connector*



**Lighted**

- Requires 100 W incandescent lamp (100 A-120 V)

#	cfm	sones	price
G2686047	50	2.5	\$28.92
G2419952	70	3.5	\$36.90

**Non-Lighted**

#	cfm	sones	price
G2563321	80	2.5	\$45.07

**BROAN Ceiling Mount Bathroom Fans**

- White polymeric grille
  - 120 V
  - 70 cfm @ 0.100-in SP
  - 4.0 sonos @ 0.100-in SP @ 5 ft
  - 10¾" x 16¾" grille
  - 8¼" w x 14¼" l x 5¾" h housing
- includes steel mounting brackets*

**Lighted**

- Requires 100 W incandescent lamp (100 A-120 V)

#	price
G2608286	\$64.97

**Lighted with Fan Forced Heater**

- Requires 100 W incandescent lamp (100 A-120 V)

#	price
G0368891	\$65.70

**Fan Forced Heater**

#	price
G0490883	\$105.19



**BROAN**

**Losone Ceiling Ventilators**

- For general ventilation applications
- Galvanized steel housings with metal grilles
- Ceiling or wall mount
- 120 VAC

*includes automatic backdraft damper*

**Square**

#	cfm	sones	amp	watt	motor rpm's	price
G0891335	231	1.6	1.80	127	740	\$95.97
G1712051	272	2.1	2.1	166	830	\$96.70

**Rectangular**

#	cfm	sones	amp	watt	motor rpm's	price
G2892495	480	2.0	1.4	146	735	\$157.52
G2738802	722	4.5	2.90	313	960	\$195.74

**BROAN Rotary Speed Controls**

- For all Broan fans with appropriate amp rating except ceiling paddle fans
- Built-in noise suppressor
- Adjustable
- 120 V
- **UL LISTED**



#	color	amp max	watt max	dimensions	price
G1539842	ivory	3	360	1¾" w x 1½" d x 4" h	\$17.26
G2586613	white	3	360	1¾" w x 1½" d x 4" h	\$17.26
G2994092	ivory	6	720	2¾" w x 3" d x 4½" h	\$33.46
G3472551	white	6	720	2¾" w x 3" d x 4½" h	\$33.46

**BROAN Ceiling or Wall Mount Bathroom Fans**

- 25 ga galvanized steel
- Polymeric grilles
- 9" x 9-1/4" grille
- 7½" w x 7¼" l x 3¾" h housing
- White, 120 V

• **UL LISTED, HVI CERTIFIED**

*includes brackets for mounting to ceiling joist or wall stud, round damper and duct connector*



#	cfm	sones	amp	price
G2221441	50	3.5	0.8	\$23.99
G2221606	60	5.5	1.15	\$26.99
G3013017	70	6.0	1.15	\$29.88





# FANS & HVAC

MORE THAN 800,000 ITEMS ONLINE

## DAYTON

### Unit Heater Thermostat

- 20 ga steel with neutral gray powder coat
- Vertical or horizontal mount
- 208/240 V
- **UL/CUL STANDARDS**

features totally enclosed fan motor, (4) top and (4) back threaded reinforced holes for field mounting with 3/16" threaded rod (not included) and automatic reset linear thermal protector

Q#	BtuH	mounting height	horiz air throw	vert floor coverage	price
G0638251	12,600/17,000	8' max	12'	18'	<b>\$517.09</b>
G1588377	19,100/25,600	9' max	18'	26'	<b>\$762.77</b>
G3499605	25,600/34,100	9' max	18'	26'	<b>\$826.68</b>



## DAYTON

### Line Voltage Thermostat

- SPST switch
- 40° to 120° F
- 24V to 277V
- Unit mounted
- Required for Dayton unit heaters G0638251, G1588377, G3499605

Q#	price
G1794667	<b>\$107.40</b>



## BROAN

### Commercial Electric Wall Heater

- 18 ga steel grille
- Recessed or surface mount
- 1500/3000, 2000/4000 W
- 5120/10,240, 6827/13,653 BtuH
- 4 1/4" d x 14 1/4" w x 18" h housing
- 208/240 V
- **UL STANDARDS**

Q#	price
G1406036	<b>\$199.14</b>



## BROAN

### Residential Electric Wall Heater

- 20 ga steel
- Surface mounting
- 750/1500, 1000/2000 W
- 208/240 V
- 2560/5120, 3413/6827 BtuH
- 10 1/4" w x 3 3/4" d x 7 3/4" h wall opening
- **UL STANDARDS**

Q#	price
G2338752	<b>\$94.38</b>

## FOSTORIA Electric Infrared Heaters

- Steel housing with brown powder coat finish
- Indoor/outdoor use
- 60° beam pattern
- 6' cord
- **ETL STANDARDS**

### 1500 W

- 5120 BtuH output
- 120 V
- 5 3/4" w x 41" l x 6 1/2" h
- includes (2) 4' long chains and (4) S hooks

Q#	price
G0541983	<b>\$187.00</b>

### 3000 W

- 10,235 BtuH
- 240 V
- 5 3/4" w x 52" l x 6 1/2" h
- includes (2) 2' long chains and (4) S hooks

Q#	price
G3090421	<b>\$226.60</b>



## DAYTON

### Electric Space Heater

- Fan-forced
- Non-oscillating
- 72" power cord
- 1500/1000/650 W
- 120 V
- 7 3/4" w x 7 1/4" d x 10 7/8" h
- **UL/CUL STANDARDS**

features auto overheat shut off protection, safety tip-over switch and power indicator light

Q#	price
G1327182	<b>\$54.24</b>

## DAYTON

### Electric Space Heater

- Fan-forced
- 1500/1300 W
- 72" power cord
- 120 V
- 8" w x 10" d x 16" h
- **UL/CUL STANDARDS**

features auto overheat shut off protection, safety tip-over switch, power indicator light, buzzer alarm and thermostat

Q#	price
G0600451	<b>\$74.45</b>



## AIR KING

### Electric Pedestal Heater

- Fan-forced
- Oscillating
- 72" power cord
- 1500/900 W
- 120 V
- 7 1/4" w x 8 1/2" d x 23" h
- **ETL STANDARDS**

includes remote and features auto overheat shut off protection, power indicator light, thermostat, auto fan setting, LCD display, 7 hr timer, digital with oscillating feature

Q#	price
G2347791	<b>\$68.38</b>



## AIR KING

### Electric Space Heater

- Fan-forced
- Non-oscillating
- 1500/900 W
- 120 V
- 11 3/4" w x 11 1/8" d x 11 3/8" h
- **ETL STANDARDS**

features pivoting, auto overheat and shut off protection with thermostat

Q#	price
G0998051	<b>\$61.33</b>

## DAYTON

### Electric Space Heater

- Fan forced/radiant
- 5120/3071/2047 BtuH
- 1500/900/600 W
- 120 V
- 11" d x 11-1/2" w x 15" h
- **UL/CUL STANDARDS**

features auto overheat shut off protection, safety tip-over switch, power indicator light, thermostat, buzzer alarm, unit is radiant on low setting only, fan operation on med and high settings only

Q#	price
G0650727	<b>\$92.88</b>



## QMARK Electric Flat Panel Heater

- Radiant heat
- 170 W, 120 V
- 580 BtuH
- 22" w x 1" d x 15" h
- 72" power cord
- **cETUS STANDARDS**
- features safety tip over switch, power indicator light and on/off switch built into cord

Q#	price
G2500111	<b>\$69.85</b>





**DAYTON Oil Fired Torpedo Heaters**

- Use K1 kerosene, #1 fuel oil
- Safety features thermal protection, fuel safety shutoff

includes led failure indicator light and air pressure gauge and features on/off switch, fuel gage and power failure indicator

**Floor Standing**

- 12" w x 30" l x 15" h

#	BtuH	heating area	operating hrs/fill	price
G2569603	45,000	1000 sq-ft	14	<b>\$229.08</b>
G2389414	75,000	1700 sq-ft	8.75	<b>\$272.66</b>

**Wheeled**

- G2701447: 22" w x 38" l x 25" h
- G1359452: 24" w x 43" l x 26" h

#	BtuH	heating area	operating hrs/fill	price
G2701447	125,000	2900 sq-ft	10	<b>\$386.57</b>
G1359452	170,000	4000 sq-ft	10	<b>\$476.84</b>

**DAYTON Infrared Gas Tube Heaters**

- Infrared gas tube heaters
- Indoor/outdoor use
- Natural gas
- 4" vent
- 120 V

includes mounting chains, stainless steel flexible gas connector and gas shut off

#	BtuH	mounting height	dimensions	price
G1793233	75,000	13' min	18 3/4" w x 260" l x 8 3/4" h	<b>\$1,008.45</b>
G2002594	100,000	15' min	18 3/4" w x 492" l x 8 3/4" h	<b>\$1,321.36</b>
G1945045	150,000	16' min	18 3/4" w x 492" l x 8 3/4" h	<b>\$1,340.45</b>
G1738816	200,000	18' min	18 3/4" w x 607" l x 8 3/4" h	<b>\$1,528.03</b>

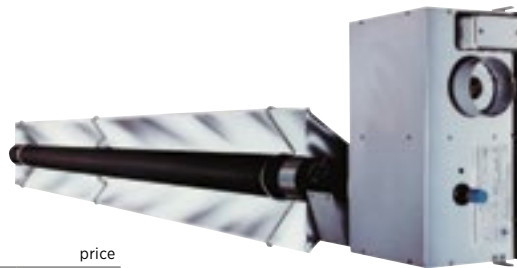

**DAYTON Gas Unit Heaters**

- 20 ga aluminized steel primary heat exchanger
- Hot surface pilot
- 8' to 20' installation height
- Power vent, 1/2" gas connection, 5" flue
- ■ ETL STANDARDS

**NG**

#	BtuH input	BtuH output	dimensions	price
G2306981	150,000	121,500	25 1/4" w x 43 3/4" d x 33 3/4" h	<b>\$1,146.23</b>
G0659111	200,000	162,000	37 3/4" w x 43 3/4" d x 33 3/4" h	<b>\$1,468.27</b>
G1210011	250,000	202,500	37 3/4" w x 43 3/4" d x 24 1/2" h	<b>\$1,602.73</b>

**LP**

#	BtuH input	BtuH output	dimensions	price
G0530713	150,000	121,500	25 1/4" w x 43 3/4" d x 33 3/4" h	<b>\$1,146.23</b>
G2274605	200,000	162,000	37 3/4" w x 43 3/4" d x 33 3/4" h	<b>\$1,468.27</b>
G2896354	250,000	202,500	37 3/4" w x 43 3/4" d x 24 1/2" h	<b>\$1,602.73</b>



**DAYTON Torpedo Portable Gas Heater**

- LP
- 20 lb min cylinder size
- 8 3/4" w x 19 1/4" l x 15 1/8" h

includes 15' hose and regulator and features 3/8" flare connection, fuel shut off device and automatic overheat shut-off protection

#	BtuH	heating area	price
G2693302	40,000	940 sq-ft	<b>\$190.49</b>
G1405354	30,000/60,000	1350 sq-ft	<b>\$271.20</b>

**EMPIRE Gas Wall Furnaces**

- Beige powder coat removable panels for easy cleaning
- Standing pilot ignition
- Direct vent, 3/8" npt
- ■ CSA STANDARDS

includes basic vent kit and wall thermostat

**NG**

#	BtuH input	BtuH output	dimensions	price
G4541162	15,000	10,500	20 3/4" w x 9 3/4" d x 25" h	<b>\$545.96</b>
G4529436	25,000	17,500	37" w x 11 1/2" d x 27 3/4" h	<b>\$714.15</b>
G4573177	35,000	24,500	37" w x 11 1/2" d x 27 3/4" h	<b>\$745.90</b>

**LP**

#	BtuH input	BtuH output	dimensions	price
G4633973	15,000	10,500	20 3/4" w x 9 3/4" d x 25" h	<b>\$668.49</b>
G4578427	25,000	17,500	37" w x 11 1/2" d x 27 3/4" h	<b>\$824.84</b>
G4585892	35,000	24,500	37" w x 11 1/2" d x 27 3/4" h	<b>\$822.35</b>

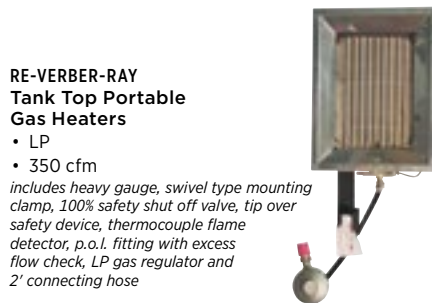

**RE-VERBER-RAY Tank Top Portable Gas Heaters**

- LP
- 350 cfm

includes heavy gauge, swivel type mounting clamp, 100% safety shut off valve, tip over safety device, thermocouple flame detector, p.o.l. fitting with excess flow check, LP gas regulator and 2' connecting hose

**16,000 BtuH**

- 10 1/2" w x 4 1/2" l x 13 1/4" h

#	heating area	price
G2250735	40 to 400 sq-ft	<b>\$160.95</b>

**32,000 BtuH**

- 10 1/2" w x 4 1/2" l x 18" h

#	heating area	price
G2892391	50 to 500 sq-ft	<b>\$173.63</b>

**DAYTON Multi Position NG Furnaces**

- Electronic hot surface ignition
- 100% shut off main gas valve
- PSC 4-speed direct drive motor
- High level self diagnostics with fault code displays
- Convertible to LP gas

**80%+ AFUE**

#	BtuH input	BtuH output	available cooling tons	cfm @ .5 ESP	dimensions	price
G2536326	60,000	48,000	1 1/2 to 3	1338	14 1/2" w x 29 1/2" d x 33" h	<b>\$923.79</b>
G2706024	80,000	64,000	1 1/2 to 4	1442	21" w x 29 1/2" d x 33" h	<b>\$937.90</b>
G2289131	100,000	80,000	2 to 5	1984	14 1/2" w x 29 1/2" d x 33" h	<b>\$951.18</b>
G2106605	120,000	96,000	2 to 5	2056	21" w x 29 1/2" d x 33" h	<b>\$1,134.61</b>

**95%+ AFUE**

#	BtuH input	BtuH output	available cooling tons	cfm @ .5 ESP	dimensions	price
G0315673	60,000	57,000	1 1/2 to 3	1200	17 1/2" w x 29 1/2" d x 33" h	<b>\$1,077.34</b>
G3319102	80,000	76,000	1 1/2 to 3	1200	17 1/2" w x 29 1/2" d x 33" h	<b>\$1,301.44</b>
G2142244	100,000	95,000	1 1/2 to 5	2000	21" w x 29 1/2" d x 33" h	<b>\$1,276.54</b>





## FANS & HVAC



### VALUE BRAND Baseboard Diffusers

- Steel construction
- includes damper

Z#	color	dimensions	price
G2509175	White	15" wx 2.75" dx 4.5" h	<b>\$8.59</b>
G0400057	White	18" wx 2.75" dx 4.5" h	<b>\$10.15</b>
G1948152	Brown	15" wx 2.75" dx 4.5" h	<b>\$8.59</b>
G0696297	Brown	18" wx 2.75" dx 4.5" h	<b>\$10.15</b>



### VALUE BRAND Louvered Floor Diffusers

- Welded steel construction
- Electro coated and powder coated surface

Z#	max duct width	dimensions	price
G1064551	8"	9.5" wx 1.55" dx 5.5" h	<b>\$3.65</b>
G3442643	10"	11.5" wx 1.55" dx 5.5" h	<b>\$3.74</b>
G0542823	12"	13.5" wx 1.55" dx 5.5" h	<b>\$4.68</b>
G2425586	10"	11.5" wx 1.55" dx 7.5" h	<b>\$6.13</b>
G2029797	12"	13.5" wx 1.55" dx 7.5" h	<b>\$7.14</b>
G1012593	14"	15.5" wx 1.55" dx 7.5" h	<b>\$9.92</b>

### WESTAFLEX Noninsulated Flexible Duct

- For heating and cooling systems
- Aluminum alloy
- 1/8" wall thickness
- 500° F max temperature
- 5000 fpm max air flow

#### 15' Length

includes (2) stainless steel screw clamps for #G0748483, G2978403 and G1145602

Z#	ID	price
G0748483	3"	<b>\$19.68</b>
G2978403	4"	<b>\$22.50</b>
G1145602	6"	<b>\$33.57</b>
G3451847	8"	<b>\$41.88</b>

#### 30' Length

Z#	ID	price
G1284297	3"	<b>\$46.96</b>
G3508531	4"	<b>\$47.29</b>
G1301386	6"	<b>\$70.57</b>
G3085031	8"	<b>\$99.75</b>
G3124091	10"	<b>\$111.12</b>
G2984633	12"	<b>\$117.70</b>



### JOHNS MANVILLE Duct Insulation Wrap

- Fiberglass with foil scrim kraft jacket
- 1/2" thick, 48" x 25'
- -32° to 250° F temperature range
- ■ ASTM C-411, ASTM C-1104, ASTM C665, ASTM C-1338, ASTM E-84, UL723, NFPA 90A, CAN/ULC S102-1188, ASTM C1290, ASTM C553, ASTM C11365 STANDARDS

Z#	"R" factor	density	price
G3618982	4.2	3/4 lb	<b>\$46.75</b>
G3643062	6.5	1 lb	<b>\$73.46</b>



### VALUE BRAND 3-Way Sidewall/Ceiling Registers

- Welded steel construction
- 1/2" bar spacing

Z#	max duct height	max duct width	dimensions	price
G3018355	4"	10"	11.75" wx 1.18" dx 5.75" h	<b>\$4.23</b>
G0497673	8"	10"	11.75" wx 1.18" dx 9.75" h	<b>\$7.11</b>
G0794674	8"	14"	15.75" wx 1.18" dx 9.75" h	<b>\$9.32</b>
G1213256	6"	14"	15.75" wx 1.18" dx 7.75" h	<b>\$7.25</b>



### VALUE BRAND Return Air Grilles

- Electro coated and powder coated surface
- 1/2" bar spacing
- Steel construction

Z#	max duct height	max duct width	dimensions	price
G0279081	8"	12"	13.75" wx .31" dx 9.75" h	<b>\$3.90</b>
G3337397	8"	14"	15.75" wx .31" dx 9.75" h	<b>\$4.39</b>
G3429632	8"	16"	17.75" wx .31" dx 9.75" h	<b>\$4.57</b>
G1092917	8"	24"	25.75" wx .31" dx 9.75" h	<b>\$8.03</b>



### VALUE BRAND Return Air Filter Grilles

- Removable face
- Electro coated and powder coated surface
- 1/2" bar spacing
- Steel construction

Z#	max duct height	max duct width	dimensions	price
G1403333	12"	12"	14.57" wx 1.13" dx 14.57" h	<b>\$13.38</b>
G3445942	14"	14"	16.57" wx 1.13" dx 16.57" h	<b>\$17.85</b>
G2912384	20"	20"	22.57" wx 1.13" dx 22.57" h	<b>\$28.78</b>
G1493834	24"	24"	26.57" wx 1.18" dx 26.57" h	<b>\$39.04</b>



### GREENSEAM Press-On Collars With Dampers

- For use with Greenseam duct system
- 26 ga galvanized steel
- Pre-sealed/low leakage hardware
- ■ SMACNA/ASTM STANDARDS

Z#	duct size	price
G2673483	4"	<b>\$14.73</b>
G1193604	6"	<b>\$17.35</b>
G0677537	8"	<b>\$17.06</b>
G3101271	10"	<b>\$21.88</b>
G0278677	12"	<b>\$24.67</b>



### BROAN Transition Ducts

- For connecting a rectangular duct to a round duct
- 30 ga galvanized steel

Z#	duct size	price
G0959174	3 1/2" x 10" to 6" round	<b>\$12.01</b>
G1341103	3 1/2" x 10" to 7" round	<b>\$14.46</b>
G2577644	4 1/2" x 18 1/2" to 10" round	<b>\$27.64</b>
G2812494	8" x 12" to 12" round	<b>\$35.20</b>



### GREENSEAM 90° Elbows

- For use with Greenseam duct system
- 26 ga galvanized steel
- ■ SMACNA/ASTM STANDARDS

Z#	duct size	price
G3248156	4"	<b>\$4.45</b>
G0571575	6"	<b>\$4.65</b>
G0441174	8"	<b>\$6.77</b>
G0274041	10"	<b>\$10.53</b>
G1953007	12"	<b>\$13.83</b>



### TJERNLUND Axial Duct Boosters

- Galvanized steel
- External junction box for easy wiring
- 150° F inlet temperature
- Horizontal or vertical mount
- 120V

Z#	fits duct	cfm at duct	price
G1296495	6"	150/100/90	<b>\$41.30</b>
G2730926	8"	300/250/200	<b>\$53.19</b>
G3127223	10"	400/325/275	<b>\$116.86</b>
G1892414	12"	800/700/600	<b>\$134.98</b>



### FANTECH Inline Centrifugal Duct Fans

- Thermoplastic housing
- 140° F max inlet temperature
- Horizontal or vertical mount
- 115/120V
- ■ C-UL-US STANDARDS

Z#	fits duct	cfm	price
G0874937	4"	122	<b>\$109.98</b>
G2701973	6"	263	<b>\$134.19</b>



### DAYTON Fan Speed Controls

- Use with dayton and other compatible speed controllable ventilators and fans
- Fits single gang box
- 115V
- ■ UL COMPONENT RECOGNIZED

includes mounting screws and wire nuts, use with G1296495, G2730926, G3127223, G1892414, G0874937 and G2701973

Z#	max wattage	dimensions	price
G5287764	6A/720W	2 3/4" wx 1 3/4" dx 4 3/4" h	<b>\$26.44</b>
G5287773	10A/1200W	4 3/8" wx 2 3/4" dx 4 3/4" h	<b>\$61.67</b>



**AMERI-VENT Gas Vent Pipe**

- Type B
- Snap lock coupling
- Rugged double wall construction
- 400° to 550°F
- 5' long



Q #	dia	price
G3022932	4"	<b>\$30.56</b>
G1710353	5"	<b>\$31.46</b>
G2482261	6"	<b>\$41.84</b>



**AMERI-VENT Adjustable Gas Vent Elbow**

- Type B gas vent system
- 90° bend angle
- Adjustable to 90°
- Snap lock coupling
- 400° to 550°F

Q #	dia	dimension b	dimension c	price
G0698993	4"	5½"	1½"	<b>\$16.55</b>
G1646522	5"	6"	2¼"	<b>\$19.74</b>
G2940472	6"	7"	2½"	<b>\$21.95</b>

**K-FLEX USA Insulation Sheets**

- Elastomeric material with skin on (2) sides
- -297° to 220°F
- 36" x 48"
- ■ ASTM C 534 TYPE 2 SHEETING; ASTM D 1056-00-2C1; NEW YORK CITY MEA 186-86-M VOL. IV; USDA REQUIREMENTS, UL 94-5V FLAMMABILITY CLASSIFICATION (RECOGNITION # E300774); ASTM E84 1½" 25/50 TESTED ACCORDING TO UL 723 AND NFPA 255; COMPLIES WITH REQUIREMENTS OF CAN/ULC S102-M88; NFPA NO 101 CLASS A RATING; MEETS REQUIREMENTS OF NFPA 90A SECT 2.3.3 FOR SUPPLEMENTARY MATERIALS FOR AIR DISTRIBUTION SYSTEMS, MEETS REQUIREMENTS OF ASTM C 411 (TEST METHOD FOR HOT SURFACE PERFORMANCE OF HIGH TEMPERATURE THERMAL INSULATION); MEETS REQUIREMENTS OF UL 181 SECTIONS 11.0 AND 16.0 (MOLD GROWTH/AIR EROSION), MIL-P-15280 FOR S (SHEETING)

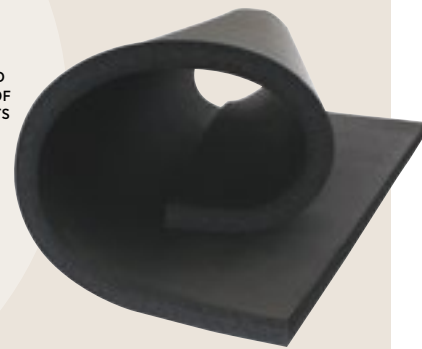

Q #	approx "R" factor	thickness	price
G2127273	2	½"	<b>\$22.52</b>
G1542721	3	¾"	<b>\$34.60</b>
G0679472	4	1"	<b>\$41.96</b>



**THERMACEL Pipe Insulation**

- Pre-slit polyethylene
- -160° to 200°F
- 2" ID
- 6' long
- ■ ASTM C 1427 STANDARDS

Q #	approx "R" factor	wall thickness	price
G1242552	2.4	½"	<b>\$4.07</b>
G1212486	1.8	¾"	<b>\$6.34</b>

**OWENS CORNING Pipe Insulation Tape**

- For fiberglass ASJ pipe insulation
- Fiberglass tape
- 0° to 150°F
- 3" x 150'
- Pressure sensitive adhesive and release liner



Q #	price
G1478181	<b>\$31.96</b>



**WESTAFLEX Chimney Liner Kits**

- For use with NG
- 500°F
- Dimension B 10', dimension C 35'
- includes flashing, rain cap, B-vent connector and mortar sleeve

Q #	length/dia	bend angle	price
G4662463	25' x 4"	24°	<b>\$101.12</b>
G4677032	25' x 6"	36°	<b>\$136.60</b>

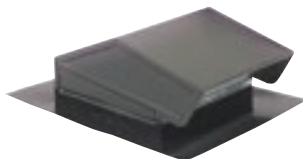

**BROAN Roof Caps**

- Use for vent terminations
- Steel with black epoxy finish
- Built-in bird screen with cushioned backdraft damper
- 6½" x 10¼" cap
- 14¼" x 18¾" flange

Q #	fits duct	price
G2078474	3¾" x 10 to 8" rd	<b>\$19.93</b>
G1100041	6"	<b>\$30.75</b>



**TJERNLUND High Temperature Vent Hoods**

- Horizontal vent terminations for gas fired equipment
- Heat shield which provides a clearance from combustible material contained in walls

Q #	fits duct	price
G1120813	4"	<b>\$106.64</b>
G2573076	6"	<b>\$110.59</b>



**AMERI-VENT Firestop Support Plate**

- Use with type B gas venting

Q #	ID	OD	skirt	price
G1031231	4"	4¾"	6½"	<b>\$14.78</b>
G0681904	5"	5¾"	7½"	<b>\$15.62</b>

**BROAN Wall Caps**

- Use for vent terminations
- Aluminum construction
- Built-in backdraft damper and bird screen
- 9" x 9" flange
- Aluminum alloy



Q #	fits duct	price
G2009822	6"	<b>\$27.32</b>
G2218264	7"	<b>\$38.40</b>

**AMERI-VENT Gas Vent Pipe Kit**

- Use with type B gas venting
- For gas heaters
- 90° bend angle
- includes cap, storm collar, flashing, draft hood connector and 12" adjustable length

Q #	dia	price
G1800242	4"	<b>\$50.12</b>
G1574824	5"	<b>\$59.82</b>
G1109744	6"	<b>\$84.97</b>



# FANS & HVAC

MORE THAN 800,000 ITEMS ONLINE

### DAYTON

#### Low Voltage Thermostat

- 1 stage heat and cool
- 5-2 programs per week
- 4 temp settings/day
- Heat/cool or single stage heat pump
- Hardwired

features freeze protection and adjustable energy usage counters



Z# price  
G0298557 **\$65.86**

### HONEYWELL

#### Low Voltage Thermostat

- 1 stage heat and cool
- 5-2 programs per week
- 4 temp settings/day
- 40° to 99° F
- Hardwired/battery
- 5 3/8" w x 1 1/4" d x 3 1/8" h



Z# price  
G1653495 **\$32.87**

### HONEYWELL

#### Touchscreen Low Voltage Thermostat

- For gas, oil, electric heat, or heat pump, outdoor or indoor remote sensors
- 4 temp settings/day
- 3 stages heat, 2 stages cool, 7 programs/week
- 40° to 99° F
- 20 to 30 VAC
- 10 sq-in display
- 4 1/8" w x 1 1/4" d x 4 5/8" h



Z# price  
G1827253 **\$142.51**

### ROBERTSHAW

#### Digital Thermostats

- 45° to 90° F
- Hardwired 18 to 30 VAC
- Auto-heat-cool system switching
- Auto-on-intermittent-program fan switching
- 5 1/4" w x 1 1/8" d x 3 3/4" h

#### Gas, Oil or Electric Heating/Cooling Systems

- English, spanish or french display option
- 4 digit PIN# access code

Z# price  
G2143373 **\$84.89**

#### Multi-Stage Gas, Oil, or Electric Heating/Cooling Systems

- English, Spanish or French display option
- 3 levels of security
- Humidification control



Z# price  
G1667075 **\$109.83**

### EMERSON CLIMATE

#### Touchscreen Low Voltage Thermostat

- For heat, cool, and heat pump systems
- 3 stages heat, 2 stages cool
- 5-1-1, 7 programs per week or Nonprogrammable
- 24 VAC hardwired/battery
- 12 sq-in display
- 5 1/8" w x 1 1/4" d x 4 5/8" h

features audible feedback, selectable high/low temp limits and key pad programming



Z# price  
G2220845 **\$133.53**

### JOHNSON CONTROLS

#### Low Voltage Thermostats

- Auto-heat-cool-off
- 40° to 100° F
- Programmable fan
- 24 VAC
- ■ cTUVus, CE AGENCY COMPLIANCE

#### 2 Stages Heat/Cool

- Y2,Y1,G,RC,C,RH,W1,W2,AUX,DI1,DI2,RS,Scom,OS,MS terminal designations

Z#	remote sensing capability	humidification control	dehumidification control	price
G6506211*	yes	no	no	<b>\$363.59</b>
G6574687*	no	yes	yes	<b>\$446.47</b>

#### 1 Stage Heat/Cool

- Fan-H,Fan-M,Fan-L,24 V Hot,24 V Com, BO5 Aux,BO5 Aux,BO3,BO4,BO1,BO2,BI1,RS,Scom,BI2,UI3

Z#	remote sensing capability	humidification control	dehumidification control	price
G7153894*	no	no	no	<b>\$207.38</b>
G6778755*	no	no	yes	<b>\$378.88</b>



### COLUMBUS ELECTRIC

#### Attic Fan Thermostat

- Use with attic ventilators, fans and dampers
- 80° to 130° F
- Close on rise
- Cooling only
- 120 to 240 VAC



Z# price  
G1081245 **\$20.94**



### DAYTON

#### Attic Fan Thermostat

- Use with attic ventilators
- 60° to 120° F
- Close on rise
- Cooling only
- 120V input

Z# price  
G3896103 **\$33.91**

### FANTECH

#### Dehumidistat

- SPST switch
- 20% to 80% RH range
- 120 V
- ■ UL COMPLIANCE



Z# price  
G4693351 **\$41.43**



### HONEYWELL

#### Thermostat With WiFi

- For gas, oil, electric heat, or heat pump, outdoor or indoor remote sensors
- 3-heat, 2-cool stages
- 4-daily temp settings 7 times per week
- 12 sq-in display
- 24 VAC

features wifi internet connected Visionpro thermostat, comfort and control from anywhere through web, tablet or smartphone access, precise comfort control +/-1° F, change/check reminders — let you know when to service or replace filters and batteries

Z# price  
G4998253 **\$149.63**

### DAYTON

#### Humidifier/Dehumidifier Controller

- 30% to 90% RH range
  - Opens on humidity rise, close on fall
  - 120 V
  - ■ ETL COMPLIANCE
- includes screws and mounting plate



Z# price  
G2387917 **\$44.94**

eZTIPS  
technical resources

eZTips about thermostats are available online at [zoro.com/eztips](http://zoro.com/eztips)



**COLUMBUS ELECTRIC**  
**Line Volt Mechanical Thermostats**

- HSJ cord with piggyback plug, mount with suspension chain or wire
- -10° to 100°F
- SPST switch
- 6' power cord
- 120 V input



**For Portable Heaters**

- Open on rise

#	price
G1134156	<b>\$35.49</b>

**For Fans and Portable, Fixed Cooling Systems**

- Close on rise

#	price
G4288837	<b>\$55.92</b>

**DAYTON**  
**Line Volt Mechanical Thermostat**

- -10° to 100°F
  - Agricultural, commercial and industrial applications
  - SPST switch open on rise
  - Heating only
  - 120 to 277 VAC range
  - CSA STANDARDS
- includes contacts that open on temperature rise for heating applications*



#	price
G1493755	<b>\$43.78</b>

**DAYTON**  
**Line Volt Mechanical Thermostat**

- 50° to 90°F
- For cooling systems
- SPST switch
- Close on rise
- 120 to 277 VAC input voltage
- CSA STANDARDS



#	price
G1112973	<b>\$29.92</b>

**ROBERTSHAW**  
**Line Volt Mechanical Thermostat**

- 50° to 90°F
- Mounts to standard 2" x 4" electrical box
- 125 to 277 VAC input
- UL STANDARDS



#	switch action	type	price
G3069272	open on rise	heat only	<b>\$12.77</b>
G2158764	close on rise	cool only	<b>\$18.28</b>

**AIR HANDLER Pleated Air Filters**

- Standard capacity pleated filter
- Moisture resistant die cut chipboard frame
- 180° max temperature
- UL 900 CLASSIFIED

**MERV 7 Standard Capacity**

#	size	price
G4638146	16" x 20" x 2"	<b>\$5.19</b>
G3774267	16" x 25" x 1"	<b>\$5.33</b>
G4638155	16" x 25" x 2"	<b>\$5.70</b>
G3756042	16" x 20" x 4"	<b>\$9.77</b>
G3774407	20" x 20" x 1"	<b>\$4.80</b>
G4638164	20" x 20" x 2"	<b>\$5.19</b>
G4638173	20" x 25" x 2"	<b>\$6.68</b>
G4638182	24" x 24" x 2"	<b>\$7.48</b>

**MERV 8 High Capacity**

#	size	price
G4638191	16" x 20" x 2"	<b>\$7.71</b>
G4638207	16" x 25" x 2"	<b>\$8.78</b>
G4638216	20" x 20" x 2"	<b>\$8.85</b>
G4638225	20" x 25" x 2"	<b>\$10.08</b>
G4638234	24" x 24" x 2"	<b>\$11.00</b>



**AIR HANDLER Filter Media Rolls**

- For use where fiberglass filters are not acceptable or fiber break-off is a concern
- Designed for commercial and industrial use
- MERV 7
- 90' length
- UL CLASSIFIED

#	size	price
G0393504	1" x 16"	<b>\$33.09</b>
G1782986	1" x 20"	<b>\$36.11</b>
G1962012	1" x 24"	<b>\$49.37</b>
G3064643	1" x 25"	<b>\$49.79</b>
G3247693	1" x 30"	<b>\$63.34</b>
G1093705	1" x 36"	<b>\$78.59</b>



**AIR HANDLER Fiberglass Air Filters**

- MERV 5
- Heavy duty chipboard frame
- 150° F max
- UL 900 CLASSIFIED

#	size	price
G3773901	16" x 20" x 1"	<b>\$3.37</b>
G3776561	16" x 25" x 1"	<b>\$4.11</b>
G3774714	16" x 20" x 2"	<b>\$3.95</b>
G3775712	16" x 25" x 2"	<b>\$4.33</b>
G3775037	20" x 20" x 1"	<b>\$3.67</b>
G3774836	20" x 20" x 2"	<b>\$4.39</b>
G3777891	20" x 25" x 1"	<b>\$4.23</b>
G3776981	20" x 25" x 2"	<b>\$5.11</b>

**HONEYWELL Pop-Up Filters**

- MERV 11
- REFRIGERATING AND AIR-CONDITIONING ENGINEERS STANDARD 522-1999

#	dimensions	price
G3668987	24 3/4" w x 5 1/2" d x 20 3/4" h	<b>\$27.49</b>
G3738156	25" w x 5" d x 16" h	<b>\$27.93</b>
G3625973	25" w x 5" d x 20" h	<b>\$30.79</b>



**HONEYWELL**  
**Drain Bypass Furnace Humidifiers**

- Mounts directly on plenum
- Requires floor drain or drain pump for water overflow
- 120 V

*includes self piercing saddle valve, 24 V transformer, H8908 humidistat, summer shutoff damper, antimicrobial humidifier pad and mounting template*

- 3000 Max Sq-Ft Capacity**
- 9 1/8" h x 9 1/8" w plenum opening required
  - 12" w x 9 1/2" d x 13 1/8" h

#	price
G2300584	<b>\$139.61</b>

- 4000 Max Sq-Ft Capacity**
- 12 5/8" h x 9 3/4" w plenum opening required
  - 12" w x 9 1/4" d x 16 1/4" h

#	price
G0506247	<b>\$163.07</b>

**Replacement Humidifier Pads**

#	use with	price
G2681314	G0506247	<b>\$12.42</b>
G2901683	G2300584	<b>\$12.92</b>



**WHITE-RODGERS**  
**Furnace Humidifier — Steam**

- Mounts directly on plenum
- 1850 max sq-ft capacity
- 10 1/2" h x 8" w required plenum opening
- Auto flush drain
- 17 gal/24 hr max water usage
- 240 VAC
- 12 5/8" w x 12 1/2" d x 7 3/8" h

*includes flushing timer and chlorine removal filter*

#	price
G4726163	<b>\$705.30</b>





# FANS & HVAC

MORE THAN 800,000 ITEMS ONLINE



### HONEYWELL Ducted Whole House Dehumidifiers

- Ducted or stand alone
- 0 to 99 RH range
- 34° to 135° F ambient temperature range
- R-410 A refrigerant

• ■ ETL TESTED PER STANDARD UL 474

Z#	capacity	cfm	refrigerant charge	price
G4475721	65 pt	120	15 oz	<b>\$996.39</b>
G4475737	90 pt	180	1 lb	<b>\$1,260.13</b>
G4475746	120 pt	210	1 lb	<b>\$1,620.93</b>



### DAYTON Residential Dehumidifiers

- 41° to 95° F ambient temperature range
- 35 to 80 RH range
- Auto defrost
- 115 V

• ■ UL AGENCY COMPLIANCE

Z#	capacity/24 hrs @ 60% RH	price
G5215551	30 pt	<b>\$247.76</b>
G5215576	50 pt	<b>\$292.16</b>
G5215567	70 pt	<b>\$334.28</b>



### FRIEDRICH Residential and Light Commercial Dehumidifiers

- 30 to 90 RH range
- 41° to 95° F ambient temperature range
- 2 speed fan
- 16.2 pt bucket capacity
- R-410 A refrigerant
- Built in condensate pump
- 15' drain hose

• ■ UL, CUL, AHAM, ENERGY STAR

Z#	capacity	refrigerant charge	voltage	price
G5136582	50 pt	8.5 oz	115	<b>\$259.00</b>
G3545665	70 pt	11 oz	115	<b>\$299.00</b>

### FANTECH Restoration Portable Dehumidifier

- 125 pt capacity/ 24 hrs @ 60% RH
- 0 to 100 RH range
- 40° to 95° F ambient temperature range
- 300 cfm fan
- R-410 refrigerant
- ■ cSAus STANDARDS includes electronic controls, digital hr meter, integrated upper and lower handles, on demand condensate pump purge, defrost indicator light, 11" wheels, 30' drain hose with quick connect and external hose storage



Z#	price
G1338303	<b>\$1,516.60</b>

### DAYTON Plug-In-Outlet Controllers

- 30 to 90% RH adjustable range
- +/- 1% RH differential
- 15.0 A resistive, 3.0 A inductive contact rating
- 120 V
- ■ ETL COMPLIANCE



#### Humidifier

- Opens on humidity rise, close on fall

Z#	price
G0627006	<b>\$63.04</b>

#### Dehumidifier

- Closes on humidity rise, opens on fall

Z#	price
G3370446	<b>\$63.04</b>

### ESSICK AIR PRODUCTS

#### Table Top Portable Humidifier

- 700 max sq-ft capacity
- 3 gal/24 hr
- 2 gal water reservoir
- 125 cfm fan
- Auto humidistat
- 120 V



Z#	price
G1824785	<b>\$52.29</b>

#### ESSICK AIR PRODUCTS Mini Console Portable Humidifier

- 1200 max sq-ft capacity
- 5.5 gal/24 hr
- 3 gal water reservoir
- 4 speeds
- 120 V



Z#	price
G1972196	<b>\$76.77</b>

#### ESSICK AIR PRODUCTS Tower Style Portable Humidifier

- 1300 max sq-ft capacity
- 6.0 gal/24 hr
- 2 gal water reservoir
- 4 speeds
- 120 V

includes water tanks with handles and locking clips and (2) evaporative wicks



Z#	price
G1047015	<b>\$85.43</b>

### FANTECH Industrial Portable Dehumidifier

- 60 pt capacity/24 hrs @ 60% RH
- 20 to 80 RH range
- 21 pt bucket capacity
- 40° to 95° F ambient temperature range
- For industrial/ commercial use in areas with excess moisture.
- Removes excess moisture from the air to prevent mildewing, musty odors, sweating on walls and windows, and damage to exposed surfaces



• 115 V

• ■ UL/cUL/CSA CE STANDARDS

Z#	price
G1398135	<b>\$499.45</b>

### DRI-EAZ Restoration Portable Dehumidifier

- 85 pt capacity/24 hrs @ 60% RH
- 45 to 99 RH range
- 33° to 100° F ambient temperature range
- 227 cfm fan
- R-410 A refrigerant
- 115 V
- ■ ETL CERTIFIED TO UL/CSA STANDARDS, AHAM includes electronic touch controls, hour use meter, high airflow filter, 40' drain hose, fixed metal handle, automatic purge pump, stackable design, semi pneumatic wheels and built-in duct ring



Z#	price
G2350914	<b>\$1,485.00</b>

### VENTA Portable Humidifier and Air Purifier

- 400 max sq-ft capacity
- 2 gal water reservoir
- 123.6 cfm fan
- 11½" w x 11½" d x 13" h
- 120 V



Z#	color	price
G7594386	white	<b>\$252.65</b>

### VENTA Humidifier Cleansing Agent

- For Venta humidifiers/purifiers
- 8 oz

Z#	price
G7477391	<b>\$8.84</b>



### BEST AIR Humidifier Algae and Bacteria Inhibitor

- For portable type humidifiers
- Adds life to filters, belts, and operating parts
- Inhibits the growth of odor-causing bacteria and algae in manual-filled humidifiers
- 32 oz



Z#	price
G1611653	<b>\$4.59</b>

**FRIGIDAIRE Window Air Conditioners**

- Electronic controls
- 3 fan and cooling speeds
- 6' power cord
- R410 A refrigerant
- AHAM, UL, CUL STANDARDS



**Fixed Chassis**

- 10,000 BtuH cooling
- 115V, 8.8A
- 11.3 EER
- 19" w x 21½" d x 14½" h

includes pleated quick mount window kit

#	price
G5352541	\$355.19



**Slide Out Chassis**

- 10,000 BtuH cooling
- 115V, 8.5A
- 11.3 EER
- 23½" w x 21½" d x 15" h

includes LCD remote control, washable filter, expandable side curtains, standard installation hardware and manuals

#	price
G5405872	\$552.52



**FRIEDRICH PTAC Wall Thermostat**

- For use with Friedrich PTAC, Vert-I-Pak
- 5½" x 3¾"
- 24VDC

includes thermostat on base, thermostat cover, wiring labels, screws and wall anchors, installation, operation and application guide

#	price
G3607843	\$108.00



**A/C SAFE Window Air Conditioner Support**

- Window Air Conditioners Up to 80 lb
- 4 to 11" wall opening

includes built-in level and mounting hardware

#	price
G0489377	\$25.41

**Window Air Conditioners Up to 160 lb**

includes built-in level and mounting hardware

#	price
G0947877	\$29.92



**DAYTON Portable Evaporative Cooler**

- 3800/2376 cfm
- 1000 to 1400 sq-ft cooling capacity
- 2 speed ½ HP motor
- 28¾" w x 28¾" d x 36¾" h
- 10.4 gal capacity
- 10' power cord
- 115V
- ETL STANDARDS

includes float bulb, overflow water tube and media pads

#	price
G3607082	\$618.77



**DAYTON Portable Air Conditioner**

- For residential/light commercial use
- 28,000 BtuH cooling
- 22" w x 29½" d x 57½" h
- 208/230V

includes soft touch buttons, digital display w/trouble shooting codes, self checking function, alarm lamp (warns when condensate container is max), spot cool setting and room cool setting

#	price
G0248622	\$6,151.13

**DAYTON Rigid Self Supported Triple Cool Air Duct**

- 4½" diameter
- 19½" length
- Use with G0248622

#	price
G2151572	\$301.91



**FRIEDRICH Insulated Wall Sleeve**

- 42" w x 13¾" w x 16" h

#	price
G0413366	\$150.00



**FRIEDRICH Standard Grille**

- Anodized silver

#	price
G0923842	\$57.00



**FRIEDRICH Packaged Terminal Air Conditioners**

- R-410 A refrigerant
- 230/208V
- 5' power cord
- Requires wall sleeve

includes chassis, front panel and installation instructions



#	BtuH cooling	BtuH heating	EER	power supply	price
G8634087	7200/7000	11,700/9600	13.0/13.0	20A	\$705.00
G8634096	11,800/11,600	11,700/9600	11.6/11.6	20A	\$753.00
G8634105	14,500/14,200	11,700/13,900	10.4/10.4	30A	\$830.00

**FRIEDRICH Portable Air Conditioners**

- Residential/light commercial applications
- Ambient operating range 63° to 95°F
- 120V
- 3 fan & cooling speeds
- Electronic control with remote
- UL/CUL STANDARDS

includes (2) exhaust hoses and sliding window curtain for each side of the hose to seal window opening

#	BtuH	ampere	dimensions	price
G1284017	9300	10.8	19¼" w x 15½" d x 33¾" h	\$499.00
G2139347	11,600	11.5	19¼" w x 15½" d x 33¾" h	\$599.00



**PORT-A-COOL Portable Evaporative Coolers**

- 2 speed ½ HP motor
- Front discharge
- 115V

#	cfm	cooling capacity	water capacity	dimensions	price
G3543005	1600/2000	500 sq-ft	10 gal	24" w x 25" d x 31" h	\$539.00
G0977435	2400/3000	700 sq-ft	16 gal	25" w x 25" d x 38" h	\$739.00



eZTips about evaporative coolers are available online at [zoro.com/eztips](http://zoro.com/eztips)



## FANS & HVAC



### PORT-A-COOL Evaporative Cooling Pads

- Kraft paper, polymer material
- For residential/commercial/industrial
- 6" thickness

Q#	size	coolers require	price
G0498994	12" x 24"	3 pads per unit	<b>\$53.56</b>
G2196704	12" x 36"	4 pads per unit	<b>\$58.92</b>
G0881361	12" x 48"	5 pads per unit	<b>\$64.27</b>

### CENTURY PSC Condenser Fan Motors

- Totally enclosed air-over enclosure
  - 1075 rpm
  - 48Y frame
  - CW/CCW rotation
- features energy efficient, auto protector, extended through bolts, G2351474 capacitor required, see pg 131*

- ¾ HP, ¼ HP
- 208/230 V
- **UL RECOGNIZED (E46412/E44549), CSA CERTIFIED (LR43341/LR4642)**

Q#	HP	full load amps	price
G1433722	¾	0.8-0.9	<b>\$44.09</b>
G2473685	¼	1.2-1.3	<b>\$63.70</b>

- ¾ HP
- 460 V
- **UL RECOGNIZED (E46412), CSA CERTIFIED (LR43341)**

Q#	full load amps	price
G0990595	2.2	<b>\$179.60</b>



### CENTURY Open Air-Over Condenser Fan Motors

- 1140 rpm
  - 56Y frame
  - CW/CCW rotation
  - 3-phase/200-230/460 V
- features auto protector, quick connect design, reversible*

Q#	HP	full load amps	type	price
G0773473	1	5.3-5.2/2.6	flat shaft	<b>\$202.28</b>
G2150066	1½	5.8-6.0/3.0	keyed shaft	<b>\$293.62</b>
G2208062	2	6.8-6.2/3.1	flat shaft	<b>\$318.32</b>

### DIVERSITECH Condenser Mounting Pads

- For any type of equipment that requires weight distribution support
- 125 lbs per sq-in
- 2" thick

Q#	size	price
G2329661	16" x 36"	<b>\$14.24</b>
G2931196	30" x 30"	<b>\$34.33</b>
G3454631	36" x 36"	<b>\$38.30</b>
G0703805	36" x 48"	<b>\$38.36</b>



### LITTLE GIANT Vertical Condensate Pumps

- Polypropylene float and stainless steel shaft
  - 140°F max
  - ¾" barbed discharge
  - 115 V
- includes check valve, safety switch, 6' power cord, thermal overload protector, nylon sump pan, control float and filter screen*

Q#	HP	water @ 1 ft of head	shut off	price
G3466881	¾	65 gph	15'	<b>\$47.90</b>
G3199585	¾	80 gph	20'	<b>\$36.20</b>

### DIVERSITECH Plastic Condensate Drain Pans

- Rolled edges, ribbed bottoms, and reinforced corners
  - 2" deep
- includes ¾" PVC fitting*

Q#	size	price
G2925282	29" x 41"	<b>\$33.62</b>
G1763824	29" x 50"	<b>\$41.46</b>
G2970466	29" x 65"	<b>\$46.49</b>
G2263484	32" x 32"	<b>\$24.56</b>
G2998615	32" x 52"	<b>\$31.24</b>
G1173575	32" x 62"	<b>\$39.25</b>
G0613051	34" x 65"	<b>\$52.25</b>
G0689412	38" x 38"	<b>\$36.02</b>
G2995054	38" x 62"	<b>\$59.10</b>



### SUPCO Hard Start Kit

- Residential and commercial refrigerators and freezers
- Relay, overload and start capacitor
- For use with RSIR, CSIR, PSC, and CSR compressors
- ¼ to ½ HP
- 115 V

Q#	price
G1212041	<b>\$8.36</b>



### SUPCO Hard Start Kit

- For use on residential and commercial air conditioning units, heat pumps and room air conditioners
- Provides additional starting torque to all single phase 115 to 288 V units
- Relay and start capacitor
- For use with PSC and CSIR compressors
- ½ to 10 HP
- 115 V

Q#	price
G1772574	<b>\$8.85</b>



### PANASONIC Air Conditioner Compressors

- For window A/C and PT A/C units
  - R-22 refrigerant
  - 1 phase
- includes motor protector and mounting parts*

115 V						
Q#	BtuH	line connect suction ID/ discharge ID	nominal HP	run capacitor	price	
G4276867	5595	¾"/¼"	½	35 mf/230 V	<b>\$240.21</b>	
G4276876	7955	¾"/¼"	¾	35 mf/250 V	<b>\$260.25</b>	
G4196333	11,350	½"/¼"	1	45 mf/250 V	<b>\$269.35</b>	
G4194766	12,700	½"/¼"	1½	45 mf/260 V	<b>\$346.53</b>	

208/230 V						
Q#	BtuH	line connect suction ID/ discharge ID	nominal HP	run capacitor	price	
G4213483	6625	¾"/¼"	¾	15 mf/370 V	<b>\$301.14</b>	
G3913323	8550	¾"/¼"	¾	15 mf/370 V	<b>\$305.18</b>	
G4040617	11,350	½"/¼"	1	30 mf/330 V	<b>\$321.96</b>	
G4205415	12,660	½"/¼"	1½	30 mf/370 V	<b>\$335.52</b>	



**SPECTROLINE**

**Refrigerant Leak Detection Kit**

- For small and medium refrigeration systems, commercial
- Very high intensity blue LED
- Rechargeable NiMH battery pack
- Universal dye

includes no. 2DPH8 Optimax rechargeable inspection led flashlight, EZ-ject dye injector, (2) EZ-ject cartridges, fluorescence-enhancing glasses, Glo-away cleaner, perge fitting, AC and 12V DC charger, plastic carrying case and instructions

#	price
G1012024	<b>\$293.99</b>

**SPECTROLINE**

**EZ-Ject Dye Cartridge**

- For small and medium size AC&R systems
- Amount of oil in system up to 2 gal
- Amount of refrigerant up to 25 lbs
- POE, Alkylbenzene, or mineral compressor oil
- 6 pack

#	price
G0879234	<b>\$104.95</b>



**IMPERIAL Charger**

- For use with HCFC and HFC refrigerants
- Built in check, opens for drawing unrestricted vacuum
- Fast safe charge, liquid low side, eight times faster than vapor charging

#	price
G0954493	<b>\$49.93</b>



**SUPCO**

**Line Piercing Charging Valve**

- For use with all CFC, HCFC and HFC refrigerants

• (2) piece aluminum  
includes (3) hex head screws

#	connection	price
G3776927	¼", ⅜", ½"	<b>\$2.72</b>
G3756356	½", ¾"	<b>\$3.24</b>



**SOURCE 1**

**Refrigerant Cap Lock Screwdrivers**

#	type	color	price
G4466411	for R-410 A	rose	<b>\$12.83</b>
G4466384	for R-22	green	<b>\$12.68</b>

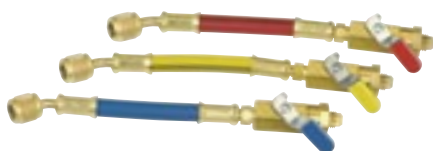

**IMPERIAL**

**Hose Shut Off Set**

- Fits between valve and fitting for use in tight places
- 800 psi working/4000 psi burst pressure
- ¼" female connection
- 6" length
- For use with R-410 A

#	price
G2008291	<b>\$64.97</b>



**IMPERIAL**

**Charging Hose Set**

- Replacement hoses for any manifold gauge set
- Flexible, with durable eight sided crimp ensures long life
- Kevlar-lined barrier hose
- For HCFC and HFC refrigerants
- 60" length
- ¼" female connection
- 800 psi working pressure
- UL RECOGNIZED, MEETS UL 1963 AND SAE 2196

#	price
G1899387	<b>\$44.97</b>

**VALUE BRAND**

**Butyl Tape**

- Thermal insulation tape against heat, water, and air
- For metal pipes, tubing and fittings
- 2" x 30'
- ⅛" thick

#	price
G0701757	<b>\$9.81</b>



**VIRGINIA KMP**

**Thermal Mastic**

- Heat sink compound paste
- -50° to 220° F
- 7.5 oz

#	price
G2052924	<b>\$8.99</b>



**SPEEDYFOAM**

**Condenser Coil Cleaner**

- Biodegradable expanding foam cleaner
- For use with air cooled condensers and coils
- Alkaline
- 1 gal
- ORMD STANDARDS

#	price
G3217663	<b>\$26.93</b>



**NU-CALGON**

**Aerosol Evaporator Cleaner**

- Use on evaporator coils
- Improves heat transfer
- Increases system capacity
- Reduces head pressure
- Lemon scented
- 18 oz aerosol can
- Non-flammable
- NSF REGISTERED, MEETS OSHA

#	price
G0530914	<b>\$12.38</b>





# FANS & HVAC

MORE THAN 800,000 ITEMS ONLINE

### ROBERTSHAW Thermopile Pilot Assemblies

- LP or NG
  - 32" l
  - 750 mV
  - 2 wire spade
- includes NG and LP orifice



Z#	tip style
G1455912	90° right
G3383886	90° left

each **\$34.27**



### ROBERTSHAW Replacement Thermocouple

- Universal coaxial ODS
- 18 to 30 mV
- LP/NG
- Low mass, for quick drop out, non vented equipment
- 27" length

Z#	price
G0892893	<b>\$10.00</b>



### STEVECO Magnetic Enclosed Heavy Duty Fan Relays

- For switching single or (2)-speed fan motors, solenoids, relays, resistive loads and other general-purpose switching
- Quick connect push on terminals
- 120/240 V
- **UL STANDARDS**

Z#	switch type
G0747083	SPNO/SPNC
G3072842	SPDT

each **\$7.66**



### STEVECO AC Switching Magnetic Relays

- For air conditioning, heating/ventilating control system, motor starting, heating element operation and power supply control
- Universal mounting
- DPDT Switch
- ½ HP
- **UL STANDARDS**

Z#	coil volts	price
G1481566	24	<b>\$9.10</b>
G3319181	115/120	<b>\$9.83</b>



### VALUE BRAND Snap Disc Fan Control

- Close on rise
- 120 to 240 V
- 25 resistive amps
- SPST switch

Z#	switch closes	switch opens
G4142013	110° F	90° F
G3975282	90° F	80° F

each **\$3.34**



### VALUE BRAND Auto Reset Adjustable Limit Controls

- SPST open on rise switches
- 25 resistive amps
- 120/240 V
- 125VA pilot duty contacts

Z#	switch closes	switch opens
G3630015	115° to 155° F	135° to 175° F
G3612813	135° to 175° F	175° to 215° F
G3722826	170° to 210° F	210° to 250° F
G3617022	210° to 250° F	250° to 290° F

each **\$8.98**

### ICM Time Delay Relays

- Adjustable time ranges
- ¼" quick-connect terminals
- Single hole mounting
- -40° to 167° F
- Anti short cycle protection for anticipator type thermostats in HVAC and refrigeration
- **IEEE587 AGENCY COMPLIANCE**



#### Delay On Make

- (2) wire hook up
- Compressor staging and protection
- 1.8 to 600 sec time delay
- 18 to 240 V
- 1.5A contact rating

Z#	price
G2825864	<b>\$5.80</b>

#### Delay On Break

- (2) wire hook up
- Compressor staging and protection
- 1.8 to 600 sec time delay
- 18 to 240 V
- 1.5A contact rating

Z#	price
G1959745	<b>\$5.60</b>

#### Delay On Break Lockout

- Provides brown-out and lock-out protection
- 180 to 600 sec time delay
- 18 to 30 V
- 1.5A contact rating

Z#	price
G2439412	<b>\$6.93</b>

#### Post-Purge

- Provides off delay for fan
- 12 to 390 sec time delay
- 18 to 30 V
- 1A contact rating

Z#	price
G2754753	<b>\$13.29</b>



**DAYTON Shutter Motor Pack**

- For use with ceiling shutters
- 120/240 V

includes installation hardware

#	price
G4581272	<b>\$117.45</b>



**DAYTON Power Attic Ventilators**

- Weatherwood steel
- Thermostatically controlled roof mount
- 1/2 HP
- 24" dome diameter
- 2100 max attic area (sq-ft)
- 1500 cfm @ 0.030-in SP
- 120 V

includes thermostat, and thermally protected motor for G4275607 and includes thermostat, humidistat, and thermally protected motor for G4262675

#	price
G4275607	<b>\$162.89</b>
G4262675	<b>\$177.21</b>



**DAYTON Backdraft Dampers**

- G-90 galvanized steel frame, aluminum blades, stainless steel pivot pins, nylon bushings and galvanized steel tie rods construction
- Roof mount, exhaust

includes pre-punched conduit hole knock-out and felted edges for quiet operation

#	damper	outside max flange	fpm	use with	price
G2807287	12" x 12"	14" x 14"	2000	G0838756 & G2284676	<b>\$28.30</b>
G2083094	15" x 15"	17" x 17"	2000	-	<b>\$34.82</b>
G1847526	23" x 23"	25" x 25"	2250	-	<b>\$56.11</b>



**EMPIRE Wind-Driven Turbine Ventilators**

- Galvanized steel with aluminum bracing
  - Requires base for new installations
- features oilless bronze upper bearing and lower thrust type ball bearing

#	throat dia	cfm	size	price
G0837837	4"	126	10 1/4" x 12"	<b>\$34.85</b>
G1176917	6"	147	12 3/4" x 14 1/2"	<b>\$40.78</b>
G3459407	8"	255	14 3/4" x 15"	<b>\$44.09</b>
G2962032	12"	631	19" x 17"	<b>\$47.88</b>

**DAYTON Whole House Fan Premium Ceiling Shutters**

- Extruded aluminum frame and G-90 galvanized tie rod
- White painted aluminum blades
- 2250 fpm max
- Prepunched mounting holes
- Horizontal mount



#	fits	required opening	frame	price
G1930686	24" whole house fans	24" x 24"	26" x 26"	<b>\$83.33</b>
G1804616	30" whole house fans	30" x 30"	32" x 32"	<b>\$91.84</b>
G3017287	36" whole house fans	36" x 36"	38" x 38"	<b>\$116.99</b>
G3113022	42" whole house fans	42" x 42"	44" x 44"	<b>\$174.72</b>

**DAYTON Assembled Whole House Fans**

- Effectively cool and ventilate an entire home by removing hot, humid air through the attic and drawing in cooler air from outside
- Gasket between the venturi and plenum box reduces noise
- Requires shutter for new installations
- Belt drive
- 115 V hard wired

includes 2-speed wall switch with 12 hr timer

#	propeller	cfm (high/low)	coverage	HP	dimensions	price
G1681671	24"	1610/3700	850 sq-ft	1/2	28" w x 28" d x 23" h	<b>\$450.69</b>
G0456102	30"	4280/6510	1500 sq-ft	1/2	34" w x 34" d x 24" h	<b>\$474.76</b>
G2204255	36"	7290/10,820	2500 sq-ft	1/2	40" w x 40" d x 26" h	<b>\$549.88</b>
G1553982	42"	7600/11,370	3000 sq-ft	1/2	46" w x 46" d x 26" h	<b>\$621.67</b>



**DAYTON Upblast Ventilators**

- Spun aluminum housing
- Roof mount
- Requires roof curb for new installation
- ■ UL/CUL 705, AMCA SOUND & AIR STANDARDS

#	speed	wheel size	HP	cfm	drive	speed controllable	price
G0838756	3	8 3/4"	1/2	266/223/180	direct	yes	<b>\$324.95</b>
G0720867	1	14 3/4"	3/4	2889	belt	no	<b>\$1,241.68</b>



**DAYTON Attic Ventilators**

- Thermostatically controlled gable mount with shutter and guard
  - 90° to 130°F
  - 120 V
- includes thermostat

#	cfm	sq-ft	opening required	price
G2667743	800	1600 max	13" x 13"	<b>\$202.11</b>
G1309287	1095	1500 max	16 3/4" x 16 3/4"	<b>\$293.61</b>
G1625583	1860	2300 max	19" x 19"	<b>\$320.38</b>

**DAYTON Actuator**

- Use with G1930686, G1804616, G3017287 & G3113022 fan shutters

#	price
G5188635	<b>\$131.97</b>



**DAYTON Yoke Kit**

- Use with G5188635 actuator

#	price
G7355704*	<b>\$38.18</b>



**EMPIRE Attic Ventilator Base**

- Galvanized steel
- Allows vertical mounting of ventilator on 0/12 to 7/12 pitch roofs
- Has 20" x 20" flashing for weatherproof installation
- Use with G2962032 12" turbine ventilator

#	price
G0895465	<b>\$19.99</b>

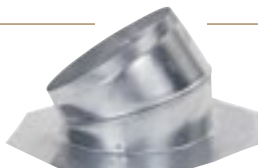

**VALUE BRAND Motor Bracket**

- Use with G5188635 actuator

#	price
G7329305*	<b>\$42.50</b>

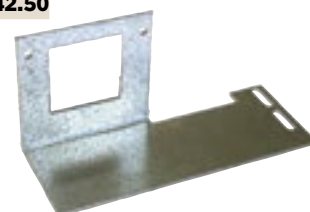



# FANS & HVAC

MORE THAN 800,000 ITEMS ONLINE

## DAYTON Industrial Assembled Air Circulator Heads

- Wall, pedestal or I-beam mount
- 2 speeds
- 10' cord
- 115 V
- ■ UL, CUL, OSHA STANDARDS

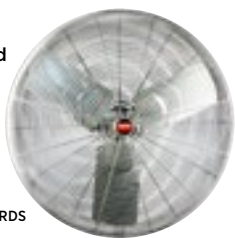

### Non-Oscillating Fans

Z#	propeller dia	cfm	HP	price
G1854404	20"	3055/4700	¼	<b>\$291.54</b>
G1828802	24"	3800/6100	½	<b>\$387.61</b>
G2998721	30"	8712/9704	¾	<b>\$409.19</b>

### Oscillating Fans

Z#	propeller dia	cfm	HP	price
G0867063	20"	3055/4700	¼	<b>\$362.09</b>
G0738726	24"	4460/6400	½	<b>\$429.11</b>
G3057153	30"	8674/9612	¾	<b>\$475.18</b>

## DAYTON Commercial Unassembled Air Circulators

- Non-oscillating
- 2 speeds
- 10' cord
- 115 V
- ■ UL/CUL STANDARDS

### Wall/Ceiling Mounted Fans

includes wall and ceiling bracket

Z#	propeller dia	cfm	price
G0376722	20"	2600/3700	<b>\$213.10</b>
G3466102	24"	3800/5450	<b>\$235.72</b>
G2532171	30"	4650/7250	<b>\$263.11</b>

### Pedestal Mounted Fans

includes pedestal, column and hex key

Z#	propeller dia	cfm	adj height	price
G2601821	20"	2600/3700	51" to 61"	<b>\$261.24</b>
G2042101	24"	3800/5450	53" to 61"	<b>\$279.50</b>
G0318936	30"	4650/7250	64" to 86"	<b>\$310.42</b>

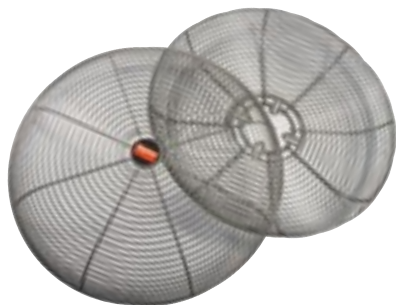

## DAYTON Steel Air Circulator Guards

- Gray polyester powder coat finish
- For use with 3.3" diameter, 48 and 56 frame motors
- ■ OSHA STANDARDS

includes (1) front and (1) rear section

Z#	propeller dia	guard dia	price
G1645761	20"	23"	<b>\$49.14</b>
G0752972	24"	27"	<b>\$55.61</b>
G0358556	30"	33"	<b>\$93.91</b>

## DAYTON Replacement Propellers

- Industrial/commercial
- Aluminum blades
- Direct drive
- ½" bore



Z#	propeller dia	rpm	use with air circulator	price
G0562712	20"	1700	G1854404, G0867063	<b>\$73.29</b>
G1490142	24"	1075	G0738726, G1828802	<b>\$87.31</b>
G1613157	30"	1075	G2998721, G3057153	<b>\$95.16</b>

## DAYTON Steel Mounting Bracket

- Gray polyester powder coat
- For Dayton yoke mounted air circulator heads, up through 30"

includes secondary safety support cable and assembly hardware

Z#	price
G1823726	<b>\$37.60</b>

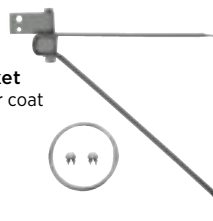

## DAYTON Pedestal Mounted Air Circulators

- 3-speed stationary, non-oscillating
- Light commercial applications
- ½ HP, 115 V
- ■ UL/OSHA STANDARDS

### Adjustable Height 48" to 58"

Z#	propeller dia	cfm	price
G2183212	16"	1800/2450	<b>\$166.21</b>

### Adjustable Height 52" to 62"

Z#	propeller dia	cfm	price
G0890881	20"	2700/3650	<b>\$173.47</b>



## DAYTON Industrial Mobile Air Circulators

- 2-speed, non-oscillating
  - 9' cord
  - 115 V
  - ■ UL/CSA/OSHA
- includes cord wrap and tilt wheel and 7" plastic and rubber casters

Z#	propeller dia	cfm	price
G3279017	24"	3600/5800	<b>\$397.36</b>
G1189361	30"	4700/6900	<b>\$505.06</b>
G0381062	36"	8350/12,250	<b>\$633.71</b>
G0475824	42"	9000/15,000	<b>\$798.05</b>

## DAYTON Light Commercial Air Circulators

- 3-speed stationary, non-oscillating
  - Wall, ceiling or floor mount
  - 1/6 HP, 115 V
  - ■ UL/OSHA STANDARDS
- includes wall and ceiling bracket

Z#	propeller dia	cfm	price
G2296192	16"	1800/2450	<b>\$37.60</b>
G3062787	20"	2700/3650	<b>\$130.10</b>



## DAYTON Replacement Motors

- Yoke mount

Z#	use with air circulator	price
G2667147	G0867063	<b>\$447.79</b>
G1945492	G1854404	<b>\$255.43</b>
G2134185	G1828802	<b>\$237.59</b>
G3442652	G2998721	<b>\$272.86</b>



## DAYTON Steel Floor Pedestal

- Gray polyester powder coat
  - For Dayton yoke mounted air circulator heads, up through 30"
  - Adjustable height 39½" to 60"
  - 33" base
- includes assembly hardware

Z#	price
G0269202	<b>\$135.71</b>







**DAYTON Air Curtain Cabinet**  
• Painted steel

60" w x 12 1/2" d x 15 3/4" h  
• Required for G3373151

#	price
G1602526	<b>\$610.05</b>

48" w x 12 1/2" d x 15 3/4" h  
• Required for G0708994

#	price
G3417495	<b>\$446.54</b>

**DAYTON Fan Speed Control**

- Rotary with forward/reverse switch
- 120 V
- 540 W max
- Use with G2671191, G1016741, G0802907, G0308953

• **UL RECOGNIZED COMPONENT**  
includes mounting screws

#	price
G2513497	<b>\$123.26</b>



**DAYTON Commercial Ceiling Fans**

- 10' to 45' mounting height
- Speed controllable/reversible
- 120 V

• **CSA/CUS STANDARDS**  
includes J hook, safety hook and fastening hardware and 24" steel downrod

#	propeller dia	high cfm	price
G0802907	56"	28,000	<b>\$223.06</b>
G0308953	60"	46,000	<b>\$305.23</b>

**DAYTON Air Curtain Blowers**

- Galvanized steel housing
- PSC motors, 115 V

includes quick disconnect

#	HP	fpm	mounting height	door width	dimensions	price
G0708994	1/4	2500	10' max	4' max	35" w x 11" d x 9 3/4" h	<b>\$467.71</b>
G3373151	3/4	4585	12' max	8' max	35" w x 11" d x 10 3/4" h	<b>\$586.40</b>



**BERNER Low Profile Air Curtains**

- Powder coated steel housing
- 1 speed, 1/2 HP motor
- 7' max mounting height
- 115/208-240 V

• **UL NSF 37, EPH ANSI, NSF 37, UL INDOOR, UL OUTDOOR AND CUL INDOOR STANDARDS**  
includes door limit switch, plunger style, for automatic operation

#	door width	cfm	dimensions	price
G1509155	3' max	1020	36 3/4" w x 8" d x 8 1/2" h	<b>\$862.73</b>
G1586094	3.5' max	1188	42 3/4" w x 8" d x 8 1/2" h	<b>\$890.35</b>
G1245106	4' max	1360	48 3/4" w x 8" d x 8 1/2" h	<b>\$1,064.15</b>



**DAYTON Low Profile Air Curtains**

- Painted steel light tan housings
- PSC motor
- 2 speeds
- 8' max mounting height
- 120 V

includes 2-speed switch

#	door width	cfm	HP	dimensions	price
G0851085	3' max	1050/790	3/10	36" w x 6 3/4" d x 7 3/8" h	<b>\$762.36</b>
G2849411	4' max	1200/900	3/8	42" w x 6 3/4" d x 7 3/8" h	<b>\$837.47</b>
G1131523	6' max	1700/1280	3/8	60" w x 6 3/4" d x 7 3/8" h	<b>\$1,115.52</b>



**MARS AIR DOORS Heated Air Curtain**

- Galvanized steel housing
- 6' wide door & 10' height mount max
- 72" w x 17 1/4" d x 10 5/8" h
- 24 kW heating
- 5100 cfm
- 1/2 HP

• **ETL STANDARDS**  
includes thermostat and motor control panel

#	price
G4676533	<b>\$3,270.50</b>



**MARS AIR DOORS Roller Plunger Door Switch**

- For all low profile and multipurpose air curtains
- 20 A
- 120/208-230 V

#	price
G3398613	<b>\$66.97</b>



**CANARM Commercial Ceiling Fans**

- 16' to 21' mounting height
- Variable speeds/reversible
- 120 V
- 56" blade diameter
- 20,500 high cfm

• **CSA/CUS STANDARDS**  
includes mounting hardware

#	color
G6446167	black steel
G6786105	white steel
G6401245	brown steel

each **\$123.19**



**DAYTON Commercial Ceiling Fans**

- 8' to 20' mounting height
- Speed controllable/reversible
- 120 V

• **CSA/CUS STANDARDS**  
includes J hook, safety hook and fastening hardware and 24" steel downrod

#	propeller dia	high cfm	price
G2671191	48"	21,000	<b>\$183.43</b>
G1016741	56"	25,500	<b>\$219.33</b>



# FANS & HVAC



### TJERNLUND In-Line Draft Inducers

- Aluminized steel housing and blower wheel
- Provides positive draft for smokepipe and aids proper exhaust of combustion gas
- 115 V
- ■ REQUIRES G0473155 FOR CSA CERTIFICATION

Q#	HP	vent pipe dia	cut out required	watts	price
G3198054	3/80	3" to 6"	2 3/8" x 7 1/8"	35	<b>\$98.85</b>
G2587042	3/20	5" to 8"	3 3/8" x 8 3/8"	74	<b>\$126.84</b>



### TJERNLUND Air Sensing Switch

- For oil, gas or coal fired systems in commercial and industrial applications
- Designed to monitor the fan housing pressure
- 125 VA at 24 VAC, 300 VA up to 277 VAC, 15 A non-inductive to 277 VAC
- For use with G3198054 & G2587042

Q#	price
G0473155	<b>\$72.70</b>



### TJERNLUND In-Line Draft Inducers

- Aluminized steel housing and blower wheel
- Provides positive draft for smokepipe and aids proper exhaust of combustion gas
- 115 V

Q#	HP	vent pipe dia	cut out required	price
G0357052	3/4	8" to 12"	4" x 12 3/4"	<b>\$360.93</b>
G3403723	3/4	9" to 18"	4 1/4" x 14 3/4"	<b>\$395.42</b>



### TJERNLUND Universal Interlock Control

- Prepurge time 0-120 sec
- Postpurge time 0-960 sec
- Time delay 0-960 sec
- 24" conduit length
- includes quick connect motor and prover switch leads

Q#	price
G2808172	<b>\$125.90</b>

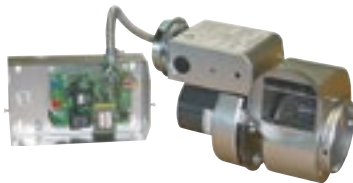

### TJERNLUND High Temperature Induced Draft Blowers

- Provides side wall venting commercial natural gas or LP fired equipment including boilers, water heaters and unit heaters
- Aluminized steel housing and blower wheel
- 115 V
- ■ ETL LISTED TO UL378 AND CAN3-B255-M81 includes UCI interlock control, fan proving switch, adjustable damper and vibration isolators

Q#	inlet and outlet dia	vent pipe dia	ampere	watts	price
G3172163	4"	4"	1.26	95	<b>\$207.59</b>
G0255245	4"	4" or 6"	1.26	95	<b>\$243.74</b>
G0975317	6"	6" or 8"	1.51	224	<b>\$345.09</b>
G1004613	8"	8" or 10"	2.60	286	<b>\$635.78</b>

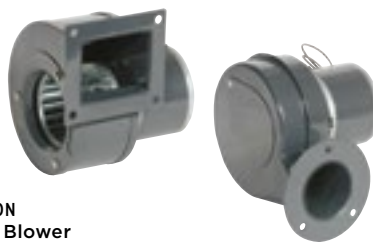

### DAYTON OEM Blower

- 104° F max ambient temperature
- 115 V

### 3 1/16" and 3" Wheel Diameter

- ■ UL RECOGNIZED US AND CANADA (E47479), CE

Q#	rpm	outlet	size	price
G2445581	3100	rectangular	3 1/16"	<b>\$76.40</b>
G0861226	3036	round	3"	<b>\$64.12</b>

### 5 1/4" Wheel Diameter

- Rectangular outlet shape
- ■ UL COMPONENT RECOGNIZED, CSA CERTIFIED

Q#	rpm	price
G0995732	3100	<b>\$66.98</b>



### JABSCO 12 VDC OEM Blowers

- Glass filled polypropylene housing
- Multi positional mounting
- Totally enclosed motor
- 130° F max ambient temperature
- ■ NMMA/USCG REGULATION 183.410, ISO 9097 MARINE AND ISO 8846 STANDARDS includes mounting bracket

Q#	wheel	cfm	rpm	price
G1992697	1 3/4" w x 3 3/4" dia	105	3500	<b>\$59.90</b>
G3138414	1 3/4" w x 3 3/4" dia	150	2500	<b>\$97.10</b>
G1517941	2 1/2" w x 4" dia	250	2500	<b>\$127.84</b>



### DAYTON High Pressure Blowers Without Motors

- Steel housing with polyester epoxy finish
- 180° F max inlet temperature
- 104° F max ambient temperature
- Aluminum wheel
- ■ AMCA AIR AGENCY COMPLIANCE

Q#	wheel dia	wheel bore	price
G1101947	8 1/16"	3/2"	<b>\$205.01</b>
G0687416	10 3/16"	3/4"	<b>\$231.99</b>
G2422953	12 1/2"	7/8"	<b>\$333.66</b>
G2907177	13 1/2"	1 1/8"	<b>\$468.12</b>



### DAYTON High Pressure Blowers With Motors

- Gray polyester epoxy finish
- Aluminum wheels
- 3450 rpm
- Unassembled
- ■ AMCA AIR AGENCY COMPLIANCE

### 115/230 V

Q#	wheel	HP	cfm	motor frame	price
G1217124	2 3/16" w x 9" dia	1/2	270	48	<b>\$384.29</b>
G3258893	3" w x 10 1/2" dia	1	559	56	<b>\$476.01</b>

### 208-230/460 V

Q#	wheel	HP	cfm	motor frame	price
G1005907	3" w x 10 1/2" dia	1	559	56	<b>\$613.37</b>
G1956595	3" w x 12 1/2" dia	3	953	145T	<b>\$922.13</b>



### DAYTON Axial Fans

- 4 1/16" w x 4 1/16" d x 1 1/2" h
  - ■ UL AND CUL COMPONENT RECOGNIZED
- | Q#       | housing       | cfm | rpm  | voltage | price          |
|----------|---------------|-----|------|---------|----------------|
| G3318971 | cast aluminum | 105 | 2900 | 115 VAC | <b>\$30.59</b> |
| G0935821 | cast aluminum | 105 | 2900 | 230 VAC | <b>\$30.59</b> |
| G2684875 | PBT plastic   | 138 | 3100 | 24 VDC  | <b>\$44.70</b> |

### DAYTON Axial Fan Cord Sets

- 115/230 V
  - 24" long
- | Q#       | head configuration | price         |
|----------|--------------------|---------------|
| G1301176 | 45°                | <b>\$2.34</b> |
| G0408712 | 90°                | <b>\$1.78</b> |



**CENTURY Direct Drive PSC Blower Motors**

- For direct drive furnace blowers, unit heaters, air conditioners, many other shaft mounted fan and blower uses
- Open air-over enclosure
- 1075 rpm
- CW/CCW rotation
- **UL RECOGNIZED, CSA CERTIFIED**

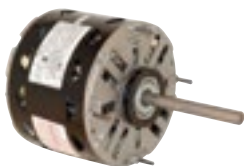

**115/230 V**

Q #	HP	price
G2547815	1/4	<b>\$65.60</b>
G2613134	1/2	<b>\$84.73</b>
G0995443	3/4	<b>\$87.89</b>
G1613446	1	<b>\$105.70</b>



**CENTURY Direct Drive PSC Blower Motors**

- Exceptionally quiet operation on shaft mounted blowers with 9" or 10" diameter wheels
- Open air-over enclosure
- 1075 rpm
- CW/CCW Rotation
- **UL RECOGNIZED, CSA CERTIFIED**

**208-230 V**

Q #	HP	price
G1499863	1/4	<b>\$110.23</b>
G0934543	1/2	<b>\$114.21</b>
G0380143	3/4	<b>\$136.21</b>



**DAYTON Belt Drive Motors For HVAC/R**

- For belt drive fans and blowers
- Split-phase
- 1725 rpm
- 115 V
- 48Y frame
- Open dripproof

Q #	HP	price
G1715935	1/4	<b>\$79.27</b>
G3354863	1/2	<b>\$87.77</b>
G1464915	3/4	<b>\$118.69</b>



**CENTURY Evaporative Cooler Motors**

- Split-phase open dripproof
- 2 speeds
- 1725/1140 rpm
- CCWLE rotation
- 115 V
- **UL, CSA STANDARDS**

Q #	HP	price
G2144021	3/4, 1	<b>\$94.85</b>
G3415623	1 1/2, 2	<b>\$74.84</b>

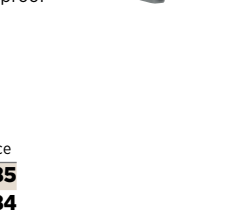

**DAYTON Motor Run Capacitors**

- Aluminum case with steel cover
- 4 blade quick-connect insulated terminal
- -40° to 70° C
- 370 V, 60/50 Hz

Q #	mfd	dimensions	use with blower motor	price
G3303352	5	2" wx 1 1/4" dx 2 3/4" h	G2547815, G1499863	<b>\$5.79</b>
G3132534	7.5	2" wx 1 1/4" dx 3 3/8" h	G2613134, G0934543	<b>\$6.32</b>
G2351474	10	2" wx 1 1/4" dx 3 3/8" h	G0995443, G0380143	<b>\$7.45</b>
G1021693	15	2" wx 1 1/4" dx 3 3/8" h	G1613446	<b>\$10.62</b>



**CENTURY Belt Drive Motors For HVAC/R**

- Split-phase
- 1725 rpm
- 115 V
- 48 frame
- Continuous duty

Q #	HP	standards	price
G1049027	1/4	CSA certified	<b>\$68.04</b>
G1384704	1/2	UL recognized	<b>\$108.24</b>
G0702274	3/4	CSA certified	<b>\$89.00</b>



**DAYTON 4.4" HVAC/R Motors**

- For direct drive fans and blowers
- Shaded pole OAO
- CWSE rotation
- Continuous duty
- 115 V
- **UL RECOGNIZED (E37403), CSA CERTIFIED (701887)**

Q #	HP	rpm	price
G2870122	1/20	1550	<b>\$94.62</b>
G0835317	1/16	1550	<b>\$81.09</b>
G1124925	1/10	1550	<b>\$100.60</b>
G4261135	1/8	1050	<b>\$65.57</b>



**ICM Line Voltage Monitor**

- Protects 3 phase motors and equipment from voltage faults
- Manual or automatic reset
- 18 to 240 control volts
- 6A NC output
- 10A N.O. output
- 190-630 V

Q #	price
G2019771	<b>\$105.34</b>



**DAYTON 3.3" HVAC/R Motors**

- For direct drive fans and blowers
- Shaded pole OAO
- Continuous duty
- 115 V

Q #	HP	rpm	price
G0782625	1/16	3000	<b>\$55.07</b>
G2538322	1/20	1550	<b>\$50.88</b>
G1983572	1/40	1550	<b>\$44.61</b>
G1751084	1/60	1550	<b>\$47.64</b>

**ICM Plug-In Line Voltage Monitor**

- Protects 3 phase motors and equipment from voltage faults
- 3-phase
- NC 10 A resistive @ 250 VAC
- 10 A contact rating
- 190-480 VAC
- includes status LED

Q #	price
G2024337	<b>\$62.66</b>





# TOOLS



## TOP BRANDS



### SCREWDRIVERS

pg  
134



### WRENCHES

pg  
136



### TOOL BAGS

pg  
144



### TOOL BOXES

pg  
145



### MEASURING AND LAYOUT TOOLS

pg  
146



### POWER SAWS

pg  
147



### DRILLS AND DRIVERS

pg  
148



### SANDERS AND GRINDERS

pg  
150



### BATTERY PACKS AND CHARGERS

pg  
154



### DRILL BITS

pg  
156



**VAUGHAN Electrician's Straight Claw Hammer**

- High carbon steel head
- Fiberglass handle
- 14" overall length
- 18 oz head weight
- Smooth face

# price  
G1235787 **\$23.94**



**VAUGHAN Soft Face Hammer**

- Nylon tip
- Hickory handle
- 12½" overall length
- 12 oz head weight
- 4¾" head length

# price  
G1498533 **\$14.06**

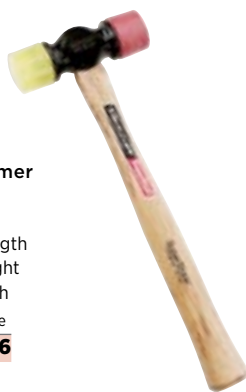

**VAUGHAN Welding Chipping Hammer**

- Steel head
- 11" overall length
- 14 oz head weight
- 7/8" blade length
- 7¾" head length

# price  
G3302817 **\$26.13**

**STANLEY Ball Pein Hammer**

- High carbon steel head
- Graphite handle
- 15" overall length
- 32 oz head weight
- Tether capable
- ■ ANSI STANDARDS

# price  
G1065364 **\$19.71**



**WESTWARD Rip Claw Hammer**

- Hardened carbon steel
- Fiberglass handle
- 13" overall length
- 16 oz head weight
- ■ ANSI STANDARDS

# price  
G3398884 **\$21.25**



**VAUGHAN Framing Hammer**

- Steel head
- Hickory handle
- 17¼" overall length
- 32 oz head weight
- ■ ANSI STANDARDS

# price  
G4397041 **\$24.92**

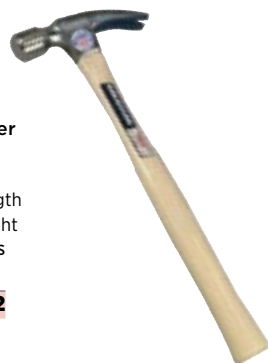

**VAUGHAN Tinnerns Riveting Hammer**

- High carbon steel head
- Hickory handle
- 14" overall length
- 12 oz head weight

# price  
G1409746 **\$15.70**



**STANLEY Hand Drilling Hammer**

- Steel head
- 11" overall length
- 3 lb head weight
- 1½" x 4" head
- FatMax AntiVibe

# price  
G0376372 **\$28.88**



**ARMSTRONG Brass Hammer**

- 12" overall length
- 1¼" face diameter
- 24 oz head weight
- Tether capable standard tool

# price  
G0789311 **\$48.01**



**PROTO Double Face Sledge Hammer**

- Forged steel head
- Fiberglass handle
- 14" overall length
- 2½ lb head weight
- Slip resistant cushion grip handle

# price  
G0318455 **\$40.66**



**STANLEY Dead Blow Hammers**

- Molded, steel shot inside head
- Polyurethane covered steel handle
- Tether capable standard tool

#	head weight	overall length	face diameter	head length	price
G2631797	10 oz	10"	1¼"	3¾"	<b>\$15.16</b>
G2665205	18 oz	11"	1¾"	3¾"	<b>\$18.61</b>
G0390275	21 oz	12¾"	2"	4¾"	<b>\$23.77</b>
G0788541	42 oz	14"	2½"	4¾"	<b>\$28.91</b>
G0754065	52 oz	16"	2¾"	5¾"	<b>\$41.24</b>

**STANLEY Engineers Hammer**

- Yellow, jacketed fiberglass
- 14" overall length
- 4 lb head weight
- 2" x 4¾" head
- Hardened and tempered forged steel

# price  
G1683516 **\$27.44**

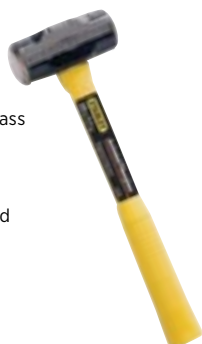

**VAUGHAN Linesman/Farriers Hammer**

- Steel head
- Hickory handle
- 3¾" head length
- Smooth face
- ■ AMSE STANDARDS

# price  
G0974111 **\$21.75**





# TOOLS

MORE THAN 800,000 ITEMS ONLINE

## WESTWARD Combination Screwdriver Set

- Acetate handles
- Hex and round shank shapes
- Assorted tips

includes keystone ( $\frac{3}{16}$ " x 3",  $\frac{3}{16}$ " x 4",  $\frac{3}{16}$ " x 4",  $\frac{3}{16}$ " x 8",  $\frac{1}{4}$ " x 1 $\frac{1}{2}$ ",  $\frac{1}{4}$ " x 4",  $\frac{1}{4}$ " x 6",  $\frac{1}{4}$ " x 12",  $\frac{3}{16}$ " x 8",  $\frac{3}{16}$ " x 12"), phillips (#0 x 3", #1 x 3", #2 x 1 $\frac{1}{2}$ ", #2 x 4", #2 x 8", #3 x 6", #4 x 8"), Torx (T10 x 4", T15 x 4", T20 x 4", T25 x 4", T30 x 4"), square (#1 x 4", #2 x 4"), precision ( $\frac{3}{32}$ " x 2"), phillips (#00 x 2"), 4-way pocket, offset keystone ( $\frac{3}{4}$ " / phillips #2) and scratch awl

**#** price  
G1374213 **\$97.94**

**29**  
PIECE



## WESTWARD Insulated Tool Set

- Protects against electrical shocks up to 1,000V

includes slotted ( $\frac{3}{32}$ " x 3",  $\frac{3}{16}$ " x 4",  $\frac{5}{32}$ " x 4",  $\frac{7}{32}$ " x 5",  $\frac{1}{4}$ " x 6",  $\frac{5}{16}$ " x 7",  $\frac{3}{8}$ " x 8"), phillips (#1 x 3 $\frac{3}{16}$ ", #2 x 4", #3 x 6") and nut drivers ( $\frac{1}{4}$ " x 5",  $\frac{5}{16}$ " x 5",  $\frac{3}{8}$ " x 5",  $\frac{7}{16}$ " x 5",  $\frac{1}{2}$ " x 5")

**#** price  
G0652005 **\$140.48**

**15**  
PIECE

## WERA Combination Screwdriver Set

- Multicomponent handle
- Alloy tool steel shank
- Assorted tip styles

includes keystone ( $\frac{3}{32}$ " x 4",  $\frac{1}{2}$ " x 6",  $\frac{3}{16}$ " x 4",  $\frac{1}{4}$ " x 5",  $\frac{2}{16}$ " x 6") and phillips (#1 x 3", #2 x 4")

**#** price  
G1592543 **\$41.01**

**7**  
PIECE



## WIHA TOOLS Insulated Screwdriver Set

- Chrome finish
- Ergonomic cushion grip handle
- CVM tool steel shank

includes keystone ( $\frac{3}{16}$ " x 4",  $\frac{3}{16}$ " x 5",  $\frac{1}{4}$ " x 6") and phillips (#1 x 3", #2 x 4", #3 x 6")

**#** price  
G1780161 **\$33.88**

**6**  
PIECE

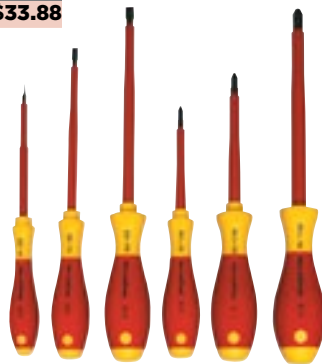

## KLEIN TOOLS Insulated Screwdriver Set

- Insulated over black oxide finish
- Acetate with cushion grip handle
- Alloy tool steel shank material

includes keystone  $\frac{1}{4}$ " x 4" and phillips #2 x 4"

**#** price  
G3051711 **\$36.62**

**2**  
PIECE



## WIHA TOOLS Electronics Screwdriver set

- CVM formulated steel
- Plastic handle
- Round shank
- Slotted and phillips tips

**#** price  
G3435975 **\$24.38**

**7**  
PIECE



## WESTWARD Combination Screwdriver Set

- Acetate handle
- Alloy tool steel shank
- Assorted tip styles

includes keystone ( $\frac{3}{16}$ " x 3",  $\frac{3}{16}$ " x 3",  $\frac{3}{16}$ " x 6",  $\frac{1}{4}$ " x 1 $\frac{1}{2}$ ",  $\frac{1}{4}$ " x 4",  $\frac{3}{16}$ " x 6"), phillips (#0 x 3", #1 x 3", #2 x 4", #2 x 1 $\frac{1}{2}$ ") and Torx (T15 x 3", T20 x 4")

**#** price  
G1844166 **\$45.77**

**12**  
PIECE



## KLEIN TOOLS Combination Screwdriver Set

- Acetate with cushion grip handle
- Alloy tool steel shank
- Assorted tip styles

includes keystone ( $\frac{1}{4}$ " x 4",  $\frac{3}{16}$ " x 6"), cabinet ( $\frac{3}{16}$ " x 3",  $\frac{3}{16}$ " x 6",  $\frac{1}{4}$ " x 4") and phillips (#1 x 3", #2 x 4")

**#** price  
G1789523 **\$50.94**

**7**  
PIECE



## GENERAL Jewelers Screwdriver Set

- Hardened steel blade
  - Plated steel handle
  - Round shank
- includes tip sizes 0.100, 0.080, 0.070, 0.055, 0.040, 0.025 slotted and #0 phillips blade and plastic tube storage with screw-on cap

**#** price  
G1425821 **\$26.23**

**7**  
PIECE





12  
PIECE

**WESTWARD Precision Screwdriver Set**

- Stainless steel
- Round shank
- Slotted tips

includes slotted (1.5, 1.8, 2.0, 2.5, 3.0), phillips (#000, 00, 0) and hex (3/64, 1/32, 1/16, 1/8)

Q#	price
G2983224	<b>\$29.80</b>



**PROTO Slotted Screwdrivers**

- Acetate handle
- Alloy steel shank
- Keystone slotted tip
- Standard tool tether capable
- ■ ANSI STANDARDS

Q#	tip size	shank	overall length	price
G0624513	3/4"	6"	10"	<b>\$7.71</b>
G2001343	5/16"	4"	8 3/8"	<b>\$12.12</b>
G2886947	3/8"	10"	15"	<b>\$13.09</b>



**GREENLEE 6-in-1 Multi-Bit Screwdriver**

- Chrome finish
- Alloy steel shank
- 7 1/8" overall length

• ■ ASME/ANSI STANDARDS  
includes 3/16", 1/4" slotted, #1, #2 phillips, 3/16", 1/4" hex bits and driver handle

Q#	price
G1654597	<b>\$7.20</b>



13  
PIECE

**WESTWARD Electronics Tool Set**

- Technician application

includes long nose, diagonal cut, end nose, bent nose and needle nose pliers, slotted 1.5, 1.8, 2.0, 2.5, 3.0 screwdrivers and phillips #000, #00, #0 screwdrivers

Q#	price
G1177443	<b>\$75.74</b>



**MEGAPRO Tamperproof Multi-Bit Screwdriver**

- Tamperproof oxide finish
- Steel shank
- 8 1/2" overall length
- 15-in-1 driver

includes hex pin (3/8" and 1/4", 5/32" and 3/16"), spanner (#6 and #8, #10 and #12), star pin (T10 and T15, T20 and T25, T27 and T30) and 1/4" hex nut driver

Q#	price
G0620356	<b>\$19.65</b>



**STANLEY Cabinet Screwdriver**

- Chrome finish
- Acetate handle
- Alloy steel shank
- 3/16" tip size
- 12" shank length

Q#	price
G0997342	<b>\$5.71</b>



**KLEIN TOOLS 10-in-1 Multi-Bit Screwdriver**

- Chrome finish
- Cushion grip handle
- Steel shank
- 15 3/4" overall length

Q#	price
G2056966	<b>\$12.31</b>



**MEGAPRO Megalok Multi-Bit Screwdriver**

- Quick change chuck
- 6 1/4" overall length
- 15-in-1

includes phillips (#0 & #3, #1 & #2), square (#0 & #3, #1 & #2), Star (T10 & T15, T20 & T25), slotted (#4 & #6) and 1/4" quick-change chuck

Q#	price
G1980045	<b>\$23.03</b>



**WERA Adjustable Torque Screwdriver**

- 6" overall length
- 1/4" drive size
- 2.5 to 11.5 in-lb primary scale range
- CW rotation
- ■ EN ISO 6789 STANDARDS

Q#	price
G0644393	<b>\$112.18</b>



**MEGAPRO 15-in-1 Multi-Bit Screwdriver**

- Chrome finish
- Engineered Nylon/ABS Resin and Triax 1120 handle
- Alloy steel shank
- 8 1/2" overall length

includes phillips (#0 and #3, #1 and #2), square (#0 and #3, #1 and #2), star (T10 and T15, T20 and T25) and slotted (#4 and #6) 3/4" hex nut driver shaft

Q#	price
G1832302	<b>\$18.51</b>



**KLEIN TOOLS Multi-Bit Screwdriver/Nutdriver**

- Chrome finish
- Steel shank
- 7 1/2" overall length
- 11-in-1

includes phillips (#1 and #2), slotted (3/4" and 5/8"), square recess (#1 and #2), torx (#10 and #15), 3/8", 5/16" and 1/4" nut drivers

Q#	price
G0949785	<b>\$13.70</b>



**UTICA Torque Screwdriver**

- Aluminum housing
- 6 1/2" overall length
- 1/4" drive size
- 6 to 30 in-lb primary scale range
- 1 in-lb primary scale increments

Q#	price
G1359321	<b>\$146.01</b>



# TOOLS

MORE THAN 800,000 ITEMS ONLINE

### WESTWARD Adjustable Wrench Set

- Drop-forged and heat treated alloy steel
- Cushion grip handle
- 1", 1½" jaw capacity
- 8", 10" overall length
- ■ ACME STANDARDS

Item #	price
G0342772	<b>\$28.39</b>



2 PIECE

### WESTWARD Adjustable Wrench Set

- Drop-forged and heat treated alloy steel
- Cushion grip handle
- ¾", 1", 1½" jaw capacity
- 6", 8", 10" overall length
- ■ ACME STANDARDS

Item #	price
G1277193	<b>\$51.54</b>



3 PIECE

### PROTO Black Plain Adjustable Wrenches

- Alloy steel
- Plain grip handle
- ■ ANSI SPECIFICATION B107.8M

Item #	jaw capacity	overall length	price
G1080956	½"	4"	<b>\$12.37</b>
G1675581	⅝"	6"	<b>\$12.63</b>
G1553054	1⅜"	8"	<b>\$16.75</b>



### PROTO Cushion Grip Adjustable Wrench

- Chrome finish
- Alloy steel
- 1½" jaw capacity
- 8" overall length
- ■ ANSI SPECIFICATION B107.8M

Item #	price
G3054527	<b>\$16.32</b>



### PROTO Combination Wrench Set

- Satin finish
- Antislip
- SAE
- 5⅜" to 16⅞" length range
- ■ ANSI STANDARDS

Item #	price
G3018906	<b>\$275.61</b>

15 PIECE

### WESTWARD Combination Wrench Set

- Satin finish
- 3<sup>25</sup>/<sub>32</sub>" to 15<sup>15</sup>/<sub>32</sub>" length range
- SAE and metric
- ■ ANSI STANDARDS

includes ¼", ⅜", ½", ⅝", ¾", 7/16", ½", ⅞", ⅝", 1⅜", ¾", 1⅝", 1", 1⅜", 1⅝", 7, 8, 9, 10, 11, 12, 13, 14, 15, 16, 17, 18, 19, 21, 22 and 24 mm wrenches

Item #	price
G1585893	<b>\$177.83</b>

32 PIECE



### PROTO Adjustable Wrench Set

- Drop forged and heat treated alloy steel
- Satin chrome finish
- Plain grip handle
- 1⅞", 1⅝", 1½" jaw capacity
- 8", 10", 12" overall length

Item #	price
G2001517	<b>\$61.42</b>

3 PIECE

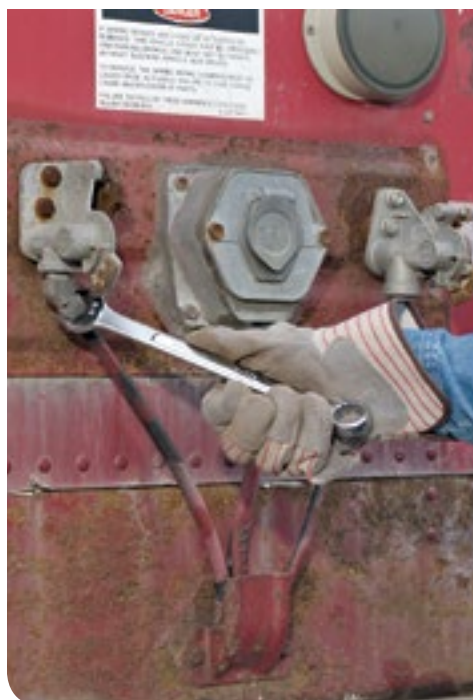

### WESTWARD Combination Wrench Sets

- Satin finish
  - 12 points
  - Standard tool tether capable
  - ■ ANSI STANDARDS
- includes vinyl pouch

**Metric**  
• 4¼" to 14⅝" length range  
includes 7, 8, 9, 10, 11, 12, 13, 14, 15, 16, 17, 18, 19, 21, 22, 24 and 27 mm wrench

Item #	price
G0786992	<b>\$84.33</b>

**SAE**  
• 4" to 16<sup>25</sup>/<sub>32</sub>" length range  
includes ¾", ⅞", 1⅜", 1⅝", ¾", 7/16", ½", ⅞", ⅝", 1⅜", 1⅝", ¾", 1⅝", 1", 1⅜", 1⅝" and 1¼" wrenches

Item #	price
G1301115	<b>\$113.63</b>

17 PIECE





**WESTWARD Crowfoot Wrench Set**

- Steel construction
  - SAE
  - 3/8" drive size
- includes 3/8", 7/16", 1/2", 9/16", 5/8", 11/16", 3/4", 13/16", 7/8" and 1" wrenches

#	price
G1259623	<b>\$98.65</b>



**PROTO Ratcheting Combo Wrench**

- Black chrome finish
- Vanadium steel
- Reversing
- SAE
- 7/32" x #7

#	price
G1528265	<b>\$10.04</b>



**AMPCO Non Sparking Double Open End Wrench**

- Aluminum bronze material
- Metric
- 19 x 22 mm
- 8" overall length
- FM APPROVED

#	price
G0663494	<b>\$66.09</b>



**AMPCO Striking Wrench**

- Aluminum bronze
- Straight handle
- SAE
- 9 7/8" overall length
- 1 1/16" size

#	price
G0713632	<b>\$119.85</b>



**FACOM Pin Spanner Wrench**

- Chrome vanadium steel
- 3 1/16" capacity
- 9 3/4" length
- 1 1/2" pin diameter
- 3/8" pin length

#	price
G4823192	<b>\$68.78</b>



**RIDGID Straight Pipe Wrenches**

- Forged steel jaw
- Aluminum I-Beam handle
- Standard with full floating hook
- Standard tool tether capable
- FEDERAL SPECIFICATION GGG-N651E, TYPE II CLASS A

#	jaw capacity	overall length	price
G2827806	1 1/2"	10"	<b>\$41.74</b>
G1422705	2"	12"	<b>\$49.97</b>



**WESTWARD Strap Wrench Set**

- Plastic handle
- Reinforced neoprene rubber strap
- 5 1/16" and 7 1/16" handle length
- 3 1/2" and 10" pipe capacity
- 4" and 12" outside diameter tubing
- 1 1/2" x 21" and 1 3/16" x 37 1/16" straps

#	price
G1274007	<b>\$31.54</b>



**RIDGID Strap Wrench**

- Aluminum I-Beam handle
- Woven nylon, polyurethane strap
- 1 3/4" x 29 1/4" strap
- 18" handle length
- 7" outside diameter tubing
- 5" pipe capacity

#	price
G0872277	<b>\$83.08</b>



**PROTO Micrometer Torque Wrench**

- Steel
- 1/2" drive size
- 50 to 250 ft-lb primary scale range
- 75 to 345 nm secondary scale range
- Tether capable
- ANSI STANDARDS

#	price
G1340437	<b>\$174.75</b>



**RIDGID Straight Pipe Wrenches**

- Forged steel jaw
- Cast iron I-Beam handle
- Full floating hook jaw with stationary heel jaw
- FEDERAL SPECIFICATION GGG-N661E, TYPE II, CLASS A

#	jaw capacity	overall length	price
G1244074	3/4"	6"	<b>\$13.38</b>
G1041756	8"	60"	<b>\$277.73</b>



**MILWAUKEE Face Spanner Wrench**

- Black oxide finish
- Metal

#	price
G4328396	<b>\$5.66</b>





# TOOLS



### IRWIN VISE-GRIP Curved Jaw Locking Pliers

- Nickel plated steel
- Wire cutter
- Plain grip handle
- Standard tool tether capable

Item #	jaw capacity	jaw thickness	overall length	price
G2617693	1"	3/8"	4"	<b>\$6.27</b>
G1382211	1 1/2"	3/4"	5"	<b>\$6.89</b>
G2836592	1 1/2"	5/8"	7"	<b>\$7.84</b>
G0671501	1 1/2"	3/8"	10"	<b>\$7.92</b>



### IRWIN VISE-GRIP Large Capacity Locking Pliers

- Nickel plated steel
- Plain grip handle
- 12" length
- 3 1/8" jaw capacity
- Standard tool tether capable

Item #	price
G1235087	<b>\$13.73</b>

### IRWIN VISE-GRIP Convertible Retaining Ring Pliers

- Chrome vanadium
- Protouch grips
- Cushion grip handle
- Fixed tip
- .049" and .070" tip size
- 6 1/2" overall length

Item #	price
G2834404	<b>\$9.31</b>

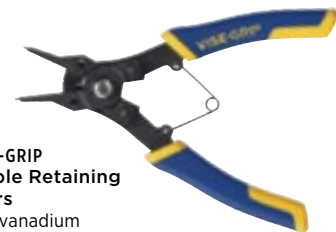

### WESTWARD Locking Pliers Set

- Ergonomic handle
- 5", 6", 7", 10" length
- Standard tool tether capable
- includes 6" long nose, 10" straight jaw, 5", 7" and 10" curved jaw*

Item #	price
G0693551	<b>\$65.24</b>



### STA-KON Insulated crimper

- 22 to 10 AWG
- 9 5/8" overall length
- For installing A,B, C, pt. non insulated terminals and splices
- includes wire cutter, wire stripper, screw cutter and insulated grips*

Item #	price
G2486626	<b>\$39.92</b>



### CHANNELLOCK Long Nose Pliers

- Drop forged steel
- Ergonomic handle
- 8" overall length
- Smooth jaw
- Straight nose

Item #	price
G1715831	<b>\$15.41</b>



### STA-KON Ratcheting Crimper

- 22 to 10 AWG capacity
- 10 1/2" overall length
- Ergonomic handle
- includes color-coded die nests, die embossment and terminal locator*

Item #	price
G1493816	<b>\$198.16</b>



### KNIPEX Water Pump Pliers Set

- Chrome vanadium steel
- Dipped handle
- includes 7 1/2", 10", and 12" alligator slide groove pliers and molded plastic tray*

Item #	price
G2776821	<b>\$66.90</b>



### KLEIN TOOLS Diagonal Cutters

- Steel
- Ergonomic handle
- 8 1/8" overall length
- 1 3/16" jaw length
- 1 3/16" jaw width

Item #	price
G1878256	<b>\$33.11</b>



### CHANNELLOCK Tongue and Groove Pliers

- Forged alloy steel
- Polished finish
- Straight jaw
- Dipped handle
- ■ ANSI B107.23

Item #	jaw capacity	overall length	price
G1776284	7/8"	6 1/2"	<b>\$9.17</b>
G0842432	1 1/2"	9 1/2"	<b>\$11.92</b>
G3146403	2"	10"	<b>\$12.05</b>
G2370575	2 3/4"	12"	<b>\$13.07</b>
G1538582	4 1/4"	16 1/2"	<b>\$21.70</b>



### XCELITE Shear Cutter

- Copper alloy rivet
- Plastisol, nonslip cushion handle
- Spring handle

Item #	price
G1514037	<b>\$5.81</b>





**PROTO Metric Socket Bit Set**

- Full polished chrome finish
- Alloy steel
- 3/8", 1/2" drive size
- Hex tip

*includes 3/8" drive: 4, 5, 6, 7, 8, 9, 10 mm sockets, 1/2" drive: 12, 14, 17 mm sockets and case*

#	price
G1378867	<b>\$89.82</b>

10  
PIECE



**WESTWARD Socket and Wrench Set**

- SAE and metric
- 1/4", 3/8", 1/2" drive size
- 6 and 12 standard socket point styles
- 6 and 12 deep socket point styles

*includes 1/4" drive quick-release ratchet (5 1/2" length), 3" extension bar 3/8" drive: quick-release ratchet (7 3/4" length), 3" extension bar, 3/8" spark plug socket, 1/16" spark plug socket 1/2" drive: quick-release ratchet (8 3/4" length), 5" extension bar, and blow molded case 1/4" drive — 6 pt. std.: 3/32", 1/16", 1/32", 1/4", 3/32", 3/16", 1/32", 3/8", 7/16", 1/2" and 4 mm, 4.5 mm, 5 mm, 5.5 mm, 6 mm, 7 mm, 8 mm, 9 mm, 10 mm, 11 mm, 12 mm, 13 mm, 6 pt. deep: 3/16", 3/8", 1/2", 5/8", 12 pt. standard: 3/16", 1/8", 1/4", 3/8", 1/2", 5/8", 3/4", 7/8", 1 1/8", 1 1/4", 1 1/2", 1 3/4", 2", 2 1/4", 2 1/2", 2 3/4", 3", 3 1/4", 3 1/2", 3 3/4", 4", 4 1/4", 4 1/2", 4 3/4", 5", 5 1/4", 5 1/2", 5 3/4", 6", 6 1/4", 6 1/2", 6 3/4", 7", 7 1/4", 7 1/2", 7 3/4", 8", 8 1/4", 8 1/2", 8 3/4", 9", 9 1/4", 9 1/2", 9 3/4", 10", 10 1/4", 10 1/2", 10 3/4", 11", 11 1/4", 11 1/2", 11 3/4", 12", 12 1/4", 12 1/2", 12 3/4", 13", 13 1/4", 13 1/2", 13 3/4", 14", 14 1/4", 14 1/2", 14 3/4", 15", 15 1/4", 15 1/2", 15 3/4", 16", 16 1/4", 16 1/2", 16 3/4", 17", 17 1/4", 17 1/2", 17 3/4", 18", 18 1/4", 18 1/2", 18 3/4", 19", 19 1/4", 19 1/2", 19 3/4", 20", 20 1/4", 20 1/2", 20 3/4", 21", 21 1/4", 21 1/2", 21 3/4", 22", 22 1/4", 22 1/2", 22 3/4", 23", 23 1/4", 23 1/2", 23 3/4", 24", 24 1/4", 24 1/2", 24 3/4", 25", 25 1/4", 25 1/2", 25 3/4", 26", 26 1/4", 26 1/2", 26 3/4", 27", 27 1/4", 27 1/2", 27 3/4", 28", 28 1/4", 28 1/2", 28 3/4", 29", 29 1/4", 29 1/2", 29 3/4", 30", 30 1/4", 30 1/2", 30 3/4", 31", 31 1/4", 31 1/2", 31 3/4", 32", 32 1/4", 32 1/2", 32 3/4", 33", 33 1/4", 33 1/2", 33 3/4", 34", 34 1/4", 34 1/2", 34 3/4", 35", 35 1/4", 35 1/2", 35 3/4", 36", 36 1/4", 36 1/2", 36 3/4", 37", 37 1/4", 37 1/2", 37 3/4", 38", 38 1/4", 38 1/2", 38 3/4", 39", 39 1/4", 39 1/2", 39 3/4", 40", 40 1/4", 40 1/2", 40 3/4", 41", 41 1/4", 41 1/2", 41 3/4", 42", 42 1/4", 42 1/2", 42 3/4", 43", 43 1/4", 43 1/2", 43 3/4", 44", 44 1/4", 44 1/2", 44 3/4", 45", 45 1/4", 45 1/2", 45 3/4", 46", 46 1/4", 46 1/2", 46 3/4", 47", 47 1/4", 47 1/2", 47 3/4", 48", 48 1/4", 48 1/2", 48 3/4", 49", 49 1/4", 49 1/2", 49 3/4", 50", 50 1/4", 50 1/2", 50 3/4", 51", 51 1/4", 51 1/2", 51 3/4", 52", 52 1/4", 52 1/2", 52 3/4", 53", 53 1/4", 53 1/2", 53 3/4", 54", 54 1/4", 54 1/2", 54 3/4", 55", 55 1/4", 55 1/2", 55 3/4", 56", 56 1/4", 56 1/2", 56 3/4", 57", 57 1/4", 57 1/2", 57 3/4", 58", 58 1/4", 58 1/2", 58 3/4", 59", 59 1/4", 59 1/2", 59 3/4", 60", 60 1/4", 60 1/2", 60 3/4", 61", 61 1/4", 61 1/2", 61 3/4", 62", 62 1/4", 62 1/2", 62 3/4", 63", 63 1/4", 63 1/2", 63 3/4", 64", 64 1/4", 64 1/2", 64 3/4", 65", 65 1/4", 65 1/2", 65 3/4", 66", 66 1/4", 66 1/2", 66 3/4", 67", 67 1/4", 67 1/2", 67 3/4", 68", 68 1/4", 68 1/2", 68 3/4", 69", 69 1/4", 69 1/2", 69 3/4", 70", 70 1/4", 70 1/2", 70 3/4", 71", 71 1/4", 71 1/2", 71 3/4", 72", 72 1/4", 72 1/2", 72 3/4", 73", 73 1/4", 73 1/2", 73 3/4", 74", 74 1/4", 74 1/2", 74 3/4", 75", 75 1/4", 75 1/2", 75 3/4", 76", 76 1/4", 76 1/2", 76 3/4", 77", 77 1/4", 77 1/2", 77 3/4", 78", 78 1/4", 78 1/2", 78 3/4", 79", 79 1/4", 79 1/2", 79 3/4", 80", 80 1/4", 80 1/2", 80 3/4", 81", 81 1/4", 81 1/2", 81 3/4", 82", 82 1/4", 82 1/2", 82 3/4, 83", 83 1/4", 83 1/2", 83 3/4, 84", 84 1/4", 84 1/2", 84 3/4, 85", 85 1/4", 85 1/2", 85 3/4, 86", 86 1/4", 86 1/2", 86 3/4, 87", 87 1/4", 87 1/2", 87 3/4, 88", 88 1/4", 88 1/2", 88 3/4, 89", 89 1/4", 89 1/2", 89 3/4, 90", 90 1/4", 90 1/2", 90 3/4, 91", 91 1/4", 91 1/2", 91 3/4, 92", 92 1/4", 92 1/2", 92 3/4, 93", 93 1/4", 93 1/2", 93 3/4, 94", 94 1/4", 94 1/2", 94 3/4, 95", 95 1/4", 95 1/2", 95 3/4, 96", 96 1/4", 96 1/2", 96 3/4, 97", 97 1/4", 97 1/2", 97 3/4, 98", 98 1/4", 98 1/2", 98 3/4, 99", 99 1/4", 99 1/2", 99 3/4, 100", 100 1/4", 100 1/2", 100 3/4, 101", 101 1/4", 101 1/2", 101 3/4, 102", 102 1/4", 102 1/2", 102 3/4, 103", 103 1/4", 103 1/2", 103 3/4, 104", 104 1/4", 104 1/2", 104 3/4, 105", 105 1/4", 105 1/2", 105 3/4, 106", 106 1/4", 106 1/2", 106 3/4, 107", 107 1/4", 107 1/2", 107 3/4, 108", 108 1/4", 108 1/2", 108 3/4, 109", 109 1/4", 109 1/2", 109 3/4, 110", 110 1/4", 110 1/2", 110 3/4, 111", 111 1/4", 111 1/2", 111 3/4, 112", 112 1/4", 112 1/2", 112 3/4, 113", 113 1/4", 113 1/2", 113 3/4, 114", 114 1/4", 114 1/2", 114 3/4, 115", 115 1/4", 115 1/2", 115 3/4, 116", 116 1/4", 116 1/2", 116 3/4, 117", 117 1/4", 117 1/2", 117 3/4, 118", 118 1/4", 118 1/2", 118 3/4, 119", 119 1/4", 119 1/2", 119 3/4, 120", 120 1/4", 120 1/2", 120 3/4, 121", 121 1/4", 121 1/2", 121 3/4, 122", 122 1/4", 122 1/2", 122 3/4, 123", 123 1/4", 123 1/2", 123 3/4, 124", 124 1/4", 124 1/2", 124 3/4, 125", 125 1/4", 125 1/2", 125 3/4, 126", 126 1/4", 126 1/2", 126 3/4, 127", 127 1/4", 127 1/2", 127 3/4, 128", 128 1/4", 128 1/2", 128 3/4, 129", 129 1/4", 129 1/2", 129 3/4, 130", 130 1/4", 130 1/2", 130 3/4, 131", 131 1/4", 131 1/2", 131 3/4, 132", 132 1/4", 132 1/2", 132 3/4, 133", 133 1/4", 133 1/2", 133 3/4, 134", 134 1/4", 134 1/2", 134 3/4, 135", 135 1/4", 135 1/2", 135 3/4, 136", 136 1/4", 136 1/2", 136 3/4, 137", 137 1/4", 137 1/2", 137 3/4, 138", 138 1/4", 138 1/2", 138 3/4, 139", 139 1/4", 139 1/2", 139 3/4, 140", 140 1/4", 140 1/2", 140 3/4, 141", 141 1/4", 141 1/2", 141 3/4, 142", 142 1/4", 142 1/2", 142 3/4, 143", 143 1/4", 143 1/2", 143 3/4, 144", 144 1/4", 144 1/2", 144 3/4, 145", 145 1/4", 145 1/2", 145 3/4, 146", 146 1/4", 146 1/2", 146 3/4, 147", 147 1/4", 147 1/2", 147 3/4, 148", 148 1/4", 148 1/2", 148 3/4, 149", 149 1/4", 149 1/2", 149 3/4, 150", 150 1/4", 150 1/2", 150 3/4, 151", 151 1/4", 151 1/2", 151 3/4, 152", 152 1/4", 152 1/2", 152 3/4, 153", 153 1/4", 153 1/2", 153 3/4, 154", 154 1/4", 154 1/2", 154 3/4, 155", 155 1/4", 155 1/2", 155 3/4, 156", 156 1/4", 156 1/2", 156 3/4, 157", 157 1/4", 157 1/2", 157 3/4, 158", 158 1/4", 158 1/2", 158 3/4, 159", 159 1/4", 159 1/2", 159 3/4, 160", 160 1/4", 160 1/2", 160 3/4, 161", 161 1/4", 161 1/2", 161 3/4, 162", 162 1/4", 162 1/2", 162 3/4, 163", 163 1/4", 163 1/2", 163 3/4, 164", 164 1/4", 164 1/2", 164 3/4, 165", 165 1/4", 165 1/2", 165 3/4, 166", 166 1/4", 166 1/2", 166 3/4, 167", 167 1/4", 167 1/2", 167 3/4, 168", 168 1/4", 168 1/2", 168 3/4, 169", 169 1/4", 169 1/2", 169 3/4, 170", 170 1/4", 170 1/2", 170 3/4, 171", 171 1/4", 171 1/2", 171 3/4, 172", 172 1/4", 172 1/2", 172 3/4, 173", 173 1/4", 173 1/2", 173 3/4, 174", 174 1/4", 174 1/2", 174 3/4, 175", 175 1/4", 175 1/2", 175 3/4, 176", 176 1/4", 176 1/2", 176 3/4, 177", 177 1/4", 177 1/2", 177 3/4, 178", 178 1/4", 178 1/2", 178 3/4, 179", 179 1/4", 179 1/2", 179 3/4, 180", 180 1/4", 180 1/2", 180 3/4, 181", 181 1/4", 181 1/2", 181 3/4, 182", 182 1/4", 182 1/2", 182 3/4, 183", 183 1/4", 183 1/2", 183 3/4, 184", 184 1/4", 184 1/2", 184 3/4, 185", 185 1/4", 185 1/2", 185 3/4, 186", 186 1/4", 186 1/2", 186 3/4, 187", 187 1/4", 187 1/2", 187 3/4, 188", 188 1/4", 188 1/2", 188 3/4, 189", 189 1/4", 189 1/2", 189 3/4, 190", 190 1/4", 190 1/2", 190 3/4, 191", 191 1/4", 191 1/2", 191 3/4, 192", 192 1/4", 192 1/2", 192 3/4, 193", 193 1/4", 193 1/2", 193 3/4, 194", 194 1/4", 194 1/2", 194 3/4, 195", 195 1/4", 195 1/2", 195 3/4, 196", 196 1/4", 196 1/2", 196 3/4, 197", 197 1/4", 197 1/2", 197 3/4, 198", 198 1/4", 198 1/2", 198 3/4, 199", 199 1/4", 199 1/2", 199 3/4, 200", 200 1/4", 200 1/2", 200 3/4, 201", 201 1/4", 201 1/2", 201 3/4, 202", 202 1/4", 202 1/2", 202 3/4, 203", 203 1/4", 203 1/2", 203 3/4, 204", 204 1/4", 204 1/2", 204 3/4, 205", 205 1/4", 205 1/2", 205 3/4, 206", 206 1/4", 206 1/2", 206 3/4, 207", 207 1/4", 207 1/2", 207 3/4, 208", 208 1/4", 208 1/2", 208 3/4, 209", 209 1/4", 209 1/2", 209 3/4, 210", 210 1/4", 210 1/2", 210 3/4, 211", 211 1/4", 211 1/2", 211 3/4, 212", 212 1/4", 212 1/2", 212 3/4, 213", 213 1/4", 213 1/2", 213 3/4, 214", 214 1/4", 214 1/2", 214 3/4, 215", 215 1/4", 215 1/2", 215 3/4, 216", 216 1/4", 216 1/2", 216 3/4, 217", 217 1/4", 217 1/2", 217 3/4, 218", 218 1/4", 218 1/2", 218 3/4, 219", 219 1/4", 219 1/2", 219 3/4, 220", 220 1/4", 220 1/2", 220 3/4, 221", 221 1/4", 221 1/2", 221 3/4, 222", 222 1/4", 222 1/2", 222 3/4, 223", 223 1/4", 223 1/2", 223 3/4, 224", 224 1/4", 224 1/2", 224 3/4, 225", 225 1/4", 225 1/2", 225 3/4, 226", 226 1/4", 226 1/2", 226 3/4, 227", 227 1/4", 227 1/2", 227 3/4, 228", 228 1/4", 228 1/2", 228 3/4, 229", 229 1/4", 229 1/2", 229 3/4, 230", 230 1/4", 230 1/2", 230 3/4, 231", 231 1/4", 231 1/2", 231 3/4, 232", 232 1/4", 232 1/2", 232 3/4, 233", 233 1/4", 233 1/2", 233 3/4, 234", 234 1/4", 234 1/2", 234 3/4, 235", 235 1/4", 235 1/2", 235 3/4, 236", 236 1/4", 236 1/2", 236 3/4, 237", 237 1/4", 237 1/2", 237 3/4, 238", 238 1/4", 238 1/2", 238 3/4, 239", 239 1/4", 239 1/2", 239 3/4, 240", 240 1/4", 240 1/2", 240 3/4, 241", 241 1/4", 241 1/2", 241 3/4, 242", 242 1/4", 242 1/2", 242 3/4, 243", 243 1/4", 243 1/2", 243 3/4, 244", 244 1/4", 244 1/2", 244 3/4, 245", 245 1/4", 245 1/2", 245 3/4, 246", 246 1/4", 246 1/2", 246 3/4, 247", 247 1/4", 247 1/2", 247 3/4, 248", 248 1/4", 248 1/2", 248 3/4, 249", 249 1/4", 249 1/2", 249 3/4, 250", 250 1/4", 250 1/2", 250 3/4, 251", 251 1/4", 251 1/2", 251 3/4, 252", 252 1/4", 252 1/2", 252 3/4, 253", 253 1/4", 253 1/2", 253 3/4, 254", 254 1/4", 254 1/2", 254 3/4, 255", 255 1/4", 255 1/2", 255 3/4, 256", 256 1/4", 256 1/2", 256 3/4, 257", 257 1/4", 257 1/2", 257 3/4, 258", 258 1/4", 258 1/2", 258 3/4, 259", 259 1/4", 259 1/2", 259 3/4, 260", 260 1/4", 260 1/2", 260 3/4, 261", 261 1/4", 261 1/2", 261 3/4, 262", 262 1/4", 262 1/2", 262 3/4, 263", 263 1/4", 263 1/2", 263 3/4, 264", 264 1/4", 264 1/2", 264 3/4, 265", 265 1/4", 265 1/2", 265 3/4, 266", 266 1/4", 266 1/2", 266 3/4, 267", 267 1/4", 267 1/2", 267 3/4, 268", 268 1/4", 268 1/2", 268 3/4, 269", 269 1/4", 269 1/2", 269 3/4, 270", 270 1/4", 270 1/2", 270 3/4, 271", 271 1/4", 271 1/2", 271 3/4, 272", 272 1/4", 272 1/2", 272 3/4, 273", 273 1/4", 273 1/2", 273 3/4, 274", 274 1/4", 274 1/2", 274 3/4, 275", 275 1/4", 275 1/2", 275 3/4, 276", 276 1/4", 276 1/2", 276 3/4, 277", 277 1/4", 277 1/2", 277 3/4, 278", 278 1/4", 278 1/2", 278 3/4, 279", 279 1/4", 279 1/2", 279 3/4, 280", 280 1/4", 280 1/2", 280 3/4, 281", 281 1/4", 281 1/2", 281 3/4, 282", 282 1/4", 282 1/2", 282 3/4, 283", 283 1/4", 283 1/2", 283 3/4, 284", 284 1/4", 284 1/2", 284 3/4, 285", 285 1/4", 285 1/2", 285 3/4, 286", 286 1/4", 286 1/2", 286 3/4, 287", 287 1/4", 287 1/2", 287 3/4, 288", 288 1/4", 288 1/2", 288 3/4, 289", 289 1/4", 289 1/2", 289 3/4, 290", 290 1/4", 290 1/2", 290 3/4, 291", 291 1/4", 291 1/2", 291 3/4, 292", 292 1/4", 292 1/2", 292 3/4, 293", 293 1/4", 293 1/2", 293 3/4, 294", 294 1/4", 294 1/2", 294 3/4, 295", 295 1/4", 295 1/2", 295 3/4, 296", 296 1/4", 296 1/2", 296 3/4, 297", 297 1/4", 297 1/2", 297 3/4, 298", 298 1/4", 298 1/2", 298 3/4, 299", 299 1/4", 299 1/2", 299 3/4, 300", 300 1/4", 300 1/2", 300 3/4, 301", 301 1/4", 301 1/2", 301 3/4, 302", 302 1/4", 302 1/2", 302 3/4, 303", 303 1/4", 303 1/2", 303 3/4, 304", 304 1/4", 304 1/2", 304 3/4, 305", 305 1/4", 305 1/2", 305 3/4, 306", 306 1/4", 306 1/2", 306 3/4, 307", 307 1/4", 307 1/2", 307 3/4, 308", 308 1/4", 308 1/2", 308 3/4, 309", 309 1/4", 309 1/2", 309 3/4, 310", 310 1/4", 310 1/2", 310 3/4, 311", 311 1/4", 311 1/2", 311 3/4, 312", 312 1/4", 312 1/2", 312 3/4, 313", 313 1/4", 313 1/2", 313 3/4, 314", 314 1/4", 314 1/2", 314 3/4, 315", 315 1/4", 315 1/2", 315 3/4, 316", 316 1/4", 316 1/2", 316 3/4, 317", 317 1/4", 317 1/2", 317 3/4, 318", 318 1/4", 318 1/2", 318 3/4, 319", 319 1/4", 319 1/2", 319 3/4, 320", 320 1/4", 320 1/2", 320 3/4, 321", 321 1/4", 321 1/2", 321 3/4, 322", 322 1/4", 322 1/2", 322 3/4, 323", 323 1/4", 323 1/2", 323 3/4, 324", 324 1/4", 324 1/2", 324 3/4, 325", 325 1/4", 325 1/2", 325 3/4, 326", 326 1/4", 326 1/2", 326 3/4, 327", 327 1/4", 327 1/2", 327 3/4, 328", 328 1/4", 328 1/2", 328 3/4, 329", 329 1/4", 329 1/2", 329 3/4, 330", 330 1/4", 330 1/2", 330 3/4, 331", 331 1/4", 331 1/2", 331 3/4, 332", 332 1/4", 332 1/2", 332 3/4, 333", 333 1/4", 333 1/2", 333 3/4, 334", 334 1/4", 334 1/2", 334 3/4, 335", 335 1/4", 335 1/2", 335 3/4, 336", 336 1/4", 336 1/2", 336 3/4, 337", 337 1/4", 337 1/2", 337 3/4, 338", 338 1/4", 338 1/2", 338 3/4, 339", 339 1/4", 339 1/2", 339 3/4, 340", 340 1/4", 340 1/2", 340 3/4, 341", 341 1/4", 341 1/2", 341 3/4, 342", 342 1/4", 342 1/2", 342 3/4, 343", 343 1/4", 343 1/2", 343 3/4, 344", 344 1/4", 344 1/2", 344 3/4, 345", 345 1/4", 345 1/2", 345 3/4, 346", 346 1/4", 346 1/2", 346 3/4, 347", 347 1/4", 347 1/2", 347 3/4, 348", 348 1/4", 348 1/2", 348 3/4, 349", 349 1/4", 349 1/2", 349 3/4, 350", 350 1/4", 350 1/2", 350 3/4, 351", 351 1/4", 351 1/2", 351 3/4, 352", 352 1/4", 352 1/2", 352 3/4, 353", 353 1/4", 353 1/2", 353 3/4, 354", 354 1/4", 354 1/2", 354 3/4, 355", 355 1/4", 355 1/2", 355 3/4, 356", 356 1/4", 356 1/2", 356 3/4, 357", 357 1/4", 357 1/2", 357 3/4, 358", 358 1/4", 358 1/2", 358 3/4, 359", 359 1/4", 359 1/2", 359 3/4, 360", 360 1/4", 360 1/2", 360 3/4, 361", 361 1/4", 361 1/2", 361 3/4, 362", 362 1/4", 362 1/2", 362 3/4, 363", 363 1/4", 363 1/2", 363 3/4, 364", 364 1/4", 364 1/2", 364 3/4, 365", 365 1/4", 365 1/2", 365 3/4, 366", 366 1/4", 366 1/2", 366 3/4, 367", 367 1/4", 367 1/2", 367 3/4, 368", 368 1/4", 368 1/2", 368 3/4, 369", 369 1/4", 369 1/2", 369 3/4, 370", 370 1/4", 370 1/2", 370 3/4, 371", 371 1/4", 371 1/2", 371 3/4, 372", 372 1/4", 372 1/2", 372 3/4, 373", 373 1/4", 373 1/2", 373*



# TOOLS

MORE THAN 800,000 ITEMS ONLINE



### LENOX Hacksaw Blades

- Bi-metal
- Tuff tooth
- 12" x 1/2"
- .023" thickness
- 10 pack

Z#	TPI	price
G0797386	18	<b>\$11.70</b>
G0367857	24	<b>\$12.01</b>
G2059531	32	<b>\$13.07</b>

### STOREHORSE Folding Saw Horse

- 14 gauge galvanized steel
- 31" w x 21" l x 28 1/2" h
- 500 lb each hold capacity
- Folding legs
- Carrying handle

Z#	price
G0826007	<b>\$20.80</b>



### WESTWARD Jab Saw

- Polypropylene, TPR handle
- 12" length
- 6" x 3/4" blade
- 8 TPI
- 3 mm kerf

Z#	price
G5153741	<b>\$14.82</b>

### STANLEY Hacksaw

- 12" blade length
- 3 7/8" throat depth
- Standard tool tether capable
- Holds 12" blade at up to 32,000 psi
- Fully adjustable tension

Z#	price
G2775001	<b>\$19.75</b>



### LENOX Hacksaw Frame

- D-shape, rubberized handle
- 16" length
- 12" blade length
- High tension, 50,000 psi
- 24 TPI

Z#	price
G1786154	<b>\$20.92</b>

### WESTWARD Hacksaw Kit

- 10" and 12" blade length
- Standard tool tether capable
- Provided longer blade life and fast, accurate cuts
- Fully adjustable tension

Z#	price
G0378034	<b>\$29.55</b>



### STANLEY Folding Pocket Saw

- 10 TPI
- Standard tool tether capable

Z#	price
G7565984	<b>\$7.64</b>



### WESTWARD PVC Saw

- Aluminum alloy TPR handle
- 16" length
- 12" x 2 1/2" blade
- Standard stool tether capable

Z#	price
G5153784	<b>\$22.74</b>



### WESTWARD Junior Saw With Blade Tensioning

- Steel wire with finger guard
- 9 3/4" length
- 6" blade length
- Standard stool tether capable
- 32 TPI

Z#	price
G0548405	<b>\$3.27</b>

### STANLEY Keyhole Saw

- 4-way
- Standard tool tether capable
- Lightweight pistol grip handle

includes one metal blade and one wood blade

Z#	price
G7491163	<b>\$4.67</b>



### WESTWARD Crosscut Saw

- 18 1/2" length
- 15" blade length
- 9 TPI

includes high carbon steel blade

Z#	price
G0470793	<b>\$11.52</b>



### WESTWARD Undercut Saw

- 18 3/4" length
- 12" blade length
- 10 TPI
- High carbon steel blade

Z#	price
G5532493	<b>\$28.68</b>



**GREENLEE Hole Punch Set**

- Mild steel
  - 1/2" to 1 1/4" conduit and pipe size
  - 10 ga steel capacity
- includes 1/2", 3/4", 1", 1 1/4" slug buster punches and dies, draw studs and plastic carrying case*

**#** price  
G1705137 **\$135.74**

10  
PIECE

7  
PIECE

**GENERAL Arch Punch Set**

- Heat treated steel
  - 4" length
  - 1 piece punch design
  - Max 10 ga steel
- includes sizes 1/4", 3/8", 1/2", 5/8", 3/4", 7/8", 1" and plastic roll case*

**#** price  
G2673081 **\$58.83**



**GREENLEE**

**Hole Punch Set**

- Mild steel
  - 1/2" to 1 1/4" conduit and pipe size
  - 10 ga steel capacity
- includes 1/2", 3/4", 1", 1 1/4" slug buster punches and dies, draw studs and plastic carrying case*

**#** price  
G1705137 **\$135.74**

10  
PIECE

**GREENLEE Knockout Punch**

- .885" hole size nominal
- 7/8" hole size
- 1/2" conduit and pipe size
- 10 ga mild steel max capacity
- Slug splits in half, falls free from die and stud

**#** price  
G1088071 **\$30.58**



**GREENLEE Knockout Punch Driver Set**

- Mild steel
  - 1/2" to 2" conduit and pipe size
  - 10 ga steel capacity
- includes 1" hex head ratchet wrench, 1/2", 3/4", 1", 1 1/4", 1 1/2", 2" slug buster punches and dies, draw studs and plastic carrying case*

**#** price  
G1453986 **\$298.01**

15  
PIECE

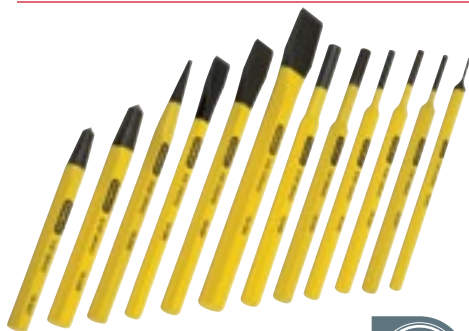

**STANLEY Punch and Chisel Set**

- Hardened steel
  - Black oxide finish
  - 6" length
- includes 3/4", 5/16", 3/32", 3/16", 1/8", 5/32", 3/16", 3/4", 1/2", 5/16", 3/8", 1/2", 5/8"*

**#** price  
G2196695 **\$21.96**

12  
PIECE



**DASCO PRO Roll Pin Punch**

- High carbon steel
- Heat treated
- 3" length
- 1/16" tip size, 1/4" hex

**#** price  
G4625932 **\$2.70**



**STARRETT Drive Pin Punch**

- Hardened steel
- 4" length
- 1/16" tip size
- Knurled
- Standard tool tether capable

**#** price  
G2507382 **\$5.60**



**STARRETT Automatic Center Punch**

- Aluminum handle, high carbon steel point
- 5" length
- 5/8" diameter
- Adjustable
- Replaceable point

**#** price  
G0562511 **\$35.31**



**MAYHEW Hollow Punch Set**

- Alloy steel
  - 9" length
  - 1 piece punch design
- includes 3/8", 1/2", 3/4", 5/8", 3/4", 1/2", 1/2", 3/16", 3/8", 1/2", 3/4", 1", 1 1/8", 1 1/2", 1 3/4"*

**#** price  
G1330901 **\$161.31**

16  
PIECE

**WESTWARD Transfer Punch Set**

- A matched set of precision-transfer punches allows the transferring of threaded, drilled, or reamed holes

*includes metal stand*

**#** price  
G4794702 **\$29.22**

28  
PIECE





# TOOLS

MORE THAN 800,000 ITEMS ONLINE

## WESTWARD Spring Clamps

- Steel
- Polyvinyl handle and tip

Item #	size	max jaw opening	length	price
G2740796	1"	1"	4"	<b>\$2.92</b>
G0936467	2"	2"	6"	<b>\$4.39</b>
G1288287	3"	3"	9"	<b>\$8.86</b>



## WILTON Portable Vise

- Ductile iron
- 4" jaw width
- 2 1/4" max opening
- 2" throat depth
- Clamp-on swivel

Item #	price
G2471637	<b>\$115.28</b>

## IRWIN VISE-GRIP Locking Chain Clamp

- Nickel plated finish
- Alloy steel
- 9" size
- Easy release trigger, micro-adjustment

Item #	price
G0464222	<b>\$17.92</b>



## IRWIN VISE-GRIP Locking Sheet Metal Clamp

- Nickel plated finish
- Alloy steel
- 8" size
- 1 1/4" throat depth
- 3 1/8" jaw width

Item #	price
G1913922	<b>\$16.86</b>



## WESTWARD Mechanic's Vise

- Ductile iron
- 5" jaw width
- 5" max opening
- 2 1/2" throat depth
- Swivel base

Item #	price
G1664424	<b>\$70.76</b>



## IRWIN VISE-GRIP Locking C-Clamps

- Nickel plated finish
- Alloy steel
- For welding sheet metal or woodwork
- ■ GOVERNMENT SPECIFICATIONS GGG-W-00649

Item #	capacity	throat depth	plier length	price
G2350853	2 3/4"	1 1/2"	6"	<b>\$7.71</b>
G3017637	3 3/4"	2 3/8"	11"	<b>\$14.42</b>

## IRWIN QUICK-GRIP Handi Clamp

- Resin
- 4" size
- 4" capacity
- 4" jaw width

Item #	price
G3156307	<b>\$7.03</b>



## DE-STA-CO Latch Clamp

- 375 lb holding capacity
- 8.82" x 1.83"
- .22" diameter
- J hook arm
- Ergonomic grip

Item #	price
G3436151	<b>\$10.43</b>



## BESSEY Sliding Arm Bar Clamp

- Steel bar
- Steel handle
- 8" opening
- 2 1/4" throat depth
- 400 lb load capacity

Item #	price
G3020622	<b>\$15.66</b>



## WILTON C-Clamp

- Black oxide finish
- Cast Iron
- Light duty
- Powder coat finish
- 0" min opening

Item #	max opening	throat depth	clamping pressure	price
G4411696	6"	2 3/4"	2450	<b>\$30.32</b>
G4411705	8"	3 3/4"	2750	<b>\$32.42</b>



## WESTWARD C-Clamp

- Copper plated spindle finish
- Drop forged steel
- Regular duty
- V-groove anvil shape
- Swivel pad

Item #	size	price
G3421957	4"	<b>\$43.87</b>
G0492423	6"	<b>\$62.83</b>
G0944702	8"	<b>\$79.47</b>

**LEATHERMAN Multi-Tool**

- Stainless steel
- Butterfly opening
- (14) tools
- 14 functions
- 6¼" open length

**#** price  
G4411942 **\$27.21**



**STANLEY Retractable Utility Knife**

- High carbon steel
- Plastic handle
- 6" overall length
- 3" overall width
- 7/8" thick

*includes (1) blade*  
**#** price  
G0908862 **\$2.19**



**STANLEY Utility Knife**

- High carbon steel blade
- Die cast metal handle
- 6" overall length
- 3" overall width
- 3/4" thick

*includes (3) heavy duty blades*  
**#** price  
G2851992 **\$3.29**

**VICTORINOX SWISS ARMY Multi-Tool**

- Stainless steel
- Butterfly opening
- (12) tools
- 27 functions
- 6¾" open length

**#** price  
G1519113 **\$89.99**

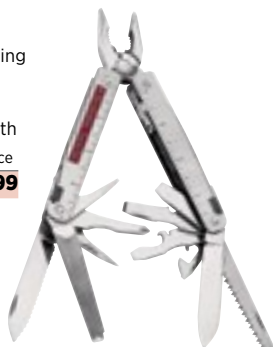

**STANLEY Retractable Utility Knife with String Cutter**

- High carbon steel
- Metal handle
- 6¾" overall length
- 3" overall width
- 7/8" thick

*includes (3) blades*  
**#** price  
G1504745 **\$5.26**



**STANLEY Utility Knife**

- Steel blade
- Metal with rubber grip handle
- 6¾" overall length
- 1¾" overall width
- 7/8" thick

*includes (5) blades*  
**#** price  
G2137712 **\$8.88**



**SOG Kilowatt Knife**

- AUS-8 stainless steel with satin finish
- Glass reinforced zytel handle
- Folding blade
- Straight edge
- 3½" blade length

**#** price  
G3161505 **\$36.36**



**STANLEY #9 Single Edge Utility Blades**

- High carbon steel
- 2" x 1½"
- 0.009" thick
- 100 pack

**#** price  
G0423622 **\$5.20**



**STANLEY 2-Point Heavy Duty Utility Blades**

- High carbon steel
- 2 holding notches
- ¾" x 2¼"
- .024" thick
- 100 pack

**#** price  
G0984733 **\$10.92**

**HYDE Plastic Putty Knife**

- Polypropylene handle
- Polypropylene blade
- 7¼" overall length
- 1½" blade width
- 3½" handle length

**#** price  
G3309905 **\$0.38**



**DEWALT Fixed Blade Utility Knife**

- Steel blade
- Steel/rubber handle
- 8" overall length
- 3" overall width
- 1" thick
- 2 prong blade

*includes (3) blades*  
**#** price  
G7636167 **\$8.34**

**VICTORINOX SWISS ARMY Multi-Tool Folding Knife**

- Stainless steel implements with plastic handle
- (9) tools
- 16 functions
- 2¼" closed length

**#** price  
G2868162 **\$36.01**





# TOOLS

MORE THAN 800,000 ITEMS ONLINE

**CLC Tool Tote With Parts Tray**

- Polyester
- 23 pockets
- 11" w x 10" d x 19" h

*includes 11" x 6" multi-compartment plastic bottom tray*



**#** price  
G1409274 **\$33.98**

**CLC Electricians Tool Pouch**

- Polyester
- 21 pockets
- 5" x 8"
- Fits belts up to 2 3/4"
- Standard tool tether capable

*features shoulder strap and zipper pocket*



**#** price  
G0753277 **\$25.02**



**CLC Tool Bag**

- Polyester
- 52 pockets
- 18" w x 7" d x 14" h

*includes carabiner and features anti skid pads, heavy duty zippers and hardware and padded shoulder strap*



**#** price  
G1273955 **\$49.97**

**CLC Tote Bag**

- Polyester
- 22 pockets
- 16" w x 8" d x 10" h



**#** price  
G1779802 **\$22.04**

**WESTWARD Wide Mouth Tool Bag**

- 600 denier polyester
- 23 pockets
- 13" w x 9 3/4" d x 9" h

*includes adjustable shoulder strap and features top opening reinforced with metal*

**#** price  
G2776182 **\$18.01**



**ERGODYNE Wrench Roll-Up Bag**

- Canvas
- 14 pockets
- Standard tool tether capable

**#** price  
G3951394 **\$17.78**

**CLC Web Work Belt**

- Polyester web
- 29" to 46"
- Quick release buckle



**#** price  
G3257667 **\$4.40**

**CLC Tool Bag**

- Polyester
- 32 pockets
- 24" w x 11" d x 12" h

*includes padded handles and adjustable shoulder strap*



**#** price  
G2560695 **\$35.27**

**CLC Socket/Tool Roll Pouch**

- Polyester
- Standard tool tether capable
- Accommodates metric/standard sockets, elastic strap and carrying handle



**#** price  
G2293523 **\$13.21**

**CLC Drawstring Tool Bag**

- Polyester
- 22 Pockets
- 7" height

*features lock/pushbutton release drawstring system, soft bottom panel and carrying handle*



**#** price  
G2981133 **\$9.45**

**CLC Bucket Organizer**

- Polyester
- 12" height
- 11 1/2" diameter
- 61 compartments
- For use with standard 3 1/2 to 5 gal buckets (bucket not included)



**#** price  
G2544114 **\$18.93**

**KLEIN TOOLS Tool Pouch**

- Canvas
- Bull-pin and bolt bag
- Standard tool tether capable

*features double bottom, bolt bag with bull-pin loop on each side*



**#** price  
G3672742 **\$15.14**

**CLC Tool Backpack**

- Nylon and leather
- 48 pockets
- 14" w x 11" d x 16" h

*includes reinforced carrying handle*

**#** price  
G2376963 **\$53.78**







**JOBBOX  
Jobsite Piano Box**

- Steel
- 47.5 cu-ft storage capacity
- 60" w x 31<sup>1</sup>/<sub>2</sub>" d x 49<sup>1</sup>/<sub>2</sub>" h
- 16 gauge

*includes padlock enclosure and features gas springs guards, forklift access, 500 lb capacity lower shelf which tilts up to provide nearly 12 additional storage height*

#	price
G0591123	<b>\$1,079.99</b>



**JOBBOX  
Jobsite Welders Box**

- Steel
- 3.3 cu-ft storage capacity
- 30" w x 16" d x 12" h
- 16 gauge

*features power supply knock-out hole, padlock hasp to secure torch and cutout for connected torch hoses*

#	price
G0992993	<b>\$129.99</b>



**CONTICO  
Rolling Tool Box**

- Plastic
- 32" w x 17" d x 12<sup>1</sup>/<sub>4</sub>" h overall dimensions
- 27<sup>1</sup>/<sub>2</sub>" w x 12<sup>3</sup>/<sub>4</sub>" d x 11<sup>3</sup>/<sub>4</sub>" h inside dimensions
- 23.5 gal storage capacity
- Matte Finish

#	price
G2946081	<b>\$31.41</b>

**STANLEY Mobile Work Station**

- 14" w x 22" l x 29" h
- 88 lb hold capacity
- Black finish

#	price
G2402574	<b>\$77.40</b>



**CONTICO  
Portable Tool Box**

- High density structural foam
- 37" w x 21" d x 20" h
- 12,274 cu-in storage capacity
- 250 lb load rating

*includes lock and keys*

#	price
G0816715	<b>\$59.75</b>



**GREENLEE  
Jobsite Chest**

- Steel
- 48" w x 30" d x 30" h
- 25 cu-ft storage capacity
- Hinged with locking arm lid
- 16 gauge

#	price
G4021893	<b>\$509.85</b>

**STANLEY  
Portable  
Tool Box**

- Metal and Resin
  - 26" w x 12" d x 12" h
  - Resin handle
  - Matte finish
- includes removable vertical storage unit inside*

#	price
G3142605	<b>\$40.52</b>



**STANLEY  
Rolling Tool Box**

- High density structural foam
- 22<sup>3</sup>/<sub>16</sub>" w x 37<sup>1</sup>/<sub>2</sub>" d x 23<sup>1</sup>/<sub>4</sub>" h
- 50 gal storage capacity

*features deep tote, includes tote tray and (2) deep compartments*

#	price
G2464271	<b>\$67.90</b>

**KENNEDY  
Cantilever Tool Box**

- Steel
  - Steel core, vinyl cushioned handle design
  - 22<sup>1</sup>/<sub>8</sub>" w x 10<sup>1</sup>/<sub>8</sub>" d x 12<sup>5</sup>/<sub>8</sub>" h
  - 4 trays
  - Textured finish
- features movable/removable partitions and divider sets on (2) trays*

#	price
G2817744	<b>\$142.80</b>





# TOOLS

MORE THAN 800,000 ITEMS ONLINE

### STANLEY PowerLock Measuring Tape

- Steel blade
- Yellow blade
- Riveted, corrosion resistant with True-Zero hook

Item #	size	case material	price
G0820163	¼" x 10'	chrome/abs plastic	<b>\$3.19</b>
G0469971	½" x 12'	die-cast metal	<b>\$8.99</b>
G2573356	¾" x 16'	high impact chrome/abs plastic	<b>\$9.05</b>



### STANLEY Tape Measure

- Steel blade
- ABS plastic case
- 1" x 25'
- Automatic rewind
- 1/16" graduations
- Stud markings



Item #	price
G0366676	<b>\$11.63</b>



### JOHNSON Rare Earth Magnetic Torpedo Level

- Aluminum frame
- Acrylic vials
- Rare earth magnet
- 9" length
- (3) vials

Item #	price
G1721291	<b>\$9.83</b>

### PROTO Telescopic Magnetic Retrieving Tool

- 16¾" length
- ½" diameter
- 26¾" extended length
- 2 lb pull capacity
- features all-angle ball joints



Item #	price
G3378216	<b>\$10.78</b>



### LUFKIN Long Tape Measure

- Steel blade
- ABS plastic case
- ¾" x 100'
- 1/8" graduations
- Manual rewind

Item #	price
G2897422	<b>\$14.98</b>



### JOHNSON Combination Squares

- Steel blade
- Zinc head
- (2) pieces

Item #	length	price
G0336567	6"	<b>\$6.45</b>
G2274666	12"	<b>\$7.19</b>
G0884152	16"	<b>\$11.99</b>

### JOHNSON Magnetic Stud Finder

- 1½" x 3¼"
- features level vial, high impact plastic body and acrylic cover



Item #	price
G1111223	<b>\$3.05</b>



### WESTWARD Telescoping Inspection Mirror

- Glass
- Metal handle
- Copper shaft
- Magnet tip
- 1¼" mirror size
- Double ball joint swivel

Item #	price
G1661466	<b>\$4.12</b>

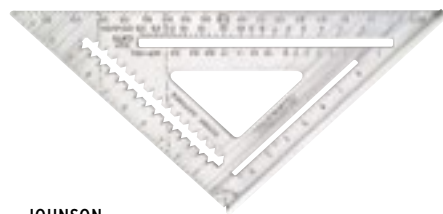

### JOHNSON Rafter Angle Square

- Milled aluminum
- Low glare powder coat
- 12" size
- includes instruction manual

Item #	price
G2293033	<b>\$12.16</b>



### WESTWARD Machinist Scriber

- Steel handle
- Hardened steel tip
- 9" overall length
- 3/16" handle diameter
- includes (3) points

Item #	price
G1174686	<b>\$5.82</b>

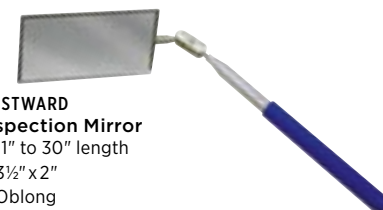

### WESTWARD Inspection Mirror

- 11" to 30" length
- 3½" x 2"
- Oblong

Item #	price
G0682945	<b>\$15.49</b>

**MILWAUKEE  
Orbital Jig Saw**

- 120 V, 6.5 A
- 0 to 3000 strokes per minute
- 9½" tool length
- includes (2) blades and dust shield*



# price  
G4936924 **\$191.33**

**MILWAUKEE Sawzall Reciprocating Saw**

- 120 V, 12 A
- 1½" blade stroke
- 19" tool length

# price  
G4935217 **\$128.27**



**MILWAUKEE Cordless Reciprocating Saw Kit**

- 18 V, 1.5 A/hr
- ¾" stroke length
- Li-Ion battery
- 13" tool length

# price  
G4901172 **\$203.67**



**DEWALT Table Saw**

- 120 V, 15 A AC
- 26½" w x 26¾" d x 12¾" h
- 10" blade diameter
- 4800 no load rpm

# price  
G7639861 **\$805.44**



**DEWALT Spiral Saw**

- 5 A @ 120 V
- 30,000 no load rpm
- 10" tool length
- 10' cord length
- includes drywall cutting bit and ¼", ⅜" collets*

# price  
G1821233 **\$64.92**



**QEP Portable Contractor Tile Saw**

- 120 V, 3.8 A
- Wet cutting
- 7" blade diameter
- Steel table with tilt control
- includes diamond blade, rip guide, angle guide and (2) wrenches*

# price  
G1013074 **\$60.03**



**QEP Tile Saw**

- 120 V, 9.5 A
- 21½" w x 40" l x 48½" h
- 10" blade diameter, 2⅜" cut depth
- Fiberglass water tray

# price  
G4931333 **\$396.50**



**QEP Dual Tile Saw**

- 120 V, 15 A
- 22" w x 40" l x 47" h
- 10" blade diameter
- ⅝" arbor hole
- Rugged steel support, fiberglass water tray

# price  
G4931342 **\$314.68**



**MAKITA  
Chop Saw**

- 120 V, 15 A
- 12" blade diameter
- 45° pivoting fence angle
- Cast aluminum
- includes carbide tipped blade*

# price  
G2287941 **\$516.96**



**DEWALT  
Chop Saw**

- 120 V, 15 A
- 14" blade diameter
- 4000 no load rpm
- Steel
- includes abrasive wheel*

# price  
G3410933 **\$223.12**



**MILWAUKEE Cordless Band Saw**

- 12 V
- 27" blade length
- 1½" x 1½" rectangle capacity
- 12" tool length
- Bare tool (no battery)
- includes 18 TPI Sub-Compact band saw blade (G4922477)*

# price  
G4931455 **\$151.41**



**DEWALT Cordless Circular Saw**

- 18 V
- 6½" blade diameter
- NiCd battery
- 3700 no load rpm
- Bare tool (no battery)
- includes carbide tipped blade and blade wrench*

# price  
G1189002 **\$108.10**

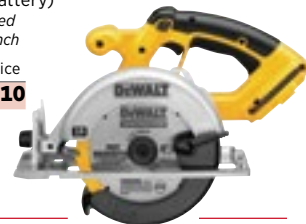

**MAKITA Circular Saw**

- 115 V, 15 A
- 7¼" blade diameter
- 5800 no load rpm
- Aluminum shoe
- includes 24t carbide tipped blade and blade wrench*

# price  
G3631135 **\$134.75**





# TOOLS

MORE THAN 800,000 ITEMS ONLINE

### PORTER CABLE Cordless Drill/Driver Kit

- 18V
  - 1/2" chuck size
  - 0 to 850/0 to 1500 no load rpm
  - NiCd battery
- includes (2) batteries, charger, storage bag and double-ended bit tip*

**#** price  
G4988575 **\$134.97**



### DEWALT Cordless Hammer Drill

- 18V, 0 to 500/0 to 1250/0 to 2000 no load rpm
- 1/2" chuck size
- NiCd battery
- Bare tool (no battery)

**#** price  
G1900972 **\$142.79**



### MILWAUKEE Cordless Drill/Driver Kit

- 12V, 0 to 450/0 to 1700 no load rpm
  - 1/2" chuck size
  - Li-Ion battery
  - 2.0 A/hr/4.0 A/hr battery capacity
- includes 2.0 battery pack, 4.0 battery pack, charger, belt clip and carrying case*

**#** price  
G4989056 **\$204.71**



### DEWALT Cordless Drill/Driver

- 20V, 0 to 600/0 to 2000 no load rpm
  - 2 speed transmission
  - Li-Ion battery
  - Bare tool (no battery)
- includes belt hook and on board bit holder*

**#** price  
G7418126 **\$129.36**



### MAKITA Electric Drill

- 120V, 4.9A
- 3/8" chuck size
- 0 to 2500 no load rpm
- 10 3/16" tool length

**#** price  
G4920745 **\$88.10**



### MILWAUKEE Cordless Impact Driver Kit

- 12V, 0 to 1200/0 to 2650 no load rpm
  - 1/4" hex drive size
  - Li-Ion battery
- includes (2) battery packs, battery charger and carrying case*

**#** price  
G4988952 **\$187.87**



### DEWALT Electric Drill

- 120V, 10 A
- 1/2" chuck size
- 0 to 1250 no load rpm
- 360° side handle with soft grip

**#** price  
G0318561 **\$157.39**



### SKIL Hammer Drill

- 120V, 7 A
  - 1/2" chuck size
  - 3000 no load rpm
  - 13.75" tool length, 6.77 lb tool weight
- includes chuck key and side assist handle*

**#** price  
G4927797 **\$71.37**



### PANASONIC Cordless Impact Driver Kit

- 18.0V or 14.4V
  - 1/4" drive size
  - 0 to 2500 no load rpm
  - 1370 in lb max torque
- includes 2 battery packs, charger and case*

**#** price  
G7565966 **\$427.56**



### JET Bench Drill Press

- 115V, 11A AC
- 15" swing
- 5/8" chuck size
- 1/2" capacity steel
- 3/8" capacity cast iron

**#** price  
G0476795 **\$529.00**



### DAYTON Floor Drill Press

- 120V/240V
- 8.6A/4.3A AC
- 5/8" chuck size
- 12 3/4" x 19 3/4" base size

**#** price  
G1470594 **\$587.23**



### MILWAUKEE Cordless Drill/Driver

- 12V
- 0 to 450/0 to 1700 no load rpm
- 1/2" chuck size
- Li-Ion battery
- 2.0 A/hr/4.0 A/hr battery capacity
- Bare tool (no battery)

**#** price  
G4988934 **\$139.93**



**DEWALT**

**18 V Cordless Screwdriver Kit**

- 18 V, 0 to 900/0 to 2900 no load rpm
- 1/4" chuck size
- NiCd battery

*includes 1 hr 120 V charger, (2) batteries, bit tip magnetic holder, drywall nosepiece, teks nosepiece, kit box and carrying case*

**# price**  
G0818456 **\$280.74**



**INGERSOLL-RAND**

**Cordless Impact Wrench Kit**

- 20 V, 0 to 1900 no load rpm
- 1/2" drive size
- Li-Ion battery

*includes (2) 20 V Li-Ion batteries, battery charger, auxiliary usb port and carrying case*

**# price**  
G4931866 **\$500.96**



**MILWAUKEE Cordless Screwdriver Kit**

- 4.0 V
- 1/4" hex quick change chuck size
- Li-Ion battery
- 9 3/4" tool length

*includes battery and charger*

**# price**  
G4934194 **\$112.72**



**MILWAUKEE**

**Cordless Screwdriver**

- 12 V, 0 to 400/0 to 1500 no load rpm
- 1/4" hex quick change chuck size
- Li-Ion battery capacity
- Bare tool (no battery)

**# price**  
G7618572 **\$89.40**



**DEWALT**

**Impact Wrench**

- 120 VAC, 7.5 A
- 0 to 2100 no load rpm
- 1/2" drive size
- 11 1/4" tool length

**# price**  
G1187934 **\$203.70**



**BOSCH**

**Cordless Screwdriver Kit**

- 12 V, 0 to 600 no load rpm
- 1/4" chuck size
- Li-Ion battery
- 10" tool length

*includes (2) batteries, charger and case*

**# price**  
G2768227 **\$158.30**



**DEWALT**

**Cordless Screwdriver**

- 20 V, 0 to 2000 no load rpm
- 1/2" chuck size
- Li-Ion battery
- 7" tool length
- Bare tool (no battery)

**# price**  
G7419063 **\$129.36**



**MAKITA**

**Impact Wrench**

- 120 VAC, 9 A
- 0 to 1700 no load rpm
- 3/4" drive size
- 12 7/8" tool length

**# price**  
G4920885 **\$574.64**



**DEWALT**

**Cordless Impact Wrench Kit**

- 18 V, 0 to 1650 no load rpm
- 2.4 A/hr battery capacity
- 1/2" drive size

*includes 1 hr charger, (2) 18 V XRP batteries and box*

**# price**  
G1575761 **\$379.64**



**MILWAUKEE**

**Metal Fastening Screwdriver**

- 120 V, 6.5 A
- 0 to 2500 no load rpm
- 140 in-lbs max torque
- Adjustable clutch

*includes bit holder*  
**# price**  
G4886935 **\$178.50**



**MILWAUKEE**

**Cordless Impact Wrench Kit**

- 12 V, 0 to 1200/0 to 2650 no load rpm
- 3/8" drive size
- Li-Ion battery

*includes (2) batteries, charger and carrying case*

**# price**  
G4989153 **\$221.55**



**DEWALT Versa Clutch Screwdriver**

- 0 to 2500 no load rpm
- 132 in-lbs max torque
- 1/4" hex shank size
- 11.5" tool length

**# price**  
G0547967 **\$207.19**





# TOOLS

MORE THAN 800,000 ITEMS ONLINE

### DAYTON Belt/Disc Sander

- 120V
- 1/2 HP
- 3.5 A AC
- 6" disc diameter
- 13" w x 14 1/2" d x 23" h

**Z#** price  
**G2309045 \$201.28**



### DAYTON Combination Belt and Bench Grinder

- 115V/230V, 3/4 HP
- 7.0/3.5 A AC
- 8" wheel diameter
- 20" w x 14" d x 25 1/2" h

**Z#** price  
**G2181995 \$443.64**



### DEWALT Palm Sander

- 2.4 A @ 120V
  - 14,000 no load rpm
  - 4 1/8" x 4 1/2" pad size
  - 6" tool length
- includes (1) sanding sheet and tool bag*

**Z#** price  
**G0916684 \$56.39**



### BOSCH Random Orbit Electric Sander Kit

- 2.5 A @ 120V
- 7,500-12,000 no load rpm
- 5" pad size
- 9" tool length

*includes sanding disc, carrying case, dampening ring and soft sanding pad*

**Z#** price  
**G4927842 \$90.98**



### MILWAUKEE Cordless Cutoff/Grinder

- 18V, 9000 no load rpm
  - 4 1/2" size
  - 13 1/4" tool length
- includes type 1 guard, type 27 guard, spanner wrench, side handle and tool free guard*

**Z#** price  
**G2658643 \$129.99**



### HARDIN Pipe Surface Polisher

- 1 1/2" x 30" belt size
  - 8 A @ 120V
  - 10 lb tool weight
  - 21 1/2" tool length
- includes coarse belt*

**Z#** price  
**G7525454 \$328.75**



### MAKITA Cordless Random Orbit Sander

- 18V
- 3.0 A/hr battery capacity
- Li-Ion battery
- 5" disc size, 6 7/8" tool length

**Z#** price  
**G5016286 \$124.12**



### METABO Die Grinder

- 120V, 6.4 A @ 120V
- 13,000 to 34,000 no load rpm
- 1/4" collet capacity
- 10" tool length

**Z#** price  
**G4988882 \$248.80**



### HITACHI Sander Polisher

- 11 A @ 120V
- 0 to 3400 no load rpm
- 7" size
- 5/8"-11" spindle thread size
- 10 1/2" tool length

**Z#** price  
**G7533522 \$217.07**



### DEWALT Angle Grinder

- 120V
  - 12 A
  - 10,000 no load rpm
  - 5" wheel diameter
- includes type 27 wheel, wrench, guard, backing flange and clamp nut for 3/8" non-threaded wheels*

**Z#** price  
**G2287223 \$145.70**



### MILWAUKEE Right Angle Polisher

- 11.0 A @ 120V
  - 0 to 750 no load rpm
  - 7" and 9" size
  - 16.5" tool length
- includes 7" rubber backing pad, disc nut and side handle*

**Z#** price  
**G0295635 \$223.89**



### HARDIN Wet Polisher

- 8 A @ 120V
- 1000 to 4500 no load rpm
- 5" size
- 15" tool length
- 7.5 lb tool weight

**Z#** price  
**G7496517 \$299.66**



**MAKITA  
Planer Kit**

- 6.5A @ 120V, 17,000 no load rpm
- 3/32" cutting depth
- 3 1/4" cutting width
- 11 1/4" tool length

# price  
G4316006 **\$176.02**



**MAKITA  
Cordless Planer**

- 18V, 14,000 no load rpm
- 3/4" cutting width
- 0 to 3/4" cutting depth
- Tool only (no battery)

# price  
G7535001 **\$218.96**



**PORTER CABLE Plate Jointer Kit**

- 7.5A @ 120V
  - 0 to 135 tilting angle degree
  - 10,000 no load rpm
  - 14" overall length
- includes dust bag, deflector, vacuum adapter, wrench and carrying case

# price  
G2249861 **\$259.72**



**MILWAUKEE  
Cordless Oscillating Tool Kit**

- 12V
  - 5,000 to 20,000 orbits per minute
  - 10 1/4" tool length
  - 1.6 lb tool weight
- includes wood cutting blade, sanding pad and (5) sandpaper sheets

# price  
G4912372 **\$83.47**



**BOSCH  
Cordless Shear Kit**

- 12V
  - 2.0A/hr battery capacity
  - Li-Ion battery
  - 10" tool length
- includes 30 min charger, feeler gauge, (2) batteries, allen key, carrying case and mounted blade set

# price  
G0466304 **\$364.46**



**MILWAUKEE  
Cordless Shear**

- 12V
- 2 3/8" OD cutting capacity
- 5 no load rpm
- For copper, plastic, rubber, vinyl tubing and hose
- 14 1/2" tool length

# price  
G4909231 **\$144.01**



**DEWALT  
Oscillating Tool Kit**

- 20V
  - 21,000 orbits per minute
  - Li-Ion battery
  - 2.0A/hr battery capacity
- includes Li-Ion battery 2.0A/hr, fast charger, DeWALT oscillating tool guide system, bi-metal plunge cut blade, fast-cut wood blade, sanding pad, (25) sheets of sanding paper, universal accessory adaptor, contractor bag and accessory storage box

# price  
G7418406 **\$221.53**



**MAKITA  
Cordless Oscillating Tool Kit**

- 18V
  - 20,000 orbits per minute
  - 3.0A/hr battery capacity
  - 12" tool length
- includes (2) batteries, 30 minute rapid charger, blade, sanding pad, (10) sandpaper sheets and carrying case

# price  
G4934316 **\$355.43**



**JET  
Planer Jointer Combo**

- 13A @ 120V
- 9000 rpm
- 16 1/2" w x 31" d x 18 1/2" h
- 8" cutting width

# price  
G7504497 **\$399.65**





# TOOLS

MORE THAN 800,000 ITEMS ONLINE

### MILWAUKEE Reciprocating Saw Blades

- Bi-metal
- 1/2" universal shank
- ► [MORE SIZES ONLINE](#)

6" Length			
Item #	TPI	packs	price
G1600453	14	5	<b>\$7.82</b>
G1071612	14	50	<b>\$71.26</b>
G0850166	18	5	<b>\$8.89</b>
G1756605	18	50	<b>\$59.99</b>
G2985175	24	5	<b>\$8.60</b>
G0723886	24	50	<b>\$58.74</b>

9" Length			
Item #	TPI	packs	price
G0323215	18	5	<b>\$8.95</b>
G3374323	18	50	<b>\$108.09</b>



### WESTWARD Jigsaw Blades

- HCS-65Mn
- T shank
- 6 teeth per inch
- 5 pack

Item #	length	price
G4981873	4"	<b>\$6.35</b>
G4982092	6"	<b>\$13.94</b>



### MORSE Band Saw Blades

- Matrix II grade
- Bi-metal
- 0.035" thickness
- For aluminum castings, carbon steel, and structural steel

Item #	TPI	tooth type	price
G2756171	10/14	variable	<b>\$35.04</b>
G3035094	14	raker	<b>\$49.98</b>



### HUSQVARNA Diamond Saw Blades

- Wet/dry cutting
- Segmented rim
- 1" arbor hole
- Standard grade
- 0.130" plate thickness

Item #	blade		price
	dia	cutting depth	
G0485983	12"	3 3/8"	<b>\$71.29</b>
G1554332	14"	4 1/4"	<b>\$75.39</b>



### DIAMOND VANTAGE Wet/Dry Diamond Saw Blades

- Wet/dry cutting
- Segmented rim
- 1", 20 mm arbor hole
- 0.130" plate thickness
- For use with high speed saws, masonry saws, 5 to 20 HP walk behind concrete saws



Item #	dia	cutting depth	price
G4921971	12"	4"	<b>\$31.72</b>
G4922023	14"	5"	<b>\$38.65</b>



### QEP Tile Saw Blades

- Wet/dry cutting
- Continuous rim
- For ceramic, porcelain, and marble

Item #	dia	cutting depth	rpm (max)	price
G4934036	7"	2"	8,730	<b>\$21.16</b>
G4934054	10"	3 3/4"	6,115	<b>\$33.45</b>

### MILWAUKEE Metal Cutting Circular Saw Blades

- Carbide tip
- Metal cutting blade
- ATB tooth grind
- For cutting ferrous materials including pipe, angle iron, metal studs and conduit



Item #	dia	teeth	price
G4886585	6 1/2"	48	<b>\$46.99</b>
G4886892	14"	72	<b>\$192.07</b>

### MORSE Circular Saw Blades

- Carbide tip
- Metal cutting blade
- 10° hook angle
- ATB tooth grind



Item #	dia	arbor hole	cutting depth	price
G1624183	8"	5/8"	2 1/16"	<b>\$49.09</b>
G0833603	9"	1"	3 1/2"	<b>\$52.10</b>

### MILWAUKEE Portable Band Saw Blades

- 1/2" width
- For strut, conduit, angle iron, copper tube, threaded rod and pipe
- 3 pack

Item #	material	grade	length	thickness	TPI	tooth type	price
G4886542	carbon steel	matrix II	3'8 3/4"	0.020"	10/14	raker	<b>\$14.72</b>
G4922477	bimetal	sub to compact	2'3"	0.032"	18	steel	<b>\$28.66</b>



### MORSE Air Saw Blade

- For thin sheet metal, automotive, muffler shops, metal fabricating
- 1/2" x 4"
- 24 teeth per inch
- Bi-metal
- 1/2" universal shank
- 5 pack

Item #	price
G0799732	<b>\$7.75</b>





**VORTEC Flap Brushes**

- 4" brush diameter
- Abrasive nylon
- 3500 max rpm
- 1/4" shank size

Q #	grit	price
G3371627	x-coarse	<b>\$9.25</b>
G2143811	coarse	<b>\$9.25</b>
G1073852	medium/fine	<b>\$7.55</b>

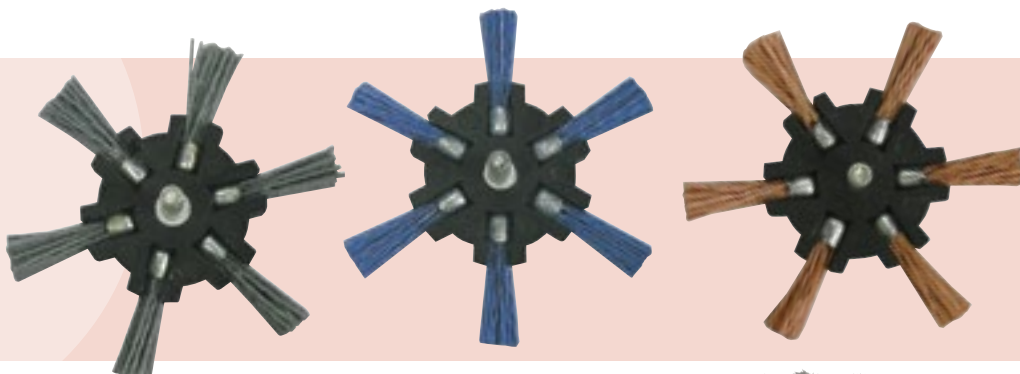

**WESTWARD**

**Crimped Wire Wheel Brushes**

- Crimped wire bristle
- Stem mounting

Q #	brush dia	face width	wire dia	price
G0317116	2"	3/8"	.0118"	<b>\$10.09</b>
G1595833	3"	1/2"	.014"	<b>\$21.54</b>



**WESTWARD**

**Twist Wire Wheel Brush**

- Twist wire bristle
- Threaded arbor
- 4" diameter
- Carbon steel fill
- 1/2" face width
- For use with low speed/high torque portable tools

Q #	price
G1422084	<b>\$19.74</b>



**WEILER Knot Wire Wheel Brush**

- Knot wire bristle
- Threaded arbor
- 4" diameter
- Carbon steel fill
- For use with right angle grinders, straight grinders, bench or pedestal grinders

Q #	price
G4134471	<b>\$14.13</b>



**DREMEL**

**Flap Wheels**

- 80 grit

Q #	dia	price
G0474372	3/16"	
G2564457	3/8"	

each **\$5.91**



**WESTWARD Stringer Twist Wheels**

- Threaded arbor
- For use with low speed/high torque portable tools
- 4" diameter
- 1/2" face width

Q #	bristle	fill material	price
G2593087	stringer bead twist wire	carbon steel	<b>\$17.24</b>
G1082934	twist wire	stainless steel	<b>\$29.30</b>



**DEWALT**

**Grinding Wheel**

- 4" diameter

Q #	price
G7636964	<b>\$41.86</b>



**NORTON PSA Sanding Discs**

- Closed coat, resin bonded
- Aluminum oxide
- Cloth backing
- R228 series

**5" Diameter**

Q #	grit	price
G2583411	40	<b>\$1.08</b>
G2416154	100	<b>\$1.28</b>

**8" Diameter**

Q #	grit	price
G2283303	50	<b>\$2.76</b>
G2433654	60	<b>\$4.04</b>



**ARC ABRASIVES PSA Sanding Discs**

- Closed coat
- Aluminum oxide
- Cloth backing
- 12" diameter

Q #	grit	price
G0499511	60	<b>\$5.73</b>
G1514143	80	<b>\$6.10</b>
G0821335	100	<b>\$7.34</b>





# TOOLS

## MILWAUKEE Battery Charger

- 120 VAC
- NiCd battery
- 3.0A/hr
- 1 port
- For use with 12V, 14.4V, 18V Power Plus batteries, nickel cadmium, nickel metal hydride

Z#	price
G2960316	<b>\$51.89</b>



## MILWAUKEE NiCd Battery Packs

- NiCd battery
- 2.4A/hr
- 12V: for use with all 12V Power Plus Lok Tor tools
- 14.4V and 18V: for use with Power Plus tools and accessories

Z#	voltage	price
G1993275	12V	<b>\$65.17</b>
G2837387	14.4V	<b>\$67.75</b>
G2120097	18V	<b>\$81.95</b>



## PORTER CABLE Battery Charger

- 120VAC
- Li-Ion battery
- 1 port
- 40 min charge time
- For use with all Porter Cable 20V tools

Z#	price
G5174321	<b>\$41.81</b>



## PORTER CABLE Battery Packs

- 20V
- Li-Ion battery
- 1.5A/hr: for use with all Porter Cable 20V power tools
- 4.0A/hr: for use with all Porter Cable 20V max power tools with no memory and minimal self discharge

Z#	capacity	price
G7462935	1.5A/hr	<b>\$78.46</b>
G7548956	4.0A/hr	<b>\$94.16</b>



## MILWAUKEE Battery Charger

- 120VAC
- 3.0A/hr
- 1 port
- For use with all Milwaukee 2.4V power tools

Z#	price
G0440237	<b>\$46.72</b>



## MILWAUKEE Battery Pack

- 2.4V
- 1.3A/hr
- For use with Milwaukee 2.4V tools

Z#	price
G1893674	<b>\$21.79</b>



## MILWAUKEE Battery Charger

- 120VAC/12VDC
- Li-Ion battery
- 3.0A/hr
- 1 port
- Vehicle compatible

Z#	price
G1850125	<b>\$96.53</b>



## MILWAUKEE Battery Packs

- 18V
- Li-Ion battery
- 1.5A/hr: for use with Milwaukee 18V tools and accessories
- 3.0A/hr: for use with 18VDC Li-Ion and NiCd tools and accessories

Z#	capacity	price
G1190016	1.5A/hr	<b>\$90.90</b>
G0360491	3.0A/hr	<b>\$110.13</b>



## MILWAUKEE Battery Charger

- 120VAC
- Li-Ion battery
- 3.0A/hr
- For use with Milwaukee M12 batteries

Z#	price
G1756711	<b>\$47.94</b>



## MILWAUKEE Battery Pack

- 12V
- Li-Ion battery
- 1.5A/hr
- For use with Milwaukee M12V tools includes M12 red lithium battery

Z#	price
G3394151	<b>\$41.46</b>



## MAKITA Battery Charger

- 120VAC
- Li-Ion battery
- 3.3A/hr
- 1 port
- For use with Makita 18.0V Li-Ion and LXT batteries

Z#	price
G0514613	<b>\$91.99</b>



## MAKITA Battery Pack

- 18V
- Li-Ion battery
- 3.0A/hr
- For use with Makita 18.0V Li-Ion and LXT tools

Z#	price
G1826352	<b>\$103.24</b>



## DEWALT Battery Charger

- 120VAC
- Li-Ion battery
- 3.0A/hr
- 1 port
- 60 min to charge, 3-stage charging system

Z#	price
G0862793	<b>\$100.98</b>



## DEWALT Battery Pack

- 36V
- Li-Ion battery
- 2.0A/hr
- For use with all DeWALT 36V tools

Z#	price
G7640376	<b>\$191.50</b>



**DEWALT Worksite Charger Radio**

- 12.0V
- For use with all 12V and 20V DeWALT batteries
- Li-Ion battery
- 3.0A/hr
- Battery not included

# price  
G7421531 **\$201.67**



**MILWAUKEE Jobsite Radio**

- Will charge NiCd batteries
- For use with 12.0V to 18.0V NiCd slide on packs
- CD player port
- 6' cord
- Weather resistant
- Digital tuner
- High performance speakers
- AC/DC versatility
- Sealed battery and mp3 player compartment

# price  
G2403947 **\$128.01**



**MAKITA Jobsite Radio with Ipod Dock**

- 18.0V
- For use with any Makita Li-Ion or NiCd battery
- Battery pack replacement G1826352 and G1608765

# price  
G7577062 **\$154.18**



**SPEEDAIRE Tool Balancer**

- For 4 to 6 lb tool
- Die cast aluminum housing
- 5' cable length
- Steel cable
- 3 suspension points

# price  
G1546413 **\$97.86**



**PORTER CABLE 120° to 1150° F Heat Gun**

- 120V
- 1500W
- General purpose

# price  
G4932907 **\$32.83**



**MASTER APPLIANCE 750° to 1000° F Heat Gun**

- 120V
- 1740W
- General purpose

# price  
G1994054 **\$91.14**



**HUBBELL Tool Retractors**

- BD series
- 6' cable length
- Steel housing
- Galvanized steel cable
- Adjustable cable stop and lower safety hook

#	for tool weighing	price
G1757935	0.5 to 1.5 lb	<b>\$44.09</b>
G0251011	1.5 to 3.0 lb	<b>\$40.41</b>



**MILWAUKEE Power Source**

- 18.0V
- Charges portable electronic devices
- USB port

# price  
G4933047 **\$29.00**



**DAYTON Electric Engraver**

- 3600 and 7200 strokes per minute
- Engraves most surfaces
- 7 1/4" tool length
- 0.4 lb tool weight

# price  
G4017422 **\$42.29**



**DAYTON Battery Operated Engraver**

- 3300 strokes per minute
- Engraves most surfaces
- 6" tool length
- 0.3 lb tool weight

# price  
G4153073 **\$16.92**



**TOOLS**



**MILWAUKEE Self Feed Drill Bit**

- Heat treated steel alloy
- For use with handheld drills and drill presses
- 7/16" hex size

Item #	dia	overall length	for standard pipe size	price
G3116644	1"	6"	3/2"	<b>\$18.21</b>
G2262565	1 1/8"	6"	3/4"	<b>\$18.66</b>
G0501602	1 1/2"	6"	1"	<b>\$23.91</b>
G1506836	1 3/4"	6"	1"	<b>\$25.62</b>
G2411087	2"	6"	1 1/2"	<b>\$27.50</b>
G1858035	2 3/8"	4 1/2"	—	<b>\$31.21</b>



**DEWALT Brad Point Drill Bit**

- Carbon steel construction
- For use with wood

Item #	shank size	dia	overall length	pieces	price
G3084453	3/8"	3/8"	2 3/4"	2	<b>\$1.69</b>
G1255222	3/16"	3/16"	3 1/2"	1	<b>\$1.77</b>
G0742305	1/4"	1/4"	3 3/16"	2	<b>\$2.65</b>
G0752087	3/16"	3/16"	4 13/32"	2	<b>\$3.19</b>
G1773265	3/8"	3/8"	5 1/4"	2	<b>\$3.80</b>
G1079215	1/2"	1/2"	5 5/16"	2	<b>\$4.76</b>



**IRWIN SPEEDBOR Ship Auger Bit**

- Carbon steel with cutting edge alloy
- For use with 1/2" d handle and larger drills
- 17" overall length

Item #	shank size	dia	price
G1027275	3/8" hex shank	1/2"	<b>\$19.18</b>
G2649552	3/8" hex shank	3/8"	<b>\$21.06</b>
G1077447	7/16" hex shank	7/16"	<b>\$17.12</b>
G1389193	7/16" hex shank	3/8"	<b>\$20.67</b>
G0508882	7/16" hex shank	3/8"	<b>\$22.12</b>

**IRWIN UNIBIT Cobalt Step Drill Bit**

- Cobalt material

Item #	shank size	hole sizes	step thickness	price
G1552792	1/4"	13	1/8" to 1/2"	<b>\$24.89</b>
G2336083	3/8"	9	1/4" to 3/4"	<b>\$38.83</b>



**IRWIN SPEEDBOR Spade Bit**

- Carbon steel

1/4" Hex

Item #	dia	overall length	price
G3271563	3/8"	6"	<b>\$1.84</b>
G3342525	3/4"	6"	<b>\$2.47</b>
G1599053	1"	6"	<b>\$2.97</b>

1/4" Hex Quick Change

- For use with 3/8" or 1/2" drill

Item #	dia	overall length	price
G1231474	3/4"	6"	<b>\$1.68</b>
G1693142	1/2"	16"	<b>\$7.13</b>
G0950932	1"	16"	<b>\$8.67</b>

**KEO Counterbore**

- Built-in pilot
- Socket head cap screws
- 3 flutes
- Cobalt steel material
- For use in alloys, cast iron, stainless steel and titanium

1/2" Clearance

Item #	screw size	pilot dia	pilot length	overall length	price
G0495774	#5	0.156"	3/16"	3"	<b>\$41.72</b>
G2623661	3/16"	0.343"	3/8"	4 1/2"	<b>\$53.02</b>



**IRWIN UNIBIT High Speed Drill Bit**

- High speed steel
- Ensures true starts without walking even on curved surfaces

Item #	shank size	hole sizes	size	price
G2991344	3/4"	1	1/2"	<b>\$19.83</b>
G0606304	1/2"	1	1 1/8"	<b>\$34.69</b>



**IRWIN UNIBIT Tin Coated Step Drill Bit**

- High speed steel

Item #	shank size	hole sizes	size	step thickness	price
G2164294	1/4"	13	1/8" to 1/2"	1/32"	<b>\$16.83</b>
G1055214	3/8"	9	1/4" to 3/4"	1/16"	<b>\$48.46</b>



3/4" Clearance

Item #	screw size	pilot dia	pilot length	overall length	price
G0742113	3/16"	0.328"	3/8"	4 1/2"	<b>\$54.22</b>
G1121951	3/8"	0.390"	1/2"	5"	<b>\$65.62</b>

Close Fit

Item #	screw size	pilot dia	pilot length	overall length	price
G1107714	1/4"	0.250"	5/16"	4 1/2"	<b>\$39.88</b>
G0746645	1/2"	0.500"	1/2"	5"	<b>\$77.99</b>

**eZTIPS**  
technical resources

**DRILL BIT SELECTION GUIDE**

Ultimately, drilling a hole is a simple task. With all the different drill bit materials, points, lengths, and coatings available, knowing how to select them will make the job smoother, and extend the life of the tool. This guide will concentrate on the two most common styles of drill bit, the 118° Conventional Point (General Purpose) and 135° Split Point (Heavy Duty). It will also cover bit lengths, materials of construction, and coatings.

**Materials:** Materials refers to what the drill bit is made of. The chart below will show what application a given material is best suited for.

material	application
high speed steel (hss)	general purpose, carbon steel, ferrous and nonferrous metals
cobalt	stainless steel, armor plating, and other harder metals
carbide	difficult or abrasive materials like cast iron, fiberglass, and nonferrous metals

**Coatings:** In some instances, drill bits are given a coating to improve performance and tool life. The following information will explain the advantages of the four most widely used coatings for drill bits.

coatings	advantages
black oxide	most common coating type. helps retain drilling lubricants. not recommended for nonferrous metals like aluminum.
TiN coated	titanium nitride provides extra lubricity at the drill point, for higher drilling speeds and longer tool life.
TiAlN coated	titanium aluminum nitride, most effective when higher drill speeds and feed rates are required. works well on stainless steel, titanium, ferrous metals, and high-temperature alloys.
bright finish	no surface coating. flutes are polished for improved chip removal. works well for nonferrous materials like aluminum.



**WESTWARD Masonry Bit**

- Straight shank shape
- For drilling brick, cinder block, and tile

#	dia	overall length	drilling length	shank size	price
G3933431	3/8"	3"	2"	3/8"	<b>\$2.60</b>
G4133062	3/16"	4"	2 3/4"	3/16"	<b>\$2.38</b>
G4073781	1/4"	4"	2 3/4"	1/4"	<b>\$2.14</b>
G4084857	1/4"	6"	4 1/2"	3/4"	<b>\$2.80</b>
G4092252	3/8"	18"	16 1/4"	3/8"	<b>\$5.50</b>
G3932905	3/8"	6"	4 1/2"	3/8"	<b>\$7.86</b>

**VERMONT AMERICAN Hand Tap**

- Right hand thread direction
- Plug tap style
- High carbon steel material, uncoated finish

**UNF Thread Type**

#	size	pitch	overall length	thread length	shank dia	price
G0954931	1/4"	28	2 1/2"	1"	0.250/0.257"	<b>\$2.55</b>
G1131575	3/8"	24	2 3/16"	1 1/4"	0.376/0.381"	<b>\$3.68</b>
G3496202	1/2"	20	3 3/8"	1 2 1/2"	0.362/0.364"	<b>\$4.19</b>

**UNC Thread Type**

#	size	pitch	overall length	thread length	shank dia	price
G1783153	1/4"	20	2 1/2"	1"	0.250/0.257"	<b>\$2.62</b>
G2673106	3/8"	16	2 3/16"	1 1/4"	0.376/0.381"	<b>\$2.95</b>
G0670923	1/2"	13	3 3/8"	1 2 1/2"	0.362/0.364"	<b>\$4.19</b>

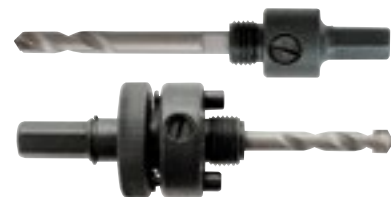

**MORSE Hole Saw Arbors with Pilot Drills**

- Carbon steel construction
- For use with carbide-tipped and tungsten hole saws

**Threaded**

- Fits 3/4" to 1 1/16" hole saws. 1/2-20 thread

#	chuck	shank	uses pilot	price
G2624237	3/8"	3/8" hex	G2487606	<b>\$5.78</b>

**Quick Change**

- Fits 1 1/4" to 6" hole saws. 5/8-18 thread

#	chuck	shank	uses pilot	price
G1361473	1/2"	7/16" hex	G2668041	<b>\$11.74</b>

**MORSE Hole Saw Arbors with Pilot Drills**

- Carbon steel construction
- For use with bi-metal hole saws

**Threaded**

- Fits 3/16" to 1 1/16" hole saws. 1/2-20 thread

#	chuck	shank	uses pilot	price
G3013726	3/4"	1/4" hex	G1548434	<b>\$7.77</b>
G1213003	3/4"	1/4" round	G0830891	<b>\$7.16</b>
G1812806	3/8"	3/8" hex	G1548434	<b>\$8.88</b>
G0834504	1/2"	7/16" hex	G0830891	<b>\$10.30</b>



**Quick Change**

- Fits 1 1/4" to 6" hole saws. 5/8-18 thread

#	chuck	shank	uses pilot	price
G0490472	3/8"	3/8" hex	G1548434	<b>\$12.03</b>
G1158762	1/2"	7/16" hex	G0830891	<b>\$12.54</b>

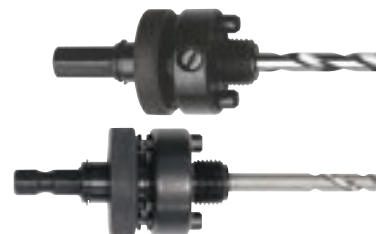

**MORSE Hole Saw Pilot Drill Bits**

- High speed steel
- Carbide tipped

#	length	shank	price
G2487606	2 3/4"	1/4"	<b>\$3.06</b>
G2668041	4"	3/4"	<b>\$3.20</b>

**ONSRUD High Performance Carbide Routing Single End Mills**

- Upcut spiral O-flute
- Carbide material
- Right handed
- Center cutting type
- 1/4" shank diameter

**List #63-600**

- Use for aluminum
- 1/4" diameter
- 3/4" cut
- 2 1/2" overall length

#	price
G1817076	<b>\$32.17</b>

**List #63-700**

- Use for cast acrylic, nylon, PVC
- 1/8" diameter
- 2" length

#	price
G2257412	<b>\$23.84</b>



**MORSE Hole Saw Pilot Drill Bits**

- Replacement for pilot drills on arbors
- High speed steel construction

#	length	shank	price
G1548434	3 3/16"	1/4"	<b>\$2.96</b>
G0830891	4 3/16"	1/4"	<b>\$3.07</b>

**CHICAGO-LATROBE Jobber Drill Bits**

- Cobalt steel construction
- 135° point angle

#	size	overall length	price
G3325917	3/32"	2 3/4"	<b>\$1.53</b>
G1207701	1/8"	2 3/4"	<b>\$1.86</b>
G2364354	5/32"	3 3/8"	<b>\$2.30</b>
G1762187	1 3/64"	3 3/4"	<b>\$2.54</b>
G2355132	3/16"	3 1/2"	<b>\$2.75</b>
G1854937	1 3/64"	3 3/8"	<b>\$3.63</b>
G1544006	7/32"	3 3/4"	<b>\$4.52</b>
G2375511	1/4"	4"	<b>\$5.00</b>





**WESTWARD Tile Hole Saw Kit**

- Carbide construction
- 8 pieces kit
- 2 1/4" cutting depth
- List sizes
- For ceramic tile

includes sizes 1 1/4", 2 1/8", 2 3/8", 2 7/8", 3 1/4"

#	price
G4916231	<b>\$70.72</b>



8  
PIECE

**MORSE Bi-Metal Hole Saw**

- Bi-metal construction
- Variable pitch
- For cutting holes in wood, plastic, nail-embedded wood, plywood, pipe, stainless steel, machinable metal

#	dia	price
G1697701	1"	<b>\$4.17</b>
G0635031	2"	<b>\$5.57</b>
G2354441	3"	<b>\$9.85</b>



**MILWAUKEE Electricians Hole Saw Kit**

- Ice hardened bi-metal
- 1 5/8" max cutting depth
- For wood, steel, plastic, stainless steel, aluminum, brass, copper, sheet metal

includes hole saws 3/8", 1 1/4", 1 3/8", 1 3/4", 2", 2 1/2" dia, 3/8" and 7/8" hex arbors, (2) pilot bits, arbor spacer and adapter

#	price
G0816392	<b>\$57.94</b>



10  
PIECE

**GREENLEE Hole Cutter Kit**

- Tungsten carbide tips with hardened steel backer
- 3/16" max cutting depth
- For stainless steel, mild steel, copper, aluminum and brass

includes 3/8", 1 1/8", and 1 3/8" hole cutters with arbor, pilot drill bit, hex key and plastic carrying case

#	price
G1904436	<b>\$71.69</b>



6  
PIECE

**MILWAUKEE Wood Hole Saw Kit**

- High speed steel
- includes 2 3/8", 2 1/4", 2 3/8", 3", 3 5/8", 4 1/4", (1) arbor, (2) pilot bits, diamond file and hex wrench

#	price
G2914807	<b>\$146.62</b>



10  
PIECE

**DEWALT Plumbers Hole Saw Kit**

- Bi-metal
- HSS teeth
- Max cutting depth 1.451" to 1.84"
- includes 3/4", 7/8", 1 1/8", 1 1/2", 1 3/4", 2 1/4" cutters, small and large quick change arbors

#	price
G7639913	<b>\$74.63</b>



9  
PIECE

**MILWAUKEE Annular Cutter Kit**

- Diameter: 9/16", 5/8", 1 1/16", 1 3/16", 1 5/16", 1 7/16"
- 1" cutting depth
- For cutting steel plate stainless steel, cast iron

includes 3/16", 5/8", 1 3/16", 1 3/16", 1 5/16", 1 7/16" bits, (1) pilot bit and case

#	price
G1469596	<b>\$179.47</b>



7  
PIECE

28  
PIECE



**MILWAUKEE General Purpose Hole Saw Kit**

- Ice hardened bi-metal
- Bi-metal hole saws, high speed steel pilot bits, alloy steel arbors
- For wood, steel, plastic, stainless steel, aluminum, brass, copper, sheet metal

includes hole saws 3/4", 7/8", 1", 1 1/8", 1 1/4", 1 3/8", 1 1/2", 1 3/4", 2, 2 1/8", 2 1/4", 2 3/8", 2 3/4", 2 7/8", 3", 3 1/4", 3 3/8", 3 3/4", 3 7/8", 4 1/4", 4 1/2", 4 3/4" dia, (1) 3/8" and (2) 7/16" hex arbors and (3) pilot bits

#	price
G0742917	<b>\$366.21</b>

**MORSE Carbide Hole Saw**

- Tungsten carbide grit
- Positive rake teeth
- 1 1/2" cutting depth
- For abrasive materials such as ceramics, fiberglass, hardwoods, cast iron, composites

#	dia	price
G0954703	1"	<b>\$20.98</b>
G3250152	2 1/2"	<b>\$32.01</b>
G1509611	3 3/4"	<b>\$39.09</b>





# TOOLS



### GENERAL Tap Wrench Set

- Steel
- ¼", ½" cutting sizes
- Machine finish
- 0 to ½" size range

includes (1) t-handle tap wrench 0 to ¼" (1.6 to 6.3 mm), 3½" (88 mm) long, (1) t-handle tap wrench 12 to ½" (6 to 12 mm), 4¾" (106 mm) long, guide and case

**#** price  
G3644137 **\$70.47**

### WESTWARD Tap and Die Set

- High carbon steel
- 28 cutting sizes
- 1½" and 2" round adjustable die, 1", 1½" and 2" OD solid die

includes (2) straight tap wrenches, t-handle tap wrench, screw pitch gauge, screwdriver, and 1", 1½" and 2" die stocks

**#** price  
G1380845 **\$253.57**



**64**  
PIECE

### VERMONT AMERICAN Tap and Die Set

- Carbon steel
- Right hand
- BSP, metric
- 3 mm x 12 mm, ½"-28 BSP size range

includes 1" hex dies (3 mm x .50 taper to 8 mm x 1.25 taper, 9 mm x 1.00 plug to 12 mm x 1.75 plug, ½"-28 BSP pipe), taper wrench (tap sizes #4 to ½"), die stock (½" round or hex dies), t-handle tap wrench (tap sizes #0 to ¼"), t-handle tap wrench (tap sizes ¼" to ½"), metric thread gauge (0.45 to 2.50 mm threads) and #5 screwdriver

**#** price  
G0963654 **\$103.94**

**40**  
PIECE



**75**  
PIECE



### VERMONT AMERICAN Tap and Die Set

- Carbon steel
- Right hand
- 75 piece set
- 4½", M3 to M9 size range

includes (34) dies, wrench for tap sizes #4-½", t-handle wrenches for tap sizes #0-¼" and ¼" to ½", die stock for 1" rd or hex dies, std and metric thread gauges and #5 screwdriver

**#** price  
G1801755 **\$169.07**

**53**  
PIECE



### IRWIN HANSON Tap and Hex Die Set

- Raw steel
- Machine screw/fractional
- 1" and 1½" hex die type

includes adjustable/nonadjustable t-handle tap wrench, adjustable and plain die stock, 2-in-1 tap wrench, (18) leaf standard thread pitch gauge and extra plastic case

**#** price  
G4223143 **\$258.70**

### IRWIN HANSON Die Wrench

- Adjustable guide for 1" hex dies
- 1" size
- 9" length
- Accommodates 1" single hex dies, 1" single hex self-aligning dies, small and medium tap sockets

**#** price  
G2730944 **\$37.95**



### IRWIN HANSON Adjustable Tap Set

- Carbon steel
- Plain finish
- No. 6 to ½" size range
- includes (2) adjustable tap sockets w/⅜" square drive and tap range from #6 to ½"

**#** price  
G1322054 **\$22.18**



**40**  
PIECE



### VERMONT AMERICAN Tap and Die Set

- Carbon steel
- Right hand
- 4½" NC, 10½" NF, ½" npt size range

includes (17) dies, die stock for 1" rd or hex dies, tap wrench for tap sizes #4-½", t-handle tap wrench for tap sizes #0-¼", t-handle tap wrench for tap sizes ¼" to ½", thread gauge for 10-40 US threads and #5 screwdriver

**#** price  
G3346174 **\$98.60**

### KLEIN TOOLS Tapping Tool

- 6 sizes
- 6-32, 8-32, 10-32, 10-24, 12-24, ¼"-20 tap sizes
- 7¾" overall length
- Cushion grip handle
- ASME B94.9-1999 STANDARDS

**#** price  
G1643187 **\$21.42**



### CLEVELAND Round Die Stock

- High speed steel material
- #5 size
- 1.5" OD
- ¾" thickness

**#** price  
G4412965 **\$49.94**





11  
PIECE



**DREMEL EZ Lock Cut Off Wheel Kit**  
 • Cutting floor tile, wood, reslotting screws, metal and plastic  
 includes (3) no. G0578444 thin cut metal cutting wheels, (3) no. G1594573 plastic cutting wheels, (4) no. G0313397 metal cutting wheels and no. G1477411 EZ Lock mandrel  
 # price  
 G3226946 **\$25.55**

**DREMEL EZ Lock Cut Off Wheel**  
 • Cuts metal and plastic  
 • 1½" diameter  
 • Fiberglass construction  
 • 12 pack  
 # price  
 G0481223 **\$23.21**



**DREMEL EZ Lock Cut Off Wheel**  
 • Cuts metal and plastic  
 • 1½" diameter  
 • Fiberglass construction  
 • 5 pack  
 # price  
 G0313397 **\$10.31**



**DEWALT Cut Off Wheel**  
 • Straight grinding wheel  
 • Aluminum oxide abrasive material  
 # grit dia price  
 G1994027 36 3" **\$1.19**  
 G7420061 60 4" **\$1.40**

**DREMEL Cut Off Wheel**  
 • 1½" diameter  
 • G2159123 mandrel required  
 20 package quantity  
 # price  
 G2951706 **\$4.10**  
 36 package quantity  
 # price  
 G2578292 **\$4.50**



**NORTON Depressed Center Wheel**  
 • Type 27  
 • Non-woven, cleaning and stripping  
 • Silicon carbide material  
 # arbor size price  
 G0934035 ½" **\$9.52**  
 G3144687 ½"-11 **\$10.82**

**UNITED ABRASIVES-SAIT Depressed Center Wheel**  
 • Type 27  
 • Grinding wheel  
 • Aluminum oxide  
 • 4½" diameter

#	arbor size	series	price
G0739234	¾"	A24R	<b>\$1.77</b>
G1031861	¾"	A24N	<b>\$1.97</b>
G1761137	¾"-11	A24R	<b>\$3.28</b>



**3M Depressed Center Wheel**  
 • Double reinforced wheel  
 • Type 27  
 • 36 grit  
 • 4" diameter  
 # arbor size price  
 G5243917 ¾" **\$3.47**  
 G5243874 ¾" **\$5.09**

**3M Depressed Center Grinding Wheel**  
 • Double reinforced wheel  
 • Type 27  
 • 36 grit  
 • ½"-11 arbor  
 • Ferrous metal, stainless, aluminum application

#	dia	max rpm	price
G5243646	6"	10,200	<b>\$16.58</b>
G5243655	7"	8,500	<b>\$17.64</b>
G5243673	9"	6,650	<b>\$23.18</b>





# JANITORIAL & GROUNDS MAINTENANCE



## TOP BRANDS



JANITOR  
CARTS

pg  
163



WASTE  
CONTAINERS

pg  
164



CLEANERS AND  
DEGREASERS

pg  
166



SHOP  
TOWELS

pg  
167



TOILET PAPER  
AND DISPENSERS

pg  
168



VACUUMS

pg  
173



PRESSURE  
WASHERS

pg  
174



BROADCAST  
SPREADERS

pg  
177



PAINTS  
AND PRIMERS

pg  
182



SPRAY  
GUNS

pg  
186



**TOLCO**

**Trigger Sprayer Bottle Multi-Pack**

- Plastic
- Color coded bottles for easy identification
- 24 oz bottle
- 5 pack

*includes bilingual preprinted and color coded, trigger sprayer bottles for (1) disinfectant, (1) degreaser, (1) glass cleaner, (1) all purpose cleaner and (1) multi choice*

#	price
G4245403	<b>\$18.47</b>



**TOUGH GUY**

**Spray Bottles and Trigger Sprayer**

**Trigger Sprayer**

- Fits 24 or 32 oz bottle

#	price
G3437463	<b>\$2.15</b>

**Preprinted Bottles**

- Plastic
- White

#	size	price
G1058373	24 oz	<b>\$2.53</b>
G1384546	32 oz	<b>\$2.68</b>



**TOLCO**

**Trigger Sprayer**

- Plastic
- Gray
- Fits 32 oz bottle
- 9 1/4" size

#	price
G2942992	<b>\$3.41</b>



**SHOWA BEST**

**Chemical Resistant Gloves**

- Latex, 18 mil thick
- 12" length
- Rolled cuff, flock lining
- 12 pack

▶ **MORE CHEMICAL RESISTANT GLOVES ONLINE**

#	size
G0025855	10
G0025846	8

pack **\$9.49**



**RUBBERMAID**  
**Cleaning Buckets**

- HDPE
- Round
- Gray
- Pour spout

#	capacity	diameter	height	price
G4115246	10 qt	10 1/2"	10 3/4"	<b>\$8.86</b>
G4205144	14 qt	12"	11 1/4"	<b>\$13.35</b>



**RUBBERMAID**  
**Janitor Cart**

- Structural web plastic
- (2) 8" wheels, (2) 4" casters
- 21 3/4" w x 46" l x 38 3/8" h

*includes bumper and zippered yellow vinyl bag*

#	price
G2184454	<b>\$170.94</b>

**Replacement Bag**

- Yellow vinyl
- 10 1/2" w x 17 1/4" l x 30 1/2" h

#	price
G0515094	<b>\$44.51</b>



**TOUGH GUY**

**Janitor Cart**

- Polypropylene
- (2) 8" non-marking wheels
- (2) 3" swivel casters
- 19 3/4" w x 56" l x 38" h

*includes yellow zippered vinyl bag*

#	price
G0615903	<b>\$197.06</b>

**HONEY-CAN-DO**

**3 Tier Laundry Cart**

- Steel
- White
- (4) swivel casters
- 8" w x 24" l x 32" h

#	price
G4587755	<b>\$16.33</b>



**TOUGH GUY**

**Blue Janitor Cart**

- Zinc plated
- 3 shelves
- (4) 4" casters
- 20 1/4" w x 38" l x 40" h

*includes vinyl bag*

#	price
G0413393	<b>\$1,047.75</b>

**RUBBERMAID**  
**Housekeeping Caddy**

- Plastic
- 10 7/8" h x 15" l x 7 3/8" h
- Black
- Holds (8) 32 oz spray bottles or other tools

#	price
G4187723	<b>\$17.21</b>



**RUBBERMAID**

**Microfiber Housekeeping Cart**

- Structural web plastic and aluminum construction
- (2) 8" wheels, (2) 4" non-marking swivel casters
- 22" w x 48 1/4" l x 53 1/2" h

*includes (2) removable 10 qt disinfecting caddies*

#	price
G1020747	<b>\$502.59</b>



**RUBBERMAID**

**Cleaning Equipment Cart**

- Blue self-adhesive embossable aluminum
- (2) 8" wheels, (2) 4" casters
- 21 3/4" w x 46" l x 38 3/8" h

*includes yellow zippered vinyl bag*

#	price
G3960661	<b>\$170.94</b>



# JANITORIAL & GROUNDS MAINTENANCE

**TOUGH GUY**  
**Deskside**  
**Recycling Containers**

- Rectangular LLDPE
- Blue receptacles with white recycle symbol
- Rolled rim for easy lifting and pulling
- **MINIMUM 30% POST-CONSUMER RECYCLED CONTENT**



Z#	capacity	price
G1677112	3½ gal	<b>\$7.04</b>
G1501482	7 gal	<b>\$8.06</b>
G0504043	10¼ gal	<b>\$14.92</b>

**RUBBERMAID**  
**Small Open-Top Waste Receptacles**

- Rectangular LLDPE
- Black



Z#	capacity	dimensions	price
G1540366	3 gal	8¼" w x 11¾" l x 12½" h	<b>\$5.18</b>
G3183047	7 gal	10¼" w x 14¾" l x 15" h	<b>\$5.58</b>

**RUBBERMAID**  
**Stainless Steel Receptacles**

- Open-top
- Round shape
- Satin finish



Z#	capacity	height	diameter	price
G3852387	5 gal	15"	10"	<b>\$69.39</b>
G3851416	15 gal	28"	15"	<b>\$219.29</b>



**RUBBERMAID**  
**Roll-Out Containers**

- HDPE
- 50 gal capacity
- UV protectant finish
- Hinged top, heavy-duty 8" wheels
- **ANSI STANDARDS**

Z#	color
G0062623	gray with black lid
G0062641	blue

each **\$109.45**



**TOUGH GUY**  
**Square Container**

**Base**

- Polyethylene construction
- 19 gal capacity
- Gray
- 15¾" w x 15¾" l x 21¾" h

Z#	price
G0099766	<b>\$45.64</b>

**Drop Top Lid**

- Fits 19 and 23 gal size base

Z#	price
G0099757	<b>\$29.85</b>



**TOUGH GUY Outdoor Utility Containers**

- Durable galvanized sheet steel
- Silver
- Round shape

**Bases**

Z#	capacity	diameter	height	price
G2881882	20 gal	17½"	23¾"	<b>\$20.14</b>
G2200572	31 gal	20½"	27"	<b>\$22.58</b>

**Lids**

Z#	fits	price
G3274817	20 gal container	<b>\$7.85</b>
G1536893	31 gal container	<b>\$8.51</b>

**RUBBERMAID Brute Waste Container Bases**

- LLDPE
- Round shape
- Built-in handles for easy lifting
- UV protectant finish
- **NSF STANDARDS**

Z#	Z#	Z#	Z#	Z#	capacity	diameter	height	price
White	Grey	Yellow	Red	Green				
G0071014	G0071023	G0071032	G0071041	G0071057	10 gal	15"	17"	<b>\$15.18</b>
G0071136	G0071127	G0071145	G0071172	G0071154	32 gal	22"	27¼"	<b>\$30.25</b>
G0071285	G0071242	G0071251	G0071267	G0071276	55 gal	26½"	33"	<b>\$71.71</b>

**RUBBERMAID Brute Waste Container Lids**

- Round flat top

Z#	Z#	Z#	Z#	Z#	fits	diameter	price
White	Grey	Yellow	Red	Green			
G0062185	G0062194	G0062203	G0062212	G0062221	10 gal container	16"	<b>\$5.89</b>
G0062264	G0062307	G0062273	G0062291	—	32 gal container	22¼"	<b>\$9.82</b>
G0099705	G0099723	G0099714	G3833776	G0099696	55 gal container	26¾"	<b>\$23.96</b>



**RUBBERMAID**  
**5-Wheel Container Dolly**

- Rubber and steel
- Fits 20 to 55 gal containers, 250 lb load capacity
- 18¼" diameter
- 5 heavy-duty 3" swivel casters

Z#	price
G3165994	<b>\$47.41</b>



**TOUGH GUY**  
**Portable Bag Holder**

- Tensile zinc plated steel
- Silver
- 39 to 45 gal bag capacity
- 2" w x 16" l x 30" h



#	price
G3706972	<b>\$17.36</b>

**UNGER**  
**NiftyNabber Pro**

- Steel squeeze handle
- Powerful claws, and ergonomic grip

#	length	price
G2441792	18"	<b>\$22.98</b>
G2816694	36"	<b>\$25.75</b>
G3366842	51"	<b>\$27.53</b>
G3432064	96"	<b>\$49.98</b>

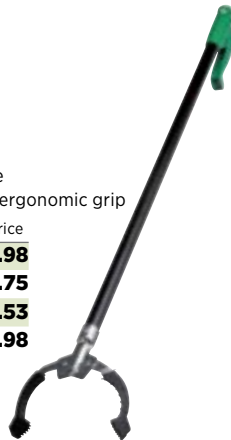

**EAGLE**  
**Yellow Cigarette Receptacles**

- Galvanized steel with polyethylene tube
- 2 openings
- FM APPROVED

#	capacity	base diameter	height	price
G0003866	2 gal	11"	35"	<b>\$40.94</b>
G0003884	5 gal	12"	40"	<b>\$45.59</b>

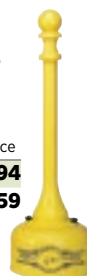

**JUSTRITE**  
**Black Cigarette Receptacle**

- Polyethylene construction with tie down notches
- 4 gal capacity
- 16½" base diameter, 38½" height
- FM APPROVED, ADA COMPLIANT

#	price
G0004067	<b>\$41.83</b>



**BEHRENS**  
**Utility Container Trolley**

- Fits (2) 31 gal containers
- Metal
- 250 lb capacity
- 43" x 32"
- includes hardware and rubber wheels

#	price
G1063176	<b>\$39.39</b>

**DOGIPOT**  
**Pet Waste Bags**

- Polyethylene
- Green bags
- 0.7 mil thick
- 8" x 13" bags
- 200 bags per pack
- 10 pack

#	price
G3902841	<b>\$68.67</b>



**GLAD**  
**Drawstring Trash Can Liners**

- LLDPE
- 0.9 mil thick
- 13 gal capacity, 25 lb max load
- 24" x 27½"
- 100 pack

#	price
G1396114	<b>\$18.42</b>



**BERRY PLASTICS** Trash Can Liners

- LLDPE
- 2.0 mil thick
- Star seal
- 96 gal capacity
- 52" x 75"
- 50 pack

#	price
G4183356	<b>\$64.99</b>



**NORTH AMERICAN PLASTICS**  
**Orange Trash Can Liners**

- LLDPE
- 5.5 mil thick, 36" x 63"
- Flat seal
- 55 gal capacity, 150 lb max load
- Cored roll
- 50 pack

#	price
G4739007	<b>\$134.42</b>



**TOUGH GUY**  
**High-Density Polyethylene Liners**

- Clear bags, 12 micron thick
- Star seal
- 45 lb max load
- MORE SIZES ONLINE

#	capacity	size	count	price
G1335162	33 gal	33" x 40"	250	<b>\$44.18</b>
G1908286	40-45 gal	40" x 48"	250	<b>\$69.75</b>
G1302375	55 gal	36" x 60"	200	<b>\$71.33</b>

**TOUGH GUY**  
**Contractor Clean-Up Bags**

- LLDPE
- 3.0 mil thick
- Star seal
- 42 gal capacity, 120 lb max load
- 33" x 48"
- 20 bags per roll

#	price
G3399015	<b>\$27.38</b>



**eZTIPS**  
technical resources

**TRASH LINERS AND BAG SELECTION GUIDE**

While choosing a trash can liner and bag may seem as simple as finding one that will fit your waste can, there are a handful of terms you must familiarize yourself with and consider to ensure that your selection will provide the best results.

Knowing how to measure a trash liner will help you make sure you select the correct size for your trash container.

**Bag Length:** Use the height of the container, plus ½ of the diameter of the container bottom, plus 3" (for overhang). For square or rectangular containers, use the diagonal of the container bottom, rather than the diameter.

**Bag Width:** Use ½ of the outer circumference of the container.

Bags can come in either a coreless roll, or flat pack box, for ease of storage and distribution.

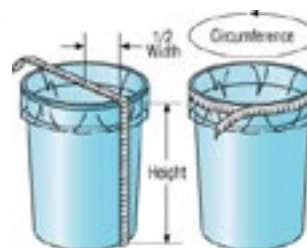

Liners may also be specified in thickness in either mils or microns. To convert mils to microns, multiply the mils by 25.4, or convert microns to mils by dividing microns by 25.4.



# JANITORIAL & GROUNDS MAINTENANCE

## SIMPLE GREEN Cleaner Degreaser

- Water-based liquid concentrates are nontoxic
- Dilution varies by application
- Sassafras fragrance
- ■ READILY BIODEGRADABLE PER OECD OR ASTM STANDARDS; AND VOC LEVEL PER SCAQMD REQUIREMENTS

Z#	size	price
G4603444	24 oz	<b>\$5.50</b>
G4602315	1 gal	<b>\$19.85</b>
G4553762	2.5 gal	<b>\$37.12</b>
G4602297	5 gal	<b>\$54.85</b>



## MICROBAN Germicidal Cleaner Concentrate

- 2 oz/gal recommended dilution
- Mint fragrance
- 1 gal jug
- ■ EPA STANDARDS

Z#	price
G2421571	<b>\$31.00</b>



## CHEMTRONICS Aerosol Cleaner Degreaser

- 12.5 oz net weight
- Mild hydrocarbon solvent
- 700g/L VOC content
- -20°F flash point
- ■ HMIS, NFPA, OSHA STANDARDS AND ROHS COMPLIANT

Z#	price
G2044366	<b>\$18.42</b>



## GOOF OFF Professional Strength Remover

- Can remove adhesive, glue, dried latex paint, asphalt, tar, crayon, pen, marker, lipstick, road grime, bugs, and tree sap
- Ready to use
- 16 oz can

Z#	price
G3524123	<b>\$5.21</b>



## MICROBAN Disinfectant Spray Plus

- Formula acts against bacteria, mold, mildew, and fungi
- Ready to use
- 1 gal jug

Z#	price	fragrance
G1767787	<b>\$40.00</b>	unscented
G2564186		mint

each



## SIMPLE GREEN Aircraft and Precision Cleaner Degreaser

- Water-based, non-flammable formula
- Dilution varies by application
- Removes grease, oil, dirt, pollution, insect residue, and impact soils
- ■ VOC CONTENT SCAQMD METHOD 313, 2.04 PERCENT, BOEING SPEC D6-17487P FOR AIRCRAFT EXTERIOR AND GENERAL CLEANING STANDARDS

Z#	size	price
G2572683	1 gal	<b>\$17.43</b>
G1695355	5 gal	<b>\$79.99</b>



## BLUE MAGIC Metal Polish Cream

- Contains a metal protecting agent
- For use on brass, copper, sterling silver, aluminum, stainless steel, and gold
- Paste form
- 19 3/8 oz tub

Z#	price
G0778653	<b>\$7.19</b>



## SIMPLE GREEN Disinfectant Deodorizer

- Hospital-grade germicidal cleanser
- For use on hard surfaces
- Ready to use
- Herbal, light pine fragrance

Z#	size	price
G1809035	32 oz	<b>\$6.99</b>
G3246284	1 gal	<b>\$19.99</b>
G3073655	5 gal	<b>\$60.99</b>



## GOO GONE Pro-Power Multi-Purpose Degreaser

- Removes gummy, sticky and gooey substances
- Ready to use
- Citrus fragrance
- For use on hard surfaces, carpeting, upholstery, and clothing
- ■ HMIS, NFPA, OSHA STANDARDS

Z#	size	pack	price
G3300351	8 oz	12	<b>\$34.98</b>
G2590831	1 qt	1	<b>\$6.99</b>



## 3M Stainless Steel Cleaner and Polish

- For use on stainless steel, chrome, laminated plastics, and aluminum surfaces
- 21 oz aerosol can
- Lime fragrance
- Contains no ozone depleting chemicals
- ■ USDA STANDARDS

Z#	price
G2730953	<b>\$10.86</b>



## CRC Industrial Contact Cleaner

- 11 oz aerosol can
- Less than 0°F flash point
- 75%, 495 g/L VOC content
- ■ NSF(R) K2 REGISTERED STANDARDS AND ROHS COMPLIANT

Z#	price
G2810902	<b>\$10.07</b>



## CLR Multi-Surface Cleaner

- Ready to use
- 28 oz bottle
- Fragrance free
- ■ EPA STANDARDS

Z#	price
G3262917	<b>\$5.94</b>



## IRON OUT Rust Stain Remover

- For use on clothes, sinks, toilets, and dishwashers
- Powder formula
- Fragrance free
- 152 oz plastic bottle
- Variable dilution

Z#	price
G1043192	<b>\$22.82</b>





**TOUGH GUY Cloth Rags**  
 • Recycled cotton t-shirt rags  
 • Assorted colors and various sizes  
 • 50 lb box

Q # price  
 G4273683 **\$114.94**

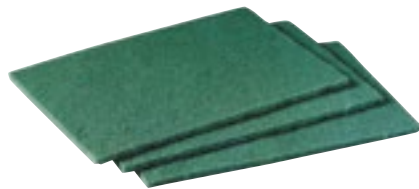

**3M Scotch-Brite Scouring Pads #96**  
 • Synthetic pads  
 • 6" x 9"  
 • 20 pack

Q # price  
 G1776092 **\$12.01**

**PDI Germicidal Disinfecting Wipes**  
 • 55% alcohol, latex free, bleach free and phenolic free  
 • 160 wipes per canister  
 • 6" x 6 3/4" sheet size  
 • ■ EPA STANDARDS

Q # price  
 G4099943 **\$8.03**



**GEORGIA-PACIFIC Brawny Industrial Shop Towels**  
 • Double re-creped  
 • Perforated, poly wrapped roll  
 • 84 sheets per roll  
 • 11" x 9 5/16" sheet size  
 • 20 pack

Q # price  
 G0398885 **\$57.32**



**SCRUBS Hand Cleaning Towels**  
 • Waterless, fortified with aloe, vitamin E and alcohol free  
 • Citrus scent  
 • 72 wipes per bucket  
 • 10" x 12" sheet size

Q # price  
 G5192521 **\$11.76**



**WYPALL Waterless Cleaning Wipes**  
 • Hand cleaning wipes  
 • Citrus fragrance  
 • 75 wipes per bucket  
 • 10 1/2" x 9 1/2" sheet size

Q # price  
 G3446581 **\$10.72**



**SCOTT Rags-in-a-Box**  
 • Double re-creped  
 • 200 sheets per box  
 • 10" x 13" sheet size

Q # price  
 G3076367 **\$11.86**



**PURELL Hand Sanitizing Wipes**  
 • 100 wipes per box  
 • 5" x 7" sheet size

Q # price  
 G3128851 **\$4.37**



**WYPALL Wiper Roll**  
 • Hydroknit material  
 • 475 sheets per roll  
 • 12 1/2" x 13 5/8" sheet size

Q # price  
 G1293747 **\$53.36**



**SCOTT Shop Towels**  
 • Double re-creped  
 • Perforated roll  
 • 55 sheets per roll  
 • 11" x 10 3/8" sheet size

Q # price  
 G1771052 **\$2.44**



**GYM WIPES Disinfectant Wipes and Dispenser**

**Dispenser**  
 • Smoke gray plastic, wall mount  
 • Hands free, centerpull dispensing  
 • 700 to 800 wipes capacity  
 • 10" w x 10" d x 12 1/2" h

Q # price  
 G3012195 **\$39.88**



**Gym Wipes Refill**  
 • PH-balanced phenol and alcohol free  
 • Fresh scent  
 • 700 wipes per container  
 • 8" x 7" sheet size  
 • ■ VOC COMPLIANT

Q # price  
 G1104275 **\$40.30**



**Antibacterial Force Wipes Refill**  
 • Lemon scent  
 • 800 wipes per container  
 • 6" x 8" sheet size

Q # price  
 G0485371 **\$53.04**



**D-LEAD D-Wipe Towels**  
 • Hand cleaning towels  
 • Aloe formula  
 • Citrus fragrance  
 • 40 wipes per canister  
 • 6" x 8" sheet size

Q # price  
 G4136045 **\$5.27**



**GOJO Original Formula Hand Cleaner**  
 • Cream, emollients formula  
 • Unscented  
 • 4.5 lb container  
 • For heavy grease, tar and oil removal  
 • 6 pack

Q # price  
 G1948572 **\$81.66**





MORE THAN 800,000 ITEMS ONLINE

# JANITORIAL & GROUNDS MAINTENANCE

## TOUGH GUY Toilet Seat Dispensers and Covers

### Dispenser

- Plastic
  - Holds 500 half fold toilet seat covers
  - 16 1/4" w x 2 1/2" d x 11 1/2" h
- includes screw pack

Z#	price
G1575987	<b>\$11.48</b>

### Covers

- White, half fold covers
- 14 1/4" x 17 1/4"
- 250 covers/box
- 20 pack

Z#	price
G1108222	<b>\$76.80</b>



## HOSPECO Toilet Seat Cleaner

- Liquid formula
- 300 mL pack
- Fragrance free
- 6 pack
- ■ MSDS STANDARDS

Z#	price
G3492316	<b>\$56.43</b>



## TOUGH GUY Bathroom Cleaner

- Ready to use
- 1 qt bottle
- Fresh scent
- 1% VOC content
- ■ EPA STANDARDS

Z#	price
G2918955	<b>\$2.81</b>



## GREEN WORKS 99% Naturally Derived Toilet Bowl Cleaner

- Ready to use
- 24 oz bottle
- 12 pack
- ■ EPA STANDARDS

Z#	price
G0586607	<b>\$57.06</b>



## CLOROX Toilet Bowl Cleaner

- Sodium hydrochloric formula
- Ready to use
- 24 oz bottle
- Fresh fragrance
- 12 pack

Z#	price
G1049456	<b>\$28.92</b>



## GEORGIA-PACIFIC Rollmastr Bathroom Tissue

- Standard size
- 2-ply
- (770) 4" x 4" sheets per roll
- 1 3/4" roll diameter
- 250' roll length
- 48 pack

Z#	price
G3349656	<b>\$54.06</b>



## RUBBERMAID SeBreeze 9000 Aerosol Dispenser and Canisters

### Aerosol Dispenser

- Metered, 800 cu-ft coverage
- Wall mount
- 3 1/4" w x 4 3/4" l x 7 1/2" h
- Requires (2) D batteries – NOT INCLUDED

includes keyless lock-on cabinet

Z#	price
G2480064	<b>\$51.07</b>

### Variety Pack Canister Set

includes (2) country linen, (2) citrus breeze and (2) spring garden fragrance cans

Z#	price
G3153701	<b>\$86.11</b>



## TOUGH GUY Sanitary Napkin Receptacle

- Wall mount
- White

includes removable rigid liner and mounting hardware

Z#	price
G0569572	<b>\$43.16</b>



## TOUGH GUY Toilet Bowl Mop

- Acid-resistant polypropylene strands
- 14" plastic handle
- White

Z#	price
G0908573	<b>\$1.88</b>



## WINGITS Toilet Paper Holders

- Wall mount
- Stainless steel
- Single roll capacity
- 6" w x 3/4" d x 1 1/2" h

includes mounting screws

Z#	style	price
G4391782	single post	<b>\$42.19</b>
G4391843	double post	<b>\$47.37</b>

## GEORGIA-PACIFIC Angel Soft Ultra Bathroom Tissue

- Standard size
- 2-ply, (400) 4 1/2" x 4" sheets per roll
- 1 3/4" roll diameter, 133' roll length
- 60 pack

Z#	price
G1159112	<b>\$60.53</b>



## LYSOL Disinfectant Spray

- Ready to use
- Kills germs, and helps eliminate odors
- 19 oz aerosol can
- 12 pack

Z#	scent	price
G2100716	original	
G1741022	fresh	
G2364092	crisp linen	
G3187484	country	

pack **\$71.16**



## GEORGIA-PACIFIC Jumbo Bathroom Tissue Dispensers

- Translucent gray color
- Plastic
- Fits 9" jumbo roll tissue
- Wall mount

Z#	capacity	size	price
G2348586	single roll	11" w x 6" d x 11" h	<b>\$15.48</b>
G1165351	double roll	20" w x 5 1/2" d x 11 1/2" h	<b>\$19.99</b>



## GEORGIA-PACIFIC Jumbo Bathroom Tissue

- 9" diameter jumbo roll
- 1-ply
- 2000' roll length
- 3 1/2" sheet size
- 8 pack

Z#	price
G3171043	<b>\$30.19</b>



## UNGER Toilet Bowl Brush and Holder

- Red bristle brush, with gray handle and holder
- Plastic handle and holder with nylon fill brush
- 3 1/2" brush diameter
- 26" overall length

Z#	price
G2247131	<b>\$23.09</b>





**GOJO TFX Touch-Free Dispensing Systems**

- Plastic
- Uses 1200 mL foam soap refills
- Wall mount
- Requires batteries
- 6 3/8" w x 4 7/16" d x 11 1/4" h
- ■ ADA COMPLIANT, UL/CE REGISTERED



#	color	price
G3120704	black	
G2517006	dove gray	

each **\$31.17**

**GOJO Premium Foam Hand Cleaner**

- 1200 mL foam soap refill
- Rich, gentle formula
- 2 pack
- ■ ADA, UL/CE STANDARDS



#	price
G3219361	<b>\$43.50</b>

**PURELL TFX Touch-Free Dispenser**

- Uses liquid or foam 1200 mL refills
- Plastic, wall mount
- Requires batteries
- 6 3/8" w x 4 7/16" d x 11 1/4" h
- ■ ADA COMPLIANT, UL/CE REGISTERED



#	price
G2030296	<b>\$31.17</b>

**PURELL Advanced Instant Hand Sanitizer Foam**

- Non-aerosol foaming formula
- Waterless
- 1200 mL refill
- 2 pack



#	price
G3646273	<b>\$65.56</b>

**PURELL NXT Maximum Capacity Dispenser**

- Manually dispenses soap with single-hand push
- Plastic, wall mount
- 2000 mL capacity
- 6 5/8" w x 4 3/4" d x 10 5/8" h
- ■ ADA COMPLIANT



#	price
G2811444	<b>\$7.80</b>

**PURELL Advanced Instant Hand Sanitizer Gel**

- Alcohol-based hand sanitizer
- Waterless
- 2000 mL refill
- 4 pack
- ■ FDA STANDARDS



#	price
G3746364	<b>\$79.93</b>

**GEORGIA-PACIFIC Envision Facial Tissue**

- 2-ply white tissue
- 100 sheets/box
- 8" x 8 3/8" sheet size
- 30 pack
- 100% TOTAL RECYCLED CONTENT, ECOLOGO CERTIFIED



#	price
G2251216	<b>\$27.24</b>

**WORX ALL-NATURAL HAND CLEANER Powdered Hand Soap Dispenser**

- Plastic
- Push operation method with adjustable spout
- 3.0-4.5 lb capacity
- 4" w x 5" d x 4" h
- includes mounting hardware



#	price
G4602595	<b>\$20.94</b>

**WORX ALL-NATURAL HAND CLEANER Powdered Hand Soap Refills**

- Light juniper fragrance
- ■ READILY BIODEGRADABLE PER OECD OR ASTM STANDARDS
- GREEN SEAL CERTIFIED



#	size	price
G4612562	3 lb	<b>\$47.91</b>
G4556431	4.5 lb	<b>\$53.48</b>

**ABILITY ONE Brown Single-Fold Paper Towels**

- 250 sheets/roll, 1-ply
- 16 pack
- 100% TOTAL RECYCLED CONTENT



#	price
G2141684	<b>\$25.57</b>

**GOJO FMX Soap Dispenser**

- Plastic, wall mount
- Push operation method
- 1250 mL refill capacity
- 6" w x 4" d x 10 1/2" h
- ■ ADA COMPLIANT



#	price
G2754963	<b>\$6.86</b>

**GOJO FMX Soap Refill**

- 1250 mL foam soap refill
- Cranberry fragrance
- 3 pack
- ■ ADA COMPLIANT



#	price
G2769444	<b>\$44.15</b>

**GEORGIA-PACIFIC SofPull Centerpull Towel Dispensers**

- Wall mounted plastic dispensers
- Hands-free operation
- Single roll capacity

**Junior Capacity Dispensers**

- 6 1/8" w x 7 1/4" d x 10 7/8" h



#	color	price
G1669482	gray	
G2627931	blue	

each **\$14.10**

**Junior Capacity Towels**

- 1-ply
- 275 sheets per roll
- 8 pack

#	price
G0882104	<b>\$44.83</b>

**Regular Capacity Dispensers**

- 9 1/4" w x 8 3/4" d x 11 1/2" h



#	color	price
G0870116	gray	
G1333631	blue	

each **\$15.64**

**Regular Capacity Towels**

- 1-ply
- 320 sheets per roll
- 6 pack

#	price
G1651937	<b>\$45.19</b>

**GEORGIA-PACIFIC Paper Towel Dispenser**

- Wall mount, steel dispenser
- Chrome finish
- Holds up to 600 multifold towels or 500 C-fold towels
- 11 1/4" w x 4" d x 11 1/2" h



#	price
G0674572	<b>\$24.42</b>

**GEORGIA-PACIFIC Signature Paper Towels**

- Embossed 2-ply design

#	type	sheets	packs	price
G3074434	c-fold	120	12	<b>\$25.71</b>
G1048004	multifold	125	16	<b>\$24.71</b>



**GOJO Hand Cleaner Dispenser**

- Black plastic dispenser
- 4.5 lb capacity
- Manual dispensing operation
- Wall mount
- 5 1/2" w x 5 1/8" d x 4 1/2" h

#	price
G1751154	<b>\$14.69</b>

**GOJO Pumice Hand Cleaner Soap**

- Helps remove grease, tar, and oil
- Lotion formula
- 4.5 lb refill cartridge
- Lemon fragrance

#	price
G0362092	<b>\$16.09</b>





# JANITORIAL & GROUNDS MAINTENANCE

### SPRAYWAY

#### Aerosol Glass Cleaner

- Ideal for glass, mirrors, chrome, plastic, stainless steel, and other surfaces in the kitchen, living room, patio, bedroom, bathroom, or car

- Floral fragrance
- 19 oz aerosol can

Z#	price
G0509494	<b>\$2.80</b>



### ZEP PROFESSIONAL

#### Aerosol Glass Cleaner

- For use on any surfaces not harmed by water
- Odorless
- 20 oz aerosol can

Z#	price
G0364795	<b>\$4.48</b>



### WINDEX

#### Glass Cleaner Wipes

- For appliances, cabinets, counters, and windows
- Ammonium hydroxide formula
- 7" x 10" sheet size
- 28 cloth wipes per pack
- 12 pack
- **BIODEGRADABLE PRODUCTS INSTITUTE CERTIFIED**

Z#	price
G4573983	<b>\$45.73</b>



### EARTH FRIENDLY PRODUCTS

#### Window Kleener

- Non-synthetic formula
- For use on water safe surfaces: windows, mirrors, counters, fiberglass, and acrylic
- Light vinegar scent
- **EPA STANDARDS**
- **BIOBASED WITH A MIN 73% OF TOTAL WEIGHT OF ORGANIC CARBON AS PER ASTM D6866**

Z#	size	price
G2688436	32 oz	<b>\$3.81</b>
G1607812	1 gal	<b>\$11.63</b>



### WINDEX

#### Glass Cleaner

- Ammonia-D formula
- Contains no phosphates
- For use on windows, mirrors, counters, fiberglass, and acrylic

Z#	size	per pack	price
G1254206	32 oz	12	<b>\$49.90</b>
G1288892	1 gal	1	<b>\$10.00</b>
G4612711	5 gal	1	<b>\$37.70</b>



### TOUGH GUY

#### Telescopic Window Washer Squeegee

- Grey handle with blue/white scrubbing sponge
- Polyethylene frame, powder coated steel handle
- 12" rubber blade
- 56"-90" adjustable handle length

Z#	price
G4375314	<b>\$20.55</b>



### TOUGH GUY

#### Window Washer Squeegee

- Black and silver
- 48" handle
- 10" rubber blade
- includes pole and washer squeegee*

Z#	price
G3889943	<b>\$22.65</b>



### UNGER

#### Green Window Washer Squeegee

- 14" rubber blade
- For use with steel or brass channels
- includes 6" handle*

Z#	price
G0677293	<b>\$27.51</b>



### MALLORY

#### Window Washer Squeegee

- Black plastic handle
- 8" rubber blade
- includes scrubbing sponge and squeegee blade*

Z#	price
G4389402	<b>\$3.56</b>



### MALLORY

#### Squeegee Bucket

- Plastic
- 2 gal capacity
- 7" depth

Z#	price
G4358112	<b>\$5.91</b>

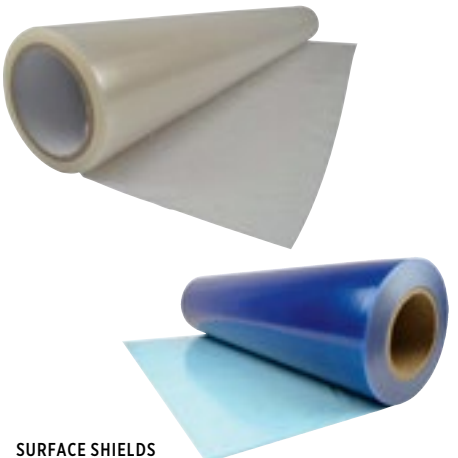

### SURFACE SHIELDS

#### Window Protection Film

- Polyethylene

Z#	color	size	mil thickness	price
G4283684	blue	24" x 600'	1.5	<b>\$54.89</b>
G4283693	clear	36" x 250'	1.5	<b>\$34.92</b>
G4283702	clear	24" x 600'	3	<b>\$99.89</b>

**TOUGH GUY**

**Curved Scratch Brush**

- 7" plastic handle with stainless steel bristles
- Used to clean aluminum and stainless steel materials
- ½" trim (3 x 7 rows)
- 5 pack

# price  
G1897366 **\$21.41**



**TOUGH GUY**

**Truck Wash Brush**

- Green polystyrene bristles
- 10" overall length
- 2½" trim length

# price  
G3239266 **\$26.55**



**TOUGH GUY**

**Counter Brush**

- Horsehair bristles
- 2¼" trim
- 5¼" wood handle
- 8" brush length
- 13¼" overall length

# price  
G0809611 **\$16.52**



**LIBMAN**

**Angled Broom**

- 55" steel handle
- Black bristles consist of stapled polymer fibers
- 15" sweep face

# price  
G4086284 **\$14.63**

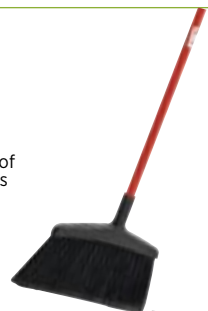

**LIBMAN**

**Broom and Dust Pan**

- 38" steel handle
- 11½" sweep face
- 41" overall length

# price  
G4044363 **\$19.92**



**O'DELL CORPORATION**

**Corn Broom**

- 100% corn fiber bristles
- 55" bamwood handle

# price  
G4174667 **\$19.07**



**RUBBERMAID**

**Hand-Held Dust Pan**

- Polypropylene
- Charcoal
- 8¼" x 12¼"

# price  
G4046926 **\$4.49**



**TOUGH GUY**

**56" Angled Broom**

- 46¾" vinyl coated aluminum handle
- Synthetic bristles with 7½" trim
- 12" sweep face

# price  
G2258401 **\$14.81**



**LIBMAN**

**Push Broom with Handle**

- Multi-surface use
- 24" polypropylene block
- Firm and flexible split tip recycled PET bristles
- 64" overall length
- 3" trim

# price  
G4145811 **\$17.92**



**ABILITY ONE**

**Dust Mop Kit**

- Cotton mop head
- Wire frame attached to 53" wood handle
- Launderable mop head

*includes dust mop, frame and handle*

# price  
G2358456 **\$22.04**



**TOUGH GUY**

**Push Broom**

- Fine-sweeping floor brush
- 3" green flagged synthetic bristles
- 36" hardwood block

# price  
G2355656 **\$44.74**



**TOUGH GUY Threaded Broom Handle**

- Natural wood
- 5' length
- 1" threaded metal tip

# price  
G1139993 **\$8.94**

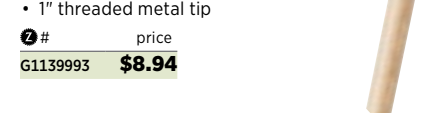

**TOLCO**

**Hand-Held Duster**

- Retractable
- Ostrich feather head
- 14" black plastic handle

# price  
G4241973 **\$13.37**



**UNGER**

**Cobweb Duster**

- Poly fiber head
- Gray
- 11" plastic handle

# price  
G1596725 **\$6.06**



**RUBBERMAID**

**Extended Reach Duster**

- Plastic handle
- Angled head
- 51" length

# price  
G2018003 **\$24.79**



**TOUGH GUY Cut-End Dust Mop**

- Disposable lightweight cotton mop with tie openings
- Fits standard dust mop frames and handles
- 4-ply, 36" x 5"

# price  
G0508286 **\$8.96**

**TOUGH GUY Dust Mop Handle**

- 60" wood handle
- Clip on design

# price  
G0587072 **\$14.39**

**TOUGH GUY Dust Mop Frame**

- Metal frame
- Slide-on connection
- 36" x 5"

# price  
G2209925 **\$8.06**





MORE THAN 800,000 ITEMS ONLINE

# JANITORIAL & GROUNDS MAINTENANCE

## TOUGH GUY

### Steel Mop Bucket and Wringer

- Galvanized steel bucket with wooden rollers
- Hand operated wringer
- 12 qt capacity

Item #	price
G1296163	<b>\$35.93</b>



## ABILITY ONE

### Cut-End Wet Mops

- 8-ply cotton/synthetic blend mop head
- Launderable

Item #	size	price
G3357112	12 oz	<b>\$3.30</b>
G0685623	16 oz	<b>\$5.52</b>
G3418886	20 oz	<b>\$7.01</b>
G2133336	24 oz	<b>\$9.59</b>



## TOUGH GUY Mop Handles

- For use with band top mops
- 60" wood handle

Item #	connection type	price
G2086892	wing nut	<b>\$9.64</b>
G2996497	quick change	<b>\$9.92</b>

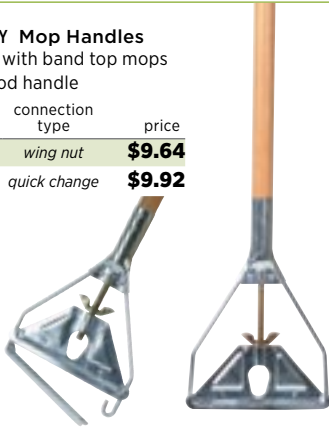

## LIBMAN

### Big Wonder Mop

- Polyurethane synthetic mop with steel handle
- 16" length

Item #	price
G4177311	<b>\$14.93</b>



## RUBBERMAID Sponge Mop

- Roller mop
- Cellulose head with steel handle
- 12" mop head
- 43 1/4" handle length

Item #	price
G1519305	<b>\$27.80</b>



## 3M

### Twist'n Fill Chemical Dispenser

- Dispenses 4 chemicals
- 1 gpm spray fill rate, 3 gpm bucket fill rate
- Wall or cart mount

- ASME/ANSI A112.1.2, ASSE 1055B (2009) STANDARDS

includes brass quick connect hardware, low flow dispense hose, high flow dispense hose and application chart

Item #	price
G2902891	<b>\$34.49</b>

## 3M

### Neutral Floor Cleaner

- 2 L plastic bottle, Twist'n Fill refill
- 6 to 7 pH
- Citrus fragrance

- OSHA AND MATERIAL SAFETY DATA SHEETS STANDARDS

- GREEN SEAL CERTIFIED, VOC LEVELS MEET SCAQM REQUIREMENTS

Item #	price
G2088606	<b>\$34.59</b>



## RUBBERMAID

### Folding Floor Sign

- Caution sign in English, Spanish, and French
- Sign folds with a twist for compact storage
- Nylon
- 20" height
- ANSI STANDARDS

Item #	price
G2033945	<b>\$26.42</b>



## TOUGH GUY

### Bilingual Safety Cone

- "Wet Floor" cone, Spanish and English
- Plastic
- 12 3/4" x 36"

Item #	price
G0289676	<b>\$42.83</b>



See more floor safety signs on page 21

## TOUGH GUY

### Floor Sign

- Convenient folding design
- Text and symbol sign
- Polyethylene
- 12" x 24"

Item #	price
G1885353	<b>\$18.83</b>



## RUBBERMAID

### Tandem Bucket and Wringer Combo

- Polypropylene bucket with metal handle
- Features a hand-operated down-press wringer
- 3" non-marking casters
- 24 oz mop capacity
- 31 qt capacity

Item #	price
G2564493	<b>\$52.26</b>



## DIVERSEY

### Profi Floor Cleaner/Oil and Grease Remover

- Variable dilution
- Surfactant fragrance
- 1 gal jug

Item #	price
G2076907	<b>\$24.14</b>



## BONA

### Pro Series Hardwood Floor Cleaner

- Ready to use
- READILY BIODEGRADABLE PER OECD OR ASTM STANDARDS, GREENGUARD CERTIFIED

Item #	size	price
G0619297	32 oz	<b>\$5.03</b>
G2847555	1 gal	<b>\$16.58</b>



## RUBBERMAID

### WaveBreak Side Press Combo

- Polypropylene
- Baffles reduce wave motion while bucket is transported
- 3" non-marking casters
- 32 oz mop capacity
- 35 qt capacity

Item #	price
G3208974	<b>\$76.30</b>



**SANITAIRE Commercial Upright Vacuum**

- 12" cleaning path
- 5 A, 120 V
- Uses standard filter
- Cloth shake-out bag
- 30' power cord

② # price  
G0741632 **\$114.12**

**SANITAIRE Upright Vacuum Attachment Kit**

*includes dusting brush, upholstery nozzle, crevice tool, (2) extension wands, vinyl hose assembly, curved handle and base adapter*

② # price  
G0922083 **\$28.31**



**NOBLES Portable Carpet Spotter**

- 4" cleaning path, ideal for small stains and soil concentrations
- 115 V, 1.12 HP, 2 stage motor
- 2 gal solution tank, 2 gal recovery tank
- 30 psi pump pressure *includes cart, 8" hose and hand tool*

② # price  
G2955312 **\$748.20**



**DAYTON Walk-Behind Push Sweeper**

- Polyethylene
- 8 gal capacity
- 27" cleaning path
- Side broom sweeps debris into the path of the main broom

② # price  
G1096663 **\$514.60**



**HOOVER PortaPower Lightweight Vacuum Cleaner**

- Commercial portable vacuum
- 7.4 A, 120 V
- Cloth bag, 0.5 gal tank

• ■ **UL, OSHA STANDARDS**  
*includes triple stretch hose, (2) extension wands, shoulder strap, cord storage strap, rug and floor tool, wall floor brush, furniture tool, dusting brush and crevice tool*

② # price  
G4334662 **\$122.33**



**DIVERSEY Carpet Defoamer**

- Removes spots, stains, and odors
- 8.5 to 9 pH
- 1:128 recommended dilution
- 1 qt bottle

② # price  
G0838372 **\$8.02**



**TOUGH GUY Carpet Shampoo**

- Removes spots, spills, stains from carpet and upholstery
- 8.5 pH
- Fruity floral fragrance
- Recommended dilution 1:32 to 1:64
- 1 gal bottle

② # price  
G2148833 **\$16.00**



**HOOVER Bagless Upright Vacuum with Light**

- 15" cleaning path
- 12 A, 120 V
- HEPA filter
- Manual 3-position height adjustment
- ■ **ETL LISTED, UL, OSHA, CRI STANDARDS**

*includes attached transparent triple-stretch hose, extension wand, 17" long crevice tool, dusting brush, and upholstery nozzle*

② # price  
G3532006 **\$205.13**



**ROYAL Bagless Upright Vacuum with Light**

- 15" cleaning path
- 12 A, 120 V
- HEPA filter
- Manual 5-position height adjustment
- ■ **UL, OSHA STANDARDS**

*includes attached stretch hose, extension wand, crevice tool, dusting brush and turbine powered hand tool*

② # price  
G4334705 **\$159.95**



**ORECK Carpet and Upholstery Cleaner**

- Removes grease, oil, and dirt
- Ready to use
- Floral fragrance
- 16 oz bottle

② # price  
G2603097 **\$7.59**



**DAYTON Indoor/Outdoor Vacuum**

- 19" cleaning path
- 6 A, 1.25 peak HP
- 8 gal capacity collection bag
- 12" power cord
- 7" wheels

② # price  
G0871893 **\$180.11**



**EUREKA Cordless 2-in-1 Vacuum**

- 10" cleaning path
- 6 V
- Micron filter
- Removable dirt cup
- 0.5 qt capacity
- ■ **UL LISTED**

*includes charging stand and charger*

② # price  
G4171316 **\$38.05**



**PLASTICOVER Carpet Protection Film**

- Clear LLDPE
- Adhesive coated backing
- 2.5 mil thick
- 36" x 500'

② # price  
G2831227 **\$141.40**





# JANITORIAL & GROUNDS MAINTENANCE



### MILWAUKEE Cordless Wet/Dry Vacuum

- 3 A, 18 VDC, 45 cfm
  - HEPA filter
  - 2 gal tank
  - 6' hose
- includes filter assembly, crevice tool, wide nozzle and vinyl hose*

# price  
G3361486 **\$103.26**

### CRAFTSMAN Commercial Wet/Dry Vacuum

- 11A, 120 V, 6 HP peak, 168 cfm
  - Paper filter
  - 16 gal
  - 12.3 gal wet capacity, 14.8 gal dry capacity
  - ■ UL LISTED
- includes (2) extensions, (3) heads, air filter and 7' hose*

# price  
G4165691 **\$115.54**



### SHOP VAC Right Stuff Wet/Dry Vacuum

- 8.4 A, 120 V, 3 HP peak, 143 cfm
- 6 gal
- Cartridge/collection filter bag
- Polyethylene tank
- 8' hose, 12' power cord
- ■ CUL AND US STANDARDS

*includes high-efficiency collection filter bag, foam sleeve, 8" x 1 1/4" hose, (2) 1 1/4" wands, 10" wet/dry floor nozzle, crevice tool and utility nozzle*

# price  
G4180531 **\$65.61**



### SHOP VAC Cartridge Filter

- For use with 12 gal bag
  - 6 1/2" height
- includes retaining ring*

# price  
G3907285 **\$11.84**



### DAYTON Contractor Wet/Dry Vacuum

- 12A, 120 V, 6.5 HP peak, 210 cfm
- 22 gal
- 14.5 gal wet capacity, 20 gal dry capacity
- ■ CUL AND US STANDARDS

*includes 2 1/2" x 8" lock on hose, two piece plastic extension wand, 14" wet/dry nozzle, 8" utility nozzle, crevice tool, elbow grip, concentrator nozzle and hose holder*

# price  
G2428151 **\$239.87**

### DAYTON Dry Cartridge Filter

- Reusable paper filter
  - 6 1/2" height
  - 7 1/4" OD, 5 3/4" ID
- includes retainer*

# price  
G2073924 **\$13.26**



### DAYTON Industrial Wet/Dry Vacuum Head

- 11A, 120 V, 3 HP peak
- 109 cfm
- Cartridge filter
- ■ CUL AND US STANDARDS

*includes 7" x 1 1/2" hose, utility nozzle with squeegee and (3) vacuum head securing clamps*

# price  
G2852141 **\$311.04**



### MI-T-M 2 HP Electric Cold Water Pressure Washer

- Medium duty
- 1500 psi operating pressure, 2.0 gpm
- 120 V/1-Phase, 17 A AC
- Crankshaft pump with direct drive

*includes solid steel axles and tubed pneumatic tires*

# price  
G1588264 **\$1,250.33**



### MI-T-M 7HP Commercial Cold Water Pressure Washer

- Gas operated, 212 cc MI-T-M OHV Engine
- 3000 psi operating pressure, 2.4 gpm
- Crankshaft pump with direct drive

*includes wand, hose, trigger gun and (4) 0°, 15°, 25° and 40° quick connect nozzles*

# price  
G3239345 **\$973.83**



### A. R. NORTH AMERICA 1.8 HP Electric Cold Water Pressure Washer

- 1900 psi operating pressure, 1.5 gpm
- 120 V/1-Phase, 15 A AC
- 3-piston axial pump with direct drive
- ■ CE/GS/UL STANDARDS

*includes foam dispenser, qc garden hose connection, 0 to 60° variable spray nozzle, turbo lance, grit top and hose reel*

# price  
G1277997 **\$163.56**



### APACHE MILLS Rubber Entrance Mats

- Rectangular outdoor mats
- Black molded rubber, 3/8" thick
- Fingertip pattern with beveled edges
- 1 lb/sq-ft

#	size	price
G3689174	2' x 2' 8"	<b>\$17.20</b>
G3599626	2' 8" x 3' 3"	<b>\$26.28</b>
G3725057	3' x 5'	<b>\$44.11</b>
G3679426	3' x 6'	<b>\$59.24</b>

### NOTRAX Carpeted Entrance Mats

- Rectangular indoor mats, 5/16" thick
- Decalon fiber, tufted cut pile, vinyl backing
- Beveled edges
- 3' x 5'

#	color
G0146632	charcoal
G0146641	dark brown
G0146657	red/black

each **\$35.54**



**FIMCO Spot Sprayers**

- Polyethylene tank
- 12V diaphragm pump
- 15' EPDM rubber hose and 5" opening
- Full length drain sump
- Adjustable cone nozzle

*includes handgun with adjustable tip*

**15 gal Tank Capacity**

- 2.1 gpm
- 60 psi
- 25' vertical spray distance
- 35' horizontal spray distance

#	price
G2224887	<b>\$180.25</b>

**25 gal Tank Capacity**

- 2.1 gpm
- 60 psi
- 25' vertical spray distance
- 35' horizontal spray distance

#	price
G3055647	<b>\$184.81</b>



**25 gal Tank Capacity**

- 1.0 gpm
- 35 psi
- 12' vertical spray distance
- 25' horizontal spray distance

#	price
G0367552	<b>\$128.84</b>



**FIMCO 25 Gallon ATV Sprayer**

- 3.8 gpm and 0 to 45 psi
- 12V diaphragm pump and polyethylene tank
- 15' hose
- 26' vertical spray distance
- 43' horizontal spray distance

#	price
G6103806	<b>\$419.60</b>



**CHAPIN Steel Tank Handheld Sprayers**

- 35 to 45 psi
- 4" fill opening
- Adjustable cone nozzle

**42" Hose**

#	tank	wand	pump	price
G1291954	3.5 gal	18"	12"	<b>\$56.33</b>
G1317626	2 gal	12"	9"	<b>\$118.84</b>

**48" Hose**

#	tank	wand	pump	price
G1873347	3.5 gal	24"	14"	<b>\$87.30</b>

**CHAPIN Industrial 6 Gallon Cart Sprayer**

- Stainless steel tank
  - 35 to 45 psi
  - 120" hose, 18" wand, 14" pump
  - 4" fill opening
- features wheel base push/pull cart*

#	price
G2010233	<b>\$286.86</b>



**FIMCO 3/8" Sprayer Handguns**

- Adjustable pattern tip
- Plastic wand with aluminum extension
- For use with ATV, spot and trailer sprayers

**Economy**

- 29"
- 100 psi

#	price
G0436186	<b>\$6.55</b>

**Heavy Duty**

- 27"
- 300 psi

#	price
G0592347	<b>\$24.51</b>



**CHAPIN Polyethylene Tank Handheld Sprayers**

- 35 to 45 psi
- 34" hose
- 4" fill opening
- Adjustable cone nozzle
- Anti clog filter

#	tank	wand	pump	price
G2838622	1 gal	12"	9"	<b>\$9.42</b>
G3594841	2 gal	18"	12"	<b>\$13.43</b>



**CHAPIN 4 Gallon Backpack Sprayers**

- Polyethylene tank
  - 48" hose
  - 4" fill opening
  - Adjustable cone, fan nozzle
- includes strap*

#	wand	psi	price
G4268074	21"	80	<b>\$49.49</b>
G1766947	18"	—	<b>\$64.89</b>
G2674174	18"	15 to 60	<b>\$88.40</b>



**SOLO HDPE Tank Handheld Sprayer**

- 2 gal tank capacity
  - 45 psi
  - 48" hose, 4 1/2" fill opening
  - 28" wand, 12 1/2" pump
  - Adjustable nozzle
- includes strap and (4) nozzle assortment*

#	price
G4308692	<b>\$30.50</b>





# JANITORIAL & GROUNDS MAINTENANCE



### SWAN 400 PSI Reinforced Rubber Water Hoses

- GHT connection
- 50' hose
- 5/8" inside diameter
- 732 gph

For Use with Hot/Cold Water

Z#	characteristics	price
G1544347	abrasion resistant	<b>\$39.13</b>

For Use with Hot Water

Z#	characteristics	price
G1267944	kink resistant	<b>\$33.53</b>

### SWAN 600 PSI Reinforced Rubber Water Hoses

- GHT connection
- For use with hot/cold water

#### 25' Hose

- 5/8" inside diameter
- 732 gph
- Kink resistant

Z#	price
G2787626	<b>\$17.99</b>



#### 50' Hose

- 3/4" diameter
- 918 gph
- Abrasion resistant

Z#	price
G2928563	<b>\$69.72</b>



### SWAN Reinforced PVC Water Hose

- GHT connection
- 15' hose
- 5/8" inside diameter
- For use with cold water

Z#	price
G0650562	<b>\$5.34</b>



### AMES Wall Mount Molded Polypropylene Hose Reel

- 19" wide
- 18" reel diameter
- Holds 1/2" hose (125'), 5/8" hose (100'), or 3/4" hose (75')

includes 4' leader hose with brass coupling

Z#	price
G3395971	<b>\$29.91</b>



### WESTWARD Recycled Tire Rubber Soaker Water Hose

- GHT connection
- 50' hose
- 5/8" inside diameter
- 30 psi and 732 gph
- For use with cold water

Z#	price
G2072147	<b>\$13.03</b>



### WESTWARD Spiral Reinforced Antibacterial PVC Water Hose

- GHT connection
- 100' hose
- 5/8" inside diameter
- 450 psi and 732 gph
- Abrasion resistant

Z#	price
G1524826	<b>\$44.86</b>



### YARD BUTLER Steel Hose Hanger

- 11" wide reel
- 5 1/2" reel diameter
- Holds 1/2" hose (175'), 5/8" hose (150'), or 3/4" hose (110')
- Heavy duty bracing

Z#	price
G4388045	<b>\$22.81</b>



### LIBERTY Steel Multi Mount Hose Reel

- 9" wide reel
- 15 1/2" reel diameter
- Holds 1/2" hose (225'), 5/8" hose (200'), or 3/4" hose (125')

includes 5' leader hose and instructions

Z#	price
G1274962	<b>\$121.26</b>

### WESTWARD Hose to Pipe Adapters

- Brass



Z#	type	connection
G0911032	double female, swivel	FGHT x 3/4" FNPT
G0401685	double male	3/4" GHT(M) x 3/4" NPT(M) x 1/2" (F)

each **\$4.48**

### WESTWARD Hose to Hose Connectors

- Brass



Z#	type	connection
G1947732	double female, swivel	3/4" GHT(F) X 3/4" GHT(F)
G3359054	double male	3/4" GHT

each **\$4.48**

### WESTWARD Hose Repair Kit

- Brass
- Male/female coupling
- GHT connection
- For use with 5/8" ID garden hose

includes stainless steel worm gear clamps

Z#	price
G2307383	<b>\$9.29</b>



### LIBERTY Portable Steel Hose Carts

- 32" cart height
  - 4 pneumatic wheels
  - 10" wheel diameter
- include 5' leader hose and instructions

#### 14" Wide Reel (Green)

- 17" reel diameter
- Holds 1/2" hose (375'), 5/8" hose (350'), or 3/4" hose (275')

Z#	price
G1902257	<b>\$167.28</b>

#### 14 1/2" Wide Reel (Tan)

- 16 1/2" reel diameter
- Holds 1/2" hose (325'), 5/8" hose (300'), or 3/4" hose (200')

Z#	price
G0655523	<b>\$164.92</b>







**NELSON**  
**Traveling Sprinkler**  
 • Cast iron  
 • 13,500 sq-ft spray coverage  
 • 40 psi  
 • 3/4" cap connection  
 includes shut-off ramp

#	price
G1145392	<b>\$65.92</b>

**NELSON**  
**Outdoor Remote Watering Control**  
 • 100 psi  
 • 3/4" GHT connection  
 • 3" w x 4 1/16" d x 5 1/16" h  
 • Remote control on/off  
 includes 12 V remote battery

#	price
G1285715	<b>\$67.44</b>



**NELSON**  
**Outdoor Dual Outlet Water Timer**  
 • 3/4" GHT connection  
 • 7" w x 2 3/4" d x 8 3/4" h  
 • 6 max on/off cycles  
 • 360 minute max time cycle  
 features manual on/off button  
 and rain delay option

#	price
G4689447	<b>\$36.51</b>



**RAIN BIRD**  
**Brass Impact Sprinkler Head**  
 • 20 to 50 psi  
 • 3.4 to 5.0 gpm  
 • 1/2" mnpt  
 • 17' to 24' throw radius  
 • Adjustable pattern

#	price
G0578225	<b>\$13.15</b>



**EARTHWAY**  
**Handheld Broadcast Spreaders**  
 • 25 lb capacity  
 • Hand crank handle

**1 Hole Drop**  
 • nylon hopper  
 • 8' to 16' spread width  
 includes adjustable  
 shoulder strap

#	price
G1343675	<b>\$30.61</b>



**3 Hole Drop**  
 • Poly hopper  
 • 15' spread width  
 includes rate calculation  
 matrix, rain cover and wide  
 carrying straps

#	price
G4160125	<b>\$79.37</b>



**EARTHWAY Broadcast Spreaders**  
 • Steel frame  
 • 3 hole drop  
 • Pneumatic wheels  
 • For use with grass seed, fertilizer and ice melt

**65lb Capacity**  
 • Polypropylene hopper  
 • 12' spread width  
 • 3 1/2" w, 9" diameter wheels  
 • Loop handle

#	price
G2294092	<b>\$86.29</b>



**80 lb Capacity**  
 • Polyethylene hopper  
 • 12' spread width  
 • 3 1/2" w, 10" diameter wheels  
 • U-bar handle

#	price
G4182491	<b>\$88.19</b>

**100 lb Capacity**  
 • Polyethylene hopper  
 • 12' to 14' spread width  
 • 4" w, 13" diameter wheels  
 • Adjustable T-bar handle

#	price
G0476761	<b>\$150.68</b>



**WESTWARD**  
**Broadcast Spreaders**  
 • 60 lb capacity  
 • Steel frame with polypropylene hopper  
 • Pneumatic 4" w, 10" diameter wheels  
 • 12' spread width  
 • 1 hole drop  
 includes cover

**Steel Axle**  
 • For use with grass  
 seed and fertilizer

#	price
G4337785	<b>\$88.35</b>

**Stainless Steel Axle**  
 • For use with grass seed,  
 fertilizer and salt

#	price
G4337794	<b>\$112.22</b>



**FIMCO ATV Spreader**  
 • 99 lb capacity  
 • 5' to 45' spread width  
 • Stainless steel radial 6-blade fan  
 • 12V motor powered by 12VDC  
 includes motor speed control

#	price
G4048703	<b>\$299.64</b>

**EARTHWAY Tow Behind Spreaders**  
 • Steel frame and hopper  
 • Pin hitch mount  
 • 3 hole drop  
 • Tractor fit  
 • Pneumatic wheels

**80 lb Capacity**  
 • 10' spread width  
 • 3 1/2" w, 10" diameter wheels  
 • Ground drive  
 includes rate calculation matrix

#	price
G3961081	<b>\$94.85</b>



**100 lb Capacity**  
 • 5' to 12' spread width  
 • 4" w, 13" diameter wheels  
 • Tractor tow behind  
 includes hopper debris screen

#	price
G2822172	<b>\$190.74</b>



**TRUE TEMPER**  
**Wheelbarrow Tires**  
 • Rubber skinned foamed rubber  
 • 16" outside, 8" tire rim diameter  
 • 3 3/4" wide  
 • 4" thick  
 • Fits universal 6" ball bearing hub

#	tread	price
G1838146	knobby	each <b>\$66.66</b>
G1204472	ribbed	



**WESTWARD**  
**Wheelbarrows**  
 • 16" wheel diameter  
 • 5/8" axle diameter

**Seamless Steel Tray**  
 • 6 cu-ft capacity  
 • 1 flat free poly wheel  
 • 4" wide wheel

#	price
G3187362	<b>\$132.18</b>



**Polyethylene Tray**  
 • 10 cu-ft capacity  
 • 2 pneumatic rubber wheels  
 • 3 1/2" wide wheels

#	price
G1124155	<b>\$173.68</b>





# JANITORIAL & GROUNDS MAINTENANCE

MORE THAN 800,000 ITEMS ONLINE

### WESTWARD Scoops

- #12 blade
- D-grip handle

#### Grain Scoops

Z#	blade material	blade size	handle	price
G2375177	poly	14½" x 18"	27"	<b>\$28.47</b>
G2303682	aluminum	14¾" x 18¾"	29½"	<b>\$56.77</b>

#### 16 Gauge Western Scoop

Z#	blade material	blade size	handle	price
G1000867	steel	14½" x 19"	27"	<b>\$48.89</b>



### WESTWARD

#### 14 Gauge Square Point Shovel

- 9¾" x 11¾" steel blade
- 48" straight handle

Z#	price
G1416502	<b>\$31.21</b>



### NUPLA

#### 16 Gauge Square Point Shovel

- 10" x 11½" steel blade
- 48" straight ergonomic handle

Z#	price
G1609185	<b>\$28.31</b>



### WESTWARD

#### 14 Gauge Round Point Shovels

- Steel blade
- 48" straight handle

Z#	blade size	price
G0389216	8½" x 11½"	<b>\$32.08</b>
G1434544	9" x 11"	<b>\$36.06</b>



### TRUE TEMPER

#### 14 Gauge Ceremonial Round Point Shovel

- 9" x 11½" steel blade
- 27" D-grip handle

Z#	price
G1013801	<b>\$91.19</b>



### GERBER

#### Folding Spade

- 6" x 8½" boron steel blade
- 25½" D-grip handle
- Serrated edge

Z#	price
G0463102	<b>\$41.80</b>



### WESTWARD

#### 14 Gauge Drain Spade

- 6" x 14" steel blade
- 27" D-grip ergonomic handle

Z#	price
G1861413	<b>\$44.11</b>



### FISKARS

#### Stand-Up Weed Remover

- 4" stainless steel blade
- 39" straight handle
- Serrated claws

Z#	price
G3736792	<b>\$41.08</b>



### MALLORY

#### Telescopic Snow Shovel

- 13" x 9" plastic blade
- Telescoping aluminum handle
- 30" to 40" handle length

Z#	price
G3037431	<b>\$9.68</b>



### UNION TOOLS

#### Snow Pusher

- 30" x 11" poly blade
- 42" D-grip handle

Z#	price
G1122904	<b>\$24.99</b>



**VALUE BRAND**  
**Recycled Rubber Mulch Roll**

- 2' x 6'
- ½" thick
- Brown

**#** # price  
G4768662 **\$15.25**



**BIRD-X**  
**3-D Fox Decoy**

- Poly Rubber
- 6.5" w x 30" l x 18.5" h
- 2 lb

**#** # price  
G4284813 **\$42.85**



**VALUE BRAND**  
**Recycled Rubber Mulch Tree Ring**

- 24" diameter
- ½" thick
- Brown/red

**#** # price  
G4769317 **\$13.67**

**DIVERSEY**  
**14 oz Wasp and Hornet Killer**

- No CFC
- Ready to use
- ■ EPA STANDARDS

**#** # price  
G2565674 **\$5.44**



**CRC**  
**14 oz Wasp and Hornet Killer**

- Carbon dioxide
- Ready to use
- ■ EPA STANDARDS

**#** # price  
G1219285 **\$4.12**



**JT EATON**  
**Boric Acid Insecticidal Powder**

- Ready to use
- Kills crawling insects, roaches, ants, palmetto bugs and silverfish

**#** # size price  
G1992654 16 oz **\$3.14**  
G3233702 5 lb **\$18.73**



**TOMCAT**  
**Rodenticide Chunks**

- Bromethalin
- 4 lb pail
- includes (64) 1 oz chunks

**#** # price  
G4360325 **\$26.51**



**OFF**  
**6 oz Aerosol Insect Repellent**

- 25% DEET
- Ready to use
- Up to 6 hours of protection from mosquitoes, flies, ticks, chiggers and fleas
- ■ EPA STANDARDS

**#** # price  
G3490943 **\$6.05**



**P.F. HARRIS**  
**128 oz Bed Bug Spray**

- Trigger spray
- Ready to use
- For use against bed bugs and lice

**#** # price  
G1603761 **\$25.26**



**CATCHMASTER** Fly Traps

- 3" w x 7" l x 9" h
- Poly plastic and adhesive
- 4 pack

**#** # price  
G3297804 **\$1.59**



**CATCHMASTER**  
**Disposable Glue Traps**

- Bait box
- 5¼" x 8½"
- Plastic and adhesive
- 4 pack

**#** # price  
G2804672 **\$2.38**



**CATCHMASTER**  
**Disposable Glue Trap**

- Bait box
- 3½" x 7"
- Plastic and adhesive

**#** # price  
G4143334 **\$0.45**



**TOMCAT**  
**Snap Style Mouse Trap**

- Plastic
- 1¾" w x 3" l x 1¼" h
- 0.05 lb
- 1 mouse capacity

**#** # price  
G1650257 **\$3.36**





# JANITORIAL & GROUNDS MAINTENANCE

MORE THAN 800,000 ITEMS ONLINE



### ALLEGRO Deluxe Vinyl Umbrella

- 92" overall height
- 84" diameter
- 6" collapsed width
- Steel frame
- Metal pole with tilt

**Z#** price  
**G2249161 \$239.75**

### KAMP-RITE TENT COT INC Polyester Double Tent Cot with Rain Fly

- 8" w x 54" l x 34" h folded
- 52" w x 84" l x 40" h opened
- 11" h platform
- 550 lb capacity
- 2 windows

**Z#** price  
**G1852234 \$269.63**



### VALUE BRAND Instant Canopy

- Steel frame with polyester cover
  - 10' x 10'
  - 7' to 8' center height
  - 6'4" to 7' side height
- includes roller bag and anchor kit*

**Z#** price  
**G2700397 \$124.99**



### VALUE BRAND Polyester Manhole Utility Shelters

- Blower duct tube opening
- includes storage bag and stakes*

#### Economy Tent

- 31" w x 31" l x 4" h collapsed
- 72" w x 72" l x 84" h opened
- Fiberglass frame
- 2 windows
- Spring open design

**Z#** price  
**G4274575 \$280.09**

#### Deluxe Tent

- 7" w x 7" l x 39" h collapsed
- 72" w x 72" l x 85" h opened
- Steel frame
- Easy set-up frame design

**Z#** price  
**G4265362 \$391.94**



### KAMP-RITE TENT COT INC Polyester Economy Cot

- 2" w x 27" l x 8" h folded
- 24" w x 75" l x 7 1/2" h opened
- 250 lb capacity

**Z#** price  
**G4723153 \$31.72**



### VALUE BRAND Storage Shed

- Steel frame with polyethylene cover
- 8' x 12'
- 7' 8" center height
- 6'1" side height

*includes frame, roof cover, endwalls, bungees, (6) foot plates and (6) stakes*

**Z#** price  
**G4262465 \$209.99**



### VALUE BRAND Heavy Duty Shelter

- Steel frame with polyethylene cover
- 10' 8" x 20'
- 10' center height
- 6' 8" side height
- 9' x 7' 8" door

*includes frame, roof cover, sidewalls, bungees, (8) foot plates, (8) stakes and reinforced wire*

**Z#** price  
**G4271111 \$324.99**



### KAMP-RITE TENT COT INC Polyester Kwik Cot

- 9" w x 42" l x 8" h folded
- 33" w x 84" l x 18" h opened
- 400 lb capacity

**Z#** price  
**G4732987 \$79.85**



### VALUE BRAND U-Channel Fence Posts

- Steel with PVC coating
- 14 gauge
- 3/4" diameter
- 0.47 weight/ft
- Green

**Z#** size price  
**G2564843 1 1/2" x 72" \$4.29**  
**G2088265 4 1/2" x 60" \$3.59**  
**G2477377 4 1/2" x 48" \$2.89**  
**G3349981 4 1/2" x 36" \$2.29**



**GATORADE**  
Thirst Quencher Drink Mixes

**Powder**

- 21 oz
- Yields 2½ gal

#	flavor
G2537622	orange
G1146494	riptide rush
G3109687	fruit punch
G1212592	glacier freeze
G3126514	lemon-lime

each **\$3.66**



**Liquid Concentrate**

- 1 gal
- Yields 6 gal

#	flavor
G2087285	fierce grape
G2261691	fruit punch
G1590041	orange
G3276847	lemon-lime

each **\$10.34**



**SQWINCHER**  
Freezer Pops

- Liquid
- 3 oz
- Assorted flavors
- 150 pack

#	price
G0284304	<b>\$33.70</b>



**IGLOO**  
Beverage Cooler

- 10 gal capacity
- Ultratherm foam insulation
- features cup dispenser bracket and stain and odor resistant liner

#	price
G1394784	<b>\$58.31</b>



**COLEMAN**  
Wheeled Chest Cooler

- Thermozone insulation
- 50 qt capacity
- 14" w x 26" l x 16½" h

#	price
G1037881	<b>\$37.03</b>



**THERMOS**  
BPA Free Hydration Bottles

- 24 oz capacity
- Leak-proof lid with rotating meter
- Eastman tritan copolyester

#	color
G4393182	blue
G4393216	purple
G4393191	smoke
G4393234	pink
G4393207	red

each **\$7.83**



**CAMELBAK**  
Hydration Packs

- Nylon pack with thermoplastic polyurethane film reservoir
- Quick release shoulder straps

#	capacity	dimensions	price
G4583065	50 oz/1.5 L	7" w x 2¾" d x 11" l	<b>\$35.62</b>
G4519907	100 oz/3 L	7" w x 3" d x 17¼" l	<b>\$78.83</b>

**IGLOO**  
Thermoelectric Iceless Personal Cooler

- EPS foam insulation
- 28 qt capacity
- 13¼" w x 18⅞" l x 17½" h
- Fits in 12V outlets
- includes 12 V adapter

#	price
G4293326	<b>\$79.80</b>



**BUBBA**  
Keg Water Mug

- 52 oz capacity
- Stainless steel and polypropylene
- Dual-wall foam insulation
- Sure Fit snap lid
- Carry handle with bottle opener

#	price
G4453863	<b>\$12.61</b>



**IGLOO**  
Stainless Steel Chest Cooler

- Ultratherm foam insulated body
- 54 qt capacity
- 15⅞" w x 24¼" l x 16½" h
- Elevated non-metallic base

#	price
G4293292	<b>\$126.64</b>

**IGLOO Industrial Beverage Coolers**

- Ultratherm foam insulation

Polyethylene Coolers				
#	capacity	ext. dia	height	price
G2454611	2 gal	11½"	14¾"	<b>\$24.24</b>
G1713643	3 gal	13½"	14"	<b>\$27.92</b>
Plastic Coolers				
#	capacity	ext. dia	height	price
G0881991	5 gal	13"	20½"	<b>\$36.37</b>
G1901261	10 gal	15½"	23¼"	<b>\$63.05</b>





# JANITORIAL & GROUNDS MAINTENANCE

## RUST-OLEUM

### High Performance Enamel Aerosols

- Solvent based
- 15 oz net weight
- 1 to 2 hr dry time
- For use on steel and metal
- 14 sq-ft coverage
- For interior and exterior use
- ■ VOC, MIR STANDARDS

#### Primers

- Flat finish

Z# color

G2563303 red

G0953784 gray

each **\$5.96**



#### High Temperature Finishes

- Resists temperatures up to 1000°F
- Flat finish

Z# color

G1439261 black

G2040455 aluminum

each **\$5.96**



#### Standard Finishes

Z# color finish

G2238397 safety yellow gloss

G0697952 safety blue gloss

G1906974 black flat

G1509076 white gloss

G2820221 light machine gray gloss

each **\$6.05**



### RUST-OLEUM GlowMax Sprays

- Solvent based enamel
- 15 oz net weight
- 4 hr dry time
- 9 to 12 sq-ft coverage
- ■ VOC, MIR STANDARDS

Z# color

G2242861 green

G2585186 safety yellow

each **\$22.97**



### RUST-OLEUM Galvanized Spray Paint

- Solvent based epoxy ester
- 14 oz net weight
- Zinc galvanized
- 1 hr dry time with up to 22 sq-ft coverage
- ■ VOC, MIR STANDARDS

Z# price

G1270701 **\$4.69**



## RUST-OLEUM

### Industrial Choice Inverted Marking Paints

- Precision line spray tip
- 17 oz net weight
- 1 to 2 hr dry time
- 600 to 700 linear ft/1" strip coverage
- ■ VOC, MIR STANDARDS

#### M1600 System

- Solvent based
- Markings last 3 to 6 months when undisturbed

Z# color

G3269357 fluorescent orange

G1972101 white

G1129877 caution blue

G2941626 safety green

each **\$3.55**



#### M1800 System

- Water based
- Markings last 1 to 3 months when undisturbed

Z# color

G1558523 white

G2881173 fluorescent pink

each **\$4.00**



## RUST-OLEUM

### Industrial Choice MC1800 System Inverted Marking Chalks

- Water based
- 17 oz net weight
- 1 hr dry time
- 500 to 530 liner ft/1 1/4" strip coverage
- For temporary marking that lasts up to 30 days

Z# color

G1524442 white

G1578123 blue

each **\$5.50**



## RUST-OLEUM

### High Performance 2300 System Inverted Striping Paints

- Solvent based
- 18 oz can
- 1/2 hr dry time
- 300 linear ft/4" strip coverage
- For use on pavement, concrete, grass and metal
- ■ VOC, MIR STANDARDS

Z# color

G0934403 yellow

G2890876 white

each **\$7.80**



## RUST-OLEUM

### Industrial Choice AF1600 System Athletic Field Inverted Striping Paint

- Water based
- 17 oz can
- 1/2 hr dry time
- 100 to 200 linear ft/4" strip coverage
- ■ VOC, MIR STANDARDS

Z# color price

G3248262 white **\$4.35**



## RUST-OLEUM

### Industrial Choice S1600 System Inverted Striping Paints

- Water based
- 18 oz can
- 1/2 hr dry time
- 150 linear ft/4" strip coverage
- For use on pavement, concrete, grass and metal
- ■ MIR STANDARDS

Z# color

G1723741 yellow

G1870531 white

each **\$4.19**



### RUST-OLEUM Rust Reformers

- 1 gal bottle
- 1 hr dry time
- 590 to 1,175 sq-ft/gal coverage
- For use on rusted steel
- Less than 45 g/L VOC

Z# color price

G2671891 clear **\$75.40**

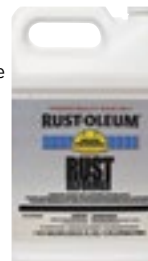

### RUST-OLEUM Striping Machine

- Steel/plastic
- 32" overall length
- Holds 1 can of marking paint or chalk

Z# price

G2509832 **\$97.25**



### RUST-OLEUM Cold Galvanizing Compounds

- Solvent based enamel
- 1 to 2 hr dry time
- 310 to 440 sq-ft/gal coverage
- For interior and exterior use
- Less than 36 g/L VOC

Z# size price

G1763343 1 gal can **\$119.64**

G2453762 1 qt can **\$33.00**



**RUST-OLEUM Epoxyshield Professional Floor Coating Kit**

- Solvent based epoxy
- 2 gal
- 16 to 72 hr dry time
- 300 to 400 sq-ft coverage
- Less than 250 g/L VOC content

#	color	finish
G0528367	silver gray	semi-gloss
G1936925	dark gray	semi-gloss
G1263936	dunes tan	semi-gloss
G1407253	clear	high gloss
G0672287	tile red	semi-gloss

each **\$95.66**



**SUREBOND Joint Stabilizing Sealers**

- Water based epoxy
- 1 gal
- 24 hr dry time
- 100 to 300 sq-ft/gal coverage
- Less than 100 g/L VOC
- ■ EPA, VOC STANDARDS

#	finish
G2418306	matte to satin
G0584902	semi-gloss

each **\$44.17**



**RUST-OLEUM Epoxyshield Blacktop Coatings**

- Solvent based acrylic
- 2 gal
- 4 hr dry time
- 600 to 800 sq-ft/gal coverage
- 46 g/L VOC content

#	price
G3665934	<b>\$49.16</b>



**SPECIALTY Tub and Tile Refreshing Kit**

- Solvent based epoxy acrylic
- 1 qt
- Gloss finish
- 559 g/L VOC content

*includes base and activator*

#	color	dry time
G4358356	white	1 to 2 hr
G3893486	biscuit	18 hr
G4131827	almond	18 hr

each **\$24.25**



**RUST-OLEUM Coal Tar Epoxy C9578 System**

- 18 to 36 hr dry time
- Less than 250 g/L VOC content

**Coal Tar Epoxy Coating**

- Oil based
- 100 to 130 sq-ft/gal coverage
- Black matte

#	size	price
G2454112	1 gal	<b>\$55.08</b>

**Coal Tar Epoxy Activator**

#	size	price
G2564256	1 qt	<b>\$16.45</b>



**RUST-OLEUM Marine Paints**

- Alkyd resin
- 1 qt
- 100 sq-ft/gal coverage
- VOC free

**Topside Paints**

- Gloss finish
- 4 to 7 hr dry time

#	color
G1364605	white
G2908981	battleship gray
G3131186	navy blue

each **\$12.95**



**Boat Bottom Paints**

- Flat finish
- 24 hr dry time

#	color
G1407944	black
G3393643	blue

each **\$31.89**



**SUNNYSIDE Solvents**

- Fuel based denatured alcohol
- VOC content exempt

#	size	price
G4408887	1 qt	<b>\$2.89</b>



**SUNNYSIDE Lacquer Thinner**

- Solvent based
- 1 gal
- 334 g/L VOC content

#	price
G2281693	<b>\$9.99</b>



**SUNNYSIDE Mineral Spirit**

- Solvent based
- 1 gal
- Low odor
- Less than 772 g/L VOC content

#	price
G2783322	<b>\$9.92</b>



**RUST-OLEUM Automotive Paints**

- 1 qt
- ½ hr dry time

#	color	finish	VOC content
G3558326	clear	gloss	395 g/L
G3519896	jet black	satn	388 g/L

each **\$21.89**



**RUST-OLEUM Automotive Primers**

- 12 oz net weight
- Flat finish
- ■ VOC, MIR STANDARDS

#	color	dry time	coverage	price
G0960601	gray	1 hr	8 sq-ft	<b>\$4.60</b>
G3131974	dark green	30 min	10 to 15 sq-ft	<b>\$4.64</b>





# JANITORIAL & GROUNDS MAINTENANCE

## ACCUFORM SIGNS Wet Paint Sign Pad

- Plastic
- White and red
- 14" x 10"
- 25 pack

See all signs  
on pages  
36-41

Z#	price
G5215007	<b>\$82.77</b>



## VALUE BRAND Heavy Duty Extension Poles

- Aluminum inner pole with fiberglass outer pole
- Universal thread
- Yellow

Z#	length	price
G0978162	8' to 16'	<b>\$34.99</b>
G0556543	6' to 12'	<b>\$29.29</b>



## WOOSTER Painting Extension Pole

- Aluminum inner pole with fiberglass outer pole
- Universal thread
- 4' to 8'
- Silver/black

Z#	price
G0668656	<b>\$22.06</b>



## 3M PREFERRED CONVERTER Masking Tapes

### Crepe Paper, Blue

- Synthetic rubber adhesive
- 1/8" x 60 yd
- 5 mil thickness
- 24 lb/in tensile strength

Z#	price
G4204751	<b>\$1.92</b>

### Crepe Paper, Green

- Rubber adhesive
- 1/4" x 60 yd
- 6.7 mil thickness
- 25 lb/in tensile strength

Z#	price
G3942093	<b>\$1.82</b>



## ENCORE PLASTICS Mix and Measure Container

- Solvent-resistant plastic
- 8 1/2" x 6 7/16"
- 5 qt

includes ounce and metric measures

Z#	price
G1304746	<b>\$2.01</b>



## PREMIER Cage Style Paint Roller Frame

- Steel shank with plastic handle
- Chrome plated
- 12" overall length
- 4" roller length
- 1/4" shank wire

Z#	price
G0733774	<b>\$1.22</b>



## PREMIER Paint Roller Covers

- Polypropylene core with polyester cover
- 3/8" nap
- For use with water and oil based paints
- For use on semi-smooth surfaces

Z#	length	pack	price
G2135883	9"	6	<b>\$7.60</b>
G0896795	9"	2	<b>\$1.97</b>
G1760114	4"	1	<b>\$0.90</b>

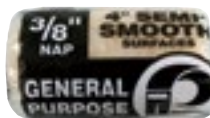

## VALUE BRAND Refill Roller

- Polypropylene core with synthetic cover
- 4" length
- 3/8" nap
- For use on smooth to medium surfaces

Z#	price
G1951932	<b>\$1.67</b>



## PREMIER Mini Paint Roller Frames

- Steel shank and plastic handle
- Chrome plating
- 1/4" shank wire

Z#	roller length	overall length	price
G2725362	4"	12"	<b>\$2.13</b>
G3443964	6 1/2"	14"	<b>\$2.33</b>



## PREMIER Mini Paint Roller Covers

- Plastic core
- 4" long
- 1/2" nap
- For use with water and oil based paints
- For use on semi-smooth to semi-rough surfaces
- 10 pack

Z#	price
G1562626	<b>\$8.71</b>



## PREMIER Foam Cover Mini Paint Roller Covers

- Plastic core
- 4" long
- For use with water and oil based paints
- For use on smooth surfaces
- 10 pack

Z#	price
G0992302	<b>\$12.78</b>



## SHUR-LINE Mini Roller Refills

- Knit fabric with PTFE coating
- 4" length
- 3/8" nap
- For use with latex paints
- 2 pack

Z#	price
G3681221	<b>\$2.94</b>





**IDEALFOLD Cheesecloth**

- 4 ply cotton
- White
- For use with paints, stains, cleansers and polishers

Q #	grade	size	price
G2630223	10	36" x 80 yd	<b>\$37.44</b>
G2789044	40	36" x 70 yd	<b>\$49.82</b>
G0595725	50	36" x 70 yd	<b>\$53.53</b>



**SHUR-LINE**

**9 Piece Paint Tray Set**

- 3/8" (9" cover) and 7/16" (3" cover) naps
- includes (2) 9" roller covers, 9" roller frame, (2) 3" roller covers, 3" roller frame, 2" angle sash paint brush, paint tray liner and plastic paint tray

Q #	price
G3669662	<b>\$8.71</b>



**WOOSTER Paint Tray and Liner**

- 1 qt
- 11" w x 2 1/2" d x 1 1/2" h

Q #	item	material	price
G2385117	paint tray liner	PET	<b>\$0.75</b>
G1850116	paint tray	steel	<b>\$2.77</b>



**VALUE BRAND**

**Bent Radiator Brush**

- Bristle mixed filament brush
- Size 2"
- 2 3/16" brush length, 19 3/4" overall length
- 3/16" thick
- For use with water and oil based paints

Q #	price
G1554454	<b>\$7.48</b>



**VALUE BRAND**

**Angle Sash Paint Brush**

- Polyester brush
- Size 1 1/2"
- 2 1/16" brush length, 11 1/2" overall length
- 3/16" thick
- For use with water and oil based paints

Q #	price
G2361861	<b>\$1.99</b>



**WOOSTER 3 Piece Paint Roller Kit**

- For use on smooth and medium surfaces
- For use with flat paints, stains and waterproofing

includes (1) 9" roller cover, (1) 9" cage roller frame and (1) metal tray

Q #	price
G3478964	<b>\$10.99</b>



**VALUE BRAND Dropcloths**

- Canvas
- Off white

Q #	size	price
G1777526	4' x 15'	<b>\$14.99</b>
G2450034	9' x 12'	<b>\$17.45</b>
G1940285	12' x 15'	<b>\$49.72</b>



**VALUE BRAND**

**Flat Sash Paint Brushes**

- China bristle brush
- 1 1/2" brush length, 7 1/4" overall length
- 3/16" thick
- For use with water and oil based paints

Q #	size	pack	price
G3167893	1"	36	<b>\$14.38</b>
G2577635	2"	24	<b>\$15.71</b>



**WOOSTER Paint Pail and Liner**

- 1 qt
- 7" w x 8 1/2" l x 6 1/2" h

Q #	item	material	pack	price
G0331956	paint pail liner	PET	3	<b>\$3.70</b>
G0903752	paint pail	polypropylene	1	<b>\$12.53</b>



**VALUE BRAND Flat Sash Paint Brush**

- Polyester brush
- Size 2"
- 2 1/16" brush length, 9 1/2" overall length
- 3/16" thick
- For use with water and oil based paints

Q #	price
G0540951	<b>\$1.88</b>



**VALUE BRAND**

**3 Piece Paint Brush Set**

- Foam brushes
- 2 5/8" brush length, 8" overall length
- 3/16" thick
- For use with water and oil based paints

Q #	price
G1564902	<b>\$1.60</b>





# JANITORIAL & GROUNDS MAINTENANCE

MORE THAN 800,000 ITEMS ONLINE

## DEVILBISS HVLP Gravity Spray Gun

- 16.0 cfm @ 30 psi air consumption with ¼" air inlet
- 0.070"/1.8 mm nozzle, 12" pattern
- 1 qt cup capacity
- Medium fluid delivery speed

includes EXL gun, 1 L aluminum cup and 1.8 mm fluid tip

<b>Z</b> #	price
G1012821	<b>\$553.64</b>



## BINKS HVLP Pressure Spray Gun

- 12.0 cfm @ 45 psi air consumption with ¼" air inlet
- 0.042"/1.1 mm nozzle, 12" pattern
- Medium fluid delivery speed

includes 1.4 mm, 1.1 mm, 1.8 mm fluid tip and 930 air cap

<b>Z</b> #	price
G2061595	<b>\$220.49</b>



## SPEEDAIRE Pressure Spray Gun

- 9.3 cfm @ 40 psi air consumption with ¼" air inlet
- 0.047"/1.2 mm nozzle, 10" pattern
- Medium to fast fluid delivery speed

<b>Z</b> #	price
G2333475	<b>\$71.88</b>



## BINKS Suction/Pressure Spray Gun

- 5.0 cfm @ 50 psi air consumption with ¼" air inlet
- 0.070"/1.8 mm nozzle, 9" pattern
- Medium fluid delivery speed

<b>Z</b> #	price
G2221265	<b>\$301.49</b>



## GRACO Air-Assisted Airless Paint Sprayer

- ¾ HP, 115 VAC, 15 A
- 3300 psi, 0.47 gpm flow rate
- 25" w x 22" l x 28" h
- Max hose length 200', max tip size 0.021"

includes metal gun, hose and tips

<b>Z</b> #	price
G3314421	<b>\$2,643.30</b>



## BINKS Siphon Spray Gun

- 14.0 cfm @ 50 psi air consumption with ¼" air inlet
- 0.128"/3.3 mm nozzle
- Fast fluid delivery speed

includes siphon hose

<b>Z</b> #	price
G2753283	<b>\$121.35</b>



## BINKS Siphon Spray Guns

- 0.070"/1.8 mm nozzle
- 1 qt cup capacity
- Medium fluid delivery speed
- Low to medium paint viscosity range

**11" Pattern**  
 • 12.0 cfm @ 40 psi air consumption with ¼" air inlet

<b>Z</b> #	price
G3133864	<b>\$253.29</b>

**10.5" Pattern**  
 • 12.1 cfm @ 50 psi air consumption with ¼" air inlet

<b>Z</b> #	price
G0763567	<b>\$373.09</b>



## CAMPBELL HAUSFELD Airless Paint Sprayer

- ¾ HP, 115 VAC, 8 A
- 3000 psi, 0.34 gpm flow rate
- 20½" w x 24½" l x 25" h
- Max hose length 150', max tip size 0.017"

includes spray gun, 0.15" tip and 25' high pressure hose

<b>Z</b> #	price
G0869416	<b>\$463.04</b>



## DEVILBISS Gravity Spray Gun

- 10.4 cfm @ 40 psi air consumption with ¼" air inlet
- 0.059"/1.5 mm nozzle, 12" pattern
- 24 oz cup capacity
- Medium fluid delivery speed

includes adapter

<b>Z</b> #	price
G4199894	<b>\$178.07</b>



**HYDE**  
**Telescoping Extension Poles**

- Anodized aluminum
- For use with airless spray guns

Q #	length	price
G3383423	5½' to 8½'	<b>\$179.91</b>
G3052262	7½' to 12'	<b>\$183.05</b>

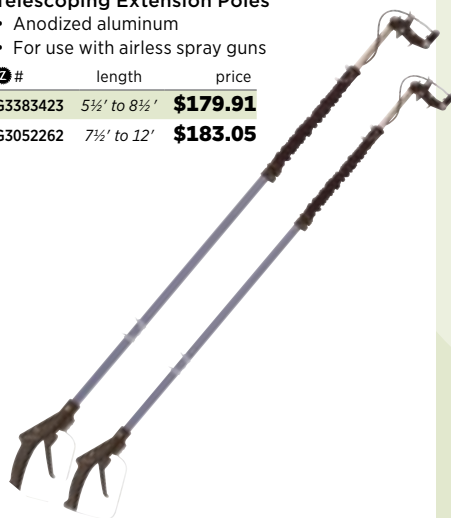

**BINKS HVLP Gravity Spray Gun Kit**

- 12.0 cfm @ 30 psi air consumption with ¼" air inlet
  - 0.051"/1.3 mm nozzle, 10" pattern
  - 1 qt 8 oz cup capacity
  - Medium fluid delivery speed
- includes (2) HVLP gravity guns, 1.0, 1.3 & 1.8 mm fluid nozzle and needles, wrench, cleaning brush set, air adjusting valve with gauge, fluid filter, (2) cups and molded case*

Q #	price
G1026715	<b>\$196.49</b>



**SPEEDAIRE**  
**Siphon Spray Gun**

- 4.4 cfm @ 40 psi air consumption with ¼" air inlet
- 0.070"/1.8 mm nozzle, 10" pattern
- 1 qt cup capacity
- Medium fluid delivery speed

Q #	price
G1904034	<b>\$142.14</b>



**DEVILBISS**  
**Spray Gun Cup Liner**

- 1 qt capacity
- For use with gravity feed cups

Q #	price
G0242024	<b>\$41.00</b>



**CAMPBELL HAUSFELD**  
**Airless Spray Gun Kit**

- Aluminum and steel
  - 0.015" reversible nozzle
  - 3000 psi and ¼" inlet
- includes spray gun, 25' hose, tip and 100 mesh filter*

Q #	price
G0872252	<b>\$132.29</b>

**BINKS**  
**Tank Liners**

- 2.8 gal capacity
- For use with pressure feed tanks

Q #	pack	price
G0491985	10	<b>\$41.16</b>
G0715294	60	<b>\$155.70</b>



**DEVILBISS**  
**Spray Gun Cleaning Kit**

- For use with all spray guns
- includes brushes, pick tool and cleaning wires*

Q #	price
G3084182	<b>\$44.06</b>



**VALUE BRAND** Inert Gas  
**Preservation Spray**

- 0.41 oz
- For use with varnishes, stains, paints, polyurethanes, catalysts, glues and inks

Q #	price
G0888587	<b>\$10.19</b>



**BINKS**  
**Siphon Spray Gun Cup**

- 1 qt capacity
  - Clamp lid
- includes cover with locking lever assembly*

Q #	price
G1409703	<b>\$61.97</b>





# MATERIAL HANDLING



## TOP BRANDS



### BINS

pg 189



### CABINETS

pg 192



### SHELVING

pg 194

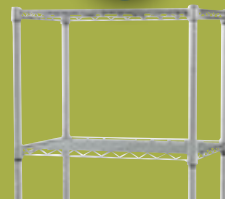

### LADDERS

pg 196



### UTILITY CARTS

pg 198



### TILT TRUCKS

pg 199



### CASTERS

pg 202



### SPEED BUMPS

pg 205



### PULLEYS

pg 206



### WINCHES

pg 209





**AKRO-MILS**

**Stack and Hang Bins**

- Industrial grade polymer
- Reinforced rib
- Molded slot for labels
- Dividers and lids sold separately
- ► MORE SIZES AND COLORS ONLINE

#	blue	red	yellow	green	dimensions	price
G2068762		G0488266	G1299943	G1929295	4 1/4" w x 5 3/4" l x 3" h	<b>\$0.87</b>
G3118674		G1026347	G0441025	G3445906	4 3/4" w x 7 3/4" l x 3" h	<b>\$1.42</b>
G1873295		G2568011	G2713794	G2198804	5 1/2" w x 10 1/2" l x 5" h	<b>\$3.96</b>
G2297522		G2828944	G2015544	G1786556	5 1/2" w x 14 3/4" l x 5" h	<b>\$5.50</b>
G1123087		G2382405	G2430111	G2244961	8 3/4" w x 10 3/4" l x 7" h	<b>\$7.16</b>
G2515545		G3328656	G2394734	G0291575	8 3/4" w x 14 3/4" l x 7" h	<b>\$7.71</b>
G1575253		G1735386	G2193021	G1689956	16 1/2" w x 14 3/4" l x 7" h	<b>\$10.13</b>



**QUANTUM STORAGE SYSTEMS**

**ESD Conductive Bins**

- Stackable
- Less than 105 ohms/sq surface resistivity
- Black
- 100% RECYCLED CONTENT
- ► MORE ONLINE

#	dimensions	price
G3477564	10 3/4" l x 8 3/4" w x 7" h	<b>\$25.15</b>
G2945074	10" l x 5 1/2" w x 5" h	<b>\$10.99</b>
G3508513	10" l x 11" w x 5" h	<b>\$14.41</b>
G1747934	14" l x 16 1/2" w x 0 7" h	<b>\$49.87</b>



**AKRO-MILS Shelf Bins**

- Industrial grade polymer
- Dividers and lids sold separately
- ► MORE SIZES AND COLORS ONLINE

#	blue	red	dimensions	price
G0623296		G3130355	4 3/4" w x 11 1/2" l x 4" h	<b>\$1.47</b>
G0997315		G2600561	6" w x 11 1/2" l x 4" h	<b>\$2.04</b>
G1863084		G2268734	6" w x 17 1/2" l x 4" h	<b>\$2.79</b>

**ACORN CORRUGATED BOX Corrugated Shelf Bins**

- Hopper style front
- 4 ply handlock lip
- 200 lb test rating
- MINIMUM 30% RECYCLED CONTENT AND COMPLETELY RECYCLABLE
- ► MORE SIZES ONLINE

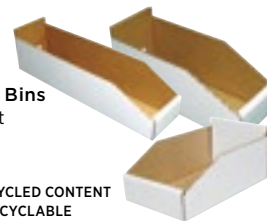

#	dimensions	price
G3782834	2 3/4" w x 11" l x 4 3/4" h	<b>\$0.49</b>
G3783412	4 3/4" w x 11" l x 4 3/4" h	<b>\$0.59</b>
G3783814	6 3/4" w x 11" l x 4 3/4" h	<b>\$0.89</b>
G3783324	8 3/4" w x 11" l x 4 3/4" h	<b>\$0.79</b>
G3783351	4 3/4" w x 17" l x 4 3/4" h	<b>\$0.79</b>
G3783762	6 3/4" w x 17" l x 4 3/4" h	<b>\$0.79</b>
G3783744	8 3/4" w x 17" l x 4 3/4" h	<b>\$0.79</b>

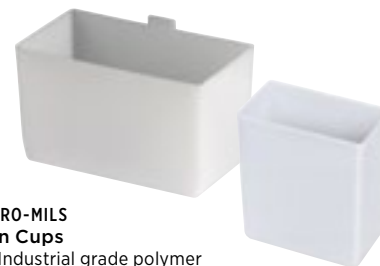

**AKRO-MILS Bin Cups**

- Industrial grade polymer
- For use with Akro-Mils shelf bins

#	dimensions	price
G3142842	2" w x 3 3/4" l x 3" h	<b>\$0.36</b>
G1950821	5" w x 2 3/4" l x 3" h	<b>\$0.63</b>



**AKRO-MILS Bin Dividers**

- Industrial grade polymer
- For use with Akro-Mils shelf bins
- Side to side
- 24 pack

#	shelf bin size	price
G1168657	4 3/4" wide	<b>\$8.92</b>
G2878084	6" wide	<b>\$9.69</b>



**AKRO-MILS Bin Hanging System**

- Use with Akro-Mils stack and hang bins — not included
- Blue powder coated steel
- Can be picked from either side
- 36" w x 20" d x 52" h

#	price
G0786947	<b>\$142.43</b>

**AKRO-MILS Bin Hanging System**

**Mobile Kit**

#	price
G2804304	<b>\$63.95</b>

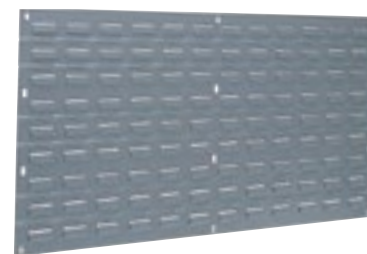

**AKRO-MILS Louvered Panels**

- Powder coated steel
- Use with Akro-Mils stack and hang bins — not included

#	size	price
G2731705	18" x 19"	<b>\$19.09</b>
G1487062	35 3/4" x 19"	<b>\$25.56</b>



eZTips about these products are available online at [www.zoro.com/eztips](http://www.zoro.com/eztips)



# MATERIAL HANDLING

MORE THAN 800,000 ITEMS ONLINE



### RUBBERMAID Utility Tote

- 15" w x 20" d x 5" h
- 4.63 gal
- Gray polyethylene
- ■ NSF STANDARDS

#	price
G0402516	<b>\$8.86</b>



### DURHAM Compartmented Parts Box

- 13 1/8" w x 9" d x 2 5/8" h
- 24 compartments
- 2 1/8" square compartments
- Clear polypropylene

#	price
G4266132	<b>\$6.15</b>



### PLANO MOLDING Adjustable Compartmented Parts Box

- 14" w x 9 1/8" d x 3 1/4" h
- 4 to 15 compartments
- 22 removable dividers
- Clear polypropylene

#	price
G4811947	<b>\$6.52</b>



### HOMZ Storage Tote

- 13" w x 16 1/4" d x 6 1/8" h
- 3.9 gal
- Clear polypropylene

#	price
G4178806	<b>\$7.22</b>



### RUBBERMAID Storage Tote

- 17 1/2" w x 27 7/8" d x 15 1/8" h
- 20 gal
- Gray polypropylene

#	price
G1835574	<b>\$28.19</b>



### SUNCAST Storage Totes

- Black/gray polypropylene

#	dimensions	volume	price
G0818282	19 3/4" w x 31 1/2" d x 15 3/8" h	32 gal	<b>\$30.86</b>
G2525302	23 1/2" w x 39 1/2" d x 20 1/2" h	50 gal	<b>\$52.73</b>



### J TERENCE THOMPSON Mobile Trunk

- 17 1/2" w x 37" d x 14" h
- Black polypropylene

#	price
G3133383	<b>\$49.33</b>



### PLANO MOLDING Mobile Trunk

- 18 1/2" w x 38 3/4" d x 21 1/4" h
- Black polypropylene

#	price
G4811956	<b>\$36.56</b>



### ORBIS Dairy Crate

- 13" w x 13" d x 11" h
- 1.1 cu-ft
- Black HDPE

#	price
G3697111	<b>\$7.65</b>



### AKRO-MILS Attached Lid Containers

- Industrial grade polymer

#	color	dimensions	price
G0370063	gray	15" w x 21 1/2" l x 9" h	<b>\$17.63</b>
G0851286	blue	15" w x 21 1/2" l x 9" h	<b>\$17.63</b>
G3123477	gray	15" w x 21 1/2" l x 17" h	<b>\$22.03</b>
G1357912	blue	15" w x 21 1/2" l x 17" h	<b>\$22.03</b>
G2468627	gray	15" w x 21 1/2" l x 12 1/2" h	<b>\$18.45</b>
G0555405	blue	15" w x 21 1/2" l x 12 1/2" h	<b>\$18.45</b>

**HOMZ Storage Tubs**

- Polypropylene
- Rope handles
- 21½" x 16½"
- 18 gal

Q #	color
G4302365	black
G3882925	navy

each **\$12.09**



**RUBBERMAID**

**Stock Tanks**

- Black high density structural resin
- All except 50 gal include drain plug

Q #	dimensions	volume	price
G1669656	31" w x 52" l x 12" h	50 gal	<b>\$90.92</b>
G0760261	31" w x 53" l x 25" h	100 gal	<b>\$102.49</b>
G3125175	39" w x 58" l x 25" h	150 gal	<b>\$171.61</b>
G1373872	69" w x 63¼" l x 25" h	300 gal	<b>\$271.05</b>
G0299065	32" w x 40½" l x 24" h	300 gal	<b>\$97.04</b>



**Replacement Drain Plug**

Q #	price
G2501073	<b>\$19.88</b>

**JUSTRITE Oily Waste Cans**

- Galvanized steel
- Foot operated lid
- Red powder coated
- ■ FM, UL STANDARDS
- ► MORE ONLINE

Q #	volume	height	price
G0318105	6 gal	15½"	<b>\$47.32</b>
G3440832	10 gal	18¾"	<b>\$54.96</b>
G1572611	21 gal	23½"	<b>\$90.79</b>



**BRIGGS & STRATTON Spill Proof Polyethylene Cans**

- Self-venting
- 5 gal
- 8½" x 14¾"
- 11½" spout
- ■ ASTM STANDARDS

Q #	fuel type	color	price
G3324815	diesel	yellow	<b>\$15.40</b>
G0805472	kerosene	blue	<b>\$17.41</b>
G3400555	gasoline	red	<b>\$23.92</b>



**Auto Shut-Off Spout**

Q #	price
G2863971	<b>\$6.94</b>

**BWAY HDPE Storage Pail**

- 12" outside dia
- 14½" height
- For solids
- 5 gal
- White

Pail Q #	price
G3970775	<b>\$17.93</b>

Screw Top Lid Q #	price
G4110522	<b>\$3.99</b>



**JUSTRITE Dispensing Bottle**

- Red polyethylene
- 4" outside dia
- 10½" height
- 1 quart
- ■ FM STANDARDS

Q #	price
G2616555	<b>\$27.15</b>



**BRIGGS & STRATTON Spill Proof Steel Gas Can**

- 14" x 19"
- 5 gal
- 11½" spout
- Red

Q #	price
G2914624	<b>\$51.03</b>



**QUANTUM STORAGE SYSTEMS Tip Out Bin Units**

- High impact polystyrene

Q #	no of bins	color	dimensions	price
G2290041	6	gray	23½" w x 3¾" d x 4½" h	<b>\$17.34</b>
G2249773	6	ivory	23¾" w x 3¾" d x 4½" h	<b>\$17.34</b>
G2506847	9	ivory	23¾" w x 2½" d x 3¾" h	<b>\$15.67</b>

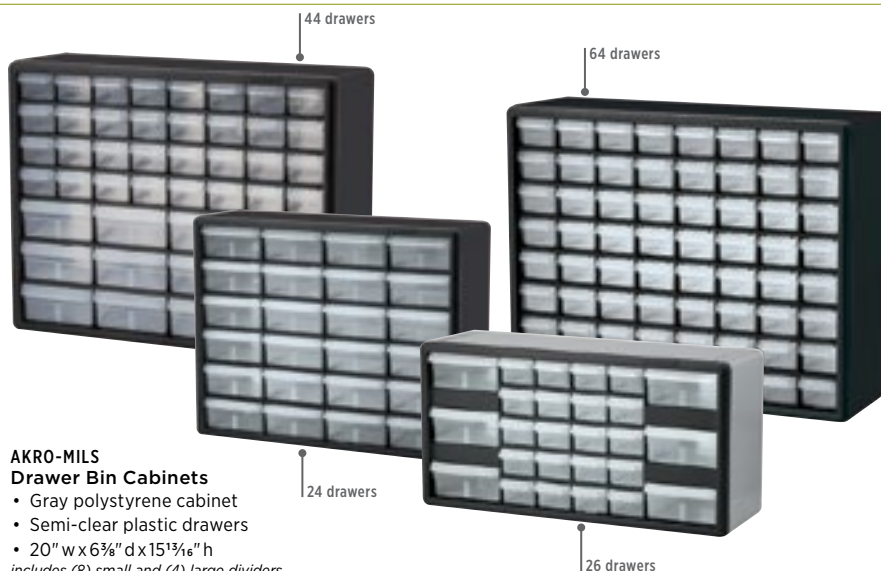

**AKRO-MILS Drawer Bin Cabinets**

- Gray polystyrene cabinet
- Semi-clear plastic drawers
- 20" w x 6¾" d x 15¼" h
- includes (8) small and (4) large dividers

Q #	no of drawers	drawer dimensions	price
G3904661	24	4¾" drawer depth, 2" drawer width, 5¼" drawer height,	<b>\$26.22</b>
G0353123	26	5¼" drawer depth, small 2¼", large 4¾" drawer width, small 1½", large 2" drawer height	<b>\$17.93</b>
G3917934	44	5¼" drawer depth, small 2¼", large 4¾" drawer width, small 1½", large 2" drawer height	<b>\$29.06</b>
G2213477	64	5¼" drawer depth, 2¾" drawer width, 1½" drawer height	<b>\$26.09</b>



## MATERIAL HANDLING

### DURHAM Stackable Pigeonhole Bin Unit

- Gray powder coated steel
- 72 bins
- 33 $\frac{3}{4}$ " w x 8 $\frac{1}{2}$ " d x 42" h cabinet
- 4" w x 8 $\frac{3}{8}$ " d x 4 $\frac{1}{2}$ " h bins

Q#	price
G0750976	<b>\$125.46</b>



### AKRO-MILS Drawer Bin Cabinets

- Gray baked enamel steel cabinet
- Polystyrene bin drawers
- 2 dividers per bin
- 17" w x 11" d x 11" h cabinet

Q#	no of bins	bin dimensions	price
G3494513	9	5 $\frac{3}{8}$ " w x 10 $\frac{1}{16}$ " d x 3 $\frac{1}{16}$ " h	<b>\$83.78</b>
G1053796	16	4" w x 10 $\frac{9}{16}$ " d x 2 $\frac{1}{8}$ " h	<b>\$87.85</b>
G0281872	28	2 $\frac{3}{16}$ " w x 10 $\frac{1}{16}$ " d x 2 $\frac{1}{16}$ " h	<b>\$81.43</b>



### DURHAM Pigeonhole Bin Units

- Gray powder coated steel

Q#	no of bins	cabinet dimensions	bin dimensions	price
G2442754	12	33 $\frac{3}{4}$ " w x 12" d x 23 $\frac{3}{8}$ " h	8" w x 11 $\frac{1}{8}$ " d x 6 $\frac{1}{8}$ " h	<b>\$70.39</b>
G3492885	24	33 $\frac{3}{4}$ " w x 12" d x 23 $\frac{3}{8}$ " h	5 $\frac{3}{8}$ " w x 11 $\frac{1}{8}$ " d x 5 $\frac{1}{2}$ " h	<b>\$72.75</b>
G0979955	40	33 $\frac{3}{4}$ " w x 12" d x 23 $\frac{3}{8}$ " h	4" w x 11 $\frac{1}{8}$ " d x 4 $\frac{1}{2}$ " h	<b>\$85.97</b>
G1131295	42	33 $\frac{3}{4}$ " w x 12" d x 42" h	5 $\frac{3}{8}$ " w x 11 $\frac{1}{8}$ " d x 5 $\frac{1}{2}$ " h	<b>\$137.08</b>
G2136635	56	33 $\frac{3}{4}$ " w x 12" d x 42" h	4 $\frac{7}{8}$ " w x 11 $\frac{1}{8}$ " d x 5 $\frac{1}{2}$ " h	<b>\$137.69</b>
G2498386	72	33 $\frac{3}{4}$ " w x 12" d x 42" h	4" w x 11 $\frac{1}{8}$ " d x 4 $\frac{1}{2}$ " h	<b>\$144.65</b>

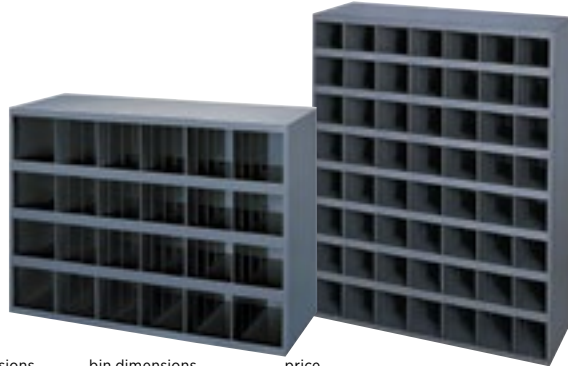

### Base for 11"-12" Depth Cabinets

- 34 $\frac{1}{8}$ " w x 12 $\frac{1}{4}$ " d x 5 $\frac{1}{4}$ " h

Q#	price
G1155542	<b>\$50.92</b>



### DURHAM Drawer Cabinets

- Gray powder coated steel

#### Cabinet with 4 drawers

- 20" w x 15 $\frac{3}{4}$ " d x 15" h cabinet
- 18" w x 12" d x 3" h drawers

Q#	price
G2766127	<b>\$178.26</b>



#### Cabinet Only

- 20 $\frac{1}{4}$ " w x 12" d x 15" h cabinet
- Holds (4) 18" w x 12" d x 3" h drawers

Q#	price
G2654994	<b>\$76.98</b>



#### Drawers Only

- 18" w x 12" d x 3" h

Q#	no of compartments	price
G2321925	9	<b>\$23.06</b>
G2832417	12	<b>\$36.13</b>
G2051542	16	<b>\$20.94</b>



### EDSAL Bin Storage Cabinet

- Gray powder coated steel
- 132 bins
- 38" w x 24" d x 72" h

Q#	price
G0364201	<b>\$1,357.75</b>



### EDSAL Floor Storage Unit

- Gray powder coated steel
- 56 corrugated white bins

Q#	price
G2876657	<b>\$171.46</b>



### JUSTRITE Safety Cabinets

- Galvanized steel
- For flammable liquids
- Yellow powder coated
- OSHA, NFPA, FM STANDARDS

Q#	capacity	dimensions	price
G1038545	12 gal	23 $\frac{3}{4}$ " w x 18" d x 35" h	<b>\$385.86</b>
G1912705	30 gal	43" w x 18" d x 44" h	<b>\$499.50</b>
G0814721	45 gal	43" w x 18" d x 65" h	<b>\$591.22</b>



### SUNCAST Stacking Drawers

- High impact polypropylene
- Gray with black drawers
- 18" w x 18" d x 36" h

#### Stackable Drawers

Q#	drawer dimensions	pack	price
G1358366	14 $\frac{1}{2}$ " w x 15" d x 15" h	2	<b>\$58.81</b>
G2234574	14 $\frac{1}{2}$ " w x 15" d x 6" h	4	<b>\$124.66</b>

#### Tower with 3 Drawers

- includes (4) casters

Q#	drawer dimensions	price
G1399395	14 $\frac{1}{2}$ " w x 15" d x (2)6"; (1)15" h	<b>\$61.72</b>







**SUNCAST Storage Cabinets**

- Polypropylene
- Lockable doors

**With Shelves**

Q#	shelves	color	dimensions	price
G3348956	1	gray	28" wx 11 1/2" dx 28" h	<b>\$66.20</b>
G1023687	2	gray/black	30" wx 20 3/4" dx 36 3/8" h	<b>\$70.88</b>
G2101617	4	gray/black	30" wx 20 3/4" dx 72 7/8" h	<b>\$141.11</b>

**With Drawers**

Q#	shelves	color	dimensions	price
G0328447	3	gray/black	30" wx 20 3/4" dx 36 3/8" h	<b>\$105.83</b>



**VALUE BRAND Storage Cabinets**

- Powder coated steel
- 4 shelves
- 36" w x 18" d x 72" h
- includes (2) keys and (3) point lock

Q#	color
G2608146	gray
G1952212	black

each **\$210.05**



**SUNCAST Storage Sheds**

- Impact resistant polypropylene
- Lockable
- Taupe

Q#	capacity	dimensions	price
G2055724	20 cu-ft	4' 7 3/4" wx 2' 6 1/4" dx 2' 10 3/8" h	<b>\$132.65</b>
G0772204	30 cu-ft	4' 8" wx 3' 3 1/4" dx 3' 3" h	<b>\$230.73</b>



**TENNSCO Wardrobe Storage Cabinet**

- Gray powder coated steel
- 2 shelves
- Coat rod
- 36" w x 18" d x 72" h
- includes (2) keys and (3) point lock

Q#	price
G0237081	<b>\$203.69</b>



**TENNSCO Wardrobe Lockers**

- Gray powder coated steel
- Louvered door
- One tier
- includes (3) one prong hooks

Q#	dimensions	price
G1846853	12" wx 15" d x 78" h	<b>\$188.24</b>

includes coat rod and (3) one prong hooks

Q#	dimensions	price
G3207075	12" wx 18" d x 78" h	<b>\$244.20</b>

includes coat rod and (3) one prong hooks

Q#	dimensions	price
G0670801	15" wx 18" d x 78" h	<b>\$169.69</b>



**SUNCAST Balcony Outdoor Storage Box**

- Durable resin
- 47 gal
- Taupe
- 28 7/8" w x 20 5/8" d x 30 3/8" h

Q#	price
G4309602	<b>\$92.11</b>



**TENNSCO Visibility Lockers**

- Powder coated steel
- 3 one prong hooks
- 12" w x 18" d x 78" h

Q#	tier	color	price
G5431553*	one	gray	<b>\$398.64</b>
G5431562*	one	sand	<b>\$398.64</b>
G5431571*	two	gray	<b>\$400.81</b>
G5431587*	two	sand	<b>\$400.81</b>



**EDSAL Storage Cabinet**

- Gray powder coated steel
- 4 shelves
- 3 point lock with locking handle
- 48" w x 24" d x 78" h

Q#	price
G1779522	<b>\$330.74</b>



### VALUE BRAND

#### Industrial Wire Shelving

- Chrome plated steel
- 4 shelves, adjustable in 1" increments
- 800 lb shelf capacity

Z#	dimensions	price
G3107036	24" w x 18" d x 63" h	<b>\$73.74</b>
G1354421	24" w x 24" d x 63" h	<b>\$87.15</b>
G1661852	24" w x 24" d x 74" h	<b>\$113.39</b>
G3350286	36" w x 18" d x 63" h	<b>\$78.19</b>
G2510995	36" w x 24" d x 63" h	<b>\$91.80</b>
G3235172	36" w x 24" d x 74" h	<b>\$118.37</b>
G1936453	48" w x 18" d x 63" h	<b>\$89.79</b>
G2916733	48" w x 24" d x 63" h	<b>\$108.31</b>
G1530864	48" w x 24" d x 74" h	<b>\$133.19</b>
G1513391	60" w x 18" d x 63" h	<b>\$102.97</b>
G3332542	60" w x 24" d x 63" h	<b>\$124.80</b>
G0422624	60" w x 24" d x 74" h	<b>\$150.82</b>



#### Clear Matte Plastic Shelf Liners

- 4 pack

Z#	dimensions	price
G3396233	24" x 18"	<b>\$8.85</b>
G2168406	24" x 24"	<b>\$10.93</b>
G2320701	36" x 18"	<b>\$10.58</b>
G0845022	36" x 24"	<b>\$13.19</b>
G0613891	48" x 18"	<b>\$12.39</b>
G3319111	48" x 24"	<b>\$15.63</b>
G1672352	60" x 18"	<b>\$14.24</b>
G2845333	60" x 24"	<b>\$18.06</b>

#### Caster With Brake

- 5" rubber wheel

Z#	price
G1286871	<b>\$15.49</b>



### EDSAL

#### Bulk Storage Racks

- Gray powder coated steel
- Particleboard decking
- 3 shelves
- 4,500 lb load

#### Starter

Z#	dimensions	price
G1199466	60" w x 18" d x 72" h	<b>\$228.03</b>
G1001576	60" w x 24" d x 72" h	<b>\$187.41</b>
G0944526	60" w x 36" d x 72" h	<b>\$198.44</b>

#### Add-On

Z#	dimensions	price
G0330872	60" w x 18" d x 72" h	<b>\$156.51</b>
G2638955	60" w x 24" d x 72" h	<b>\$164.32</b>
G0430105	60" w x 36" d x 72" h	<b>\$165.36</b>



### PLANO MOLDING

#### Vented Shelving

- Polypropylene
- 5 shelves, adjustable in 1½" increments
- ► MORE SIZES ONLINE

Z#	dimensions	price
G0549552	37" w x 18¾" d x 71¾" h	<b>\$62.78</b>
G1843414	37" w x 24¾" d x 71¾" h	<b>\$77.16</b>



### EDSAL

#### Boltless Shelving

- Gray powder coated steel
- Particleboard decking
- 5 shelves, adjustable in 1½" increments

Z#	dimensions	price
G0803232	36" w x 24" d x 72" h	<b>\$108.83</b>
G0748203	48" w x 24" d x 72" h	<b>\$125.98</b>



technical resources

eZTips about these products are available online at [zoro.com/eztips](http://zoro.com/eztips)

**80/20 T-Slotted Framing System**

- Extrusions**
- Anodized aluminum
  - Versatile
  - 72" length
  - Slot width .255"
  - .205" bore diameter

Item #	size	price
G2108382	1" x 1"	<b>\$21.70</b>
G1765513	1" x 2"	<b>\$35.19</b>
G3506754	1" x 3"	<b>\$54.12</b>

**Accessories**

Item #	description	pack	price
G3132902	t-slot cover		<b>\$4.41</b>
G2244085	end cap	2	<b>\$2.98</b>
G3243143	single t-nut with fastener	15	<b>\$8.94</b>
G1092734	double t-nut with fasteners	6	<b>\$8.48</b>
G2516701	end fastener		<b>\$1.92</b>
G3111744	drop-in t-nut		<b>\$2.56</b>
G0944842	2-hole inside corner bracket		<b>\$3.70</b>
G3114955	4-hole inside corner bracket		<b>\$5.18</b>
G0445523	4-hole joining plate		<b>\$6.12</b>
G1127594	tee 5-hole joining plate		<b>\$8.67</b>
G7584376	elbow 5-hole joining plate		<b>\$6.50</b>
G3351975	12-hole joining plate		<b>\$13.79</b>
G7620672	base plate		<b>\$8.14</b>
G1517607	anchor fastener		<b>\$3.71</b>
G0409001	2-hole inside gusset		<b>\$5.02</b>
G2132435	4-hole inside gusset		<b>\$7.19</b>
G1004552	hinge		<b>\$6.10</b>
G2047482	leveling foot		<b>\$14.93</b>



**HOLLAENDER Modular Rail Fitting System**

- Aluminum
- 1 1/4" pipe size
- 1.66" dia
- OSHA, IBC, BOCA, SBC AND UBC STANDARDS

- Pipe**
- Schedule 40
  - 8' length

Item #	pack	price
G3019432	5	<b>\$315.30</b>

**Fittings**

Item #	shape	price
G1938054	tee	<b>\$10.49</b>
G1831225	adjustable cross tee	<b>\$15.74</b>
G3298556	adjustable elbow	<b>\$16.43</b>
G0999661	rectangular flange	<b>\$15.42</b>
G2970073	wall flange	<b>\$13.77</b>
G3459897	adjustable flange	<b>\$39.46</b>



**EDSAL Slotted Angle Kits**

- Steel

**Post Kit**

- 14 gauge
- includes (5) slotted angle posts and (36) cadmium plated 5/16" x 3/4" bolts and nuts

Item #	dimensions	price
G2195803	2 3/4" w x 12' l x 1 1/2" d	<b>\$110.24</b>

**Post Kit**

- 12 gauge
- includes (5) slotted angle posts and (38) cadmium plated 5/16" x 3/4" bolts and nuts

Item #	dimensions	price
G2624745	3" w x 12' l x 1 1/2" d	<b>\$115.49</b>

**Cleat and Gusset Kit**

- includes (6) 12-gauge cleats each 2 3/4" x 1 1/2" x 9" long and (6) 14-gauge gussets each 6" x 6" x 8%

Item #	price
G2450235	<b>\$22.50</b>

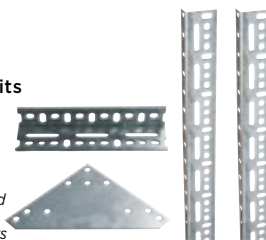



# MATERIAL HANDLING

## WERNER 6200 Series Stepladders

- Fiberglass
- Single sided
- Antislip tread
- 300 lb load capacity



Q#	height	steps	price
G2122644	4'	3	<b>\$60.48</b>
G0422581	5'	4	<b>\$70.72</b>
G3168137	6'	5	<b>\$79.25</b>
G0455271	7'	6	<b>\$105.36</b>
G1694831	8'	7	<b>\$107.09</b>

## LOUISVILLE AS2100 Series Stepladders

- Aluminum
- Single sided
- Antislip tread
- 250 lb load capacity



Q#	height	steps	price
G3076141	4'	3	<b>\$44.56</b>
G0959497	6'	5	<b>\$61.32</b>
G1458405	8'	7	<b>\$97.93</b>
G0645312	10'	9	<b>\$139.32</b>

## LOUISVILLE FM1400HD Series Stepladders

- Fiberglass
- Double sided
- Antislip tread
- 375 lb load capacity
- [▶ MORE SIZES ONLINE](#)



Q#	height	steps	price
G3429684	4'	3	<b>\$123.26</b>
G2459502	6'	5	<b>\$178.87</b>
G1087572	8'	7	<b>\$232.63</b>
G1326665	10'	9	<b>\$317.64</b>

## LOUISVILLE L-3022 Series Extension Ladders

- Fiberglass
- 12" adjustable increments
- Steel swivel safety shoe
- 300 lb load capacity



Q#	height	working height	price
G1054006	10' to 20'	17'	<b>\$187.41</b>
G1679307	12' to 24'	21'	<b>\$253.56</b>
G0503106	14' to 28'	25'	<b>\$242.54</b>

## WERNER D6200-2 Series Extension Ladders

- Fiberglass
- 12" adjustable increments
- Dual action shu-lok
- 300 lb load capacity



Q#	height	working height	price
G3122996	10' to 20'	17'	<b>\$219.70</b>
G2739292	12' to 24'	21'	<b>\$214.88</b>
G2131166	18' to 32'	29'	<b>\$331.07</b>

## LITTLE GIANT Flip-N-Lite Platform Stepladders

- Aluminum
- Antislip tread
- Heavy duty platform
- 300 lb load capacity
- [▶ MORE SIZES ONLINE](#)



Q#	height	steps	price
G4015654	5'	3	<b>\$72.85</b>
G4081366	6'	4	<b>\$99.84</b>

## WERNER T7400 Series Stepladders

- Fiberglass
- Double sided
- Antislip tread
- 375 lb load capacity
- [▶ MORE SIZES ONLINE](#)



Q#	height	steps	price
G2683904	4'	3	<b>\$115.23</b>
G2557511	6'	5	<b>\$186.66</b>
G2344937	10'	9	<b>\$318.28</b>

## XTEND & CLIMB Telescoping Ladders

- Aluminum
- 12" adjustable increments

Q#	load capacity	closed height	extended height	price
G1824575	225 lb	2' 5"	10' 6"	<b>\$294.54</b>
G2510024	250 lb	3'	15' 6"	<b>\$520.28</b>



## WERNER D1500-2 Series Extension Ladders

- Aluminum
- 12" adjustable increments
- Dual action shu-lok
- 300 lb load capacity



Q#	height	working height	price
G2421937	10' to 20'	17'	<b>\$195.04</b>
G1621855	14' to 28'	25'	<b>\$267.65</b>
G2780687	18' to 32'	29'	<b>\$310.30</b>

**BALLYMORE Folding Rolling Ladders**

- Blue powder coated steel
  - Perforated tread
  - 350 lb load capacity
- includes handrails*

**2 steps**

- Top platform height 20"

Z #	overall height	price
G3983594	42"	<b>\$164.92</b>

**3 steps**

- Top platform height 30"

Z #	overall height	price
G3901021	52"	<b>\$160.91</b>



**HAILO Platform Stepladders**

- Aluminum
- 3 steps
- Nonslip tread
- 330 lb load capacity
- 27¼" top platform

Z #	material	height	price
G1691776	aluminum	3'	<b>\$59.32</b>
G2166062	white powder coated steel	4'	<b>\$55.11</b>



**WERNER Extension Ladder Levelers**

- Aluminum
- Adjustable up to 8½"

Z #	description	price
G2687465	spring activated	<b>\$107.64</b>
G0968703	swivel shoe with ice pick	<b>\$102.83</b>

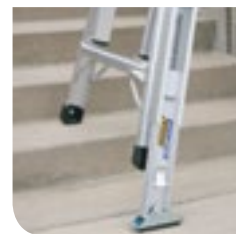

**WERNER Fold-Up Work Platform**

- Aluminum
- Ribbed tread
- 225 lb load capacity

Z #	platform dimensions	price
G3223297	10" w x 39½" l x 20% h	<b>\$50.92</b>



**PREMIER PLASTICS Step Stands**

- Yellow polyethylene
- 500 lb load capacity

Z #	steps	height	base	price
G4209895	2	20"	26" x 26"	<b>\$169.91</b>
G3910803	3	30"	28" x 43"	<b>\$362.97</b>



**WERNER Extension Ladder Cover Kit**

- Rubber
- includes (2) covers*

Z #	price
G3208721	<b>\$6.56</b>



**WERNER Extension Ladder Stabilizer**

- Aluminum
- includes paint can hook*

Z #	price
G2320482	<b>\$39.09</b>



**WERNER Van Utility Carrier**

- Powder coated steel
  - 600 lb load capacity
- features vinyl cargo protector strip*

Z #	price
G3336496	<b>\$125.00</b>



**WERNER Extension Ladder Jack Clamp**

- 300 lb load capacity

Z #	price
G0524797	<b>\$105.83</b>



**WERNER Stepladder Pail Shelf**

- Plastic
- For use with Werner 6000 and 6200 series stepladders

Z #	price
G0429423	<b>\$23.20</b>



**WERNER Job Bucket**

- Plastic
- For use with Werner 6200 series and jobstation ladders
- 25 lb load capacity

Z #	price
G2145622	<b>\$13.15</b>



**LITTLE GIANT Tool Storage**

- Nylon and steel
- For use with Little Giant ladders
- 25 lb load capacity

Z #	price
G4995645	<b>\$30.00</b>



**LADDER LOCK Extension Ladder Lock**

- Trivalent coated steel

Z #	price
G4294762	<b>\$41.15</b>



**LOUISVILLE Attic Ladder**

- Aluminum
- 350 lb load capacity
- 25½" x 63" opening
- 90" clearance
- 17" step width
- For 10' to 12' ceiling

Z #	price
G5199731	<b>\$286.75</b>





# MATERIAL HANDLING

MORE THAN 800,000 ITEMS ONLINE



### RUBBERMAID Mobile Work Center Cart

- 5 metal lockable storage drawers
- Plastic handles with built-in cord wrap
- 4" lockable casters
- 250 lb capacity
- 19<sup>13</sup>/<sub>16</sub>" w x 32<sup>5</sup>/<sub>8</sub>" l x 33<sup>1</sup>/<sub>2</sub>" h

Z#	price
G1319586	<b>\$363.66</b>



### RUBBERMAID Service Bench Utility Cart

- Structural foam
- 5" lockable casters
- 330 lb capacity
- 19<sup>1</sup>/<sub>4</sub>" x 38"

includes (2) part boxes and (4) part bins

Z#	height	locking cabinet	price
G1264155	33 <sup>3</sup> / <sub>8</sub> "	without	<b>\$358.22</b>
G3326583	33 <sup>3</sup> / <sub>8</sub> "	with	<b>\$488.97</b>

### RUBBERMAID Service Carts

- Heavy duty structural foam
- 5" casters — (2) rigid and (2) swivel
- Two shelves
- 500 lb capacity

18" w x 39" l x 33" h

- Black

Z#	price
G2559453	<b>\$188.99</b>



18" w x 39" l x 33" h

- Beige

Z#	price
G2001912	<b>\$175.70</b>



26" w x 45" l x 33" h

- Black

Z#	price
G1839397	<b>\$198.19</b>



### RUBBERMAID Ergonomic Utility Carts

- Structural foam
- 5" casters — (2) rigid and (2) swivels
- Ergonomically designed handle
- Easy to reach tool/accessory hooks and storage area
- 500 lb capacity

Z#	dimensions	price
G3019457	25" w x 43 <sup>3</sup> / <sub>8</sub> " l x 32 <sup>3</sup> / <sub>4</sub> " h	<b>\$202.27</b>
G0470242	25 <sup>1</sup> / <sub>2</sub> " w x 45 <sup>1</sup> / <sub>4</sub> " l x 33 <sup>1</sup> / <sub>2</sub> " h	<b>\$193.40</b>



### RUBBERMAID HDPE Utility Carts

- Ergonomic design
- 4" swivel casters
- 300 lb capacity
- 20" x 40<sup>3</sup>/<sub>8</sub>"

Z#	shelves	height	price
G1350666	3	37 <sup>3</sup> / <sub>8</sub> "	<b>\$232.91</b>
G3257791	4	51"	<b>\$305.10</b>



### VALUE BRAND Mobile Workbench Cabinet

- Steel with gray powder coat
- 5" casters — (2) rigid and (2) swivel
- Three shelves and drawers
- 500 lb capacity
- 28" w x 16" l x 34" h

includes (4) hanging plastic bins and built-in tool caddy

Z#	price
G1703782	<b>\$158.14</b>



### VALUE BRAND 4 Tier Stock Cart

- Steel with gray powder coat
- 5" casters — (2) rigid and (2) swivel
- 6" adjustable increments
- 800 lb capacity
- 24" w x 40" l x 60" h

Z#	price
G2323255	<b>\$159.75</b>



### METRO Wire Utility Carts

- Steel with chrome finish
- 5" rubber swivel casters
- Two shelves
- 1" adjustable increments
- 600 lb capacity

Z#	dimensions	price
G0970751	18" w x 36" l x 39" h	<b>\$192.93</b>
G1345382	18" w x 48" l x 39" h	<b>\$232.02</b>
G0469962	24" w x 36" l x 39" h	<b>\$236.48</b>
G0650343	24" w x 48" l x 39" h	<b>\$286.64</b>

### VALUE BRAND Wire Security Cart

- Steel with chrome finish
- 5" phenolic casters — (2) rigid and (2) swivel
- 1,800 lb heavy duty load capacity
- 24" w x 48" l x 70" h
- Shelves not included

Z#	price
G0415703	<b>\$889.76</b>



### VALUE BRAND Wire Shelf

- Steel with chrome finish
- 225 lb capacity
- 1/4" lip
- 24" x 48"

Z#	price
G0634514	<b>\$55.20</b>



**RUBBERMAID  
Cube Trucks**

- Medium density polyethylene
- Diamond pattern mounted casters – (2) rigid and (2) swivel
- **USDA STANDARDS**

**Trucks**

Q#	capacity	width	length	height	size	price
G0330933	300 lb	26"	38"	28.1"	8 cu-ft	<b>\$269.69</b>
G0860885	400 lb	28"	42.8"	33"	12 cu-ft	<b>\$352.77</b>
G2480353	500 lb	31"	43.8"	37"	16 cu-ft	<b>\$429.04</b>

**Lids**

Q#	capacity	width	length	height	fits	price
G2384672	300 lb	25.8"	38.4"	8.5"	8 cu-ft truck	<b>\$149.82</b>
G2719175	400 lb	27.5"	43.1"	8.5"	12 cu-ft truck	<b>\$164.13</b>
G0995531	500 lb	31"	44.1"	8.5"	16 cu-ft truck	<b>\$177.07</b>



**RUBBERMAID Tilt Trucks**

- Medium density polyethylene
- Steel frame
- Inset wheels

**1/2 cu-yd Trucks**

Q#	capacity	width	length	height	price
G0609287	300 lb	28"	56 3/4"	38 3/8"	<b>\$445.39</b>
G0413201	450 lb	26 1/2"	57 1/2"	33 3/8"	<b>\$451.35</b>
G0862032	850 lb	26 1/2"	57 1/2"	33 3/8"	<b>\$479.44</b>
G3064171	1400 lb	28"	60 1/2"	38 3/8"	<b>\$841.74</b>

**1 cu-yd Trucks**

Q#	capacity	width	length	height	price
G1236304	600 lb	33 1/2"	73 3/4"	44 5/8"	<b>\$608.83</b>
G0540477	850 lb	33 1/2"	72 1/4"	43 5/8"	<b>\$679.66</b>
G1605475	1,250 lb	33 1/2"	72 1/4"	43 5/8"	<b>\$928.91</b>
G1897506	2,100 lb	33 1/2"	72 1/4"	43 3/4"	<b>\$1,070.56</b>



**RUBBERMAID  
Dump Carts**

- Structural foam
- Pneumatic wheels
- Built-in hand grips
- Positive locking latch and safety bail

Q#	size	capacity	width	length	height	price
G1480997	8 cu-ft	750 lb	39 1/4"	60"	25"	<b>\$209.75</b>
G3174857	10 cu-ft	1,200 lb	35 1/2"	68"	29 1/2"	<b>\$384.09</b>
G1187505	15 cu-ft	1,500 lb	39 1/2"	75 1/8"	33 3/4"	<b>\$513.49</b>



**ROYAL  
Basket Trucks**

- Vinyl basket
- Wood and steel frame
- 3" polyurethane swivel casters
- 25 cu-ft capacity
- 32" w x 48" d x 36 1/2" h

Q#	color	price
G0028655	red	<b>\$241.24</b>
G0028664	blue	<b>\$289.79</b>



**RUBBERMAID  
Big Wheel Carts**

- Structural foam frame
- High density polyethylene hopper
- 20" wheels

Q#	size	capacity	width	length	height	price
G0307711	1/2 cu-yd	200 lb	27 1/2"	47"	24 3/4"	<b>\$194.10</b>
G0877396	1/4 cu-yd	300 lb	32 3/4"	58"	28 3/4"	<b>\$222.00</b>



**RUBBERMAID  
Recycling Cart**

- Plastic
- 5" casters (2) rigid and (2) swivel
- 500 lb capacity
- 31" w x 43.8" d x 37" h
- **USDA STANDARDS**

Q#	price
G3992213	<b>\$429.04</b>



**ROYAL  
Mail Cart**

- High density polyethylene basket
- Powder coated steel frame
- 4" casters – (2) swivel and (2) rigid
- 1,200 lb capacity
- 31 1/4" w x 48" d x 37" h
- includes vinyl liner and removable vinyl webbing to secure load*

Q#	price
G3428214	<b>\$460.28</b>



**AKRO-MILS  
Heavy Duty Cart**

- Polyethylene cart with steel frame
- (2) 10" semi-pneumatic wheels
- (1) 4" swivel caster
- 450 lb capacity
- 30 1/2" w x 47" d x 39 1/2" h

Q#	price
G2874837	<b>\$374.45</b>



**ROYAL  
X-Frame  
Laundry Cart**

- 1" steel tubular frame
- Vinyl bag
- 3" polyolefin casters
- 150 lb capacity
- 21" w x 26" d x 36" h

Q#	price
G0257722	<b>\$94.80</b>





# MATERIAL HANDLING

MORE THAN 800,000 ITEMS ONLINE



- ORBIS Food Service Dolly**
- Lip-up plastic platform
  - 3" polypropylene swivel casters
  - 400 lb capacity
  - 22½" w x 27½" l x 6" h

Z#	price
G4963393	<b>\$52.06</b>



- DAYTON Keg/Case Truck**
- Aluminum with silver finish
  - 10" semi-pneumatic wheels
  - Beveled noseplate
  - 500 lb capacity
  - 19" w x 14" l x 51" h

Z#	price
G3404292	<b>\$292.78</b>



- AKRO-MILS Cylinder Truck**
- Holds one cylinder
  - 10" pneumatic wheels
  - 500 lb capacity
  - 14" x 6" baseplate

Z#	price
G4021701	<b>\$279.45</b>



- DAYTON Convertible Hand Truck**
- Rustproof nylon polymer frame with steel handle
  - (2) 5" casters
  - (2) 10" pneumatic wheels
  - 600 lb capacity
  - 21" w x 18" l x 50" h

Z#	price
G1202731	<b>\$142.35</b>



- EDSAL Cabinet Dolly**
- Lip-up steel platform
  - 3" polypropylene swivel casters
  - 1,000 lb capacity
  - 18" w x 36" l x 4" h

Z#	price
G4189561	<b>\$28.38</b>



- VALUE BRAND Folding Hand Truck**
- Aluminum/polypropylene
  - 5" rubber wheels
  - 175 lb capacity
  - 15½" w x 16¼" l x 39" h
  - Folds down to 15½" w x 2¼" l x 25" h
  - includes bungee*

Z#	price
G1193114	<b>\$57.93</b>



- GREENLEE Wire Spool Hand Truck**
- Steel frame
  - 5 reel axles with spring-clip retainers
  - 2 positions for axle storage
  - 750 lb capacity
  - 27" w x 26½" l x 54½" h

Z#	price
G2576506	<b>\$310.69</b>



- B & P MANUFACTURING Fold Down Snack Truck**
- Aluminum with polished finish
  - 8" balloon cushion wheels
  - Single grip handle
  - 200 lb capacity
  - 17½" w x 16" l x 73" h
  - includes folding nose latch*

Z#	price
G1154386	<b>\$379.25</b>

- DAYTON General Purpose Hand Trucks**
- Steel with rust-resistant powder coat
  - 10" solid rubber wheels
  - 800 lb capacity
  - 8" deep noseplate

**Dual Handle**

Z#	size	price
G2783523	19½" x 47"	<b>\$155.42</b>

**Continuous Handle**

Z#	size	price
G2834562	20½" x 46"	<b>\$155.42</b>

- DAYTON Nose Plate Extension**
- 650 lb capacity
  - 22" width
  - Increases noseplate to 25"

Z#	price
G3113801	<b>\$31.54</b>







**RUBBERMAID Platform Trolleys**

- Nonskid polypropylene platform
- Three-position handle
- 5" swivel casters
- 20½" w x 32½" l x 7" h

Q #	capacity	price
G2272961	250 lb	<b>\$113.73</b>
G3440263	500 lb	<b>\$140.97</b>



**WESCO Extendable Platform Truck**

- Aluminum with retracting handle
- 4" rubber casters — (2) rigid and (2) swivel
- 330 lb capacity
- 17½" w x 21" l x 36½" h
- 29½" extended length

Q #	price
G1313094	<b>\$134.73</b>



**VALUE BRAND Portable Hydraulic Lift Table**

- Steel
- 4" phenolic casters — (2) rigid and (2) swivel
- 2,000 lb capacity
- 24" x 36" platform
- 36" to 54" adjustable height

Q #	price
G0702712	<b>\$780.34</b>



**VALUE BRAND Standard Platform Trucks**

- Sealed wood deck
- Steel frame and removable handle
- Polyolefin casters — (2) rigid and (2) swivel

Q #	capacity	deck height	dimensions	price
G1951101	2,600 lb	8¾"	24" w x 48" l x 36" h	<b>\$205.99</b>
G1232612	2,800 lb	9¾"	30" w x 60" l x 37" h	<b>\$228.98</b>



**DAYTON U-Boat Platform Truck**

- Powder coated steel frame
- Polyurethane casters — (2) rigid and (4) swivel
- 2,000 lb capacity
- 10¾" deck height
- 16" w x 60" l x 60¼" h

Q #	price
G2363155	<b>\$278.05</b>



**DAYTON Scissor Lift Carts**

- Fixed steel platform
- Down speed control valve
- Hydraulic powered foot pump
- Polyurethane casters — (2) rigid and (2) swivel with brake

Q #	capacity	platform	adjustable height	price
G3406663	400 lb	17¾" x 27½"	8¾" to 29¾"	<b>\$537.01</b>
G2033701	800 lb	20" x 35½"	13¾" to 51"	<b>\$1,193.54</b>
G1107784	1,000 lb	31¾" x 63"	12¾" to 35¾"	<b>\$1,070.70</b>



**RUBBERMAID Heavy Duty Platform Truck**

- Plastic deck
- Removable powder coated steel handle
- 8" rubber casters — (2) fixed and (2) swivel
- 2,000 lb capacity
- 11¼" deck height
- 24" w x 48" l x 41¼" h

Q #	price
G0412553	<b>\$441.31</b>



**DAYTON Hydraulic Pallet Trucks**

- Control lever for selecting "raise", "neutral", and "lower" positions
- Steel
- Cushion grip handle
- 7" polyurethane wheels
- 48" fork length

Narrow				
Q #	capacity	adjustable height	width across forks	price
G0438076	5,500 lb	2¾" to 7¾"	20½"	<b>\$530.37</b>
Standard				
Q #	capacity	adjustable height	width across forks	price
G2640976	5,500 lb	3" to 7¾"	27"	<b>\$557.76</b>
G1700194	6,000 lb	3" to 7½"	27"	<b>\$633.29</b>



**HILMAN ROLLERS Equipment Roller Kit**

- 10½" swivel rollers
- 80,000 lb capacity
- 48" handle
- 5¾" w x 10½" l x 5¼" h
- includes (4) 20,000 lb capacity rollers and (2) 48" handles

Q #	price
G1531223	<b>\$1,818.49</b>



# MATERIAL HANDLING

MORE THAN 800,000 ITEMS ONLINE



### ALBION Weight Activated Gate Caster

- 2" thermoplastic rubber wheels
- Zinc plated steel frame with 1 7/8" x 2 1/2" plate
- Ball bearings
- 7/8" x 1 1/2" bolt hole spacing
- 75 lb load rating
- 16 1/2" height

Z#	price
G4809095	<b>\$37.27</b>



### VALUE BRAND Swivel Plate Casters

- Polyolefin wheels with steel frame
- Plain bore bearings
- 1 3/4" x 3" bolt hole spacing
- 3 3/4" x 2 3/4" plate
- ■ ISO 9001 STANDARDS

Z#	wheel	height	load rating	price
G2792291	3"	4 3/16"	176 lb	<b>\$5.99</b>
G1216722	4"	4 3/16"	198 lb	<b>\$6.49</b>
G0867666	5"	5 5/8"	220 lb	<b>\$7.99</b>



### VALUE BRAND Rigid Plate Casters

- Antistatic polyurethane wheels with steel frame
- Plain bore bearings
- 1 3/4" x 3" bolt hole spacing
- 3 3/4" x 2 3/4" plate
- ■ ISO 9001 STANDARDS

Z#	wheel	height	load rating	price
G1579627	3"	3 3/4"	176 lb	<b>\$8.29</b>
G2477212	4"	4 3/16"	198 lb	<b>\$8.49</b>
G3258561	5"	5 5/8"	220 lb	<b>\$8.89</b>



### ALBION Low Profile Casters

- 3" wheels with enamel steel frame
- Roller bearings
- 2 3/8" x 3 3/8" bolt hole spacing
- 3 3/8" x 4 1/8" plate

#### Swivel

Z#	material	height	load rating	price
G1956333	polypropylene	3 3/32"	500 lb	<b>\$22.55</b>
G0998155	glass filled nylon	4 5/32"	1,200 lb	<b>\$69.81</b>

#### Rigid

Z#	material	height	load rating	price
G1934624	polypropylene	3 3/32"	500 lb	<b>\$20.61</b>
G3298635	glass filled nylon	4 5/32"	1,200 lb	<b>\$25.57</b>



### REVVO Swivel Stem Casters

- 4" polyurethane wheels
- Ball bearings
- 176 lb load rating
- 5" height
- 10mm diameter stem
- 15mm long
- ■ ISO 9001 STANDARDS

Z#	total lock	price
G2856025	without	<b>\$38.47</b>
G2303883	with	<b>\$53.32</b>



### ALBION Shopping Cart Casters

- 5" polyurethane wheels
- Dual ball bearings
- 350 lb load rating
- 5 7/8" height

includes (1) self decelerating wheel and (2) antistatic casters

Z#	stem	stem length	price
G1418672	1/2" -13 threaded	1"	<b>\$18.54</b>
G0266165	3/4" square	1 3/4"	<b>\$18.66</b>



### REVVO Kingpinless Casters

- Phenolic wheels
- Steel frame with polished zinc finish
- Roller bearings
- 3" x 3" inside and 2 5/8" x 3 3/8" outside bolt hole spacing
- 4" x 4 1/2" plate

Z#	wheel	height	load rating	price
G2456711	5"	6 1/2"	1,000 lb	<b>\$50.54</b>
G1008174	6"	7 1/2"	1,200 lb	<b>\$60.49</b>
G2589903	8"	9 1/2"	1,400 lb	<b>\$61.97</b>



### ALBION Shock-Absorbing Plate Casters

- 6" polyurethane wheels
- Zinc plated steel frame with 4 1/2" x 4" plate
- Roller bearings
- 500 lb load rating
- 3" x 3" inside and 2 5/8" x 3 3/8" outside bolt hole spacing
- 8 1/2" height

Z#	plate	price
G0878622	swivel	<b>\$173.29</b>
G2399293	rigid	<b>\$154.32</b>

### VALUE BRAND V-Groove Rigid Casters

- 4" cast iron wheels
- Zinc plated steel frame with 4" x 4 1/2" plate
- Roller bearings
- 800 lb load rating
- 2 5/8" x 3" inside and 3" x 3 3/8" outside bolt hole spacing
- 5 5/8" height

#### Castors

Z#	wheel width	price
G2446656	1 1/2"	<b>\$18.32</b>
G1611215	2"	<b>\$20.86</b>

#### Replacement Wheel

Z#	wheel width	price
G1939691	1 1/2"	<b>\$9.07</b>
G2537272	2"	<b>\$10.93</b>



**SHEPHERD CASTER Stem Caster Mounting Sockets**

- For use with wood or metal tubing
- Fits 7/16" x 7/8" and 7/16" x 1 1/8" friction ring stems
- Press fit mounting
- 1" x 1 3/4"
- 5 pack

includes mounting grip ring, grip neck or THD fastening



#	inside tube
G0918075	0.87"
G3328726	0.902"

pack **\$6.24**

**VESTIL Adjustable Floor Locks**

- 3/8" mounting plate and mounting bolt
- Slotted for 3 3/8" x 5 1/4", 3" x 3" and 2 1/8" x 4 3/4" bolt holes
- 4 1/2" x 6 1/2"

includes suction cup bottom for added traction



#	mounting height	retracted height	use with	price
G0603477	5 3/4" to 8"	4 3/4" to 7"	4", 5" and 6" casters	<b>\$40.89</b>
G0663957	7 3/4" to 10 1/2"	6 1/4" to 9 1/2"	8" and 10" casters	<b>\$61.10</b>

**ALBION Thermoplastic Rubber Caster Wheels**

- 2 3/16" polypropylene hub
- Roller bearings
- Resists water, oil, chemicals and most acids
- Fits 1/2" axle



#	wheel	load rating	price
G2452904	6"	600 lb	<b>\$17.45</b>
G1245535	8"	675 lb	<b>\$25.28</b>

**BASSICK Phenolic Caster Wheels**

- 2 3/16" hub
- Roller bearings
- Resists solvents and acids
- Fits 1/2" axle



#	wheel	load rating	price
G1370801	4"	800 lb	<b>\$8.96</b>
G3347075	5"	1,000 lb	<b>\$13.00</b>
G2388741	6"	1,200 lb	<b>\$14.59</b>

**HAMILTON Polyurethane Caster Wheels**

- 2 1/4" cast iron hub
- Precision ball bearings
- Resists water, oil and light chemicals
- Fits 1/2" axle



#	wheel	load rating	price
G2704895	4"	750 lb	<b>\$33.06</b>
G3002763	6"	1,200 lb	<b>\$42.01</b>
G0578724	8"	1,500 lb	<b>\$58.83</b>

**VALUE BRAND Polyolefin Caster Wheels**

- 2 7/16" hub
- Roller bearings
- Resists water, oil, chemicals and most acids
- Fits 3/8" and 1/2" axles



#	wheel	load rating	price
G2852175	4"	300 lb	<b>\$10.08</b>
G1335643	8"	1,000 lb	<b>\$15.93</b>

**ALBION Never Flat Wheels**

- Solid polyurethane tires
- Offset steel hub
- Ball bearings
- Airless and nonmarking



#	wheel	tread	capacity	fits	price
G1675475	8"	ribbed	300 lb	1/2" axle	<b>\$47.98</b>
G0914173	10"	sawtooth	350 lb	3/8" axle	<b>\$53.25</b>

**WORKSMAN Bicycle Seats**

- For use on bicycles with 7/8" seat post



#	size	price
G1486231	9" standard	<b>\$25.42</b>
G1116762	13" extra wide	<b>\$25.57</b>

**WORKSMAN Bicycle Wheel**

- 26" wheel
- 2 1/8" tube
- 11 gauge spokes



#	price
G2493111	<b>\$105.08</b>

**VALUE BRAND Solid Rubber Tires**

- Ribbed tread
- Symmetrical steel hubs
- Ball bearings
- Fits 3/8" axle



#	tire	capacity	price
G1324355	8"	400 lb	<b>\$11.26</b>
G1096986	10"	450 lb	<b>\$15.97</b>

**WORKSMAN Bicycle Tube**

- For use on bicycles or tricycles
- Puncture resistant
- Fits 26" wheels
- 2 1/8" tube



#	price
G3042654	<b>\$12.12</b>

**WORKSMAN Spare Tires**

- For use on bicycles or tricycles
- 2 1/8" tube

#	wheel	price
G2300934	24"	<b>\$20.40</b>
G2290425	26"	<b>\$21.11</b>





## MATERIAL HANDLING

### VALUE BRAND Steel Drums

- Carbon steel material
- Rust inhibitor interior coating
- For use with packing groups I, II and III of hazardous materials
- ■ DOT, UN STANDARDS
- ► MORE ONLINE

#### Open Head Drums

Z#	capacity	load	dia	height	price
G1180891	10 gal	264 lb	14¼"	19"	<b>\$56.10</b>
G0946994	55 gal	957 lb	22½"	34½"	<b>\$78.39</b>

#### Closed Head Drums

Z#	capacity	load	dia	height	price
G1620026	10 gal	116 lb	14¼"	19¼"	<b>\$45.99</b>
G1877111	30 gal	374 lb	18¾"	29½"	<b>\$55.99</b>

#### Salvage Drums

Z#	capacity	load	dia	height	price
G2444513	10 gal	264 lb	14¼"	19"	<b>\$59.30</b>
G0650291	20 gal	385 lb	19¼"	21½"	<b>\$81.94</b>



### VALUE BRAND Salvage Drum Lifter

- Welded steel construction
- For use with closed drums
- 55 and 85 gal drum capacity
- 1000 lb load capacity
- 9" w x 24" l x 16" h

Z#	price
G4301586	<b>\$95.87</b>



### EAGLE Drum Cover

- 100 % high density polyethylene
- Snap on design
- Resistant to most chemicals, acids and solvents
- Dome shaped top
- For closed head 55 gal metal drums

#### Closed Head

Z#	opening	price
G1661642	23"	<b>\$6.27</b>

#### Open Head

Z#	opening	price
G1911253	24"	<b>\$5.69</b>



### VALUE BRAND Drum Heater

- Electric powered
- 1000 watts
- 8.7 A AC
- 115 V
- For use with metal drum

Z#	price
G1206581	<b>\$159.53</b>



### VALUE BRAND Drum Dolly

- Steel material
- Polyolefin caster material
- Resistant to most chemicals, acids and solvents
- Features high capacity load
- 6½" height
- includes (16) bolts and (16) nuts*

#### Four Caster Drum Dolly

- 1000 lb dolly capacity
- 26¾" outside capacity
- 23¼" inside diameter

Z#	price
G2643697	<b>\$48.87</b>



#### Five Caster Drum Dolly

- 1250 lb dolly capacity
- 24¾" outside capacity
- 23¾" inside diameter

Z#	price
G1881966	<b>\$66.06</b>



### JUSTRITE Drum Cover

- 16 gauge steel
- 55 application
- Recommended for combustible trash
- 22¾" opening
- Resistant to most chemicals, acids and solvents

Z#	price
G0887853	<b>\$110.07</b>

### VALUE BRAND Safety Bollard

- 36" overall height
- Carbon steel
- Hard surface mounting
- 0.125" wall thickness
- 8" w x 8" l x ¾" h mounting plate dimensions

Z#	price
G0896244	<b>\$79.99</b>



### IDEAL SHIELD Bollard Cover

- Slide on
- Smooth pattern
- 52" height
- 10 lb net weight

Z#	post dia	price
G4022627	4"	<b>\$58.39</b>
G4040127	6"	



### AT-A-GLANCE Level Gauge

- 55 gal drum capacity
- 33.5" tank depth
- Aluminum bushing
- Galvanized steel rod material
- HDPE plastic float material

#### Type B55

Z#	dia	price
G1588395	¾" NPT	<b>\$55.11</b>
G3385846	2" NPT	<b>\$36.37</b>

#### Type B55 ALLSS

Z#	dia	price
G1860284	2 NPT"	<b>\$249.75</b>



### DAYTON Hand Operated Drum Pump

- Rotary
- 135 rpm
- Cast iron body
- 140°F max temp
- 1¼" discharge tube length

Z#	price
G1223643	<b>\$126.99</b>



See more rotary pumps on page 55

### EAGLE Post Sleeve

- 6" dia post size
- Ribbed pattern
- HDPE with UV inhibitors
- 56" height
- 10 lb net weight

Z#	color	price
G1792804	yellow	<b>\$36.38</b>
G1157877	red	





**VALUE BRAND Collapsible Manhole Guard Rail**

- Steel material
- 37 lb weight
- 33" w x 33" l x 42" h

Z#	price
G4265012	<b>\$198.74</b>

**REESE Trailer Jack Wheel Dock Chock**

- 1½" height
  - For use with trailer jacks with wheels
- includes high impact polymer with 3" center hole



Z#	price
G3305881	<b>\$5.92</b>

**VALUE BRAND Wheel Chock**

- Safety tread surface
- Molded hole for attaching chain
- 8" w x 11" d x 8" h



Z#	price
G2851667	<b>\$29.71</b>

**VALUE BRAND Wheel Chock**

- Grooved surface
  - 10" w x 6" d x 8" h
- includes steel grab handle and eye bolt

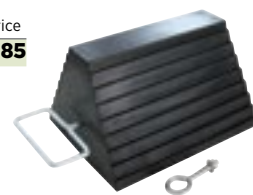

Z#	price
G1868553	<b>\$16.85</b>

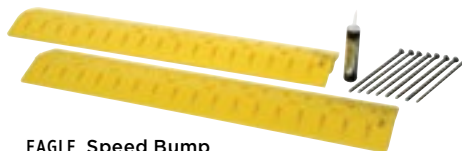

**EAGLE Speed Bump Cable Guard**

- Polyethylene material
- 20,000 lb load capacity

Z#	dimensions	price
G2231311	6' w x 10" d x 2" h	<b>\$58.60</b>
G3353314	9' w x 10" d x 2" h	<b>\$116.97</b>

**VALUE BRAND Folding Gates**

- Steel
- Universal mounting

**Single**

Z#	opening	height	folded	price
G3256705	3' to 4'	6'	8" x 6½'	<b>\$87.43</b>
G2285577	5' to 6'	6'	8½" x 6½'	<b>\$151.02</b>

**Double**

Z#	opening	height	folded	price
G1624156	8' to 10'	6'	11½" x 6½'	<b>\$224.35</b>
G3431863	10' to 12'	6'	8½" x 6½'	<b>\$259.52</b>
G1237065	12' to 14'	7'	11½" x 7½'	<b>\$361.17</b>

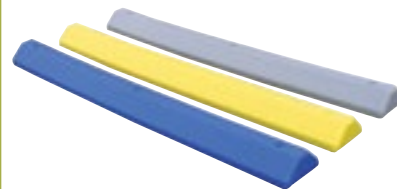
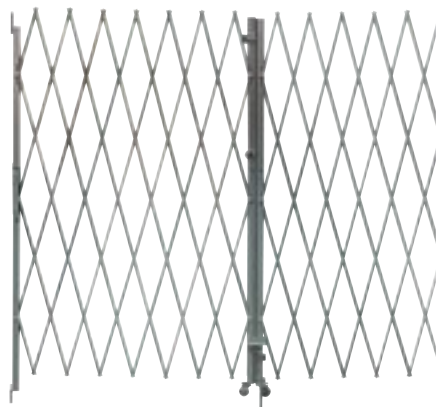

**EAGLE Parking Curbs**

- Polyethylene material
  - 8" w x 72" l x 4" h
- includes (3) anchor spikes



Z#	colors
G0154533	yellow
G0154542	gray
G0154551	blue

each **\$47.18**

**VALUE BRAND Posts**

- Steel
- Bolt on mounting
- 10" w x 10" l x ⅝" h mounting plate dimensions
- 4" x 4" post dimensions

Z#	description	price
G0941613	center post (18½" single height)	<b>\$80.39</b>
G2793375	corner post (18½" single height)	<b>\$80.39</b>
G1005401	center post (42¾" double height)	<b>\$134.19</b>
G0980025	corner post (42¾" double height)	<b>\$134.19</b>

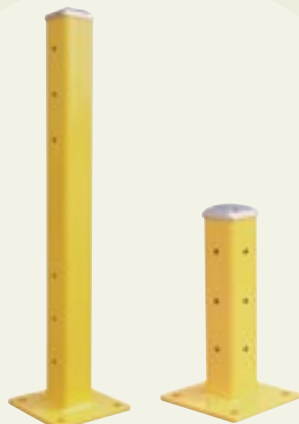

**VALUE BRAND Bolt-On Guard Rails**

- Steel material
  - Bolt on mounting
  - 3 ribs
  - 15" x 3½" mounting plate dimensions
- MORE ONLINE

Z#	length	price
G0784813	2'	<b>\$78.25</b>
G1347717	3'	<b>\$86.80</b>
G1612396	4'	<b>\$99.58</b>
G1161316	6'	<b>\$126.81</b>
G0767855	7'	<b>\$157.92</b>
G0253757	8'	<b>\$163.43</b>
G2223751	10'	<b>\$208.10</b>

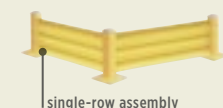

single-row assembly

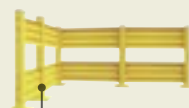

double-row assembly



**VALUE BRAND Speed Bump**

- Concrete mounting hardware
- Recycled plastic material
- 9½" w x 106" l x 2½" h

Z#	price
G2655292	<b>\$173.75</b>

**VALUE BRAND Rubber Dock Bumper**

- ⅜" mounting holes
- 2 mounting holes
- 2½" w x 17½" d x 6" h bumper
- 2" w x 2" d x 6" h total

Z#	price
G4026093	<b>\$6.12</b>





# MATERIAL HANDLING

## VALUE BRAND Heavy Duty Spring Snap

- Zinc plated steel
- 2" length
- 3/8" eye diameter
- 1/4" snap opening
- 175 lb load max



Z#	price
G1942656	<b>\$0.85</b>

## DAYTON Wire Rope Sleeves

- Aluminum alloy
- 25 pack



Z#	size	price
G3453895	1/2"	<b>\$7.15</b>
G3212571	3/8"	<b>\$13.91</b>
G1441526	5/16"	<b>\$21.29</b>

## B-LINE BY EATON Wire Rope

- Zinc plated



Z#	cable size	cable length	price
G1846661	3/16"	500'	<b>\$182.93</b>
G1132801	1/8"	500'	<b>\$239.18</b>
G1915943	3/16"	250'	<b>\$294.98</b>

## VALUE BRAND Pulleys

- Zinc
- Wall/ceiling mount
- For use with 3/8" rope



Z#	diameter	capacity	width	height	price
G0424076	1 1/2"	420 lbs max	2 5/8"	2 7/8"	<b>\$19.48</b>
G0938411	2"	480 lbs max	3 3/4"	2 1/2"	<b>\$25.11</b>

## VALUE BRAND Wire Rope Pulley Block

- Steel, zinc plated finish
- 3/8" cable max
- 4" sheave diameter
- 3000 lb working load limit

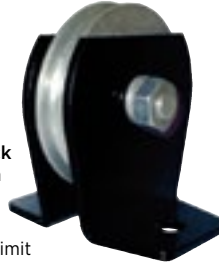

Z#	price
G2781545	<b>\$23.11</b>

## VALUE BRAND Wire Rope Pulley Block

- Steel, zinc plated finish
- 3/16" cable max
- 3 1/2" sheave diameter
- 1550 lb working load limit



Z#	price
G0652312	<b>\$13.99</b>

## PEERLESS Well Wheel Pulley Block

- Electro-galvanized finish
- Designed for fibrous rope
- 3/4" rope diameter
- 10 3/4" sheave diameter
- 1000 lb working load limit
- Plain bearing



Z#	price
G4488416	<b>\$81.61</b>

## VALUE BRAND Sheave

- Steel
- Galvanized finish
- 3/8" bronze bearing
- 3/8" cable max
- 5" sheave diameter
- 1850 lb working load limit
- Designed for wire rope



Z#	price
G3208441	<b>\$11.99</b>

## VALUE BRAND Rope Snatch Block

- Steel with epoxy finish
- Bronze bearing
- 3/4" rope diameter
- 6" sheave diameter
- 6000 lb working load limit
- Designed for synthetic rope



Z#	price
G1076905	<b>\$59.98</b>

## GOLDLINE Bungee Straps

- EPDM rubber
- Steel hardware
- S-hook
- 3/4" width
- For use with tarps



Z#	length	price
G4293003	15"	<b>\$1.18</b>
G4292994	21"	<b>\$1.41</b>

## POLAR PLASTICS Construction Film

- 10' x 100'
- 4 mil thickness
- Polyethylene

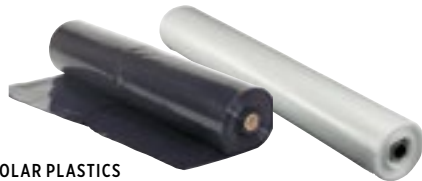

Z#	color	price
G3338544	clear	<b>\$33.06</b>
G2312676	black	<b>\$39.27</b>



**VALUE BRAND Insulated Tarp**

- Orange polyethylene
- Aluminum grommets
- Seams are heat-sealed
- Resists water, mildew and UV
- 11 7/8' x 19 1/2' finished size
- 1/4" thickness

*features insulating foam core*

Z#	price
G1401671	<b>\$137.13</b>



**VALUE BRAND Canvas Tarp**

- 10 oz green cotton canvas
- Seams are double lock stitched
- Resists water and mildew
- 19 1/2' x 19 1/2' finished size
- 20 mil thickness

*features nickel plated brass grommets every 2'*

Z#	price
G2135734	<b>\$244.92</b>

**TUF-TUG  
Rope Block and Tackle**

- 350 lb lifting capacity
  - 700 lb pull capacity
  - 12' reach
  - 5/8" hook opening
  - 3/8" x 50' rope
- includes cam lever load lock, heat-treated and drop-forged steel latch

#	price
G2738775	<b>\$40.95</b>



**DAYTON  
Ratchet Puller**

- Steel, zinc plated finish
  - 1000/2000 lb lifting capacity
  - 2000/4000 lb pull capacity
  - 15' cable length
  - 7/8" hook opening
  - **ASME STANDARDS**
- includes preformed galvanized aircraft cable and self-aligning cable guide that minimizes cable wear and (3) hooks

#	price
G2297915	<b>\$93.25</b>



**TANIS  
Strip Brush**

- Galvanized steel backing
- Chemical resistant
- 3/16" x 7/32" backing
- 3" crimped nylon trim
- 72" length

#	price
G2944453	<b>\$15.32</b>



**ASHLAND CONVEYOR  
Light Duty Conveyor  
H Stand**

- Green epoxy powder finish
- 1500 lb capacity
- 24" width, 22" between frame
- 19 1/2" to 31" height adjustment
- Pivoting mounting bracket allows sloped installations

#	price
G1472956	<b>\$65.23</b>



**ASHLAND CONVEYOR  
Straight Roller Conveyors**

- Epoxy powder paint
- Bolted design
- Ball bearings
- 270 lb roller capacity
- 1.9" roller diameter, 40 rollers per conveyor section, rollers are set high within the frame

#	size	price
G2628841	24 3/4" x 10'	<b>\$475.04</b>
G2815102	38 3/4" x 10'	<b>\$409.99</b>

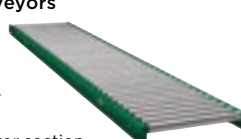

**VALUE BRAND  
Tie-Down Straps**

- Alloy steel plate
- Ratchet adjustment
- 1" x 15' strap
- 400 lb working load limit
- 1200 lb breaking strength
- 2 pack

#	price
G2534673	<b>\$14.72</b>



**LIFT-ALL  
Web Slings**

- Heavy-duty endless sling
- Tuff-edge construction with latex coating
- 3200 lb vertical hitch capacity
- 2500 lb choker hitch capacity
- 1" web width
- **OSHA, ASME STANDARDS**

#	length	price
G0333812	4'	<b>\$17.55</b>
G3246451	6'	<b>\$19.75</b>
G1360256	8'	<b>\$26.46</b>



**DAYTON  
Web Sling Set**

- Heavy-duty endless sling
  - Nylon with non-hazardous acrylic coating
  - 2000 lb vertical hitch capacity
  - 1600 lb choker hitch capacity
  - 1" width
  - **OSHA, ASME STANDARDS**
- includes (1) each 30", 40", and 50" sling, red core yarn wear indicator and permanent identification tag

#	price
G0352177	<b>\$34.53</b>



**LIFT-ALL  
Cargo Strap**

- Yellow polyester strap with heavy-duty steel hardware
- U-hook fitting style, ratchet buckle
- 2" x 27'
- 3300 lb working load limit
- 10,000 lb breaking strength

#	price
G2520962	<b>\$24.72</b>



**LIFT-ALL  
Round Slings**

- Polyester
  - Endless sling
  - Resists UV sunlight, grease and most acids
  - **OSHA, ASME STANDARDS**
- includes permanent identification tag

#	color	length	diameter	vert. hitch	choker hitch	basket hitch	price
G2408655	red	10'	1 3/8"	13,200 lbs	10,600 lbs	26,400 lbs	<b>\$73.06</b>
G2289086	blue	20'	1 3/4"	21,200 lbs	17,000 lbs	42,400 lbs	<b>\$256.38</b>

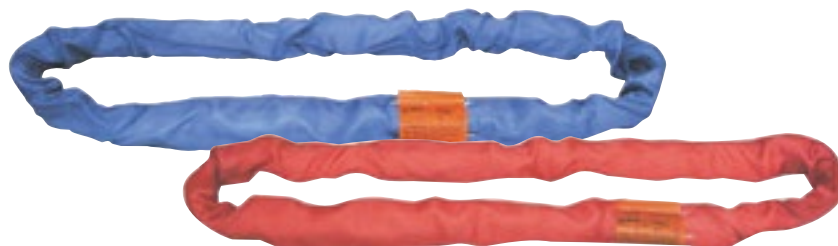

**DAYTON  
SGG Chain Sling**

- Grade 80 alloy steel with painted finish
- Grab hooks attach at each end
- 3500 lb working load limit
- 3/32" x 10' chain

includes orange master links and hooks and black oxide chain

#	price
G2829766	<b>\$130.10</b>



**DAYTON  
Grade 80 Chain Sling**

- Alloy steel with painted finish
  - Adjustable link
  - Control plate and (2) sling hooks
  - 3500 lb single capacity
  - 3/32" x 6' chain
- includes red hooks, red master link and black chain

#	price
G0888772	<b>\$172.02</b>





# MATERIAL HANDLING

## MAG-MATE PowerLift Lifting Magnets

- Neodymium magnet
- On/off locking handle
- RFID enabled
- ■ ASME STANDARDS



Z#	flat capacity	round capacity	price
G3212553	250 lbs	150 lbs	<b>\$243.62</b>
G1792752	800 lbs	400 lbs	<b>\$498.91</b>
G1448745	1600 lbs	800 lbs	<b>\$825.94</b>

## ERIEZ Lifting Magnet

- Neodymium magnet
- On/off locking handle
- 1100 lb max capacity flat
- 550 lb max capacity round
- ■ ASME STANDARDS



Z#	price
G1712523	<b>\$641.99</b>

## POWR-GRIP Suction Cup Lifters

- Flat cup with horizontal handle
- 125 lb max load capacity
- 8" diameter
- includes carrying case and features red-line vacuum indicator*



Z#	handle	price
G3392523	ABS plastic	<b>\$51.89</b>
G0369205	metal	<b>\$79.88</b>

## DAYTON Mini Lever Chain Hoist

- 6' hardened steel chain
- 5' lift, 1<sup>3</sup>/<sub>16</sub>" hook opening
- 500 lb load capacity
- ■ ANSI, ASME STANDARDS
- includes safety latch hooks*



Z#	price
G0630725	<b>\$125.54</b>

## COFFING LSB-B Series Lever Chain Hoist

- 10' lift, 1<sup>5</sup>/<sub>16</sub>" hook opening
- 11' hardened steel chain
- 9<sup>3</sup>/<sub>4</sub>" lever length
- 1650 lb load capacity
- ■ ANSI, ASME STANDARDS
- includes safety latch hooks*



Z#	price
G0491452	<b>\$276.57</b>

## CM Low Headroom Chain Hoists

- Has self-adjusting brake
- ■ ANSI, ASME STANDARDS
- includes swivel hooks with safety latches*



Z#	lift	load capacity	price
G1100942	10'	1000 lbs	<b>\$99.29</b>
G2892732	20'	2000 lbs	<b>\$275.05</b>

## CM SHOPAIR Air Chain Hoist

- 300 lb load capacity
- 10' lift
- 0 to 31 fpm lift speed
- Operates on 34 scfm at 90 psi
- includes standard overload clutch, as well as (2) reduction gearing*



Z#	price
G3191605	<b>\$1,537.75</b>

## DAYTON Electric Chain Hoist

- 500 lb load capacity
- 10' lift
- 8 fpm
- 115 V
- 3 A, 60 Hz
- ■ ANSI, ASME STANDARDS



Z#	price
G3509956	<b>\$800.95</b>

## CM SHOPSTAR Electric Chain Hoist

- 300 lb load capacity
- 10' lift
- 16 fpm
- 115 V, 2.7 A
- ■ ANSI, ASME STANDARDS



Z#	price
G1599893	<b>\$929.99</b>

## DAYTON Electric Chain Hoist

- 4000 lb load capacity
- 20' lift
- 8 fpm
- 240/460V 3 phase
- Multiple disc motor brake
- ■ ANSI, ASME STANDARDS



Z#	price
G2043702	<b>\$5,849.01</b>

## OZ LIFTING PRODUCTS Electric Wire Rope Hoist

- 500 lb load capacity
- 90' lift
- 115 V, 7 A
- ■ ANSI, ASME STANDARDS



Z#	price
G4500395	<b>\$1,463.45</b>

## DAYTON Heavy-Duty Trolley

- Solid machined cast iron
- Use with electric, air and manual hoists
- Sealed precision bearings
- 2000 lb load capacity
- Fits beam width 2<sup>5</sup>/<sub>8</sub>" to 5<sup>5</sup>/<sub>8</sub>"



Z#	price
G1265022	<b>\$192.15</b>



**RUD CHAIN  
VLBG Hoist Ring**

- Heat-treated alloy steel with a pink powder coating
- 5500 lb working load limit
- 180° pivot
- 360° swivel angle
- ¾ - 10 threaded size
- ■ ISO STANDARDS



Q #	price
G3356245	<b>\$173.10</b>

**CM  
Plate Clamps**

- Hardened steel
- Vertical lift operation
- Load activated
- Load ring lifting point
- ■ ANSI/ASME STANDARDS



Q #	working load	jaw capacity	price
G3341012	1100 lbs	0 to ¾"	<b>\$237.46</b>
G1880803	3300 lbs	0 to ¾"	<b>\$311.33</b>

**CM  
Grade 30  
Proof Coil Chain**

- Low carbon steel
- Zinc plated finish
- 140' length
- 9.8 straight links per foot
- 1300 lb working load limit



Q #	price
G1082234	<b>\$227.12</b>

**CM  
Grade 70  
Transport Chain**

- Steel
- Gold chromate finish
- ¾" trade size
- 6600 lb working load limit
- 60' length



Q #	price
G0886566	<b>\$174.63</b>

**VALUE BRAND  
Bungee Cord Rolls**

- Rubber



Q #	length	diameter	price
G1199791	250'	¾"	<b>\$64.92</b>
G2219122	300'	¾"	<b>\$92.53</b>

**VALUE BRAND  
Rope**

- White cotton
- 108 lb working load limit
- 1080 lb tensile strength
- ¾" x 600' rope
- ■ CORDAGE INSTITUTE STANDARDS



Q #	price
G3351643	<b>\$189.12</b>

**B/A  
PRODUCTS CO.  
Winch Cable**

- Steel
- 4800 lb working load limit
- ¾" diameter
- 150' length
- ■ SAE STANDARDS



includes eye and swivel latch hook

Q #	price
G4782023	<b>\$120.35</b>

**DAYTON  
Hand Winch  
with Brake**

- Steel
- Powder coated
- Zinc plated finish
- Used for lifting or pulling up to 3500 lb
- 8¼" w x 10½" l x 8¼" h
- ■ SAE STANDARDS

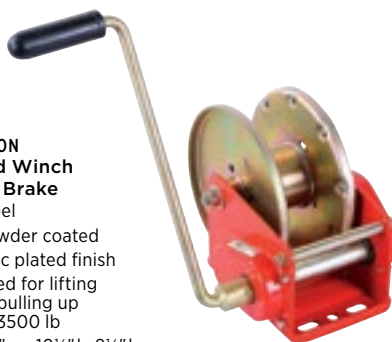

Q #	price
G4132651	<b>\$288.43</b>

**DAYTON  
Electric Winch**

- ½ hp
- 115 VAC, 10 A
- 13 fpm full load
- 23 fpm no load
- 1000 lb single line pulling capacity

includes 45' wire rope



Q #	price
G0624705	<b>\$397.36</b>

**DAYTON  
Electric Winch with Freespooling Clutch**

- 1 hp
- 115 VAC, 16.4 A
- 10.3 fpm full load
- Single stage planetary gear

includes 100' wire rope

Q #	price
G1895582	<b>\$1,376.97</b>



**STRONGARM  
Electric Winch**

- 1 hp
- 115 VAC, 8 A
- 3.5 fpm full load
- 18 fpm no load
- 2700 lb single line

includes 25' wire rope

Q #	price
G3690172	<b>\$522.19</b>



**DAYTON  
Hydraulic Winch**

- 27 fpm full load
- 47 fpm no load
- 15,000 lb single line pulling capacity
- Bi-directional drum rotation
- 153' max length rope

Q #	price
G3452836	<b>\$2,673.43</b>





# MACHINE TOOLS, COMPRESSORS & HYDRAULICS



## TOP BRANDS



### MOTORS

pg  
211



### PULLEYS AND SHEAVES

pg  
213



### BEARINGS

pg  
215



### MILLING

pg  
218



### MACHINING

pg  
219



### AIR COMPRESSORS

pg  
220



### VACUUM PUMPS

pg  
222



### AIR TOOLS

pg  
228



### HYDRAULIC CYLINDERS

pg  
230



### HYDRAULIC PUMPS

pg  
231



### DAYTON Brake Motors

- C-Face magnetic disc
- For rapid stopping and holding power conveyors, door openers and general machine drives
- 115/208-230 V @ 60 Hz
- 3450 max rpm
- ■ BISSC CERTIFIED, COMPLIES WITH NEMA DEFINITION MG1-1.26.5, USDA APPROVED, COMPLIES WITH 3A DAIRY STANDARDS

#### Washdown

#	static torque	IEC frame	max HP	price
G1841822	3 Ft.-Lb	56C NEMA	1	<b>\$444.47</b>
G1976615	6 Ft.-Lb	56C/140TC NEMA	2	<b>\$518.75</b>

#### Standard

#	static torque	IEC frame	max HP	price
G1128802	3 Ft.-Lb	56C NEMA	1	<b>\$259.38</b>
G2167374	6 Ft.-Lb	56C/140TC NEMA	2	<b>\$285.73</b>



washdown



standard

### DAYTON 90VDC Gearmotors

- Die cast zinc gear case
- 40° C max ambient temp
- Parallel shaft
- TENV enclosure
- ■ cRUus STANDARDS



#	rpm	max torque	overhung load	gear ratio	price
G2517505	21	50 in.-lb	50 lb	141:1	<b>\$178.87</b>
G0401082	47	26 in.-lb	50 lb	62:1	<b>\$178.87</b>
G0781121	93	13 in.-lb	50 lb	32:1	<b>\$178.87</b>

### DART CONTROLS DC Speed Controls

- For use with material handling, laboratory, food processing, pump, fan/blower, conveyor, machine tool, DC motor and spooling
- 115/230 VAC input
- 90/180 VDC output
- ¼ to 1 HP and ½ to ½ HP higher/lower volts
- ■ cULus RECOGNIZED AND CE CERTIFIED



#	price
G0491547	<b>\$72.75</b>

### DAYTON 3-Phase General Purpose Motors

- Open dripproof
- 213/5T frame
- 208-230/460 V
- Keyed shaft
- ■ UL RECOGNIZED, CSA CERTIFIED, CE



#	hp	rpm	shaft dia	shaft length	nominal efficiency	price
G0505836	3	1175	1 3/8"	3 3/8"	88.5%	<b>\$641.18</b>
G2656263	5	1165	1 3/8"	3 3/8"	89.5%	<b>\$691.81</b>
G3010244	7 1/2	1755	1 3/8"	3 3/8"	91.0%	<b>\$618.35</b>
G0371533	10	1755	1 3/8"	3 3/8"	91.7%	<b>\$744.93</b>

### DAYTON ODP General Purpose motors

- Capacitor start
- 56 frame
- 1 speed
- Keyed shaft
- 115/208-230 V
- ■ UL RECOGNIZED (E47479), CSA CERTIFIED (156060)



#	hp	rpm	shaft dia	shaft length	nominal efficiency	price
G0766342	¼	1725	5/8"	1 1/8"	68.3%	<b>\$257.30</b>
G0612507	1	1725	5/8"	1 1/8"	66.0%	<b>\$269.75</b>
G2830685	1 1/2	3450	5/8"	1 1/8"	82.6%	<b>\$297.14</b>

### DAYTON DC Speed Controls

- For packaging equipment, pumps, fans, blowers, conveyors and other constant or diminishing torque
- 90/180 VDC output
- 115/230 VAC



#	@higher voltage	@lower voltage	speed range	price
G2726324	½ to ¼ HP	⅓ to ⅕ HP	50:1	<b>\$515.02</b>
G3248025	¼ to 2 HP	⅕ to 1 HP	50:1	<b>\$566.06</b>

### DAYTON 115VAC/DC Gearmotors

- Steel input gear
- Cast iron output gear
- 40° C max ambient temp
- Reversible
- Open vented enclosure
- #404 woodruff keyway



#	rpm	max torque	overhung load	gear ratio	price
G0462262	4.5	250 in.-lb	100 lb	1714:1	<b>\$247.96</b>
G0518752	24	85 in.-lb	100 lb	229:1	<b>\$247.96</b>
G1154711	55	39 in.-lb	100 lb	100:1	<b>\$247.96</b>

### DAYTON DC Speed Controls

- For use with 90/180 VDC motors
- 115/230 VAC input
- 90/180 VDC output
- ½ to ½ HP and ½ to ½ HP at higher/lower volts
- ■ cULus LISTED



#	price
G1584694	<b>\$95.53</b>

### MARATHON ELECTRIC TEFC Washdown Motors

- Capacitor start
- Epoxy coated frame
- Face/base mounting
- Keyed shaft
- 115/208-230 V
- ■ UL RECOGNIZED (E47479), CSA CERTIFIED (LR63596), USDA APPROVED



#	hp	rpm	shaft dia	shaft length	nominal efficiency	price
G3457501	½	1725	5/8"	1 1/8"	66%	<b>\$334.51</b>
G3272884	1	1725	5/8"	1 1/8"	75%	<b>\$352.94</b>
G0699851	2	1740	5/8"	1 1/8"	80%	<b>\$690.29</b>

### DAYTON Motor Start Capacitors

- Plastic case
- -40° to 65° C
- 220-250 V
- ■ CULS RECOGNIZED (E224674)



#	microfarad rating	price
G0970855	105-126	<b>\$13.58</b>
G2244356	216-259	<b>\$16.28</b>
G1466333	233-280	<b>\$17.36</b>
G2030497	270-324	<b>\$19.25</b>

### DAYTON 12VDC Gearmotors

- For industrial and agricultural valve actuators
- Die cast zinc gear case and housing
- 40° C max ambient temp
- Parallel shaft



#	rpm	max torque	overhung load	gear ratio	price
G1052773	12	40 in.-lb	24 lb	603:1	<b>\$57.77</b>
G3118726	17	30 in.-lb	21 lb	394:1	<b>\$51.79</b>
G3064677	25	20 in.-lb	18 lb	270:1	<b>\$66.77</b>

### DAYTON 115VAC Gearmotors

- For restaurant equipment, water softener valve controls
- CW rotation
- Shaded pole motor
- Oil impregnated sintered bronze bearings
- ■ UL/CSA STANDARDS



#	rpm	max torque	overhung load	gear ratio	price
G2446543	1.1	50 in.-lb	3.5 lb	2645:1	<b>\$52.87</b>
G1761837	6.9	35 in.-lb	3.5 lb	439:1	<b>\$52.87</b>
G2566304	7	30 in.-lb	3.5 lb	439:1	<b>\$66.77</b>

### DART CONTROLS DC Speed Controls

- For use with material handling, laboratory, food processing, pump, fan/blower, conveyor, machine tool, DC motor and spooling
- 115/230 VAC input
- 90/180 VDC output
- ¼ to 2 HP and ½ to 1 HP higher/lower volts
- ■ cULus LISTED



#	price
G0297297	<b>\$236.63</b>



MORE THAN 800,000 ITEMS ONLINE

# MACHINE TOOLS & ACCESSORIES

## DAYTON V-Belts

- Rubber body w/polyester cords
- Wrapped construction
- 1/2" top width
- 3/16" thick

### Type FHP

②#	outside length	industry#
G2742311	20"	4L200
G1621821	21"	4L210
G0369336	22"	4L220
G1116035	23"	4L230
G2643742	24"	4L240
G1095753	25"	4L250
G2821935	26"	4L260
G1749867	27"	4L270
G0698616	28"	4L280
G3207653	29"	4L290

each **\$5.00**



## POWERTWIST PLUS Link V-Belts

- Composite polyurethane/polyester construction
- Provide a longer-lasting, permanent upgrade for V-belt drives
- Superior resistance to oil, water, and chemicals
- -40° to 240° F

### Type A/4L

②#	length	top width	thickness	price
G3722311	5'	3/4"	3/8"	<b>\$29.99</b>
G3611456	25'	3/2"	3/8"	<b>\$163.82</b>
G3665541	100'	3/2"	3/8"	<b>\$592.77</b>

### Type B/5L

②#	length	top width	thickness	price
G3742776	6'	5/8"	5/8"	<b>\$48.07</b>
G3731217	25'	5/8"	5/8"	<b>\$219.55</b>
G3604063	100'	5/8"	5/8"	<b>\$687.87</b>

### Type A

②#	outside length	industry#	price
G3308076	40"	A38	<b>\$12.86</b>
G1582296	41"	A39	<b>\$12.96</b>
G1686641	42"	A40	<b>\$13.21</b>
G0565765	43"	A41	<b>\$13.40</b>
G0851724	44"	A42	<b>\$13.69</b>
G1947014	45"	A43	<b>\$13.97</b>
G2931372	46"	A44	<b>\$14.08</b>
G1972747	47"	A45	<b>\$14.28</b>
G2213845	48"	A46	<b>\$14.34</b>
G2474446	49"	A47	<b>\$14.51</b>



## TSUBAKI Chain Detacher



②#	ANSI type	price
G0389846	25-60	<b>\$35.00</b>
G0320153	60-100	<b>\$63.92</b>

## FENNER DRIVES Chain Pullers

- For use on roller chain



②#	ANSI type	price
G1502557	35 to 60	<b>\$25.50</b>
G2475225	80 to 240	<b>\$58.42</b>

## TSUBAKI Roller Chains

- Standard riveted carbon steel
- 15° to 300° F
- 10' length
- ■ AMERICAN NATIONAL STANDARDS INSTITUTE (ANSI)  
includes (1) connecting link

### Single Strand

②#	chain size	pitch	roller diameter	width	max allowable load	price
G0878342	35 ANSI	3/8"	0.200"	0.500"	480lb	<b>\$30.76</b>
G2128436	40 ANSI	1/2"	0.312"	0.717"	810lb	<b>\$31.96</b>
G1378876	50 ANSI	3/4"	0.400"	0.878"	1430lb	<b>\$49.38</b>

### Double Strand

②#	chain size	pitch	roller diameter	width	max allowable load	price
G2698446	40-2	1/2"	0.312"	1.283	1370lb	<b>\$75.89</b>
G0413314	50-2	3/4"	0.400"	1.595	2430lb	<b>\$93.99</b>
G3499885	60-2	3/4"	0.469"	1.988	3360lb	<b>\$141.77</b>



## POWER DRIVE V-Belt Tension Checker

- Up to 35 lbs tension
- For use with 3L, 4L, 5L, A, B, C, D, 3V, 5V and 8V
- Sizes 10" to 170"

②#	price
G0489587	<b>\$19.99</b>



## POWER DRIVE V-Belt Wall Rack

- 36" long
- 6 hooks

②#	price
G3553785	<b>\$13.22</b>



## POWER DRIVE V-Belt Rule

- For use with 3L, 4L, 5L, A, B, 3V and 5V belts
- Sizes up to 100"
- includes aluminum slide adjustment

②#	price
G1633545	<b>\$33.06</b>



## GOODYEAR ENGINEERED PRODUCTS TensionRite Belt Frequency Meter

- For use with rubber compound belts
- includes calibration tuning fork, protective case and (4) AA batteries

②#	price
G2050447	<b>\$1,442.76</b>



## TSUBAKI Connecting Roller Chain Links

- Carbon steel
- 15° to 300° F
- 5 pack

### Single Strand

②#	chain size	price
G0686427	35 ANSI	<b>\$5.04</b>
G1646197	40 ANSI	<b>\$5.29</b>
G0759001	50 ANSI	<b>\$5.95</b>

### Double Strand

②#	chain size	price
G3157901	40-2 ANSI	<b>\$11.49</b>
G2596203	50-2 ANSI	<b>\$14.32</b>



### TSUBAKI Single Strand Sprockets

- Fixed bore
- Screw set located directly over keyway and 90° from keyway



• ■ ANSI SPROCKET NUMBER 40  
includes standard keyway and (2) set screws

Ⓐ #	OD	pitch dia	teeth	bore dia	set screw dia	price
G1125031	1.840"	1.618"	10	3/4"	3/4"	<b>\$18.00</b>
G0693156	2.170"	1.932"	12	3/4"	3/4"	<b>\$14.53</b>
G1798632	2.490"	2.247"	14	1"	5/16"	<b>\$14.58</b>
G3207215	2.81"	2.563"	16	1"	5/16"	<b>\$13.57</b>
G0710875	3.460"	3.196"	20	3/4"	3/4"	<b>\$36.84</b>

### CONGRESS Fixed Bore V-Belt Pulleys

- Die cast Zymak 3
- For 3L, 4L or A type V-belts
- Single groove
- Bushing not required



includes set screw

#### 1/2" Bore Diameter

Ⓐ #	OD	belt pitch dia	ax belt pitch dia	price
G1603393	1.5"	1.05" 3L	1.35" 4L, A, AX	<b>\$4.84</b>
G0606767	2"	1.55" 3L	1.85" 4L, A, AX	<b>\$4.44</b>
G2894875	3"	2.55" 3L	2.85" 4L, A, AX	<b>\$6.87</b>
G1159846	6"	5.55" 3L	5.85" 4L, A, AX	<b>\$12.88</b>
G2490293	12"	11.55" 3L	11.85" 4L, A, AX	<b>\$30.02</b>

#### 3/8" Bore Diameter

Ⓐ #	OD	belt pitch dia	ax belt pitch dia	price
G1697823	1.5"	1.05" 3L	1.35" 4L, A, AX	<b>\$4.11</b>
G1683586	2"	1.55" 3L	1.85" 4L, A, AX	<b>\$4.66</b>
G3184194	4"	3.55" 3L	3.85" 4L, A, AX	<b>\$8.76</b>
G2038373	6"	5.55" 3L	5.85" 4L, A, AX	<b>\$14.32</b>
G0748255	12"	11.55" 3L	11.85" 4L, A, AX	<b>\$28.39</b>

#### 1/4" Bore Diameter

Ⓐ #	OD	belt pitch dia	ax belt pitch dia	price
G2811776	2"	1.55" 3L	1.85" 4L, A, AX	<b>\$4.06</b>
G1373784	4"	3.55" 3L	3.85" 4L, A, AX	<b>\$7.81</b>
G3411922	5"	4.55" 3L	4.85" 4L, A, AX	<b>\$8.62</b>
G2044244	6"	5.55" 3L	5.85" 4L, A, AX	<b>\$12.88</b>
G2599152	12"	11.55" 3L	11.85" 4L, A, AX	<b>\$33.59</b>

#### 5/8" Bore Diameter

Ⓐ #	OD	belt pitch dia	ax belt pitch dia	price
G3333172	3"	2.55" 3L	2.85" 4L, A, AX	<b>\$6.24</b>
G0465735	4"	3.55" 3L	3.85" 4L, A, AX	<b>\$8.19</b>
G3148932	5"	4.55" 3L	4.85" 4L, A, AX	<b>\$12.31</b>
G2544297	6"	5.55" 3L	5.85" 4L, A, AX	<b>\$12.26</b>
G1424202	12"	11.55" 3L	11.85" 4L, A, AX	<b>\$28.39</b>

#### 1" Bore Diameter

Ⓐ #	OD	belt pitch dia	ax belt pitch dia	price
G1724195	3"	2.55" 3L	2.85" 4L, A, AX	<b>\$5.94</b>
G2130292	4"	3.55" 3L	3.85" 4L, A, AX	<b>\$8.18</b>
G2185197	5"	4.55" 3L	4.85" 4L, A, AX	<b>\$11.49</b>
G1415556	6"	5.55" 3L	5.85" 4L, A, AX	<b>\$11.71</b>
G0514333	12"	11.55" 3L	11.85" 4L, A, AX	<b>\$35.46</b>

### FENNER DRIVES Composite Idler Sprockets with Bearing

- Stock bore



Ⓐ #	outer diameter	teeth	chain size	price
G1562531	2.98"	17	ANSI 40-2	<b>\$15.82</b>
G1910063	3.40"	15	ANSI 50-2	<b>\$16.70</b>
G2769137	3.52"	13	ANSI 60-2	<b>\$18.49</b>

### GOODYEAR ENGINEERED PRODUCTS Laser Alignment Tool

- For 60mm or greater sheave diameters

includes (2) magnet targets and (1) AA battery

Ⓐ #	price
G1103216	<b>\$1,082.19</b>



### TB WOOD'S Groove Gauge

- For V-belts and sheaves

Ⓐ #	price
G3650175	<b>\$5.16</b>



### CONGRESS Stepped V-Belt Pulleys

- Fixed bore
- Die cast Zamak 3
- For use with 4L or A type V-belts
- Fits 5/8" or 1/2" shaft

includes set screw and reducer bushing

3 Groove		4 Groove	
Ⓐ #	OD	price	price
G2261007	1.875", 2.5", 3.313"	<b>\$21.80</b>	
G1149547	2", 3", 4"	<b>\$18.91</b>	
G1147404	2", 3", 4", 5"	<b>\$26.26</b>	
G2315862	3", 4", 5", 6"	<b>\$41.48</b>	



### TB WOOD'S Fixed Bore V-Belt Pulleys

- Solid cast iron
- For use with 3L, 4L, A or AX type V-belts

includes set screw

5/8" Bore Diameter					
Ⓐ #	OD	ax belt pitch dia	belt pitch dia	industry #	price
G1211892	1.75"	1.5" 4L, A, AX,	-	AK1758	<b>\$5.06</b>
G0903375	2.05"	1.8" 4L, A, AX	1.46" 3L	AK2058	<b>\$5.06</b>
G1793696	2.25"	2" 4L, A, AX	1.66" 3L	AK2258	<b>\$5.06</b>
G0854621	2.55"	2.3" 4L, A, AX	1.96" 3L	AK2558	<b>\$4.59</b>
G2327227	3.05"	2.8" 4L, A, AX	2.46" 3L	AK3058	<b>\$6.72</b>

#### 3/4" Bore Diameter

Ⓐ #	OD	ax belt pitch dia	belt pitch dia	industry #	price
G2119363	2.05"	1.8" 4L, A, AX	1.46" 3L	AK2034	<b>\$4.72</b>
G0497034	2.25"	2" 4L, A, AX	1.66" 3L	AK2234	<b>\$4.93</b>
G2648536	2.55"	2.3" 4L, A, AX	1.96" 3L	AK2534	<b>\$5.45</b>
G1492057	3.45"	3.2" 4L	2.86" 3L	AK3434	<b>\$7.55</b>
G1048117	7.25"	7" 4L,	6.66" 3L	AK7434	<b>\$17.60</b>

### TSUBAKI Double Strand Sprockets

- Stock bore
- Bushing not required



Ⓐ #	OD	pitch dia	teeth	bore dia	ANSI	price
G2314173	2.328"	2.089"	13	3/4"	40-2	<b>\$33.83</b>
G5778342*	4.522"	4.194"	21	3/4"	50-2	<b>\$71.93</b>
G5498157*	6.387"	5.984"	25	1"	60-2	<b>\$136.51</b>

### GATES Cast Iron Multi-Groove V-Belt Pulleys

- Quick detachable bushed bore
- For 5V or 5VX single or joined type V-belts
- Fits 7/8" to 3 1/2" shaft
- E bushing required

• ■ RMA AND MPTA STANDARDS

#### 3 Groove

Ⓐ #	OD	belt pitch dia	industry #	price
G1438482	14"	13.9" 5V	QD3/SV14.00	<b>\$222.62</b>
G0413761	15"	14.9" 5V	QD3/SV15.00	<b>\$234.56</b>
G2574957	16"	15.9" 5V	QD3/SV16.00	<b>\$240.49</b>

#### 4 Groove

Ⓐ #	OD	belt pitch dia	industry #	price
G0889883	14"	13.9" 5V	QD3/SV14.00	<b>\$289.49</b>
G0432792*	15"	14.9" 5V	QD5/SV15.00	<b>\$458.97</b>
G3011671*	16"	15.9" 5V	QD5/SV16.00	<b>\$483.40</b>





# MACHINE TOOLS & ACCESSORIES

MORE THAN 800,000 ITEMS ONLINE

## DAYTON C-Face Speed Reducers

- Standard duty
- 1750 input rpm
- 5/8" bore
- Forward/reversible rotation
- ■ AGMA STANDARDS



②#	nominal output	overhung load	nominal ratio	max input
G0459094	69 rpm	679 lb	25:1	.75 hp
G0701802	35 rpm	986 lb	50:1	0.5 hp

each **\$483.06**

## DAYTON C-Face Speed Reducers

- Parallel/inline shaft
- 1750 input RPM
- 5/8" bore
- Forward/reversible rotation
- ■ AGMA STANDARDS



②#	nominal output	overhung load	nominal ratio	max input
G0930097	30 rpm	660 lb	57.5:1	.5 hp
G0789004	60 rpm	660 lb	29:1	.5 hp

each **\$641.18**

## SMITH BEARING Stud Cam Followers

- Carbon steel needle roller bearings
- Unsealed
- Screwdriver slot head
- ■ ABMA STANDARDS



②#	roller size	stud length	thread size	thread length	static load capacity	price
G4110811	1.25" d x .75" w	0.5" d x 1.25"	1/2"-20	0.625"	4300 lb	<b>\$16.93</b>
G4161281	0.75" d x 0.5" w	0.375" d x 0.875"	3/8"-24	0.375"	2260 lb	<b>\$10.75</b>
G4323767	1" d x 0.625" w	0.4375" d x 1.0"	3/8"-20	0.5"	3100 lb	<b>\$13.45</b>

## INA Yoke Track Rollers

- 52100 steel rollers and double row bearings
- Cylindrical roller bearings
- Crowned



②#	size	bore	measurement	static load capacity	radial load capacity	price
G0949207	90	50 mm	90 mm d x 32 mm w	36,000 lb	22,500 max	<b>\$184.82</b>
G1115125	62	30 mm	62 mm d x 29 mm w	17,800 lb	13,300 max	<b>\$66.88</b>
G2314085	52	25 mm	52 mm d x 25 mm w	13,500 lb	9800 max	<b>\$82.85</b>

## LOVEJOY Buna N Spider Inserts

- -40° to 212° F
- Accommodates 1° angular and 0.015" of parallel misalignment



②#	max torque	coupling size	rating @ 300 rpm	rating @ 1200 rpm	rating @ 1800 rpm	rating @ 3600 rpm	price
G2233296	144/194 in-lb	A/L090/L095	0.7/0.9 HP	2.8/3.7 HP	4.1/5.5 HP	8.3/11 HP	<b>\$4.49</b>
G3346314	90 in-lb	A/L075	0.4 HP	1.7 HP	2.6 HP	5.0 HP	<b>\$4.87</b>
G0952131	318/417 in-lb	A/L099/L100	2 HP	7.9 HP	12 HP	24 HP	<b>\$8.94</b>
G3123486	792 in-lb	A/L110	3.8 HP	15 HP	23 HP	46 HP	<b>\$12.89</b>

## LOVEJOY S-Flex Shaft Couplings

- For motors, pumps, compressors, blowers, mixers and conveyors
- 1° with EPDM rubber Inserts and 1/4° with H inserts maximum angular misalignment
- One over the key and one at 90° set screw locations



②#	bore	length thru bore	torque	dia hub	rpm	price
G2704177	5/8"	0.880"	120"-lb	1.630"	7600 max	<b>\$8.93</b>
G0278844	1 1/8"	1.310"	450"-lb	2.500"	6000 max	<b>\$16.80</b>
G1423536	5/8"	0.81"	60"-lb	1.500"	9200 max	<b>\$5.53</b>

## LOVEJOY Shaft Coupling Inserts

- General purpose
- EPDM rubber
- -30° to 275° F operating temperature



②#	body style	OD	torque	rpm	price
G2591443	6JE	3.75"	450"-lb	6000 max	<b>\$11.41</b>
G0445322	4JE	2.31"	120"-lb	7600 max	<b>\$6.39</b>
G0508602	3JE	1.88"	60"-lb	9200 max	<b>\$3.62</b>

## DUFF-NORTON 12VDC Linear Actuators

- 500 lb rated load
- 42"/min speed @ rated Load
- 18% duty cycle
- 50° C/120° F
- 11 full load amps
- ■ AGMA STANDARDS



②#	stroke length	retracted length	price
G0961974	6"	14 3/4"	<b>\$361.06</b>
G2514836	12"	20 3/4"	<b>\$463.77</b>

## DUFF-NORTON 115 VAC Linear Actuators

- 675 lb rated load
- 16"/min speed @ rated load
- 17% duty cycle
- 50° C/120° F
- 1.6 full load amps



②#	stroke length	retracted length	price
G0494234	12"	19 1/2"	<b>\$220.32</b>
G1329912	24"	31 1/2"	<b>\$217.90</b>

## DUFF-NORTON 115 VAC Linear Actuators

- 1500 lb rated load
- 50"/min speed @ rated load
- 17% duty cycle
- 50° C/120° F
- 6.5 full load amps



②#	stroke length	retracted length	price
G1848585	6"	20"	<b>\$1,103.60</b>
G0601842	12"	26"	<b>\$1,070.78</b>

## LOVEJOY Jaw Coupling Hubs

- Sintered iron
- Keyways



②#	size	OD	length	bore	price
G3079946	L075	1.75"	2.13"	3/8"	<b>\$3.78</b>
G1969301	L075	1.75"	2.13"	3/4"	<b>\$5.29</b>
G2692383	L095	2.11"	2.51"	3/4"	<b>\$13.43</b>
G3028277	L095	2.11"	2.51"	1"	<b>\$13.43</b>
G0384605	L075	1.75"	2.13"	5/8"	<b>\$6.42</b>
G2018615	L075	1.75"	2.13"	5/8"	<b>\$5.29</b>
G1884364	L050	1.08"	1.71"	3/2"	<b>\$2.45</b>

## THOMSON Linear Bearing Shafts

- Carbon steel
- Unhardened
- 8 Ra max finish



②#	diameter	length	price
G0572975	20 mm	1000 mm	<b>\$27.83</b>
G1524616	25 mm	400 mm	<b>\$24.16</b>
G0429396	30 mm	1500 mm	<b>\$66.49</b>

## DAYTON Shaft Collars

- Zinc plated steel
- Alloy steel set screw



②#	bore dia	OD	width	screw	price
G1998376	1/2"	1"	3/16"	1/4"-20	<b>\$3.46</b>
G1180584	3/4"	1 1/4"	3/16"	5/16"-18	<b>\$4.78</b>
G2975201	1"	1 3/4"	3/8"	5/16"-18	<b>\$5.54</b>

**INA Needle Roller Thrust Bearings**

- Steel cage
- Axial direction
- -5° to +250°F
- Oil lubrication
- 0.078" h

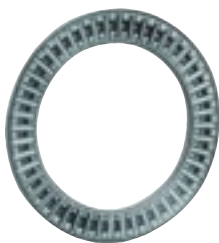

#	bore dia	OD	max rpm	dynamic load	static load	price
G3257107	0.250"	0.687"	20,000	1370 lb	3000 lb	<b>\$2.33</b>
G2130633	0.500"	0.937"	13,000	1920 lb	5300 lb	<b>\$2.70</b>
G2948172	1.000"	1.562"	7500	3150 lb	12,100 lb	<b>\$2.81</b>
G0806793	1.500"	2.187"	5000	4850 lb	23,700 lb	<b>\$3.81</b>
G2440216	2.000"	2.750"	4000	5800 lb	32,500 lb	<b>\$3.82</b>

**NTN Sealed Radial Ball Bearings**

- Pressed steel cage
- Synthetic rubber seal molded to a steel plate
- -20° to 250°F
- SRI#2 grease lubrication



#	bore dia	OD	width	dynamic load	static load	price
G2576165	10mm	26mm	8mm	1030 lb	440 lb	<b>\$9.23</b>
G1399991	17mm	40mm	12mm	2160 lb	1030 lb	<b>\$7.95</b>
G3280006	20mm	47mm	14mm	2890 lb	1500 lb	<b>\$8.70</b>
G2248057	25mm	52mm	15mm	3150 lb	1770 lb	<b>\$9.23</b>
G1391467	30mm	62mm	16mm	4400 lb	2540 lb	<b>\$14.93</b>

**DAYTON Heavy Duty Ball Bearing Mandrel**

- For jackshafts
  - Die-cast housing
  - Prelubricated and sealed setscrew-type ball bearing
  - 5/8" x 12" driveshaft
  - 3000 max rpm
  - 2" OD pulley
  - Requires A or 4L belt
- includes hex nut and (2) machined flange washers (1 1/2") for each end*



#	price
G1198346	<b>\$68.81</b>

**NTN Shielded Radial Ball Bearings**

- Pressed steel cage
- Rust-resistant metal shield
- -20° to 250°F
- SRI #2 grease lubrication



#	bore dia	outer diameter	width	dynamic load	static load	price
G0638626	10mm	30mm	9mm	1150 lb	540 lb	<b>\$4.26</b>
G3258306	17mm	40mm	12mm	2160 lb	1030 lb	<b>\$7.33</b>
G1466717	20mm	47mm	14mm	2890 lb	1500 lb	<b>\$5.72</b>
G1252054	25mm	52mm	15mm	3150 lb	1770 lb	<b>\$7.32</b>
G3004084	30mm	62mm	16mm	4400 lb	2540 lb	<b>\$16.68</b>

**DAYTON Series PBS-BL Pillow Block Bearings**

- Pressed steel housing
  - Rust proof plated finish
  - Ball bearing insert
  - -30° to 200°F
- includes (2) set screws and oil resistant rubber liner*



#	bore dia	dynamic load	static load	dimensions
G1135145	1/2"	2152 lb	1075	1 3/16" w x 4 3/16" l x 2 3/8" h
G1237433	3/8"	2152 lb	1075	1 3/16" w x 4 3/16" l x 2 3/8" h
G0542211	3/4"	2877 lb	1497	1 9/16" w x 4 3/16" l x 2 3/8" h
G2917652	1"	3153 lb	1768	1 7/8" w x 4 3/16" l x 2 3/8" h

each **\$16.73**

**DAYTON Closed Ball Bushing Bearings**

- For linear motion shafts
- Stainless steel/polymer cage
- 5000 in/min steady state speed
- +/- .0004 inside diameter tolerance
- 0° to 176°F temp range



#	bore dia	OD	tolerance	static load	length	price
G0608535	0.250"	0.5000"	+/- .00045	60 lb	.75"	<b>\$16.19</b>
G1689536	0.500"	0.8750"	+/- .00050	176 lb	1.25"	<b>\$17.07</b>
G0617346	0.750"	1.250"	+/- .0004	308 lb	1.625"	<b>\$20.32</b>
G3170623	1.000"	1.563"	+/- .00065	353 lb	2.250"	<b>\$37.52</b>

**BUNTING BEARINGS Flanged Sleeve Bearings**

- Powdered metal bronze SAE 841
- 50,000 max Pv
- 10° to 220°F
- SAE 30 oil lubrication
- 3 pack



#	ID	OD	length	flange diameter	flange thickness	price
G4058731	3/16"	7/16"	3/4"	3/16"	3/16"	<b>\$2.91</b>
G4149975	1/4"	3/8"	3/4"	1/2"	3/16"	<b>\$5.67</b>
G4081831	3/8"	1/2"	1/2"	1 3/16"	3/16"	<b>\$2.54</b>
G4323146	1/2"	5/8"	3/8"	3/8"	3/8"	<b>\$2.70</b>
G3962323	5/8"	3/4"	5/8"	1"	3/8"	<b>\$4.34</b>

**BESSEY Cone Bearing Heaters**

- 120 V
  - 725 W
- includes 250° F temperature indicator crayon*



#	ID bearing range	size	price
G3166721	3/8" to 5 3/4"	9" x 10"	<b>\$364.40</b>

*includes automatic temperature regulation preset @ 250° F*

#	ID bearing range	size	price
G0978582	3/4" to 8"	12" x 10"	<b>\$692.18</b>

**BESSEY Bearing Heaters**

- 120 V**
- 7" w x 11 1/2" l x 9" h
  - includes 3/4" and 2" crossbars*
- | #        | max bearing OD | bearing width | price             |
|----------|----------------|---------------|-------------------|
| G2051962 | 11"            | 4"            | <b>\$1,252.71</b> |

- 220 V**
- 8" w x 17" l x 16" h
  - includes 1 3/4" and 3" crossbars*
- | #        | max bearing OD | bearing width | price             |
|----------|----------------|---------------|-------------------|
| G0494566 | 22"            | 7 1/2"        | <b>\$2,490.97</b> |





## MACHINE TOOLS & ACCESSORIES

### INNOVATIVE COMPONENTS

#### Ball Lock Pin

- 17-4 stainless steel with plain finish
- Positive locking pin knob
- Button handle
- ½" pin dia
- 3½" grip length



Z#	price
G1388685	<b>\$54.07</b>

### INNOVATIVE COMPONENTS

#### Spring Plunger Pin

- Zinc plated steel
- knob style
- ⅜-16 thread
- ¼" plunger dia
- ⅞" l tip



Z#	price
G3427033	<b>\$10.50</b>

### INNOVATIVE COMPONENTS

#### Pop Pins

- Zinc plated steel
- Weld on barrels
- Rounded T-knob
- ½" tip dia
- 1" barrel dia

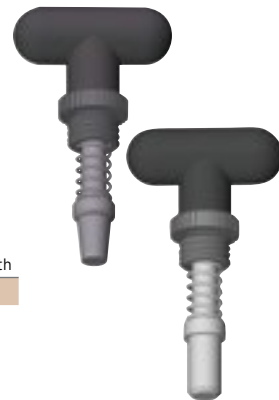

Z#	tip	tip length	each
G2909776	tapered	0.61"	<b>\$7.90</b>
G0974163	straight	0.86"	

### DAVIES Four Prong Knob

- High gloss HR phenolic clamp knob
- Blind tap
- ¼-20 coarse thread
- 1.5" dia with 0.625" base dia
- 1" length



Z#	price
G1251871	<b>\$1.43</b>

### INNOVATIVE COMPONENTS

#### Three Prong Knob

- Scratch resistant black polypropylene knob with zinc plated steel insert
- Thru tap, ¼-20 thread
- 1.25" dia with 0.625" base dia
- 1" l



Z#	price
G0342291	<b>\$1.10</b>

### KIPP Mini Wing Knob

- Thermoplastic and steel with matte finish
- Novo grip
- ¼-20 external thread
- 0.78" l screw
- 1.38" l overall



Z#	price
G1696956	<b>\$1.09</b>

### INNOVATIVE COMPONENTS Star Knob

- Scratch resistant black polypropylene knob with zinc plated steel insert
- Star style with screw
- ⅜-16 thread
- 2¼" knob dia
- 1" base dia



Z#	price
G1145252	<b>\$0.79</b>

### INNOVATIVE COMPONENTS T-Knob

- Scratch resistant black polypropylene knob with zinc plated steel insert
- Thru tap, ¼-20 thread
- 2" knob dia
- ¾" base dia



Z#	price
G0286194	<b>\$0.69</b>

### INNOVATIVE COMPONENTS Ball Knob

- Scratch resistant black polypropylene knob with zinc plated steel insert
- Blind tap
- ⅝-18 thread
- 1¼" dia, 0.625" base dia
- 1⅞" l



Z#	price
G1419801	<b>\$0.74</b>

### INNOVATIVE COMPONENTS Knurled Knob

- Scratch resistant nylon plastic construction with steel zinc insert
- Blind tap
- 10-24 thread
- 1" knob with ⅝" base



Z#	price
G2883815	<b>\$0.99</b>

### DAVIES Skirted Control Knob

- High gloss GP phenolic knob
  - ¼" bushing brass thread
  - Blind tap with ¼" thread
  - 1½" dia
  - Heat resistant up to 450°F
- includes pad print and cup point set screw*



Z#	price
G2348656	<b>\$2.67</b>

### TE-CO T-Slot Nuts

- Carbon steel with black oxide finish
- Last thread incomplete to prevent stud from turning through the bottom of the nut
- Undersized to fit machine table slot



Z#	thread	table slot	base	price
G0818684	⅜-16"	⅜"	⅞"	<b>\$2.63</b>
G1777921	⅜-16"	⅝"	⅞"	<b>\$2.52</b>
G1858631	½-13"	⅝"	1⅞"	<b>\$2.98</b>
G1805711	½-13"	⅝"	1⅞"	<b>\$3.19</b>

### PRECISION BRAND Shim Stock Assortments

- For general shimming and maintenance applications
- 6" x 12" Sheets of varying thickness
- Lot numbers printed on every sheet
- ▶ MORE AVAILABLE ONLINE

#### 260 Alloy Brass

Z#	pieces	thickness range	price
G1218174	12	0.001" - 0.015"	<b>\$30.69</b>
G2608216	15	0.001" - 0.031"	<b>\$46.19</b>

#### Low Carbon Steel

Z#	pieces	thickness range	price
G2361877	12	0.001" - 0.015"	<b>\$26.75</b>
G1585297	15	0.001" - 0.031"	<b>\$37.11</b>



### JACOBS Wedge Sets

- Used to remove taper mount chucks from arbors

Z#	used on	each
G3481597	1JT	<b>\$6.49</b>
G0301454	2JT	
G0565573	3JT	
G1714474	6JT	





**WESTWARD Chucking Reamer Set**

- High speed steel reamer with straight flute and bright finish
- Right-hand cut
- Through hole reamer includes sizes ranging from 1/16 to 1/2"

#	price
G4134155	<b>\$235.10</b>



15  
PIECE

**WIDIA METAL REMOVAL Carbide Bur Set**

- Double-cut carbide burs
- 1/4" shank
- includes (8) pieces SA-1, SC-1, SD-1, SE-1, SF-1, SG-1, SL-1, SM-2

#	price
G1167424	<b>\$129.85</b>



8  
PIECE

**ALDEN Drill/Extractor Set**

- High carbon steel
- For removing #4 to #24 screws, #10 to 3/8" bolts (5 to 10mm)
- One end self-centering drill tip
- Other end serrated extractor

#	price
G0662277	<b>\$19.34</b>



4  
PIECE

**ALDEN Drill/Extractor Set**

- High carbon steel
- For removing #6 to #14 screws, bolts #5 and #6 to 1/2" (3 to 12mm)
- Double-ended and power extractor bits of varying sizes

#	price
G2602731	<b>\$61.07</b>



10  
PIECE

**HUOT Original Fractional Tap Dispenser**

- Steel and vinyl construction
- Holds sizes 1/4"-20 through 1"-12
- 3-drawer design with 26 compartments
- 14 5/8" w x 7 3/8" d x 7 3/4" h
- Cutting tools not included

#	price
G1172202	<b>\$67.90</b>



**JACOBS Chuck Keys**

- Soft steel construction reduces risk of fracture
- Nickel thumb grip handles for increased leverage and user comfort

#	key size	pivot size	price
G2435614	K30	1 5/64"	<b>\$4.70</b>
G2452554	K3	5/16"	<b>\$5.84</b>
G3447656	K3C	5/16"	<b>\$6.88</b>
G1166934	K4	3/8"	<b>\$9.70</b>

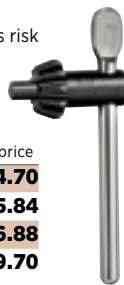

**WESTWARD Metric Chucking Reamers**

- High speed steel reamer with a round shank and bright finish
- 6 flutes, 1 1/2" l
- Right-hand cut
- 45° chamfer

#	size	price
G4148146	7 mm	<b>\$13.58</b>
G4044397	8 mm	



**WESTWARD Construction Reamer**

- High speed steel reamer with hex nut shank and black oxide finish
- Use to ream, true, enlarge, align, and debur holes in structural steel
- Tapered ends with left-hand spiral and right-hand cut
- 1 3/16" large end dia, 1 1/4" shank dia
- 7 3/8" flute length, 9 3/8" overall length

#	price
G4163862	<b>\$74.91</b>



**WESTWARD Adjustable Hand Reamer**

- High speed steel reamer with straight shank and black oxide finish
- 1 5/32 to 1 7/32" fractional size
- 5 1/2" overall length

#	price
G3319337	<b>\$21.79</b>



**CHICAGO-LATROBE Screw Extractor Set**

- Heat treated high carbon steel
- For removing studs, bolts, and screws 3/16" to 1", and 1/8" pipe
- Tapered left-hand spiral flutes
- includes #1, through #6 and plastic pouch

#	price
G1698137	<b>\$23.92</b>



6  
PIECE

**JACOBS Drill Chucks**

- Steel construction
- 33JT Jacobs mount

- Keyless**
- For portable and stationary drilling machines

#	capacity	chuck dia	price
G1364693	0.039" to 0.512"	1.73"	<b>\$85.73</b>



**Keyed**

- Bench top & floor mounted power tools

#	capacity	chuck dia	price
G2578606	0.04"-0.50" max	2.04"	<b>\$69.88</b>



**DRILL DOCTOR**

**Home Workshop Drill Bit Sharpener**

- Sharpens and restores dull bits, 118° sharpening angle
- Diamond 180 grit wheel sharpens standard twist, HSS, cobalt, carbide, TiN and masonry bits
- 110 V, 1.75 A, 1/2 HP, 20,000 max rpm

- ■ UL LISTED
- includes 3/32" to 1/2" chuck

#	price
G1519253	<b>\$49.89</b>



**DRILL DOCTOR**

**Professional Drill Bit Sharpener**

- Sharpens dull or broken bits, 115° to 140° sharpening angle
- Diamond 180 grit wheel sharpens standard and split point twist, HSS, cobalt, carbide, TiN and masonry bits
- 110 V, 1.75 A, 1/2 HP, 20,000 max rpm

- ■ UL LISTED
- includes 3/32" to 1/2" chuck and hard case

#	price
G3056566	<b>\$135.39</b>



**IRWIN HANSON Screw Extractor Set**

- Multi-spline high carbon steel extractors
- For removing studs, bolts, and screws 1/8" to 7/8"
- Heat treated and tempered for long life
- Left-hand spiral design
- includes 1/8"-7/8" extractors

#	price
G0837426	<b>\$54.39</b>



25  
PIECE

**HUOT Drill Dispensers**

- Jobber length drill dispensers
- Steel and vinyl construction
- Cutting tools not included

**Original Dispenser**

- 14 5/8" w x 7 3/8" d x 7 3/4" h

#	type	design/compartments	holds	price
G1408163	letter size	3-drawer, 26	A to Z	<b>\$69.85</b>
G1502207	fractional	3-drawer, 29	1/16" to 1/2" by 64ths	<b>\$65.85</b>
G1619965	wire gauge	5-drawer, 60	1 to 60 wire gauge	<b>\$79.85</b>



**Master Dispenser**

#	dimensions	design/compartments	holds	price
G2160024	26" w x 12" d x 12 3/4" h	4-drawer, 159	1 to 60 wire gauge & A to Z 1/16" to 1/2" by 64ths,	<b>\$367.45</b>



MORE THAN 800,000 ITEMS ONLINE

# MACHINE TOOLS & ACCESSORIES

## DAYTON MILL/DRILL MACHINE

- Cast iron mill/drill provides accurate milling, drilling and boring capabilities
- Fine feed handwheel with .001 graduations and quill lock
- Enclosed R8 spindle
- ¾ motor HP, 1 phase, 115/230V
- 16" swing, 14" clearance

**#** price  
**G1545512 \$1,971.25**



## DAYTON Milling Machine Starter Kit

- R8 series
- For use with mills, mill/drills, and large drill presses

*includes a (10) piece (4) flute HSS end mill kit with case, R8 collet rack, (11) R8 collets, 2" boring head, accepts ½" boring bars and (1) ⅝" drill chuck with R8 arbor*

**#** price  
**G2165046 \$597.60**

**29**  
PIECE



## CENTAUR R8 Series Collet

- For use with milling/drilling machines
- ⅜" size

**#** price  
**G2406503 \$22.50**



## CENTAUR ER 32 Series Collet

- High-grade, hardened, precision-ground spring steel
- For use with collet chucks
- ¼" size

**#** price  
**G3179653 \$26.97**



## TE-CO Tapped End Clamp

- For single-point clamping
- Tapped hole in end for supporting stud
- 1¼" x 4", ⅝" thick
- ½" slot size

**#** price  
**G2329896 \$12.96**



## TE-CO Machinist Clamping Kit

- For work holding during machining applications
- Use with ½-13 stud size
- ⅝ T-slots

*includes (24) studs, (4) coupling nuts, (6) flange nuts, (6) T-slot nuts, (1) T-slot cleaner, (6) step blocks, (6) serrated end clamps and (1) holder*

**#** price  
**G1647037 \$92.21**



## PALMGREN Bench Vise Slip Roll Kit

- For use with any 5" or larger bench vise
- 3 precision-ground adjustable rollers
- Bending and rolling wire ½" to ⅜"

• 20 gauge max  
 • 17" x 25" x 5½"  
*includes adjusting screws with scales and grooved roller*

**#** price  
**G2496094 \$264.25**



## DE-STA-CO Pneumatic Clamps

- Toggle-action clamps remain in locked position if air pressure is lost or hoses disconnected
- Steel
- -14° to 195° F operating temp
- 80 psi max input

#	holding capacity	base mounting center	price
G1612694	200 lb	1.06" x 0.50"	\$107.06
G2427975	375 lb	1.25" x 0.75"	\$115.24



## DE-STA-CO Toggle Clamps

- Straight-line action clamps replace fasteners for secure holding of parts on fixtures
- Lock in both extended and retracted positions to provide holding force in "pull" or "push" directions

#	holding capacity	plunger	handle	length	price
G3310081	100 lb	0.63" travel, 0.25" dia	thumb with vinyl grip	2.61"	\$9.93
G0812323	300 lb	1.5" travel, 0.44 dia	straight with ergonomic grip	4.95"	\$12.93
G2683581	600 lb	1.25" travel, 0.44" dia	straight with ergonomic grip	4.73"	\$16.45
G2058804	2500 lb	2" travel, 0.62" dia	straight with ergonomic grip	7.06"	\$39.47



## DAYTON Drill Press Vise

- Can be turned on either side or set on end for use
- 4" jaw width, 4" jaw opening
- Fixed Base, parallel to 0.001"
- 0.002" jaw deflection at 2000 lbs

**#** price  
**G0889926 \$63.12**



## DAYTON Standard Drill Vise

- Precision-ground guide bars provide smooth, accurate travel and clamping
- ½" wide slotted shoulder, fixed base
- 6" jaw width, 6" jaw opening, 2" throat depth
- 0.002" jaw deflection at 2000 lbs

**#** price  
**G0323723 \$123.26**

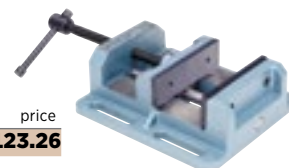

## PALMGREN Low Profile Machining Vise

- Hold workpiece between a stationary jaw and a moveable jaw
- 4½" jaw width, 4" jaw opening, 1¼" throat depth
- 0.002" jaw deflection at 4000 lbs,
- 0.002" jaw plate, 0.001" bed/base
- 12½" l x 2⅝" h

**#** price  
**G1635164 \$239.24**



## DAYTON Cross Vise

- Cross and longitudinal handle rotates above machine table surface
- Fixed base
- 8" jaw width, 8" jaw opening, 2" throat depth 0.002" jaw deflection at 2000 lbs
- 16½" l x 7¼" h

**#** price  
**G2026805 \$308.35**

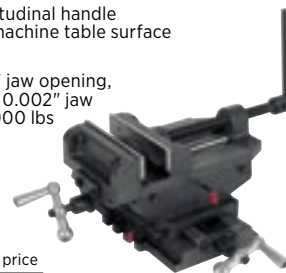

### JET Lathe

- Optimally designed speed ranges
- 3 speeds
- 60-3600 RPM
- 3/8" spindle bore
- 1 HP Motor, single phase
- 115V, 60Hz
- Acme thread in tailstock, MT-2 tailstock taper
- Innovative ratchet style belt tension system
- 11" w x 33 3/4" l x 17-78" h



# price  
G6205114 **\$897.65**

### ADVANTAGE PLUS Lathe Tool Bit Set

- Single point, brazed carbide tipped
- Suitable for machining a wide range of ferrous and non-ferrous materials
- 3/8" shank capacity

11  
PIECE



# price  
G4458544 **\$56.68**

### WESTWARD Lathe Guards

- Clear, semi-circular wrap-around guards are easy to mount
- includes mounting brackets, extension tube and hardware*



#	for chucks	dimensions	price
G1586471	6" to 12"	6" w x 12" l x 6" h	<b>\$148.78</b>
G2378616	12" to 16"	8" w x 16" l x 8" h	<b>\$169.74</b>
G2417877	16" to 20"	8" w x 20" l x 10" h	<b>\$194.22</b>

### WESTWARD Safety Shield

- For use with C-clamp
  - Features quick cam action, and 360° swivel locking shield
  - 6" w x 8" l, 1/8" thick
  - 14" long including flexible arm
- includes C-clamp, flexible arm and shield*



# price  
G2885337 **\$75.49**

### DAYTON Portable Dust Collector

- Single stage, high-efficiency dust collector
- Not suitable for aluminum or other reactive dust, or hot metal dust
- 4" intake hose, and 40 gal drum capacity
- 550 cfm (max), 3/4 HP, 115/230V, 7.5 A



# price  
G3359562 **\$246.30**

### DORIAN Tool Holders

- For turning and facing
- For CNC and manual lathes

#### SDN 25 AXA Series

- Use with AXA tool post
- Capacity 3/4"

# price  
G2184506 **\$57.13**



#### SDN 25 BXA Series

- Use with BXA tool post
- Capacity 1"

# price  
G0905527 **\$61.72**



### MASON Leveling Mount

- Neoprene construction
- 500 lbs max steady load
- 3 1/2" dia, 1 1/8" h
- 3/2" bolt

# price  
G2084993 **\$26.35**



### MASON Vibration Isolation Pad

- Pad features a cemented steel plate between a bottom super waffle pad and top 1/4" friction pad
- Neoprene and steel construction
- Protects isolating vibration with 3600 and 1750 rpm pumps and refrigeration compressors
- 800 lb steady load (max)
- 4" w x 4" l x 1 1/4" h

# price  
G2279121 **\$8.57**



### ABANAKI Disk Skimmer

- Oil skimmer removes unwanted floating oils from coolants and parts washer
  - Polymer housing will not corrode
  - 12" disk prevents warping
  - Removes up to 1 1/2 gph
  - 110V fan-cooled gearmotor, 7 rpm, 4" reach
- includes sealed motor shaft, boomerang blades, disk, motor and wheel*

# price  
G1509925 **\$183.11**



### VALUE BRAND Cylindrical Vibration Isolator

- Isolator is compression-mounted to control noise, vibration, and shock
- Rubber pads are bonded to steel with superior abrasion resistance and high tensile strength
- Clear zinc plated grade 5 screws
- 3/4" h, 1/2" thread length, 1/4-20 thread size

# price  
G2859647 **\$1.59**



### MASON Floor Mount Vibration Isolator

- Neoprene bottom eliminates the need for bolting to floor
- 15 to 45 lb capacity
- 1 5/8" x 1 1/2"
- Screws size 3/16" dia x 3/4" l *includes top bolts and washers*

# price  
G2843547 **\$10.49**



### MASON Spring Floor Mount Vibration Isolator

- Nonskid pads reduce need for bolting to floors
- Sponge rubber guides improve stability
- 130 to 200 lb capacity, 0.75" to 1.15" deflection
- 3/8" x 4" bolt
- 2 1/8" x 4 1/2"

# price  
G1213055 **\$33.95**



### MASON Seismic Floor Mount Vibration Isolator

- Combines spring floor-mount vibration isolators and neoprene vertical limit stops for greater safety
- G ratings meet the horizontal requirements of most seismic zones
- 130 to 200 lb capacity
- 0.75" to 1.15" deflection
- 2 1/2" x 5 1/2"

# price  
G1350587 **\$103.11**



### MASON Hanger Mount Vibration Isolator

- Steel springs reduce vibration transmission
- 3/8" rod dia (max), 3 1/2" lower rod penetration
- Rubber bushing
- 0.75" to 1.02" deflection
- 55 to 76 lb capacity

# price  
G1640624 **\$15.49**



### MASON Hanger Mount Vibration Isolator

- Steel springs reduce vibration transmission
- 3/8" rod dia (max), 3 1/2" lower rod penetration
- Rubber bushing
- 80 to 113 lb capacity
- 0.75" to 1.00" deflection

# price  
G1735623 **\$22.38**





# PNEUMATICS

## INGERSOLL-RAND Tank-Mounted Electric Air Compressor

- 3 HP, 135 psi, 230 V
- 23" w x 20" l x 66" h
- 60 gal tank
- OSHA, UL, CSA, ASME STANDARDS

includes precision bearing  
**#** price  
 G1775776 **\$699.29**



**Start-Up Kit**  
 includes lubricant, (2) inlet air filters and product data sheet

**#** price  
 G1179437 **\$32.39**



## INGERSOLL-RAND Vertical 2 Stage Electric Air Compressor

- 5 HP, 175 psi, 230 V
- 30" w x 32" l x 69" h
- 60 gal tank
- ASME STANDARDS

**#** price  
 G2426672 **\$1,287.74**



## CAMPBELL HAUSFELD 2 Stage Electric Air Compressor

- 5 HP, 175 psi, 230 V
- 41" w x 31" l x 78" h
- 80 gal tank
- ASME, CSA STANDARDS, CALIFORNIA CODE 462 (L)(2)

**#** price  
 G0772161 **\$1,087.75**



## SPEEDAIRE Twin Stack Electric Air Compressor

- 1.3 HP, 125 psi, 115 VAC
- 18 5/8" w x 19 5/8" l x 17 5/8" h
- 4 gal tank
- CSA STANDARDS

**#** price  
 G4259306 **\$310.84**



## THOMAS Oil-Less Piston Air Compressor

- 1/10 HP, 12VDC
- 100/100 max psi cont/int
- 4 1/4" w x 7 1/2" l x 5 1/2" h
- 1/8" NPT inlet, 1/4" NPT outlet
- 63 dBA @ 60 psi

**#** price  
 G0626832 **\$385.86**



## THOMAS INDUSTRIES Piston Air Compressor

- 12VDC
- 120 max psi cont/int
- 1" w x 5 1/2" l x 5 1/4" h
- 5/8" OD tube
- 60 dBA

**#** price  
 G2179572 **\$165.07**



## INGERSOLL-RAND Compressor Coolant

- PAG-Ester base
- 5L can
- 10W-20 SAE grade
- 100 ISO viscosity grade
- 172 viscosity index

**#** price  
 G3061633 **\$166.63**



## PORTER CABLE Portable Electric Air Compressors

- 0.8 HP
- 115 VAC
- 6 gal tank
- 150 psi
- 18 3/8" w x 18" l x 15" h
- ISO STANDARDS

**#** price  
 G1842574 **\$181.57**



## THOMAS Ultra Air-Pac Portable Electric Air Compressor

- 0.5 HP, 125 psi, 115 VAC
- 8" w x 16 1/2" l x 15 1/2" h
- 2 gal tank
- UL STANDARDS

**#** price  
 G2426015 **\$494.99**



## SPEEDAIRE Portable Tankless Tire Inflator

- 0.9 HP, 115 psi, 115 VAC
- 9 1/8" w x 15 3/4" l x 14 1/4" h
- UL, CSA STANDARDS

includes hose, regulator, quick connect plug, pressure gage, chuck and manifold

**#** price  
 G4862374 **\$133.63**



## INGERSOLL-RAND All Season Select Compressor Oil

- Synthetic
- 1L bottle

**#** price  
 G2911063 **\$19.92**



## INGERSOLL-RAND 2 Stage Tank-Mounted Electric Air Compressor

- 7 1/2 HP, 175 psi, 230 V
- 28" w x 37" l x 70" h
- 80 gal tank
- CALIFORNIA CODE 462(L)(2)

**#** price  
 G2885382 **\$2,198.54**

**Start-Up Kit**  
 includes lubricant, (2) inlet air filters and product data sheet

**#** price  
 G2300146 **\$80.01**



## INGERSOLL-RAND Stationary Air Compressor

- 13 HP, 175 psi
- 33" w x 57" l x 44" h
- 30 gal tank
- CA CODES

**#** price  
 G2839076 **\$2,699.99**



**Start-Up Kit**  
 includes lubricant, (2) Inlet air filters and product data sheet

**#** price  
 G2257123 **\$178.93**





**SPEEDAIRE  
Small Steel Air Receivers**  
• 175 psi

**3 Gallon Tank**

Item #	size	diameter	price
G1833921	25" x 8"	6"	<b>\$233.65</b>

**10 Gallon Tank**

• ASME U CODE

Item #	size	diameter	price
G0901731	24½" x 14"	12"	<b>\$318.31</b>

**SPEEDAIRE  
Portable 13 Gauge  
Steel Air Tank**

- 5 gal
  - 125 psi
  - 10" w x 17½" l x 11½" h
  - 9½" tank diameter
- includes hose shut off valve



Item #	price
G2405277	<b>\$43.12</b>

**CDI CONTROL DEVICES  
Carry Tank Manifold**

- 20 cfm
  - ½" tank mount
  - 150 psi
  - 3½" w x 3½" d x 4" h
- features safety valve, outlet valve, filler valve, tank mount fitting and air gauge fitting

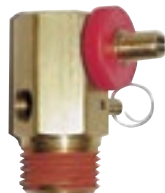

Item #	price
G1838837	<b>\$11.77</b>

**LEGACY  
Air Tank Valve**

- Brass
- ½" MNPT

Item #	price
G2531934	<b>\$1.45</b>

**CDI CONTROL DEVICES  
Brass Air Tank Valve**

- ½" NPT
- 150 psi

Item #	price
G3225826	<b>\$3.14</b>

**SPEEDAIRE  
Stationary Steel Air Tank**

- 60 gal
- 200 psi
- 35.8" shell
- 20" diameter
- 52" height
- ASME U CODE

Item #	price
G2587532	<b>\$863.20</b>



**SPEEDAIRE  
5½ HP Dual-Tank Wheelbarrow  
Gas Engine Air Compressor Tank**

- 8 gal
  - 150 psi
  - 13 gauge steel
  - 21" w x 47½" l x 11¼" h
  - 6" tank diameter
- includes (1) ½" NPT, (2) ¼" NPT and (2) ¼" NPT drain ports



Item #	price
G0415484	<b>\$596.36</b>

**SPEEDAIRE  
3 HP Portable ASME Code Air Tank**

- 20 gal
- 144 psi
- 12 gauge steel
- 15½" w x 33½" l x 18¼" h
- 14" tank diameter
- ¼", ⅜" and ½" NPT ports

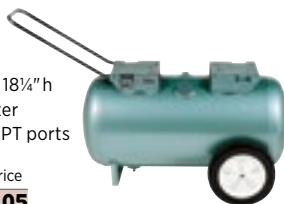

Item #	price
G0564103	<b>\$372.05</b>

**SPEEDAIRE  
Horizontal  
Stationary  
Steel Air Tank**

- 6 gal
- 175 psi
- 20" x 12"
- 10" diameter
- ASME U CODE

Item #	price
G3373684	<b>\$289.88</b>



**SPEEDAIRE  
Non-Coded Steel Air Tanks**

- 125 psi
  - 1 HP
- includes ¼" and ½" NPT ports and ¼" drain port



**3 Gallon Tank**

- 13 gauge
- 8½" w x 25" l x 8¼" h
- 5⅝" diameter

Item #	price
G0621442	<b>\$175.34</b>



**5 Gallon Tank**

- 11 gauge
- 16½" w x 24½" l x 14¼" h
- 16½" diameter

Item #	price
G2988474	<b>\$179.70</b>

**SPEEDAIRE Portable Steel Air Tanks**

- 12" tank diameter



**11 Gallon Tank**

- 125 psi
  - 10 gauge
  - 12¼" w x 24¼" l x 14¾" h
- includes (1) ½" NPT port, 0 to 60 psi gauge, brass manifold with shutoff and safety valve and 3' hose with adapter

Item #	price
G1536035	<b>\$87.15</b>



**13 Gallon Tank**

- 140 psi
  - 13 gauge
  - 12½" w x 28½" l x 16¼" h
- includes (2) ½" NPT, ¼" NPT drain port and ¼" safety valve port

Item #	price
G2297321	<b>\$250.04</b>

**SPEEDAIRE  
20 Gallon Portable Carry Tank**

- 144 psi
  - 15 gauge steel
  - 12½" w x 31½" l x 18½" h
  - 14" tank diameter
- includes ASME safety valve

Item #	price
G0483104	<b>\$396.12</b>

**Tank Conversion Kit**

includes shut off valve, hose, gauge and tire chuck

Item #	price
G2324253	<b>\$47.97</b>





# PNEUMATICS

MORE THAN 800,000 ITEMS ONLINE

### GAST Diaphragm Compressor/Vacuum Pump

- 1/8 HP, 115V
- 60 Hz, 4.2A
- 1/4" inlet/outlet size
- 25.5 max vacuum
- 5 1/8" w x 7 3/8" l x 7 1/16" h

Z# price  
**G1860293 \$397.94**



### GAST Rotary Vane Compressor/Vacuum Pump

- 3/4 HP, 115/230V
- 50/60 Hz, 12.2/6.1A
- 3/8" NPT inlet/outlet size
- 26" Hg max vacuum
- 6.5" w x 15.94" l x 8.34" h

Z# price  
**G2484045 \$673.27**



### INGERSOLL-RAND 2 Stage Air Compressor Pump

- 5, 7 1/2, 10 HP
- 175 psi
- 3/4" NPT outlet
- 500, 825, 1050 pump rpm
- 27 5/8" w x 25 1/16" d x 20 1/16" h

Z# price  
**G2397753 \$2,093.14**



### INGERSOLL-RAND Compressed Air Dryer

- 7.5 HP, 25 cfm
  - 203 psi, 115VAC
  - 15 3/8" w x 18" d x 18" h
  - ISO class 6
- includes electronic auto drain*

Z# price  
**G0553445 \$1,014.00**



### CENTURY Air Compressor Motor

- 5 HP, 230V
- 60 Hz, 22A
- 2 1/4" shaft, 14 1/2" overall
- 7/8" shaft diameter
- 3001-3600 RPM range

Z# price  
**G2752136 \$266.06**



### GAST Air Gearmotor

- 0.31 HP, 2 cfm
- 80 psi
- 1/8" NPT port
- 400 max rpm
- 2.93" w x 7.30" l x 2.93" h

Z# price  
**G0903953 \$460.12**



### WILKERSON Combination Unit

- Filter, regulator, lubricator
- 150 psi, 100 cfm
- 5 microns
- 1/2" NPT pipe size
- 1/4" NPT gauge port
- Manual drain
- 9.32" x 9.36"

Z# price  
**G2062977 \$161.99**



### SPEEDAIRE Disposable Air Filter/Dryer

- 125 psi
- 1/4" FNPT inlet, 1/4" MNPT outlet
- 40 microns
- 3 3/4" length
- 1 1/16" diameter
- 2 pack

Z# price  
**G1191942 \$19.79**



### GAST Compressor/Vacuum Pump Repair Kit

*includes (4) vanes, O-ring, gasket, gasket bolt and filter felt*

Z# price  
**G1077623 \$116.74**

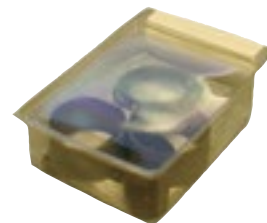

### WILKERSON Desiccant Air Driers

- Silica gel

#### Desiccant Air Dryers

- 150 psi
- 1/4" FNPT inlet, 1/4" MNPT outlet
- ISO class 2

Z#	style	cfm	dimensions	price
G0641864	x06	5	3" w x 6 7/8" l x 6 1/2" h	<b>\$55.00</b>
G0780071	x03	10	4 1/8" w x 13 3/8" l x 13 3/8" h	<b>\$108.99</b>

#### Replacement Desiccants

Z#	refills	for use with	cu-ft	price
G1477016	3	x06 dryer	600	<b>\$25.30</b>
G3484503	4	x03 dryer	4,400	<b>\$189.99</b>



### GAST Rotary Vane Air Motor

- 1.8 HP, 78 cfm
- 100 psi
- 1/4" NPT port
- 3000 max rpm
- 4.31" w x 5.81" l x 4.06" h

Z# price  
**G2816737 \$207.02**



### Repair Kit

*includes vanes, bearings, gaskets, springs, pins and seal*

Z# price  
**G2798406 \$118.34**



**SPEEDAIRE**  
**Pneumatic Exhaust Mufflers**

- 300 psi
- 40 microns
- Sintered bronze with nickel plated steel fitting
- Reduce exhaust noise levels to acceptable OSHA requirements



Q#	port	hex	length	price
G2437285	3/8" NPT	3/8"	1 1/8"	\$2.64
G1066791	1/4" NPT	3/8"	1 3/8"	\$2.95
G0628704	3/8" NPT	1 1/8"	1 1/2"	\$3.78
G1298866	1/2" NPT	7/8"	1 7/8"	\$4.55

**SPEEDAIRE**  
**Speed Control Mufflers**

- 300 psi
- 40 microns
- Bronze with brass fitting
- Reduces noise



Q#	port	hex	length	price
G3379074	1/8" NPT	1/2"	1 1/8"	\$5.27
G2061604	1/4" NPT	9/16"	1 1/8"	\$5.79
G3059822	3/8" NPT	1 1/8"	1 3/8"	\$7.48

**SPEEDAIRE**  
**Heavy Duty Air Regulator**

- Aluminum
- 1" NPT pipe size and gauge port
- 480 cfm
- 450 psi
- 175° F max
- 5.98" x 9.71"



Q#	price
G1094852	\$133.84



**ARO**  
**Filter/Regulator**

- 173 cfm, 250 psi
- 5 microns
- 1/2" NPT pipe size
- 1/8" NPT gauge port
- 2.76" x 10.03"
- includes panel nut and gauge*



Q#	price
G1102692	\$76.89

**WILKERSON**  
**Mini Air Regulator**

- 300 psi
- 22 cfm
- 1/4" NPT pipe size
- 1/8" NPT gauge port
- 125° F max
- 1.65" x 3.14"



Q#	price
G1544697	\$14.43

**SPEEDAIRE**  
**Air Regulators**

- 300 psi
- Balanced valve design
- Nonrising adjustment knob

Q#	pipe size (NPT)	gauge port (NPT)	cfm	size	price
G1800976	3/8"	3/8"	440	4.25" x 7.26"	\$21.54
G0700271	1/4"	3/8"	15	4.25" x 2.91"	\$21.54
G1642067	1/2"	3/4"	220	3.15" x 6.67"	\$43.20
G1220152	1/2"	3/4"	220	3.15" x 6.67"	\$67.06

**ARO**  
**Solenoid Air Control Valves**

- 4-way, 2-position
- 50 to 150 psi
- 29" Hg
- 0 to 180° F
- ■ NEMA 4



**No Coil - 1/4"**

Q#	cfm	dimensions	price
G1245982	50	1 3/16" w x 2 3/16" l x 3 3/4" h	\$59.80

**120 VAC Coil - 1/4"**

Q#	cfm	dimensions	price
G0651612	50	1 3/16" w x 3 1/2" l x 3 3/4" h	\$67.14

**120 VAC Coil - 3/8"**

Q#	cfm	dimensions	price
G1510695	61	2 3/8" w x 3 3/8" l x 3 3/8" h	\$103.25

**ARO**  
**Solenoid Air Control Valve**

- 12 VDC, 1/8" pipe size
- 0 to 120 psi, 6.9 cfm
- 3-way, 2-position
- 1" w x 1 1/4" l x 2 1/2" h
- ■ NEMA 4



Q#	price
G1419713	\$30.98

**ARO**  
**Flow Control Valves**

- 200 psi
- 200° F max
- Calibrated adjustment knob
- Glass reinforced thermoplastic with zinc plated steel pipe port inserts



Q#	port (NPT)	price
G2722675	3/8"	\$19.88
G0673215	1/4"	\$21.52
G0853106	3/8"	\$24.50
G2072375	1/2"	\$26.62

**WILKERSON**  
**Automatic Drain Valve**

- 30 to 200 psi
- 1/4" drain outlet diameter
- 3/8" NPT pipe size
- 2 1/8" w x 2 1/16" d x 3 1/16" h



Q#	price
G2634651	\$66.69

**CDI CONTROL DEVICES**  
**Adjustable Relief Valve**

- 25 to 200 psi
- 250° F max
- 1/4" MNPT inlet
- Brass with rubber seal and stainless steel spring



Q#	price
G2334114	\$7.11

**WEKSLER**  
**Brass Needle Valve**

- 600 psi @ 300° F
- 1/4" NPT inlet and outlet



Q#	price
G2061911	\$11.41

**INTECH**  
**Timed Electric Auto Drain Valve**

- 230 psi, 50/60 Hz
- 115 V, 4 A
- 1/4" drain, 8.8 gpm
- 1/4" NPT pipe size
- 1 7/8" w x 3 1/4" d x 4 3/16" h
- ■ NEMA 4
- includes strainer and 6' cord*



Q#	price
G2925596	\$92.24



# PNEUMATICS



### SPEEDAIRE Polyurethane Coiled Air Hoses

- 1/4" inside hose diameter
- 1/4" NPT
- Male rigid x male swivel connectors
- 3:1 safety factor

Z#	hose length	price
G1139214	6'	<b>\$22.33</b>
G2180981	10'	<b>\$25.69</b>
G1497291	15'	<b>\$30.13</b>
G3368906	20'	<b>\$36.77</b>
G0974023	30'	<b>\$50.09</b>

### SPEEDAIRE Nylon Coiled Air Hoses

- Male rigid x male swivel connectors

12' Hose					
Z#	psi	inside hose dia	NPT	price	
G3262682	185	3/4"	3/4"	<b>\$16.69</b>	
G2497406	165	3/8"	3/8"	<b>\$28.39</b>	
G1360274	170	1/2"	1/2"	<b>\$41.75</b>	
25' Hose					
Z#	psi	inside hose dia	NPT	price	
G1414007	185	3/4"	3/4"	<b>\$20.05</b>	
G0363246	165	3/8"	3/8"	<b>\$40.92</b>	
G3194475	170	1/2"	1/2"	<b>\$59.64</b>	

### LINCOLN General Industrial Hose Reel

- 300 psi
  - 1/2" FNPT reel inlet and 1/2" MNPT npt hose ends
  - 8-position, self locking latch
  - 9" w x 20" l x 22" h
- includes bare hose reel, 50' delivery hose and ball stop*



Z#	price
G0353184	<b>\$139.71</b>

### REELCRAFT Premium Industrial Hose Reel

- 300 psi
  - 3/8" FNPT reel inlet and 1/4" MNPT x 3/8" MNPT hoe ends
  - Vibration proof, self locking latch
  - 6" w x 16 1/2" l x 17 1/2" h
- includes 50' hose*



Z#	price
G1496363	<b>\$251.99</b>

### OETIKER 81 Piece Hose Clamp Assortment

- Stepless 1 Ear
- Stainless steel
- 8 sizes

*includes 10 each of 3/8", 1/2", 3/4", 1", 1 1/4", 1 1/2" standard jaw pincer and plastic case*



Z#	price
G3201432	<b>\$42.71</b>

### IDEAL Interlocked Worm Gear Hose Clamps

- Stainless steel
- 35 in/lb torque
- 3/16" wide band
- 3/16" screw size
- 10 pack



Z#	clamp diameter	SAE number	price
G1311791	3/8" to 1/2", 10mm to 22mm	6	each <b>\$6.08</b>
G3357541	1/2" to 1 1/8", 13mm to 27mm	10	

### VALUE BRAND Brass Hose Mender

- 300 psi
- 3/8" barb size
- Crimped or hose clamp type



Z#	price
G0609375	<b>\$0.85</b>

### SPEEDAIRE Industrial Coupler Plugs and Bodies

- 300 psi
- 1/4" body and pipe sizes
- NBR seal
- Zinc plated steel

- Plugs**
- ■ ISO, MIL STANDARDS

Z#	connection	price
G4869216	MNPT	<b>\$2.05</b>
G4869191	FNPT	<b>\$2.10</b>



- Bodies**
- 35 cfm

Z#	connection	price
G4869356	MNPT	each <b>\$7.53</b>
G4882814	FNPT	



### SPEEDAIRE Multipurpose Air Hoses

- 3/8" inside diameter
- 0.687" outside diameter
- 4:1 safety factor
- Nitrile oil resistant



#### Red — 250 psi

Z#	MNPT fitting	hose length	RMA class	price
G0536891	3/4"	50'	C	<b>\$58.35</b>
G1923686	1/4"	25'	C	<b>\$32.33</b>
G0737606	3/8"	50'	A	<b>\$64.45</b>
G1508516	3/8"	25'	A	<b>\$34.49</b>

#### Yellow — 300 psi

Z#	MNPT fitting	hose length	RMA class	price
G1649024	3/8"	50'	A	<b>\$71.46</b>

### VALUE BRAND Straight Brass Hose Barbs

- 300 psi
- 3/8" barb size



Z#	NPT fitting	hex head	price
G2969626	1/4" (M)	3/16"	<b>\$0.79</b>
G0633787	3/8" (M)	1 1/16"	<b>\$0.99</b>
G1727135	1/4" (F)	1 1/16"	<b>\$1.09</b>
G2942091	3/8" (F)	1 3/16"	<b>\$1.49</b>

### AMFLO Industrial Quick Coupler/Plug Kit

- 300 psi
- 1/4" body and pipe sizes
- FNPT connection
- Brass

*includes FNPT coupler and MNPT plug*



Z#	price
G1346396	<b>\$5.89</b>

### ARO Solenoid Coil Connectors

- 12 VDC, 24 VDC, 120 VAC, and 240 VAC
- For use with 1/8" 22mm connector valves
- Strain relief
- ■ NEMA 4

Z#	lead	price
G2698577	none	<b>\$9.23</b>
G3043257	36"	<b>\$12.76</b>







**BRECO In Line Air Guns**

- 1/4" FNPT inlet, 1/8" FNPT outlet
- 150 psi max inlet pressure
- 95 psi output

1/2" Nozzle  
• 5 1/4" long

#	max dBA	scfm	price
G2934364	89	20	<b>\$5.59</b>
G0683995	89.5	17.5	<b>\$5.89</b>

3/4" Nozzle  
• 4 1/2" long

#	max dBA	scfm	price
G1413431	85	5	<b>\$5.55</b>



**LEGACY Pistol Grip Air Guns**

- 1/4" FNPT inlet, 1/8" FNPT outlet
- 120 psi max inlet pressure
- 90 psi output
- 87 max dBA
- 13 scfm
- OSHA STANDARDS

#	nozzle length	price
G0482501	1 1/2" 7 1/2"	<b>\$7.85</b>
G1204271	12" 17"	<b>\$11.99</b>



**DYNA-CON 12" Bendable Air Gun Nozzle and Extension**

- 1/8" MNPT inlet
- Brass base with copper tube
- For use with airlines regulated to 30 psi or less
- OSHA STANDARDS

#	price
G3211336	<b>\$17.43</b>



**GUARDAIR Venturi Nozzle Air Guns**

- 1/4" FNPT inlet, 1/8" FNPT outlet
- 120 psi
- 34 scfm
- 107 max dBA
- OSHA STANDARDS

#	extension	lbf output	length	price
G1004516	12"	2	16"	<b>\$24.30</b>
G1225253	24"	2	28"	<b>\$25.35</b>
G3326154	36"	2.1	40"	<b>\$26.40</b>



**BRECO Heavy Duty Air Gun Kit**

includes heavy-duty air gun, high flow safety nozzle, 6" extension safety nozzle, rubber tip nozzle, needle tip nozzle, air screen safety nozzle and clear vinyl storage pouch

#	price
G2995921	<b>\$25.99</b>

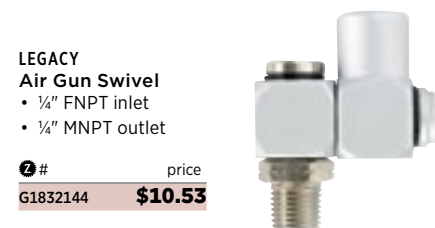

**LEGACY Air Gun Swivel**

- 1/4" FNPT inlet
- 1/4" MNPT outlet

#	price
G1832144	<b>\$10.53</b>



**WESTWARD Air Gun Kit**

includes plastic and metal air gun with quick-change adapter, safety booster tip, 1/2" industrial male plug, inflating tip, siphon tip, plastic tip, rubber tip, 2", 3" and 4" needle tips, 6" safety extension nozzle and blow-molded case

#	price
G1511501	<b>\$39.09</b>

**WESTWARD Standard Non-Safety Nozzle Air Gun**

- 1/4" FNPT inlet, 1/8" outlet
- 220 psi max inlet pressure, 90 psi output
- 9 scfm, 90 max dBA
- 10" long
- includes 4" nozzle

#	price
G1944634	<b>\$22.29</b>

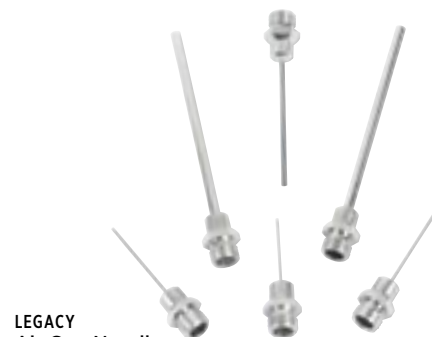

**LEGACY Air Gun Needle Nozzle Kit**

- Stainless steel
- 1/8" MNPT inlet

#	price
G1605362	<b>\$3.79</b>

**WILKERSON Aluminum Inline Air Lubricator**

- 200 psi
- 36 cfm
- 0.25 oz oil capacity
- 1/4" NPT
- 1.30" w x 1.12" l x 2.93" h

#	price
G2619653	<b>\$20.93</b>



**POP Industrial Air Riveter**

- 85 psi, 1,000lb pulling force
- 0.008 cfm, 1/8" NPT
- 1/8", 5/32", and 3/32" blind rivet diameter
- 6 1/16" x 9 5/8", 4 1/2" diameter
- includes jaw and jaw pusher spring

#	price
G3198282	<b>\$443.75</b>



**CHICAGO PNEUMATIC General Duty Air Riveter**

- 90 psi, 2,110lb pulling force
- 1 cfm, 1/4" NPT
- 1/8", 5/32", 3/32", and 7/16" blind rivet diameter
- 8 3/16" x 6 1/2", 3/8" diameter
- includes (4) nosepieces 3/32", 1/8", 5/32", 3/16" and twist off cup for storage

#	price
G4981435	<b>\$137.79</b>





# PNEUMATICS



### CAULK MASTER Pneumatic Caulk Guns

- ¼" NPT
- 0 to 70 psi
- 3' hose
- Twist lock retainer
- For use with low and medium viscosity materials like sealants, caulk and adhesives

Item #	cartridge	price
G0894397	10 oz	<b>\$47.33</b>
G0643474	10.3 oz & 30 oz	<b>\$72.52</b>



### INGERSOLL-RAND Pistol Grip Air Impact Wrenches

- 9800 rpm, 90 psi
- 50 to 550 ft/lb torque range, 780 ft/lb max torque
- ½" square drive, ⅝" max bolt capacity
- ¼" NPT, ⅜" min hose size
- 7½" long

Item #	duty	price
G1278331	general	<b>\$298.00</b>
G0974741	industrial	<b>\$312.00</b>

### WESTWARD Light Duty Air Impact Wrench

- 10,000 rpm, 90 psi
- 5 to 50 ft/lb torque range, 75 ft/lb max torque
- ⅜" square drive and max bolt capacity
- ¼" NPT, ⅜" min hose size
- 6½" long

Item #	price
G3294986	<b>\$83.03</b>



### INGERSOLL-RAND General Duty Air Impact Wrench

- 8000 rpm, 90 psi
- 15 to 160 ft/lb torque range, 200 ft/lb max torque
- ⅜" square drive, ⅝" max bolt capacity
- ¼" NPT, ⅜" min hose size
- 7½" long

Item #	price
G2833327	<b>\$152.75</b>

### INGERSOLL-RAND Air Ratchet Wrenches

- 90 psi
- ⅜" square drive
- ¼" NPT, ⅜" min hose size

#### General Duty - 160 rpm

Item #	torque range	max torque	length	head	price
G1287081	10 to 45 ft/lb	54 ft/lb	11"	1½" x 1⅜"	<b>\$90.02</b>

#### Industrial Duty - 200 rpm

Item #	torque range	max torque	length	head	price
G1558882	10 to 60 ft/lb	65 ft/lb	10¾"	2" x 1⅜"	<b>\$145.89</b>



### CHICAGO PNEUMATIC Air Impact Wrench

- 9500 rpm, 90 psi
- 5 to 65 ft/lb torque range, 90 ft/lb max torque
- ⅜" square drive and max bolt capacity
- ¼" NPT, ⅜" min hose size
- 6½" long

Item #	price
G3620346	<b>\$136.59</b>



### WESTWARD Light Duty Air Ratchet Wrenches

- 150 rpm, 90 psi
- ¼" NPT, ⅜" min hose size

#### ⅜" Square Drive

Item #	torque range	max torque	length	head	price
G1221202	10 to 50 ft/lb	50 ft/lb	10½"	1¾" x 1⅜"	<b>\$72.75</b>

#### ½" Square Drive

Item #	torque range	max torque	length	head	price
G1800626	10 to 75 ft/lb	90 ft/lb	14"	2" x 1⅜"	<b>\$130.10</b>



### INGERSOLL-RAND General Duty Air Nibbler

- 3200 strokes per minute
- 90 psi
- 18 gauge
- ¼" NPT, ⅜" min hose size
- 7½" long

Item #	price
G3239555	<b>\$110.24</b>



**13**  
PIECE



### INGERSOLL-RAND Impact Hex Socket Set

- SAE
- ½" square drive
- 6 pt deep
- includes ⅜", ½", ⅝", ⅞", 1", 1¼", 1½", 1¾", 2", 2¼", 2½", 2¾", 3", 3½", 4", 4½", 5", 5½", 6", 6½", 7", 7½", 8", 9", 10"

Item #	price
G0341135	<b>\$51.39</b>

**11**  
PIECE

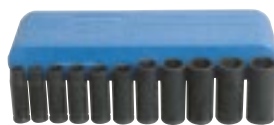

### WESTWARD Impact Socket Set

- SAE
- ½" drive
- 6 pt deep
- includes ½", ⅝", ⅞", 1", 1¼", 1½", 1¾", 2", 2¼", 2½", 2¾", 3", 3½", 4", 4½", 5", 5½", 6", 6½", 7", 7½", 8", 9", 10"

Item #	price
G3432396	<b>\$83.54</b>



### CHICAGO PNEUMATIC Industrial Air Nibbler

- 2750 strokes per minute
- 90 psi
- 16 gauge
- ¼" NPT, ⅜" min hose size
- 8½" long

Item #	price
G3618903	<b>\$226.25</b>



**CHICAGO PNEUMATIC  
Pistol Style  
Air Drills**

- 3/8" chuck size
  - 90 psi
  - 1/4" NPT, 3/8" min hose size
- includes chuck key

**General Duty**

#	rpm	HP	length	price
G3666704	2000	1/2	6 1/2"	\$109.66

**Industrial Duty**

#	rpm	HP	length	price
G3673153	4200	1/2	7"	\$200.25



**INGERSOLL-RAND  
General Duty Air Drills**

- 3/8" chuck size
- 2000 rpm
- 1/2 HP, 90 psi
- 1/4" NPT, 3/8" min hose size
- Pistol style

**Keyed**

includes chuck key

#	length	price
G1946953	6 5/8"	\$117.85

**Keyless**

#	length	price
G1748467	6 1/2"	\$124.84



**WESTWARD  
Light Duty Air Drills**

- 1/2 HP
- 90 psi
- 1/4" NPT, 3/8" min hose size
- Keyed
- Pistol style

#	rpm	chuck	length	price
G3106117	2000	3/8"	7 3/4"	\$65.53
G0841181	500	1/2"	9"	\$105.20



**INGERSOLL-RAND  
General Duty Pistol Style Air Drill**

- 1/2" chuck size
- 500 rpm
- 1/2 HP, 90 psi
- 1/4" NPT, 3/8" min hose size
- 8 7/8" long

#	price
G1981831	\$186.35

**INGERSOLL-RAND  
Industrial Air Hammer**

- 3000 blows per minute
- 90 psi
- 0.401" shank
- 1/4" NPT, 3/8" min hose size
- 7 3/8" long

#	price
G1692871	\$156.02



**WESTWARD  
Spring Retainer**

- 0.401" shank
- Beehive style
- For use with 0.401" shank pneumatic hammers

#	price
G1372856	\$6.86



**INGERSOLL-RAND  
Air Hammer Kits**

- 0.401" shank
- 1/4" NPT, 3/8" min hose size
- Pistol style handle

**General Duty**

- 3000 blows per minute
  - 90 psi
  - 7 7/8" long
- includes hammer, (6) chisels and plastic case

#	price
G2777205	\$98.18



**Industrial Duty**

- 2500 blows per minute
- 105 psi
- 10 1/2" long

includes tool, quick change retainer, (5) chisels, blow-molded case and manuals

#	price
G4970734	\$140.94



**INGERSOLL-RAND  
Industrial Reversible  
Air Screwdriver**

- 900 rpm, 90 psi
- 13 to 70 in/lb torque range soft draw
- 1/4" NPT, 1/4" min hose size
- 9 1/2" long, 1/4" hex bit

#	price
G1495496	\$615.44

**WESTWARD  
Alloy Steel Flat Rivet Chisel**

- 0.401" shank
- Round collar
- 3/4" tip width
- 6 1/2" long

#	price
G2739825	\$11.78



**INGERSOLL-RAND  
General Duty Reversible  
Pneumatic Screwdriver**

- 1800 rpm, 90 psi
- 47.1 to 115 in/lb torque range soft draw
- 1/4" NPT, 3/8" min hose size
- 7 1/4" long, 1/4" hex bit

#	price
G1643537	\$111.28



**VALUE BRAND Rivet Clinchers**

- Manual
- Steel

#	application
G2887814	1/8" diameter rivets
G0394992	3/16" diameter rivets

each \$33.14



**INGERSOLL-RAND  
Industrial Reversible  
Pneumatic Screwdriver**

- 1000 rpm, 90 psi
  - 2.7 to 30.1 in/lb torque range soft draw
  - 1/8" NPT, 1/4" min hose size
  - 8 3/4" long, 1/4" quick change hex bit
- includes extra clutch springs

#	price
G0627462	\$529.19





# PNEUMATICS



**CHICAGO PNEUMATIC  
Right Angle General Duty  
Air Die Grinder**

- 22,500 rpm
- 0.3 HP, 90 psi
- ¼" NPT, ⅜" min hose size
- 4 7/8" long

*includes wrenches*

Z#	price
G3712965	<b>\$54.11</b>



**CHICAGO PNEUMATIC  
General Duty Air Pencil Grinder**

- 60,000 rpm
- 0.05 HP, 90 psi
- ¼" NPT, ⅜" min hose size
- 5 1/2" long

Z#	price
G3650367	<b>\$100.32</b>



**INGERSOLL-RAND  
Industrial Air Pencil Grinder**

- 60,000 rpm
- 0.10 HP, 90 psi
- ¼" NPT, ¼" min hose size
- 5 3/8" long

Z#	price
G2454085	<b>\$292.15</b>



**SPEEDAIRE  
Industrial Air  
Die Grinder**

- 20,000 rpm
- 0.39 HP, 90 psi
- ¼" NPT, ⅜" min hose size
- 5 1/8" long

*includes (2) collet wrenches*

Z#	price
G4856415	<b>\$68.25</b>



**CHICAGO PNEUMATIC  
Industrial Straight Air Die Grinder**

- 24,000 rpm
- 0.5 HP, 90 psi
- ¼" NPT, ⅜" min hose size
- 5 3/4" long

*includes wrenches*

Z#	price
G3657446	<b>\$130.98</b>



**INGERSOLL-RAND  
Right Angle  
Industrial Air  
Die Grinder**

- 20,000 rpm
- 0.4 HP, 90 psi
- ¼" NPT, ⅜" min hose size
- 7" long

*includes tool, (2) wrenches, 6 mm collet, piped away exhaust kit, service clamp block and manuals*

Z#	price
G4863065	<b>\$150.00</b>



**SKIL  
120 V  
Angle Grinder**

- 11,000 no load rpm
- 6A
- ⅝"-11 spindle thread
- 13 7/8" long
- 8' cord

*features tool-free guard change, side-handle, wrench storage and heavy-duty metal gear housings*

Z#	price
G4938875	<b>\$32.93</b>



**INGERSOLL-RAND  
Industrial Air  
Disc Sander**

- 18,000 rpm
- 7 1/8" - 20 spindle size
- 90 psi
- 7/8" arbor hole
- ¼" NPT, ⅜" min hose size
- 4 3/8" long

*includes (1) 3" and (1) 5" backing pads*

Z#	price
G0872453	<b>\$64.26</b>



**WESTWARD  
Air Random  
Orbital Sander**

- 18,000 rpm
- 7 1/8" - 20 spindle size
- 0.50 HP, 90 psi
- ¼" NPT, ⅜" min hose size
- 5 3/4" long

*includes 3", 4 3/8" and 5 3/8" backing discs*

Z#	price
G1461494	<b>\$42.25</b>



**DYNABRADE  
Air Random Orbital Sanders**

- 12,000 rpm
- ⅝" - 24 spindle size
- 90 psi
- ⅝" orbit diameter
- ¼" NPT, ¼" min hose size

Z#	HP	length	price
G3730063	0.25	7"	<b>\$157.33</b>
G3639894	0.26	6 1/2"	<b>\$168.56</b>
G3631546	0.28	6 1/2"	<b>\$167.79</b>



**INGERSOLL-RAND  
Air Dual-Action Sander**

- 12,000 rpm
- ⅝" - 24 spindle size
- 0.25 HP, 90 psi
- ¼" NPT, ⅜" min hose size
- 10" long

*includes built-in regulator and 6" foam backed pad*

Z#	price
G2517837	<b>\$55.56</b>



**DYNABRADE  
Industrial Air  
Belt Sander**

- 20,000 rpm
- 0.5 HP, 90 psi
- ¼" NPT, ¼" min hose size
- ⅝" to 1 1/2" x 24" belt
- 14 5/8" long

Z#	price
G3606827	<b>\$440.26</b>

**WESTWARD  
Light Duty Air Cut Off Tool Kit**

- 22,000 rpm
- 0.5 HP, 90 psi
- ¼" NPT, ⅜" min hose size
- 7 1/4" long

*includes (8) cut-off wheels and durable plastic case*

Z#	price
G1901776	<b>\$74.12</b>



**BOSTITCH  
16 Gauge Air Staplers**

- 70 to 100 psi
- 160 magazine capacity
- ¼" NPT

Q #	crown	leg length	cfm per shot	dimensions	price
G3380946	1"	½" - 1½"	0.022	3" w x 14½" l x 8¾" h	<b>\$403.50</b>
G3191185	½"	1"-2"	0.028	3" w x 14¾" l x 10¾" h	<b>\$443.79</b>



**BOSTITCH  
Medium Duty Air  
Plier-Type Staplers**

- ½" crown
- ¾" to 5/8" leg length
- 30 to 55 psi
- 1" high throat
- ¼" NPT
- 2½" w x 14¼" l x 10" h

Q #	staple capacity	price
G3121727	104	<b>\$418.56</b>
G3327782	168	<b>\$446.04</b>



**BOSTITCH  
Staples**

- Chisel point
- ½" crown
- Galvanized steel
- 16 gauge

Q #	length	package	price
G2910713	1¾"	11,400	<b>\$86.68</b>
G2237094	1½"	14,250	<b>\$95.91</b>
G1233766	2"	11,400	<b>\$96.21</b>



**BOSTITCH  
Chisel Point Staples**

- 1" crown
- 1½" long
- Galvanized steel
- 16 gauge
- 7,500 pack

Q #	price
G2587611	<b>\$52.40</b>

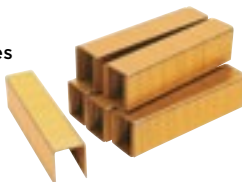

**SENCO  
18 Gauge Straight  
Air Brad Nailer**

- 70 to 120 psi, 1.92 cfm per shot
- 5/8" to 2½" fastener range
- 110 magazine capacity
- ¼" NPT
- 2¼" w x 9¼" l x 10" h

Q #	price
G4973096	<b>\$156.72</b>



**VIBCO  
Turbine Pneumatic Vibrators**

- Continuous duty
- 80 psi max

**VS Series**

- 270 lb force rating
- 2,700 lb bin weight capacity
- ¼" NPT
- 3¼" w x 5¼" l x 3¼" h

Q #	price
G1359802	<b>\$189.41</b>



**VS Series**

- 600 lb force rating
- 6,000 lb bin weight capacity
- ¾" NPT
- 4" w x 5½" l x 4¾" h

Q #	price
G0373947	<b>\$151.43</b>



**VS Series**

- 75 lb force rating
- 750 lb bin weight capacity
- ½" NPT
- 2" w x 4¾" l x 2¾" h

Q #	price
G1898041	<b>\$122.64</b>



**BVS Series**

- 75 lb force rating
- 750 lb bin weight capacity
- ½" NPT inlet, ¼" NPT outlet
- 1¾" w x 4¾" l x 2¾" h

Q #	price
G3191133	<b>\$126.42</b>



**PASLODE  
Flat 16 Gauge Cordless  
Finish Nailer Kit**

- 7.4V
- ¾" to 2½" fastener range
- 110 magazine capacity
- 3½" w x 11¼" l x 12½" h

*includes 120 volt charger, battery, reversible belt hook, 1 No Mar Tip, safety glasses and carrying case*

Q #	price
G2507452	<b>\$295.21</b>



**BOSTITCH  
Air Impact Nailer Kit**

- 70 to 100 psi
- 2 to 4 cfm per shot
- 5D to 70D gauge
- ¼" male air inlet
- 3½" w x 4" l x 5¼" h

*includes standard, finish and large bore nose, leather glove, nose wrench, tool lubricant, spare O-rings and carrying case*

Q #	price
G1190707	<b>\$120.13</b>



**INGERSOLL-RAND Air Tool 50W Oil**

- 1 pt bottle
- For use with grinders, impact wrenches, hoists and winches

Q #	price
G3238496	<b>\$6.52</b>



**INGERSOLL-RAND Air Tool 10W Oil**

- 4 oz bottle
- For use with percussive, assembly, and impact wrenches

Q #	price
G1369636	<b>\$3.62</b>



**PASLODE  
Full Round Angled  
Air Framing Nailer**

- 90 to 120 psi, 0.082 cfm per shot
- 2" to 3½" fastener range
- 74 magazine capacity
- ¼" male air inlet
- 5" w x 19" l x 13½" h

Q #	price
G1368132	<b>\$298.64</b>



**BOSTITCH  
Air Pin Nailer Kit**

- 70 to 100 psi
- 0.018 cfm per shot
- ½" to 1¾" fastener range
- 200 magazine capacity
- 1½" w x 9½" l x 7¾" h
- ¼" male air inlet

*includes (500) ½" pins, (500) ¾" pins, (500) 1" pins and carrying case*

Q #	price
G1795717	<b>\$133.62</b>



**CM SHOPAIR  
Air Chain Hoist**

- 600 lb capacity
- 10', 0 to 16 fpm lift
- 90 psi, 34 scfm
- ¾" NPT
- 5½" w x 12²⁷⁄₃₂" h

*includes standard overload clutch and (2) reduction gearing*

Q #	price
G2505422	<b>\$1,586.74</b>



## HYDRAULICS

### MILLER FLUID POWER

#### Compact Double Acting Hydraulic Cylinder

- Aluminum body material
- Aluminum piston
- 165°F max temp

Q#	bore dia	stroke	SAE port size	retract	max psi pressure	price
G0362223	20mm	25mm	#2	79mm	2030	<b>\$297.43</b>
G0257503	20mm	50mm	#2	104mm	2030	<b>\$334.85</b>
G1376925	40mm	50mm	#4	118mm	2030	<b>\$457.39</b>
G1324653	40mm	80mm	#4	148mm	2030	<b>\$507.62</b>
G0873293	50mm	25mm	#4	99mm	1740	<b>\$500.68</b>
G1037346	50mm	80mm	#4	154mm	1740	<b>\$613.13</b>



#### MAXIM Double Acting Tie Rod Hydraulic Cylinders

- Ductile iron piston
  - High tensile strength piston rod
  - Precision honed steel tubes
  - Polypak rod seal
  - 2500 psi max
- includes pins and clips*



Q#	bore dia	stroke	retract	port size	price
G0340015	2"	12"	22¾"	¾" NPT	<b>\$119.06</b>
G2139322	2"	48"	58¾"	¾" NPT	<b>\$179.32</b>
G2675522	3"	36"	46¾"	½" NPT	<b>\$180.42</b>
G2193301	4"	24"	34½"	½" NPT	<b>\$187.04</b>

### MAXIM

#### Double Acting Welded Hydraulic Cylinders

- Ductile iron piston
- High tensile strength piston rod
- Temp range -20°F to 200°F
- 1½" bore dia
- ¾" pin dia
- 3000 max pressure psi



Q#	stroke	retract	price
G0803214	4"	12"	<b>\$80.49</b>
G3299791	6"	14"	<b>\$91.25</b>
G1259894	8"	16"	<b>\$94.37</b>
G2785194	10"	18"	<b>\$97.45</b>
G3121535	12"	20"	<b>\$108.05</b>

### ENERPAC

#### Single Acting Hydraulic Cylinders

- Steel body
  - 10,000 psi max
- includes coupler and dust cap*

#### Flat Jack Cylinder

Q#	weight capacity	stroke length	oil capacity	retracted height	plunger dia	price
G1853582	20 ton	7/8"	1.94 cu-in	2.03"	2"	<b>\$645.85</b>



#### Low Height Cylinder

Q#	weight capacity	stroke length	oil capacity	retracted height	plunger dia	price
G1082067	10 ton	1½"	3.35 cu-in	3.47"	1.50"	<b>\$385.95</b>
G0787071	30 ton	2½"	15.82 cu-in	4.63"	2.62"	<b>\$645.15</b>
G2193152	100 ton	2¼"	44.18 cu-in	5.56"	3.63"	<b>\$1,164.50</b>



#### Standard Steel Cylinder

Q#	weight capacity	stroke length	oil capacity	retracted height	plunger dia	price
G0641645	10 ton	2½"	4.75 cu-in	4.78"	1.50"	<b>\$322.15</b>
G2690371	50 ton	6¼"	69.03 cu-in	11.13"	3.13"	<b>\$1,109.25</b>

### PRINCE

#### Double Acting Welded Hydraulic Cylinders

- Ductile iron piston
- Polished chrome piston rod
- Cast iron ring
- Heavy-wall honed steel tubes
- Urethane U-cup rod seal

Q#	bore dia	stroke	rod dia	retract	max psi pressure	price
G3395226	2½"	8"	1¾"	16"	2500	<b>\$156.75</b>
G1327286	2½"	24"	1¾"	32"	2500	<b>\$276.35</b>
G3181543	3"	30"	1¾"	38"	1839	<b>\$283.12</b>
G1214437	3"	36"	1¾"	44"	2500	<b>\$329.64</b>
G2168582	4"	16"	2"	25"	2500	<b>\$342.49</b>
G2233174	4"	30"	2"	39"	2500	<b>\$347.65</b>



### ENERPAC

#### Threaded Single Acting Hydraulic Cylinders

- Steel construction
  - Single acting
  - 8800 lb capacity at 5000 psi
- includes mounting bolts and arm c-clip*

Q#	retracted height	stroke	price
G1571385	2.94"	.51"	<b>\$201.26</b>
G1891477	3.71"	.98"	<b>\$210.97</b>



### ENERPAC

#### Threaded Double Acting Hydraulic Cylinders

- Steel construction
- Polyurethane/Buna N seal material
- 3900 lb capacity at 5000 psi
- 580 to 5000 psi

Q#	capacity@ 5000 psi	stroke	oil capacity pull	extended height	price
G2235895	3900 lb	.51"	.24 cu-in	3.55"	<b>\$204.48</b>
G0522207	3900 lb	.98"	.46 cu-in	4.57"	<b>\$209.69</b>
G2084975	6110 lb	.98"	.81 cu-in	4.21"	<b>\$287.50</b>



### ENERPAC

#### Swing Hydraulic Cylinders

- Steel construction
- 90° swing angle
- Turns right
- #4 SAE port
- 500 to 5000 psi

Q#	body	clamping force	stroke	action	price
G0244946	upper flange	1100 lb	.089"	single	<b>\$522.75</b>
G0360771	lower flange	2600 lb	1.12"	double	<b>\$570.16</b>



**ENERPAC Hydraulic Lifting Set**

- 10 ton capacity
- 0.63" to 6" stroke length
- 10,000 psi max

includes mfr. no. P-392 hand pump, HC7206 hose, HF-100 oil, G2535L gauge, GA-3 gauge adaptor, fitting, C604 coupler set, baseplate, WR-5 spreader, RSM-100, RCS-101, RC-106 and RCH-123 cylinders

#	price
G2883395	<b>\$3,782.00</b>

13  
PIECE



**ENERPAC 1 Stage Hydraulic Hand Pump**

- Steel pump
- Fiberglass handle
- 10,000 psi max
- 40 cu-in reservoir capacity
- 5 1/4" w x 23 1/2" l x 4 11/16" h

includes oil



#	price
G2643103	<b>\$323.00</b>

**ENERPAC 2 Stage Hydraulic Hand Pump**

- Aluminum pump
- Fiberglass handle
- 200 psi max 1st stage
- 10,000 psi max 2nd stage

includes oil



#	reservoir capacity	dimensions	price
G2298107	20 cu-in	3 3/4" w x 13 3/4" l x 5 5/16" h	<b>\$344.25</b>
G1550884	55 cu-in	4 3/4" w x 21" l x 7" h	<b>\$406.30</b>

**ENERPAC Electric Hydraulic Pump**

- High force
- 231 cu-in reservoir capacity
- 0.5HP
- 24 VDC control pendant
- 115V
- Universal motor

#	price
G2677464	<b>\$2,083.47</b>



**WESTWARD Air Powered Hydraulic Pump**

- Foot or hand actuation
- 10,000 psi capacity
- 7.8 air consumption SCFM
- 9 1/2 cu-in oil capacity
- 9 1/2" fluid port NPT
- 5" w x 10" l x 7 1/8" h

#	price
G3109854	<b>\$541.58</b>



**OTC Electric Hydraulic Pump**

- High force
- 295 cu-in reservoir capacity
- 1/2 HP
- 115V

includes 6' remote control cord

#	price
G2026927	<b>\$1,161.75</b>



**CONCENTRIC Hydraulic Gear Pump/Motor**

- 4F17 4 bolt mounting
- Cast iron housing
- 0.129 displacement (cu in/rev)
- 0.7 nominal gpm @ 1200 rpm
- Reversible rotation

#	price
G2635726	<b>\$157.58</b>

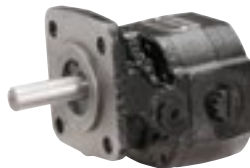

**CONCENTRIC Hydraulic Gear Pumps**

- Aluminum housing
- 4000 continuous psi max
- Cast iron cover
- Pressure-balanced, with 90 percentage overall efficiency and low noise

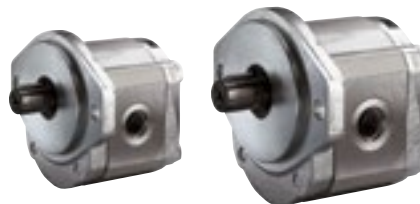

#	displacement	range	flow @ 1200 rpm	continuous pressure	inlet	outlet	price
G0573151	0.49 cu-in/rev	500 to 4000 rpm	2.5 gpm	4000 psi max	1 1/8"-12	7/8"-14	<b>\$199.08</b>
G2759477	0.67 cu-in/rev	500 to 3600 rpm	3.5 gpm	4000 psi max	1 1/8"-12	7/8"-14	<b>\$213.53</b>
G1527407	1.16 cu-in/rev	500 to 3000 rpm	6.0 gpm	4000 psi max	1 1/8"-12	1 1/8"-12	<b>\$224.74</b>
G3092722	1.6 cu-in/rev	500 to 2400 rpm	8.3 gpm	2700 psi max	1 1/8"-12	1 1/8"-12	<b>\$169.75</b>

**ENERPAC Air Powered Hydraulic Pump**

- Foot or hand actuation
- 10,000 psi capacity
- 3/8" fluid port NPT
- 36 cu-in oil capacity
- 9 SCFM
- 5 5/8" w x 14 11/16" l x 5 3/4" h

includes swivel coupling on air intake port

#	price
G2740674	<b>\$632.40</b>



**ENERPAC Air Powered Hydraulic Pump**

- Foot or hand actuation
- 10,000 psi capacity
- 3/8" fluid port NPT
- 127 cu-in oil capacity
- 12 SCFM
- 6 1/2" w x 12 7/16" l x 8 5/16" h

includes exhaust muffler, air and hydraulic inlet filter

#	price
G1402572	<b>\$671.50</b>



# HYDRAULICS

## COOL-LINE D-Series Forced Air Oil Cooler

- Aluminum construction
- 2 to 30 gpm
- 0.08 HP
- SAE#12 port
- 12VDC

includes grill mounting bracket

Z#	price
G3171883	<b>\$309.99</b>



## A-Series Forced Air Oil Cooler

- Aluminum construction
- 2 to 30 gpm
- ¼ HP
- 115/230 VAC
- SAE#12 port

includes mounting feet

Z#	price
G2079743	<b>\$595.74</b>



## D-Series Forced Air Oil Cooler

- Aluminum construction
- 4 to 50 gpm
- 0.19 HP
- SAE#16 port
- 12VDC

includes universal mounting bracket

Z#	price
G2560381	<b>\$407.91</b>



## PARKER Accumulator Charging/Gauge Kit

- 3000 psi max
- 0.960-14" RH accumulator connection SAE
- For use with Greer bladder and piston accumulators

includes 10' hose, adapter, and pressure gauge

Z#	price
G3427794	<b>\$193.72</b>



## CONCENTRIC Birotational Fluid Motor

- 0.323 displacement (cu-in/rev)
- 1.7 nominal gpm @ 1200 rpm
- 3000 continuous psi max
- 7/8-14 ports (inlet)
- Cast iron housing

features lip seal and reversing check valve to avoid a case drain port and allow bi-directional use

Z#	price
G2322451	<b>\$190.55</b>



## COOL-LINE Hydraulic Oil Cooler

- Aluminum material
- Mobile
- 20 HP heat removal
- 2 to 30 gpm
- SAE#12 port size
- 250 psi max

Z#	price
G0755937	<b>\$287.35</b>



## CONCENTRIC Hydraulic Power Unit

- 1 stage
- 1½ gal reservoir capacity
- 1500 psi max
- 1 HP

Z#	dimensions	voltage	price
G1244153	8¾" w x 21¼" l x 8¾" h	230/460 VAC	<b>\$701.29</b>
G0508435	8¾" w x 23" l x 8¾" h	115/280 230 VAC	<b>\$489.14</b>



## CONCENTRIC Hydraulic Power Unit

- 1 stage
- 2.4 gpm nominal flow
- 3000 psi max
- 12VDC
- ½"-18 SAE 6 pressure port
- 5½" w x 12" l x 6½" h
- Built in relief and check valve

Z#	price
G0880887	<b>\$381.92</b>



## WESTWARD Hydraulic Maintenance Set

- For bending, pushing, pulling and spreading
- 10 ton capacity
- 6" stroke length
- 10,000 psi

includes hand pump assembly with hose, heavy duty spreader ram, 2½" rubber head, rubber faced flat base, ram toe and plunger toe, chrome plated, long life ram plunger, serrated saddle, wedge head, combination head and 27, 18, 10 and 4¾" extension tubes

Z#	price
G1063772	<b>\$420.40</b>



14  
PIECE





**PARKER Hydraulic Oil Filter Cart**

- 150°F max operating temp
- 500 SUS max fluid viscosity
- ¾ HP motor
- 109 gpm max
- 40 micron intake filter
- 115VAC

includes (2) 1" dia 7 ft long hoses, (2) 3 ft long wands and (1) filter cart

Z#	price
G0552727	<b>\$1,863.21</b>



**PARKER Replacement Filter Element**

- 10 gpm max
- Single housing
- Nitrile seal
- Inlet filter
- For use with G0552727



Z#	microns	media filter	type	price
G2449447	10	cellulose	discharge	<b>\$35.71</b>
G1828836	40	polyester	inlet	<b>\$29.93</b>

**ENERPAC Hydraulic Oil**

- Specially formulated for hand pumps.
- Reduced handle effort over hf oil
- 1 gal
- 15 ISO viscosity grade
- 105 viscosity index
- 375° flash point

Z#	price
G0930605	<b>\$45.42</b>



**ENERPAC Quick Coupler**

- NPTF connection
- Steel body
- ¾"-18 thread size
- 10,000 psi max
- 10.8 gpm

**Coupler Nipple**  
includes dust cap

Z#	price
G2364747	<b>\$30.60</b>



**Coupler Set**

includes ¾" male and female couplers, dust cap

Z#	price
G3493253	<b>\$66.14</b>



**PARKER**

- NPTF connection
- Hydraulic coupler body
- 4000 psi max
- 6 gpm
- ¾" body size
- Steel body
- Use with ISO 7241-1 series B coupler
- ¾"-18 thread size

includes valve actuator, heavy duty steel nipples and steam

Z#	price
G4662691	<b>\$13.92</b>



**ENERPAC Hydraulic Hand Pump Repair Kit**

- For use with G1550884
- includes filter assembly, screen, inlet adaptor, beam pin and all related o rings, balls, washers, beam pins, gaskets and springs

Z#	price
G1946655	<b>\$81.43</b>



**ENERPAC Hydraulic Coupler**

- NPTF connection
- Steel body
- 10,000 psi max
- 10.8 gpm
- ¾"-18 Thread size

Z#	price
G3153087	<b>\$39.10</b>



**ENERPAC Coupler Set**

- NPTF connection
- Push together locking
- For use with hydraulic systems
- 10,000 psi max
- 10.8 gpm
- ¾"-18 thread size

Z#	price
G3151836	<b>\$153.85</b>



**ENERPAC Hydraulic Hose Assembly**

- High pressure
- Thermoplastic material
- Polyurethane with double wire braid
- 6' length
- ¼" inside hose

Z#	price
G1398074	<b>\$158.95</b>



**PARKER Reservoir Breather**

- 1" NPT inlet
- 5 psi max
- 98.7% efficiency @ 3 micron
- 4" OD
- 5" body length
- Silica gel filter media
- For use with all hydraulic reservoirs

Z#	price
G1860966	<b>\$69.48</b>



**GREENLEE Pole Tamper**

- Open or closed center
- 1160 blows/minute @ 5 gpm
- ¾"-18 SAE O-ring pressure port
- ¾"-16 SAE O-ring return port
- 2000 psi max
- 4" x 60"

Z#	price
G4609351	<b>\$1,513.92</b>





# AUTO & TRUCK, FLUIDS & LUBRICANTS



## TOP BRANDS



### CHARGERS

pg  
235



### JACKS

pg  
236



### ENGINE OILS

pg  
237



### OIL CHANGING

pg  
238



### FILTERS

pg  
239



### GREASES AND GUNS

pg  
240



### PROTECTANTS AND COATINGS

pg  
242



### LUBRICANTS

pg  
244



### HYDRAULIC OILS

pg  
245



### PENETRATING SOLVENTS

pg  
247



**GENERAL ELECTRIC  
Electric Vehicle  
Charging Station**

- 7.2kW output
- 208-240 VAC, 30 A
- SAE J1772 plug
- NEMA 3R enclosure rating
- Pedestal mount
- One connector
- 20' cable
- 14.9" w x 13.8" d x 51.1" h
- ■ UL, cUL, NEC, SAE COMPLIANT



#	price
G5747542*	<b>\$4,463.70</b>

**SCHNEIDER ELECTRIC  
Electric Vehicle  
Charging Station**

- 7.2kW output
- 208-240 VAC, 30 A
- SAE J1772 plug
- NEMA 3R enclosure rating
- Pedestal mount 2
- Two connectors
- 18' cables
- 13.0" w x 6.7" d x 56.2" h
- ■ UL, cUL, NEC, SAE, ROHS COMPLIANT



#	price
G7078023*	<b>\$4,125.11</b>

**SCHNEIDER ELECTRIC  
Electric Vehicle  
Charging Station**

- 7.2kW output
- 208-240 VAC, 30 A
- SAE J1772 plug
- NEMA 3R enclosure rating
- Wall mount 1
- One connector
- 18' cable
- ■ UL, NEC, SAE, ROHS COMPLIANT



#	price
G7077287*	<b>\$1,261.70</b>

**BATTERY TENDER  
Solar  
Battery  
Chargers**

- For battery charging and maintenance
- 12 V rating
- 12' lead

*includes quick disconnect alligator clips*



#	UL rated amps	size	price
G3621247	.3	13 3/4" x 16"	<b>\$51.11</b>
G3678281	.55	16" x 26"	<b>\$73.46</b>
G3602051	.9	16" x 38"	<b>\$102.00</b>

**WESTWARD  
Fleet Battery Charger**

- For heavy duty use in service stations, maintenance shops, farms and fleets
- 40/60 UL rated amps 12V
- 30 UL rated amps 24 V
- 225 UL rated amps start
- 0.3 to 2 hr charge time 12V
- 0.5 to 1 hr charge time 24V
- 6' cable
- ■ UL LISTED



#	price
G1980036	<b>\$549.46</b>

**WESTWARD  
Booster Cables**

- Standard duty
- Commercial
- Built-in positive and negative identification
- 16' length



#	copper	max	price
G1783047	4 (AWG/kcmil)	285 A	<b>\$35.15</b>
G2434293	6 (AWG/kcmil)	200 A	<b>\$26.48</b>

**WESTWARD  
Battery Charger**

- For cars, light and medium duty trucks, tractors
- 10 UL rated amps 12V
- 5 UL rated amps 24V
- 3 to 5 hr charge time
- ■ UL LISTED



#	price
G2395836	<b>\$104.54</b>

**WESTWARD  
Portable  
Power Source**

- Indicates voltage percent
- 250 cranking amps
- 12 V
- 13 1/2" w x 6 1/2" d x 14 1/2" h
- ■ UL LISTED



#	price
G1986686	<b>\$161.64</b>

**BAYCO  
Battery Booster  
Clamps**

- 800A
- 2 pack



#	price
G4105105	<b>\$9.91</b>

**WESTWARD  
4 Way Battery Post  
and Terminal Cleaner**

- Steel
- Cleans dirt and corrosion from battery terminals



#	price
G1897314	<b>\$7.33</b>

**WESTWARD  
Battery Terminal Puller**

- Steel
- Used to remove the battery terminal clamp
- 4" long



#	watts	size	price
G0636851	15	16" x 38"	<b>\$20.83</b>

**QUICK CABLE  
Battery Terminals**

- Lead



#	polarity	stud
G2097724	negative	5/16"
G2602187	positive	3/8"

each **\$4.11**

**VALUE BRAND  
Exterior Throttle Cables**

- Heavy-duty adjustable locking control
- includes weather proof handles and coated cables*



#	length	price
G3895875	180"	<b>\$42.99</b>
G4010851	240"	<b>\$40.09</b>



**FLUKE  
Automotive  
Multimeter Kit**

- 600mV-1000 DC/AC
- 600-50M Ohms
- -200° to 1090° C, -328° to 1994° F
- 199.99-199.99K frequency range (Hz)
- 0.002-1999.9mS pulse width
- 10.00 nF-9,999 F capacitance range
- CAT IV 600 V, CAT III 1000 V safety rating

*includes fluke 88 V automotive digital multimeter, leads (TL224), probes (TP220), alligator clips (AC285), hanger (TPAK) temp. probe (80BK-A), RPM pick-up (RPM80) 2 probe pins, insulation piercing clip, case, (C800), holster, 9 V battery and instructions*

**Z#** price  
G1613823 **\$584.96**



**BAYCO  
Compact  
Fluorescent  
Cord Reel Light**

- 120 VAC, 13 W
- 40' cord
- Angled ergonomic handle
- ■ UL, cUL STANDARDS

*includes mounting bracket*

**Z#** price  
G4169042 **\$47.89**



**CRAFTSMAN  
Jack Stands**

- Steel construction
- 2¼ ton
- 10½" min lift
- 17½" max lift
- 2 pack
- ■ ANSI STANDARDS

**Z#** price  
G3629017 **\$20.92**



**CRAFTSMAN  
High Lift  
Jack Stands**

- Steel construction
- 3 ton
- 13" min lift
- 21" max lift
- 2 pack
- ■ ANSI STANDARDS

**Z#** price  
G3643613 **\$31.92**



**WHITESIDE  
Adjustable  
Creepers**

- Corrosion resistant
- 570 lb capacity
- Steel frame
- 17" w x 44" l x 3½" h
- (6) 2½" casters

**Z#** price  
G3275377 **\$124.65**



**WESTWARD  
Hydraulic Truck Jack**

- 22 ton lifting capacity
- 9½" power raise
- 19¾" max lifting height
- 47¾" handle
- ■ ANSI STANDARDS

*includes jack handle and owners manual*

**Z#** price  
G2554386 **\$762.36**



**PROTO  
Creepers Seat**

- 500lb capacity
- Steel frame
- 16" w x 16" l x 18" h
- (4) 3" casters

*features heavy duty backrest and vinyl-covered foam cushion*

**Z#** price  
G3689366 **\$247.94**



**BAR'S LEAKS  
Hydraulic Jack Oil  
with Stop Leak**

- 12.5 oz
- 480° F boiling point
- 250° F flash point
- 0.872 specific gravity
- 0 VOC content

**Z#** price  
G2119205 **\$3.45**



**CRAFTSMAN  
Hydraulic  
Service Jacks**

- Steel construction
- 5" min lifting height
- 15" max lifting height
- ■ PALD 2009 (ANSI) STANDARDS

*includes jack, handle and owners manual*

Z#	ton	power raise	price
G3735602	2¼	9"	<b>\$52.38</b>
G3619962	3	14"	<b>\$103.84</b>



**PROTO  
Shop Stool**

- Heavy duty steel construction
- Pneumatic adjusting 29" to 34"
- 300 lb capacity
- 14" dia seat

**Z#** price  
G3603521 **\$269.54**



**WHITESIDE  
Creepers Seat**

- Gas filled lift cylinder
- 480lb capacity
- Steel frame
- 18½" w x 16" l x 17" to 22" h
- 3" casters

**Z#** price  
G1672273 **\$122.85**



**WHITESIDE  
Replacement Casters**

- 3" polyurethane
- 4 pack

**Z#** price  
G3081951 **\$26.03**



**TITAN  
Jack Stands**

- Steel construction
- 22 ton capacity
- 13" min lifting height
- 19" max lifting height
- 2 pack

**Z#** price  
G4875622 **\$161.75**



**AUTO DOLLY  
Car Dollies**

- Powder coated steel
- For moving and positioning vehicles

Z#	set	capacity	dimensions	price
G3698554	2	3000 lbs	12" w x 16" l x 4" h	<b>\$68.63</b>
G4230073	4	10,000 lbs	12" w x 16" l x 3½" h	<b>\$280.79</b>



**CRAFTSMAN  
Hydraulic Bottle Jacks**

- Welded, mechanically fastened construction
- With saddle
- ■ PALD 2009 (ANSI) STANDARDS

Z#	ton	lifting height	stroke	screw extension	base	price
G3607335	2	7¼"-13½½"	4½"	2"	3¼" sq	<b>\$16.92</b>
G3633542	6	8½"-16½½"	5¾"	3"	4" x 4½"	<b>\$26.58</b>
G3733441	20	9½"-18½½"	6"	3½"	5½" x 6¾"	<b>\$68.83</b>





**MOBIL Engine Oil**

- For gasoline fueled automobiles and light duty trucks
- -18° to 275° F temperature range
- 1 qt
- ■ API, SM, SL, SJ STANDARDS

Q #	SAE grade	viscosity	specific gravity
G4087474	5W-30	158	0.8607
G4004901	10W-30	140	0.8693
G4020782	10W-40	147	0.8681

each **\$8.11**



**G-OIL Full Synthetic Engine Oil**

- 175 viscosity index
- -49° F pour point
- 437° F flash point
- 32 oz
- ■ API, ILSAC

Q #	SAE grade	price
G4599795	5W-30	<b>\$12.43</b>
G4540785	10W-30	<b>\$12.93</b>



**MOBIL Synthetic Transmission Fluid**

- Manual transmission lubricant provides outstanding high-temperature performance, oxidation stability, wear protection, and corrosion control
- For off-highway industries including: construction, mining, quarrying, and agriculture
- 146 viscosity index
- 1 gal, 50W SAE grade
- ■ API GL-4/MT-1, EATON ROADRANGER E500(TM) PS-164 REV 7, MACK TO-A PLUS, INTERNATIONAL TMS-6816 STANDARDS

Q #	price
G3165267	<b>\$55.21</b>

**VALVOLINE Diesel Oil**

- For modern low-emission diesel engines
- 5W-40 SAE
- 170 viscosity index
- 1 gal



Q #	price
G0897373	<b>\$35.24</b>

**MOBIL Diesel Motor Oil**

- For wide range of heavy duty applications and operating environments found in the trucking, mining, construction, quarrying, marine and agricultural industries
- 15W-40 SAE
- 123 viscosity index
- 1 qt
- ■ ASTM, API CI-4/CH-4/SL/SJ, ACEA E7, A3/B3, A3/B4 STANDARDS



Q #	price
G2039091	<b>\$7.63</b>



**AIR SHIELD Diesel Exhaust Fluid**

- Specially blended to help meet the EPA's near-zero emission requirements in selective catalytic reduction (SCR) diesel engines in 2010 and later models
- Fluid is injected into the engine exhaust to create ammonia, which then flows through an SCT catalyst to create harmless nitrogen and water vapor
- Compatible with all on- and off-highway SCR systems
- ■ ISO 22241 STANDARDS

Q #	size	price
G3536757	1 gal	<b>\$6.11</b>
G3526397	2.5 gal	<b>\$18.89</b>
G4466131	55 gal	<b>\$312.72</b>

**VALVOLINE Motorcycle Oil**

- For motorcycles with 4 cycle engines
- Synthetic blend
- 155 viscosity index
- 32 oz
- ■ API, JASO STANDARDS



Q #	SAE grade
G1200394	10W-40
G1924115	20W-50

each **\$7.55**

**CRC Two Cycle Petroleum Oil**

- Clean burning formula protects against heat, corrosion, and rust
- Use where different ratio mixtures are required
- For engines with 25 HP or less
- 0.883 specific gravity
- 15 oz



Q #	price
G1911332	<b>\$6.19</b>

**ZEREX Antifreeze**

- Original full-chemistry formula for newer Ford/Chrysler vehicles
- Utilizes hybrid organic acid technology to minimize inhibitor depletion
- Low-silicate, low-pH, and phosphate-free
- For Chrysler, Ford, Mercedes, Deere, and GM
- ■ ASTM STANDARDS



Q #	price
G2079122	<b>\$13.22</b>

**PROTO Spill Free Funnel**

- Eliminates trapped air pockets which usually cause erratic cooling system and heater performance
- 6.89" w x 9.84" l x 6.69" h includes threaded cap and adapter for newer GM "threaded style" radiator openings, (4) adapters and angled neck



Q #	price
G3544904	<b>\$40.18</b>

**VALVOLINE Full Synthetic Motor Oil — 32 oz**

- 170 viscosity
- Wear protection for oil film strength plus lower oil vaporization and consumption in extreme conditions
- ■ API, ACEA, ILSAC, FORD, CHRYSLER, GM STANDARDS features increased thermal and oxidation stability and deposit control for reduced formation of sludge



Q #	SAE grade	specific gravity	price
G2387201	5W-30	0.853	<b>\$11.51</b>
G2067965	5W-40	0.85	<b>\$11.83</b>
G3455112	10W-30	0.861	<b>\$11.51</b>



**DAYTON  
Oil Change  
Pump System**

- Complete with 12VDC pump, suction and discharge tubing
- 4.0 gpm
- 3000 SSU max viscosity
- 17 psi max

*includes reversing switch, 8' power leads and 3.5 gallon container*

Z#	price
G1899721	<b>\$231.36</b>



**LIQUIVAC  
Oil Changing Units**

- Hand-pump systems use vacuum action to pull oils and fluids from engines into a durable waste tank
- Extract oil, transmission, differential and hydraulic fluids
- HDPE
- 105° F max operating temperature

*includes (2) hoses, sprout and pitch clamp*



**High capacity**

- For large engines with narrow dipstick tubes, as on boats, cars, and trucks
- 2 gal reservoir capacity
- 5" w x 16" l x 8 1/4" h

Z#	price
G0304491	<b>\$57.39</b>

**Small engine**

- For generators, go-carts, lawn mowers and tillers
- 3/4 gal reservoir capacity
- 8 1/2" w x 17 1/2" l x 10 3/4" h

Z#	price
G1283082	<b>\$35.54</b>



**WYPALL  
Disposable Wipes**

- Hydroknit
- 9 1/2" x 12 1/2"
- 176 sheets/box
- 10 boxes/pack

Z#	price
G1008454	<b>\$63.11</b>



**TOUGH GUY  
Shop Towels**

- New cotton material
- 13" x 13"
- 100 count

Z#	price
G4258861	<b>\$40.76</b>



**PIP  
Nitrile-Coated Gloves**

- Provide high abrasion resistance with a thinner coating while maintaining exceptional comfort, durability and tactile sensitivity
- Super light breathable micro-foam coating keeps hands cool and dry
- Use to handle small oily parts, general assembly, machining, micro-engineering, automotive components, painting, horticulture
- Abrasion level 4

• **ANSI, ISEA, EN388 4141 STANDARDS**

Z#	size	length
G0053846	small	8"
G0053855	medium	8 1/2"
G0053864	large	8 3/4"
G0053873	extra large	9"

pair **\$3.54**



See more  
gloves  
on page  
7

**OIL-DRI  
Spill Kit**

- 19 gal absorption per package
- For oil only

*includes (2) 5" x 10" booms, (20) oil-only pads, (1) 20 gal overpack, (3) disposable bags and ties and (1) emergency response guidebook*

Z#	price
G2814716	<b>\$128.75</b>



**LIQUIDYNAMICS INC.  
Low Profile Oil Drain**

- Steel construction
- 25 gal capacity
- 1" ball drain

*includes (2) internal baffles, steel casters and T-handle*

Z#	price
G7561285	<b>\$775.40</b>



**PROTO  
Oil Drain**

- 8 gal capacity
- 15" dia funnel
- Quick-release lock ring
- Total adjustment range of 22 1/2"

Z#	price
G3547555	<b>\$142.51</b>



**FUNNEL KING  
Drain Pan**

- Chemical resistant polyethylene
- Pour spout and 2 handles
- Anti splash lip
- 4 gal capacity
- 17.3" dia

Z#	price
G3390344	<b>\$14.39</b>



**FUNNEL KING  
Plastic Drain Pan**

- Chemical resistant polypropylene
- For containing spills and drips from machinery, vehicles and drums
- 22" w x 22" l x 1 1/2" h
- **100% TOTAL RECYCLED CONTENT**

Z#	price
G1577213	<b>\$13.18</b>

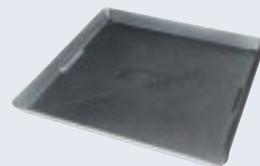

**FUNNEL KING  
Funnel**

- Polyethylene
- 64 oz
- 6 1/2" dia
- 9" length
- Fine mesh straining screen and hanging tab

Z#	price
G2534366	<b>\$2.90</b>



**EAGLE  
Drum Funnel**

- Fits 30 and 55 gal closed head drums
- 18" dia
- HDPE
- Resistant to most chemicals and hazardous wastes
- Provides containment of any spills or splashes
- Allows hands-free draining of filters and small containers

Z#	price
G0964914	<b>\$32.39</b>



**JUSTRITE  
Safety Funnel**

- Steel with red powder coated finish to resist chemicals, corrosion and humidity
- Hinged
- Accommodates padlock
- 10 3/4" dia
- 10" height

Z#	price
G0727133	<b>\$175.82</b>





**BALDWIN FILTERS**

**Spin-On Oil Filters**

- Heavy-duty, all-metal housing provides superior burst- and pulse-withstanding strength
- Steel coil spring maintains positive load pressure on the elements
- Cartridge-style filters assure the seal between the engine block and filter is not disturbed

Z #	MFR#	height	OD	price
G0678377	B34	3 7/8"	3 1/16"	<b>\$4.08</b>
G2805896	B1432	4 1/2"	3"	<b>\$6.08</b>
G2883867	B1441	5 1/2"	3 1/16"	<b>\$6.21</b>
G0365172	B1428	5 1/2"	3 1/16"	<b>\$4.90</b>
G1219014	B7306	5 1/2"	3 1/16"	<b>\$8.24</b>
G0926527	B7349	7"	3 1/16"	<b>\$5.83</b>
G2965986	B7039	7"	4 1/4"	<b>\$11.27</b>



**BALDWIN FILTERS**

**Spin-On Oil/Transmission Filters**

- Heavy-duty, all-metal housing provides superior burst- and pulse-withstanding strength
- Steel coil spring maintains positive load pressure on the elements
- Cartridge-style filters assure the seal between the engine block and filter is not disturbed

• **MORE SIZES AVAILABLE ONLINE**  
includes anti-drain back valve and (1) gasket

Z #	dimensions	by pass valve	price
G2861171	3 1/16" OD x 3 3/8" h	8 psid	<b>\$5.80</b>
G2744095	3" OD x 3 1/2" h	14 psid	<b>\$10.63</b>

**BALDWIN FILTERS**

**Coolant Filter**

- Spin on
  - 5 1/2" h
  - 3 1/16" OD
  - **MORE SIZES AVAILABLE ONLINE**
- includes G381-A 1 gasket

Z #	price
G1094143	<b>\$7.07</b>

**Coolant Filter Base**

- CFB5000
- | Z #      | price          |
|----------|----------------|
| G3193294 | <b>\$30.59</b> |

**BALDWIN FILTERS**

**Cabin Air Filter Elements**

- **MORE SIZES AVAILABLE ONLINE**
- | Z #      | dimensions           | price          |
|----------|----------------------|----------------|
| G1329903 | 9 1/2" OD x 7 1/2" h | <b>\$15.05</b> |
- includes 6 7/8" (174.6) 1 gasket

Z #	dimensions	price
G4548957	7" OD x 4 1/8" h	<b>\$8.29</b>

includes 4 7/8" (123.8) 1 gasket

**BALDWIN FILTERS**

**Outer Air Filters**

- Metal wrapper surface area is 73% open for minimal air flow restriction
- PermaPleat design creates built-in pleat spacing and prevents bunching
- Radial seal filters have seal gaskets made of a special urethane compound that will not degrade due to temperature or changes in restriction or vibration
- **MORE SIZES AVAILABLE ONLINE**



Z #	dimensions	price
G2432805	6 5/8" OD x 12 3/4" h	<b>\$14.92</b>

includes 7 1/8" plastic fins, mfr. no. G103-NF, gasket, (1) attached O gasket, 3/4" (19.1) and 3 1/2" (88.1) 1 gasket

Z #	dimensions	price
G1556694	5 5/8" OD x 11 1/2" h	<b>\$14.71</b>

includes 6 3/8" plastic fins, mfr. no. G103-NF, gasket, (1) attached O gasket, 2 1/2" (16.7) and 2 3/4" (66.7) 1 gasket

**BALDWIN FILTERS**

**Spin-On Fuel Filter/Separator**

- Fuel/water separators feature a unique design with an all-metal, self-venting drain, eliminating the need to separately vent the fuel system prior to draining
- 4 3/2" h
- 3 3/8" OD
- **MORE SIZES AVAILABLE ONLINE**



Z #	price
G1857116	<b>\$11.03</b>

**BALDWIN FILTERS**

**Radial Outer Air Filters**

- **MORE SIZES AVAILABLE ONLINE**

Z #	dimensions	price
G0487873	5 1/2" OD x 12 5/8" h	<b>\$19.52</b>

includes 3 5/8" (81.0) one end 1 gasket

Z #	dimensions	price
G1512865	3 1/2" OD x 7 1/8" h	<b>\$12.32</b>

includes 1 3/4" (44.5) one end 1 gasket

Z #	dimensions	price
G1000824	6 1/2" OD x 14 1/2" h	<b>\$31.16</b>

includes 3 5/8" (90.5) one end 1 gasket

**BALDWIN FILTERS**

**Power Steering Element Filters**

- **MORE SIZES AVAILABLE ONLINE**

Z #	dimensions	price
G0741605	2 5/8" OD x 3 1/2" h	<b>\$6.31</b>

includes G358 F gasket and G232 O gasket

Z #	dimensions	price
G0891046	4 1/2" OD x 8 1/8" h	<b>\$21.04</b>

includes G252 O gasket and (2) end seals attached

Z #	dimensions	price
G1544532	3 1/2" OD x 2 7/8" h	<b>\$5.81</b>

includes G115-A O gasket and (2) end seals attached



**GEARWRENCH**

**Oil Filter Strap Wrench**

- Nylon straps fit filters up to 9" dia
- Universal design for most cars, trucks, tractors, and heavy equipment



Z #	length	price
G1970175	14 1/4"	<b>\$36.66</b>

**Oil Filter Adjustable Pliers**

- Used to remove stubborn filters
- Adjustable 2" to 5"



Z #	length	price
G2703915	11 3/4"	<b>\$41.33</b>

**Oil Filter Swivel Wrench**

- Used to access filters in confined areas
- Swivel handle
- 3 1/2" to 3 7/8" capacity



Z #	length	price
G2851423	7 1/2"	<b>\$9.36</b>

**HASTINGS FILTERS**

**Spin-On Fuel Filter**

- Protect air induction systems, fuel pumps and injectors, and engine oil against damaging contaminants
- 4 5/2" h
- 1 1/2" OD
- **MORE SIZES AVAILABLE ONLINE**



Z #	price
G3106406	<b>\$2.25</b>

**HASTINGS FILTERS**

**Transmission Filter Kit**

- Spin on
  - 5 1/2" w x 11 1/16" l x 4 7/8" h
  - 2 1/16" OD
  - **MORE SIZES AVAILABLE ONLINE**
- includes (1) transmission pan filter and (1) spin-on, (1) grommet, (1) pan gasket and (1) gasket



Z #	price
G2770354	<b>\$26.33</b>

**GOLDENROD**

**Spin-On Fuel Filter**

- 4 1/8" w x 9 1/2" h
  - 4" OD
  - **MORE SIZES AVAILABLE ONLINE**
- includes zinc die-cast top cap, bowl with drain and filter element



Z #	price
G4001855	<b>\$30.92</b>

**Filter Element**

- 3" x 4 1/8"
- Use with G4001855

Z #	price
G3894581	<b>\$5.85</b>



# AUTO & TRUCK

MORE THAN 800,000 ITEMS ONLINE

## LINCOLN Air-Operated Grease Gun

- Fully automatic, continuous operation and variable speed trigger
- 14½ oz cartridge
- 16 oz bulk capacity
- For NLGI grade 2 greases
- 30" hose

*includes filler nipple and bleeder valve, male air nipple and hose attachment clip*



Z#	price
G1752904	<b>\$67.03</b>

## LINCOLN Cordless Grease Gun

- 12VDC
- Cartridge, suction or bulk fill
- 6000 psi max operating pressure
- 30" hose

*includes Ni-cad battery*

Z#	price
G1901155	<b>\$206.36</b>



## MOBIL Bearing Grease

- For pulling power, control, instrumentation and communication cables
- Wax based emulsion
- 12.5 oz cartridge
- 10° to 194° F



Z#	price
G3452364	<b>\$9.05</b>

## MOBIL Multipurpose Auto Grease

- For chassis, universal joints, disc brake wheel bearings in automotive, fleet, farm and off highway service
- 14 oz cartridge



Z#	price
G1284552	<b>\$3.94</b>

## ULTRALUBE Disc/Drum Wheel Bearing Grease

- For AG equipment, wheel bearings and trailer bearings
- Lithium complex
- 16 oz
- 40° to 427° F
- NLGI grade 2



Z#	price
G3626366	<b>\$5.89</b>

## MOBIL Grease

- Multipurpose, extreme pressure grease recommended for automotive and industrial applications
- Lithium complex
- 12 oz cartridge
- 40° to 300° F
- NLGI grade 2



Z#	price
G0938077	<b>\$19.83</b>

## MOBIL Delvac Extreme Grease

- Contains a high viscosity base oil, a lithium complex thickener and water spray off resistance
- 14 oz cartridge
- 20° to 175° F
- NLGI grade 2



Z#	price
G3299107	<b>\$15.02</b>

## MOBIL Multipurpose Grease

- For higher speed applications such as electric motors, where reduced friction, low wear, long service life are required
- Lithium complex
- 12.5 oz cartridge
- 40° to 350° F
- 100 viscosity @ 40° C
- NLGI grade 2



Z#	price
G1866505	<b>\$8.81</b>

## JET-LUBE Automotive and Industrial Grease

- For automotive and industrial equipment
- 1.0 specific gravity
- 14 oz cartridge
- SAE-AMS-G-4343, MIL-G-4343 FOR PNEUMATIC SYSTEMS STANDARDS



Z#	price
G2365176	<b>\$23.98</b>

## PLEWS-LUBRIMATIC Lubricating Grease

- Lithium/12-hydroxy stearate
- 3 oz cartridges
- 20° to 280° F
- NLGI grade 2
- 0.90 specific gravity
- 4 pack



Z#	price
G2271157	<b>\$10.92</b>

## PLEWS-LUBRIMATIC Lubricating Grease

- Lithium/12-hydroxy stearate
- 3 oz cartridges
- 0° to 280° F
- NLGI grade 1.5
- 0.90 specific gravity
- 4 pack



Z#	price
G1165787	<b>\$8.49</b>

## MOBIL Multipurpose Grease

- For industrial, automotive, and construction
- Lithium complex
- 0° to 347° F
- 5 gal pail
- NLGI grade 2



Z#	price
G2393614	<b>\$160.82</b>

## FLUID FILM Lubricant/Corrosion Inhibitor

- Nondrying, anticorrosive coating protects metal from moisture, salt air, and saltwater
- Creates a moisture barrier that provides long-lasting lubrication for moving parts
- 1 gal
- Less than 1% VOC content



Z#	price
G3706507	<b>\$37.67</b>

## FLUID FILM Lubricant/Corrosion Inhibitor

- Nondrying, anticorrosive coating protects metal from moisture, salt air and saltwater
- Creates a moisture barrier that provides long-lasting lubrication for moving parts
- 5 gallon pail
- 0.1% VOC content
- .903 - .913 specific gravity



Z#	price
G3620434	<b>\$148.43</b>



**WESTWARD  
Parts Washers**

- For use with non-flammable, water-based degreaser or cleaning agents
- Powder coated 20 gauge steel
- 0.035 HP, 264 gph @ 1/2 ft pump
- 120 V/60 Hz
- ■ UL PUMP STANDARDS



**Bench Top**

*includes components shelf*

#	tank capacity	load capacity	dimensions	price
G2054202	3 1/2 gal	29.1 lb	11 3/4" w x 15 3/4" l x 8 3/4" h	<b>\$103.04</b>

**Free Standing**

*includes large components shelf and small parts tray*

#	tank capacity	load capacity	dimensions	price
G0683636	20 gal	100 lb	19" w x 28 3/4" l x 34 1/2" h	<b>\$256.89</b>

**OIL EATER  
Cleaner  
Degreaser**

- Water based
- Removes grease, oil, dirt and grime
- Readily biodegradable per OECD or ASTM standards; and VOC level per SCAQMD requirements
- ■ CALIFORNIA SOUTH COAST AIR QUALITY CONTROL AND USDA APPROVED STANDARDS



#	size	price
G2636347	1 gal	<b>\$8.18</b>
G3142501	5 gal	<b>\$50.39</b>

**GRAYMILLS  
Parts Washer  
Cleaning Solvent**

- Super agitene
- Removes grease and oil
- Dark green
- 141° F flash point
- 5 gal



#	price
G0663765	<b>\$101.52</b>

**ZEP PROFESSIONAL  
Parts Washer  
Cleaning Solvent**

- Petroleum/D-limonene
- Removes grease and oil
- Clear
- 142° F flash point
- 5 gal



#	price
G2118706	<b>\$93.06</b>

**GUNK Low VOC Brake Parts Cleaner**

- For conventional brake units, linings and shoes, drums, cylinders, springs, disc brake units, CV joints, caliper units, brake pads, discs and related parts
- 22oz can, 14oz net wt
- Clear
- 0% VOC content
- ■ SARA 311, 312, AND 313 REPORTABLE, COMPLIANT WITH SCAQMD CALIFORNIA RULE 1171



#	price
G1439724	<b>\$3.15</b>

**CRC  
Non-Chlorinated Brake Parts Cleaner**

- For ABS, disc, drum, brake cylinders, brake drums, brake linings, brake shoes, calipers, clutch discs, disc brake pads and discs
- 20 oz can, 14 oz net wt
- Clear
- Under 0° F flash point
- ■ ROHS COMPLIANT



#	price
G3072106	<b>\$3.19</b>

**CRC  
Chlorinated Brake Parts Cleaner**

- For ABS, disc, drum, brake cylinders, brake drums, brake linings, brake shoes, calipers, clutch discs, disc brake pads and discs
- 20 oz can, 19 oz net wt
- Clear
- ■ ROHS COMPLIANT



#	price
G2813124	<b>\$3.75</b>

**CRC  
Non-Chlorinated Low VOC  
Brake Parts Cleaner**

- For brake linings, brake parts, clutches, wheel cylinders, springs, CV joints, disc brake parts
- 20 oz can, 14 oz net wt
- Clear
- 70.2g/L VOC content
- ■ ROHS COMPLIANT



#	price
G2882914	<b>\$3.46</b>

**CRC  
Chlorinated Electronic Parts Cleaner**

- For air tools, alternators, battery chargers, bearings, cables, chains, clutches, compressors, dies, electric motors, generators, grinders, motor windings, motors, pumps, solenoids, starters, steel, tools, and wire rope
- 20 oz can, 19 oz net wt
- 1.62 specific gravity
- 0% VOC content
- ■ ROHS COMPLIANT



#	price
G1352145	<b>\$5.04</b>

**CRC  
Carburetor and Choke Cleaner**

- For automatic chokes, carburetor components, heat risers, intake parts, and positive crankcase ventilating systems
- Will not harm oxygen sensors
- 16 oz can, 12 oz net wt
- 70.2g/L VOC content
- ■ ROHS COMPLIANT



#	price
G1880873	<b>\$7.46</b>

**CRC  
Battery Terminal Cleaner**

- Use to restore battery output and reduce voltage leakage due to contaminants
- 12oz can, 11oz net wt
- Clear liquid
- 82.16g/L VOC content
- ■ ROHS COMPLIANT



#	price
G2380716	<b>\$4.31</b>

**CRC  
Low VOC Fuel Injection  
and Intake Cleaner**

- For fuel injected gasoline engines (both throttle body and multi-port)
- 16 oz can, 12 oz net wt
- Flash point less than 0° F
- 71.4g/L VOC content
- ■ ROHS COMPLIANT



#	price
G2244952	<b>\$3.00</b>

**OTC  
Canister Fuel  
Injector Cleaner**

- Cleans injectors more effectively with a solvent than aerosol methods
- For use with Ford, Chrysler, and GM

*includes gauge, hose, air regulator, O-ring and coupler socket*

#	price
G3017777	<b>\$129.76</b>



**GUNK Engine Degreaser**

- Removes grease and grime from auto, power mower, marine and tractor engines, metals, concrete and tires, industrial equipment where water is permitted
- 15oz net wt
- 165° F flash point
- 0.86 specific gravity



#	price
G3644392	<b>\$3.76</b>



# AUTO & TRUCK

MORE THAN 800,000 ITEMS ONLINE

### 303 Vehicle Interior Protectants

- 303 Aerospace
- 7.0-7.9 pH



Z#	capacity	price
G3005423	16 oz	<b>\$8.75</b>
G1064472	1 gal	<b>\$40.46</b>

### ZEP PROFESSIONAL Trailer Wash and Aluminum Brightener

- Removes dirt and road film
- Non-acid
- Use with automatic truck wash or pressure washer
- 5 gal



Z#	price
G4883426	<b>\$72.00</b>



### SLIP-N-GRIP Paper Floor Mats

- 60 lb plain paper
- 17" x 22"
- White
- 500 pack

Z#	price
G1932603	<b>\$35.99</b>

### RUST-OLEUM Engine Enamels

- Finish resists oil, gas, grease, rust, salt, humidity, and solvents
- Spray at any angle
- [▶ MORE COLORS AVAILABLE ONLINE](#)

Z#	color	spray can	sq ft	dry time	max temp
G3460003	clear	16oz	10 to 15	20 min	500° F
G0639502	flat black	12oz	6 to 10	30 min	2000° F
G1987501	chevy orange	12oz	10 to 15	20 min	500° F
G2819117	flat aluminum	12oz	6 to 10	30 min	2000° F
G2548987	flat red	12oz	6 to 10	30 min	2000° F

each **\$4.69**



### RUST-OLEUM Truck Bed Coating Aerosol

- "Any-angle spray" technology provides easy application in hard-to-reach areas
- 15 oz covers 15 to 20 sq-ft
- 60 min dry time
- Apply at 50° to 90° F

Z#	color
G3042137	black
G3540241	tan

each **\$6.51**



### RUST-OLEUM Rubberized Undercoating

- Protects metal surfaces from corrosion and moisture
- 15 oz covers 5 to 10 sq-ft
- 1 to 2 hr dry time
- 50° to 90° F application temperature

Z#	price
G0903865	<b>\$3.18</b>



### RUST-OLEUM Rust Reformer

- Spray on to convert rusty surfaces into a non-rusting, paintable flat-black surface, and to prevent future rusting, without sanding down to bare metal
- 10.25 oz
- 24 hr dry time
- 50° to 90° F application temperature

Z#	price
G3539934	<b>\$5.87</b>



### RUST-OLEUM Truck Bed Coating

- Provides a durable nonskid finish that also resists impact, scratches, weather damage, fading, salt, and solvents
- Textured finish
- 4 hr dry time
- 619 g/L VOC content
- Roller or spray application

Z#	capacity	coverage	price
G1610131	1 quart	35 to 40 sq ft	<b>\$19.35</b>
G0418196	1 gallon	140 to 160 sq ft	<b>\$61.87</b>

### DYNA Wiper Arms

- Wet pantograph
- Metal
- For school bus or RV
- 1 pack

Z#	size	price
G2573961	24"	<b>\$47.73</b>
G1450653	26"	<b>\$52.95</b>
G3489841	28"	<b>\$62.00</b>
G2438992	31.5"	<b>\$63.15</b>



### WEXCO Heavy Duty Wiper Blades

- Metal
- 1 pack

Z#	size	saddle	application	price
G3449266	32"	13.6 mm	RV	<b>\$17.58</b>
G2836547	40"	21 mm and 27 mm	transit buses	<b>\$40.67</b>



### 303 Windshield Washer Tablets

- Clean road film, grime, and bugs from windshield
- For autos/light/heavy duty trucks
- 1 tablet mixed w/1 gal water makes 1 gal solution
- 32° F freezing point
- 25 pack

Z#	price
G1716784	<b>\$10.92</b>

### Splash Guards

- Classic black
- Universal fit for HD trucks and trailers
- 0.25" nyracord rubber

Z#	width	length	price
G1481024	24"	30"	<b>\$13.66</b>
G1783686	24"	36"	<b>\$14.59</b>

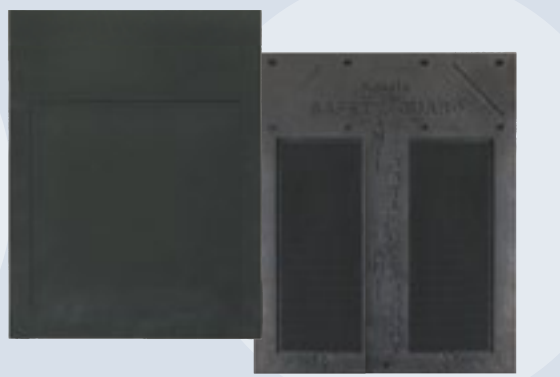

**REFLEXITE**

**Truck & Trailer Reflective Tape**

- 5 yr reflective tape
- 8mil polyester
- 2" x 150'
- 11" red/7" white
- ■ FMVSS 108, DOT-C2, NHTSA STANDARDS



#	price
G1010177	<b>\$71.26</b>

**Emergency Vehicle Reflective Tape**

- 1" x 150'
- White
- ■ DOT/FMVSS STANDARDS



#	price
G1688644	<b>\$62.00</b>

**School Bus Reflective Tape**

- 1" x 150'
- School bus yellow
- ■ FMVSS 131, FMVSS 217 STANDARDS



#	price
G3518803	<b>\$84.13</b>

**CAMEL**

**Tire Repair Boots**

- For automotive and light-duty truck tires
- Plug-n-patch
- Rubber
- 1.88" dia

#	pack	price
G1797187	15	<b>\$21.22</b>
G1808292	20	<b>\$24.87</b>
G2516893	48	<b>\$46.60</b>



**BUYERS PRODUCTS Hitch Pins**

- Powder coated
- High visibility
- Universal

includes zinc-plated cotter pin

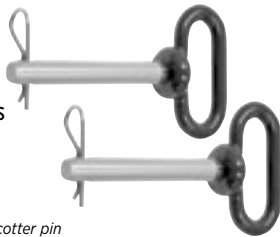

#	size	price
G3661393	1/2" x 4"	<b>\$3.35</b>
G3681736	3/8" x 4"	<b>\$4.37</b>

**GROTE**

**Bolt-On Receiver Tube**

- 2" receiver tube welded to a 1/2" thick, 5" wide x 6" high steel mounting plate
- Black powder coat finish
- 5/8" hitch pin hole

#	price
G4193655	<b>\$47.94</b>



**GROTE**

**Triple Ball Mount**

- 1 7/8", 2" and 2 5/16" ball
- Capacity GVW balls, 6,000, 7,500 and 10,000
- Shank for 2" receivers
- 5/8" hitch pin hole

#	price
G1387592	<b>\$104.31</b>

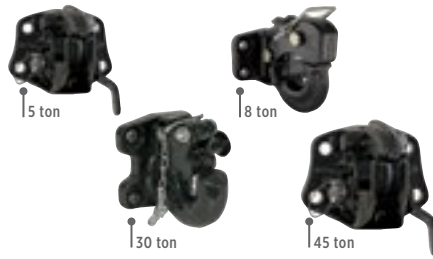

**BUYERS PRODUCTS Pintle Hooks**

- Finished with black powder coat for superior durability and corrosion resistance
- Universal

includes mounting kit, mounting info., spec. sheet, drilling template and vehicle capacity decal

#	ton	capacity	price
G3605515	5	10,000 mgtw; 2,000 mvl gvw (lb)	<b>\$42.34</b>
G3699561	8	16,000 mgtw gvw (lb)	<b>\$44.00</b>
G3639072	30	60,000 mgtw; 15,000 mvl gvw (lb)	<b>\$125.73</b>
G3694074	45	90,000 mgtw; 18,000 mvl gvw (lb)	<b>\$198.72</b>

**CAMEL**

**Universal Cement**

- Adheres patches to the inner surface of tires
- Nonflammable, for every type of tire
- 32° F operating temp
- 100° F max storage temp
- 8 oz



#	price
G1889736	<b>\$6.62</b>

**CAMEL**

**Radial Tire Repair Boots**

- For automotive and light-duty truck tires
- Professional-grade patches for permanent repairs
- Rubber



#	pack	price
G2559803	10	<b>\$11.20</b>
G0252034	20	<b>\$11.23</b>
G1518763	30	<b>\$13.99</b>



**48**  
PIECE

**SLIME**

**Safety Spair Flat Tire Repair System**

- For automotive and light-duty truck tires
- 24 oz
- 150 psi range

includes compressor with built-in gauge and light, tire sealant, 24 oz slime tire sealant with fibro-seal technology, 12V heavy duty tire inflator with light and gauge, 16' coiled air hose and an adapter, rugged storage case, 10 piece tire tackle kit containing valve cores, key valve core removal tool and valve caps, (30) black plugs, t-handle reamer and plunger, tire gauge, alligator clips, slime decal set and instructions in both English and Spanish

#	dia	size	price
G0768634	10.8"	14" x 4.4"	<b>\$100.96</b>



**VALUE BRAND**

**Weld-On Grab Hooks**

- Forged steel
- Grade 43

#	capacity	size	price
G1244853	gvw 5400 lb	3/8"	<b>\$3.84</b>
G1342153	gvw 3900 lb	5/16"	<b>\$2.63</b>

**GROTE**

**Utility Trailer Lights**

- 12V incandescent bulb
- Hardwired terminal
- 4 1/2" w x 3" d x 5" l
- 2" base mounting centers



#	type	price
G3368181	right hand	<b>\$8.24</b>
G2945241	left hand	

**GROTE**

**Stop/Tail/Turn LED Bulb**

- 10-diode pattern
- 4 5/16" dia
- 12V
- 0.03 to 0.24 A
- Male pin terminal



#	price
G1671117	<b>\$15.83</b>

**GROTE**

**Square Corner Lamps**

- 13 diode led lamp
- 2" x 4"
- 12V
- 0.15 A
- Hardwired



#	color	price
G1971514	yellow	<b>\$7.02</b>
G0393057	red	

**GE LIGHTING**

**Halogen Sealed Beam Lamps**

- Auto headlamp high/low beam
- Type 2B1
- 3 contact lugs
- 200mm
- 12.8V
- Meets 2012 lighting legislation energy
- ► MORE AVAILABLE ONLINE



#	watts	price
G2923286	65/35	<b>\$8.47</b>
G2634913	65/55	<b>\$10.25</b>



# FLUIDS & LUBRICANTS

MORE THAN 800,000 ITEMS ONLINE

## WD-40 Lubricants

### Standard

Z#	size	type	price
G1670934	3 oz	aerosol	<b>\$2.62</b>
G3419726	8 oz	smart straw	<b>\$3.92</b>
G0799014	11 oz	smart straw	<b>\$5.09</b>
G3400442	12 oz	smart straw	<b>\$5.97</b>
G3406557	16 oz	industrial size	<b>\$5.18</b>
G2056625	18 oz	big blast	<b>\$5.79</b>
G0815227	1 gal	pour spout	<b>\$19.87</b>
G3177474	5 gal	pour spout	<b>\$97.01</b>



### California Only Lubricants 25% VOC

Z#	size	type	price
G5417587	3 oz	aerosol	<b>\$2.62</b>
G5417614	8 oz	smart straw	<b>\$3.92</b>
G5417623	11 oz	smart straw	<b>\$5.09</b>
G5417596	12 oz	smart straw	<b>\$5.97</b>
G5417641	16 oz	industrial size	<b>\$5.18</b>
G5417666	18 oz	big blast	<b>\$5.79</b>
G5417605	1 gal	pour spout	<b>\$19.87</b>



### CRC Chain Lube

- 16 oz aerosol can, 12 oz net
- Greater than 500°F flash point
- 8°F to 325°F
- Mineral oil base
- ■ NSF REGISTERED, H1 STANDARDS, ROHS COMPLIANT



Z#	price
G2736955	<b>\$12.26</b>

### CRC Dry Moly Lube

- 16 oz aerosol can, 11 oz net
- Dry film lubricant with high antifriction and antiseizure properties is fast drying and nonconductive
- Molybdenum disulfide base
- Up to 650°F



Z#	price
G1197034	<b>\$10.51</b>

### CRC Food-Grade Silicone

- 16 oz aerosol can, 10 oz net
- Produces a clear film that lubricates and protects food processing and handling equipment
- -40°F to 400°F
- ■ NSF REGISTERED, H1 STANDARDS



Z#	price
G2568587	<b>\$6.23</b>

### LPS Greaseless Lubricant

- 11oz net aerosol can
- Displaces moisture, is safe on most seals, paint, plastics
- 175°F flash point
- Green environmental attributes
- ■ NSF REGISTERED, H2



Z#	price
G3091225	<b>\$9.47</b>

### LIQUID WRENCH Aerosol Silicone Spray

- 11oz net aerosol can
- 125°F flash point
- Xylene, CO2 base
- Waterproofs and protects with a thin, clean, non drying film to reduce friction and galling



Z#	price
G3716851	<b>\$2.75</b>

### TRI-FLOW PTFE Industrial Lubricant

- 16 oz aerosol can
- -60°F to 475°F
- Protects against rust and corrosion
- Penetrates and lubricates while removing dirt and contaminants
- Used on cables, ball socket joints, air power tools, conveyors, electric power tools



Z#	price
G1846397	<b>\$8.23</b>

### SPRAYON Food Grade Mold Release

- 16 oz aerosol can, 12 oz net
- 40°F to 550°F
- Low viscosity silicone ideal for hot or cold molds
- Use for plastic injection molders, candle holders, investment castings, extruders, blow molders, foundries



Z#	price
G0937614	<b>\$6.94</b>

### SLIP PLATE Graphite Dry Film Lubricant

- 12 oz net aerosol can
- -75°F to 400°F
- Reduces friction in sliding, twisting or spinning parts
- Bonds quickly to clean metal and wood



Z#	price
G2655791	<b>\$7.86</b>

### JET-LUBE Anti Seize Compound

- 12 oz net aerosol can
- -65° to 1800°F
- Semi-solid paste film
- Ideal for threaded connections
- ■ MIL-PRF-907F STANDARDS



Z#	price
G7473794	<b>\$20.74</b>

**TAP MAGIC EP-Xtra Cutting Oil**

- Breaks down surface tension and prevents metal-to-metal adhesion
- 300°F flash point
- 120 viscosity
- For use on all metals
- ■ OSHA STANDARDS



Z #	size	price
G1683893	4 oz	\$2.23
G2336031	16 oz	\$8.91

**MOBIL MobilMet(R) 766 Extra High Performance Cutting Oil**

- 5 gal bucket
- 205°F flash point
- 6.1 cSt @ 100°C
- Transparent, chlorine-free antimist fluid controls buildup on tool tip



Z #	price
G1520294	\$124.95

**MOBIL Mobilgear SHC 630 Synthetic Gear Oil**

- 1 qt bottle
- 235°C flash point
- SAE grade 90
- 220 ISO viscosity grade
- For industrial enclosed gears, speed and gear reducers, plain and roller bearings



Z #	price
G0943074	\$15.69

**MOBIL Vactra No. 2 Way Oil**

- 5 gal pail
- 228°C flash point, -18°C pour point
- SAE grade 30, 68cSt @ 40C
- For lubrication of machine tool slideway systems
- Approved by major machine tool builders such as Cincinnati Milacron, Okuma, Bijur



Z #	price
G0584735	\$94.80

**MOBIL Vacuum Pump Oil**

- 1 qt bottle
- 450°F flash point
- 15°F pour point
- SAE grade 20
- ISO viscosity grade 68
- Recommended where high vacuum is required



Z #	price
G1612956	\$7.97

**LENOX Semi-Synthetic Cutting Oil**

- 5 gal carboy
- 8.8 to 9.5 pH value
- Provides cooling and lubrication when machining a wide variety of metals
- Does not contain sulphur, chlorine or silicone and is non carcinogenic
- ■ READILY BIODEGRADABLE PER OECD OR ASTM STANDARDS



Z #	price
G1436793	\$109.80

**MOBIL Mobilcut 102 Water Soluble Cutting Oil**

- 1 gal can
- 354°F flash point
- 35 cSt @ 40°C
- -6°C pour point
- Emulsifies easily, contains bactericide to guard against odors



Z #	price
G3015914	\$28.30

**MARVEL MYSTERY OIL Oil Additives**

- 128°F flash point
- -65°F pour point
- For use with automobile, motorcycle, marine, two-cycle, tractor, gasoline and pre-2007 diesel motors



Z #	bottle size	price
G0455201	32 oz	\$4.34
G0490375	1 gal	\$16.79

**MOBIL Mobilgear 600 XP 150 Oil**

- 1 gal bottle
- Mineral oil base
- 230°C flash point, -24°C pour point
- 150 ISO viscosity grade, 90 viscosity index
- For use with industrial spur, helical and bevel enclosed gears



Z #	price
G0275046	\$22.04

**MOBIL Air Compressor Oil**

- 1 gal
- SAE 30
- ISO viscosity grade 100
- ■ ASTM STANDARDS



Z #	price
G2706541	\$19.39

**RIDGID Pipe Thread Cutting Oils**

- 1 gal can
- Used on PCBs and heavy metals
- 385°F flash point
- Free of chlorine and other halogens
- Low odor and anti-mist

**Premium Dark**

- Traditional mineral oil

Z #	price
G0357165	\$19.15

**Premium Nu-Clear**

- Clear mineral oil that maintains workable viscosity to -20°F

Z #	price
G3130312	\$23.76



**MOBIL Premium Hydraulic Oils**

- Antiwear industrial oils meet the requirements of all conventional and high-output hydraulic systems
- For hand- and power-operated jacks, scissor jacks, and hand pumps
- Operate in a wide range of temperatures while handling heavy loads

Z #	type	SAE grade	ISO viscosity	size	price
G3321692	DTE 24	10	32	1 gal	\$28.65
G2725974	DTE 24	10	32	5 gal	\$75.15
G2266187	DTE 26	20	68	1 gal	\$24.24
G0838896	DTE 25	15	46	5 gal	\$75.99





# FLUIDS & LUBRICANTS

MORE THAN 800,000 ITEMS ONLINE



### LINCOLN Pistol Grip Grease Gun

- For use with 14½ oz cartridges or 16 oz bulk
- 34 strokes for 1 oz output
- 6000 psi (max)
- 15½" length

features a cast pump head, 18" hose and follower

Z#	price
G2969775	<b>\$16.97</b>

### LINCOLN Lever Handle Grease Gun

- For use with 16 oz bulk or 14½ oz cartridge
- 33 strokes for 1 oz output
- 10,000 psi (max)
- 21¼" length

includes (1) 18" whip hose and end coupler

Z#	price
G0513493	<b>\$21.52</b>



### LINCOLN Air Operated Grease Gun

- 3-way fill air for 16 oz bulk or 14½ oz cartridge
- Fully automatic with a variable speed trigger and excellent grease flow
- 6,000 psi (max), 40 to 150 psi air operating range
- 17" length

includes filler nipple and bleeder valve, male air nipple, and hose attachment clip

Z#	price
G1752904	<b>\$67.03</b>



### JET-LUBE Silicone Compound DM Grease

- 5.3 oz tube
- Translucent
- Used to protect ignition systems, spark plug connections, electrical assemblies, cable, battery terminals from moisture
- ■ NSF REGISTERED, H1 STANDARDS

Z#	price
G1778217	<b>\$10.49</b>



### MOBIL Mobilegrease XHP 222 Multipurpose Grease

- 14.1 oz cartridge, dark blue
- 0 to 347°F, 400°F flash point, 536°F drop point
- NLGI grade 2
- Lithium complex base
- Use in automotive, construction, and marine applications, and on chassis components and farm equipment

Z#	price
G0532226	<b>\$4.48</b>



### MOBIL Mobilux EP Industrial Grade Grease

- 14 oz cartridge
- Brown
- -20° to 120° F
- Lithium hydroxystearate base

#### Mobilux EP 1

- Recommended for centralized lubrication systems and other applications where low temperature performance is required

Z#	NLGI grade	price
G2182966	1	<b>\$3.19</b>



#### Mobilux EP 2

- Recommended for antifriction, plain bearings, bushings, pins under normal operating condition

Z#	NLGI grade	price
G0667807	2	<b>\$3.89</b>



### LEGACY Portable Grease Pump

- 3" air motor size, 12' hose, fits 5 gal pail
- 22 oz volume per minute
- 5,000 psi
- Use with NLGI #2 grease
- includes pump, air coupler, booster gun with 360°, Z swivel, rubber edged follower plate, hose, and heavy duty metal dolly

Z#	price
G1040094	<b>\$596.75</b>



### ULTRALUBE White Lithium Grease

- 5 gal pail
- Lithium base, off white
- -40° to 387°F
- Up to 620°F flash point, 387°F dropping point
- NLGI grade 2
- Used for general lubrication, auto, truck chassis, machinery, ag equipment
- ■ NLGI 2LB STANDARDS

Z#	price
G3669337	<b>\$184.13</b>



### MOBIL Grease

- 14.1 oz cartridge
- 0 to 500° F
- NLGI grade 2, aluminum complex base
- Designed for lubrication of food processing machinery
- ■ NSF REGISTERED, H1 STANDARDS

Z#	price
G3258927	<b>\$22.34</b>



### JET-LUBE Food Grade Silicone DM Grease

- 14 oz cartridge
- -70° F to 400° F
- 500° F flash point
- NLGI grade 3
- Protect ignition systems, spark plug connections, electrical assemblies, cable, battery terminals from moisture

Z#	price
G0503876	<b>\$23.25</b>



### LINCOLN Air Operated Grease Pump

- 2.5" air motor size, 7' hose, fits 25 to 50 lb container
- 80 cu-in per minute
- 7,500 psi
- Use with NLGI #1 & 2 grease
- includes drum cover, follower plate, air coupler/nipple, grease hose, straight swivel, universal swivel, and control valve

Z#	price
G1664616	<b>\$723.10</b>



**CRC SP-400 Corrosion Inhibitor**

- 5 gal, dark amber liquid
- 119° F flash point
- Firm, waxy film, corrosion resistant, displaces moisture, resistant to humidity and salt spray
- Protects outdoors up to 2 years
- For use with motors, shafts, and equipment exposed to elements



#	price
G1497246	<b>\$236.54</b>

**LPS Premier Rust Inhibitors**

- 16 oz aerosol can, 11 oz net
- Waxy film stops rust and corrosion and provides protective coating for up to 2 years
- Penetrates to displace moisture and provides anti-seize coating



#	price
G0736461	<b>\$13.82</b>

**CRC Penetrating Solvent**

- 16 oz aerosol can, 13 oz net
- Petroleum base
- 126° F flash point
- Used on nuts, bolts, pins, screws, bushings, clips, hinges, snaps, lugs, caps, locks, washers, sliding mechanisms
- 43.3% VOC
- NSF H2 STANDARDS, ROHS COMPLIANT



#	price
G2382651	<b>\$9.47</b>

**WESTWARD Digital Oil Control Gun**

- For motor oil, gear oil, transmission fluids
- 5 pint/qt/L/gal
- 36.8 quarts/minute
- ½ FNPT swivel input
- 12" angled flexible extension



#	price
G2806711	<b>\$222.96</b>

**OIL EATER Cleaner Degreaser**

- 1 gal bottle
- Water-based
- Removes grease, oil, dirt and grime
- Nontoxic, nonflammable, and nonhazardous
- USDA STANDARDS, BIODEGRADABLE



#	price
G2636347	<b>\$8.18</b>

**CORROSIONX Corrosion Inhibitor Penetrant Lubricant**

- 16 oz net aerosol can
- Amber color, non toxic, prevents or kills rust, non ozone depleting
- Greater than 212 of flash point
- For ferrous/non-ferrous metals



#	price
G0678675	<b>\$11.24</b>

**WD-40 SPECIALIST Liquid Rust Remover**

- 1 gal plastic bottle
- Water based
- Used for auto restoration, antiques, tractors, farm equipment, rusty tools, equipment
- READILY BIODEGRADABLE ROHS COMPLIANT PER OECD OR ASTM STANDARDS



#	price
G4477234	<b>\$24.14</b>

**DYKEM Steel Blue Layout Fluid**

- Dries quickly
- Thin film applied to workpiece remains flexible without cracking or chipping
- Works on a variety of materials including metals, aluminum and glass
- Noncorrosive and toluene-free
- For tool and die makers, maintenance mechanics, machinists and pattern makers



#	size	price
G2680815	4 oz brush-in-cap	<b>\$5.85</b>
G2442361	12 oz net aerosol can	<b>\$10.89</b>

**TRIM E206 Emulsion Coolant**

- 5 gal bucket
- 8.8 to 9.2 (operating) pH value
- Contains extreme-pressure additives to control built-up edge
- Used on ferrous and non-ferrous material, machining center work such as high speed turning and grinding
- Leaves soft protective film, coolant residue removes with water



#	price
G1505971	<b>\$154.78</b>

**FLUID FILM Corrosion Inhibitors**

- Solvent- and toxin-free aerosol coating protects metal from corrosion caused by moisture, salt air, and saltwater
- 0.1% VOC

#	size	color	price
G3706507	1 gal can	clear straw liquid	<b>\$37.67</b>
G3620434	5 gal metal pail	amber	<b>\$148.43</b>



**BLASTER Heavy-Duty Solvents**

- Petroleum base
- 155° F flash point
- For use in mechanical repairs

#	size	price
G1858001	11 oz aerosol can	<b>\$3.93</b>
G3120625	1 gal can	<b>\$25.05</b>



**LOCTITE Nickel Anti Seize Pastes**

- Greater than 200° F flash point
- -65° F to 2400° F
- Protect metal parts from rust, corrosion, galling and seizing on high temperature applications
- 2.47% VOC

#	size	price
G3419254	8 oz	<b>\$17.92</b>
G0452977	16 oz	<b>\$28.99</b>



**LOCTITE Anti Seize Compound**

- 1 lb brush top can
- Copper based
- 200° F flash point
- -30° F to 1800° F
- Protects metal parts from rust, corrosion, galling and seizing on high temperature applications

#	price
G3186784	<b>\$19.43</b>





# ABRASIVES & POLISHERS, WELDING & SOLDERING



## TOP BRANDS



ABRASIVE ROLLS

pg 249



BRISTLE DISCS

pg 249



ABRASIVE WHEELS

pg 250



BUFFERS

pg 251



BENCH GRINDERS

pg 251



ABRASIVE AND POLISHING ACCESSORIES

pg 252



SOLDERING IRONS

pg 253



WELDERS

pg 254



WELDING HELMETS

pg 254



WELDING GLOVES

pg 254







**3M Sanding Hand Pads**

- 6" x 9"
- Non-woven

Q #	grade	abrasive	color	price
G0511472	very fine	aluminum oxide	maroon	\$1.06
G1777142	medium	aluminum oxide	tan	\$2.56
G0373511	medium	silicon carbide	gray	\$1.79

**NORTON Sanding Hand Pad**

- Aluminum oxide abrasive
- Non-woven
- Very fine grade
- 6" x 9"
- Green

Q #	price
G3401203	\$0.33



**NORTON T414 Sanding Sheets**

- Silicone carbide abrasive
- A-weight waterproof paper backing
- 9" x 11"
- 50 pack

Q #	grit
G1154781	220
G1121102	280
G1702671	320
G3194432	400
G1335476	500
G1838654	600

each **\$40.00**

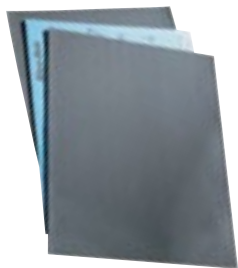

**NORTON Metalite R228 Sanding Belts**

- Aluminum oxide
- X-weight cloth backing

Q #	size	grit	price
G3364602	1" x 42"	80	\$1.19
G1968653	1" x 42"	120	\$1.19
G2700634	2" x 48"	60	\$3.27
G0456477	2" x 48"	80	\$3.27
G3246047	6" x 48"	80	\$7.70
G1226057	6" x 48"	120	\$7.70



**NORTON PSA Sanding Disc Rolls**

- Stearated coating
- Aluminum oxide abrasive material
- C-weight paper backing
- 100 discs per roll

**5" Diameter**

Q #	grit
G0276841	60
G2220592	80
G2489627	120

each **\$24.46**

**6" Diameter**

Q #	grit
G0871945	60
G1674705	80
G3145405	120

each **\$30.83**

**3M Surface Conditioning Discs**

- Aluminum oxide abrasive
- Non-woven
- Scotch Brite series



**Hook and Loop Discs**

Q #	disc dia	grade	price
G2916654	2"	coarse	\$0.87
G1229934	4"	coarse	\$2.82
G3126401	7"	coarse	\$5.28

**Locking Discs**

Q #	disc dia	grade	price
G1065687	3"	medium	\$1.77
G1709897	3"	very fine	\$2.05

**NORTON BlueFire R821P Sanding Belts**

- Zirconia aluminum oxide abrasive
- Cloth backing
- 6" x 48"

Q #	grit
G2830651	36
G0791436	40
G3125062	50
G2773206	60
G1730924	80

each **\$9.01**

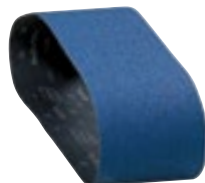

**NORTON R228 PSA Sanding Discs**

- Aluminum oxide abrasive
- X-weight cloth backing
- 12" disc diameter

Q #	grit
G0694321	60
G2934102	80
G0909736	120

each **\$5.84**



**ARC ABRASIVES ZK Conditioning Discs**

- 2" disc diameter
- Roll on/off attachment
- Non-woven
- Aluminum oxide abrasive
- 25,000 max rpm

Q #	grade	color
G1996111	medium	maroon
G1772495	coarse	brown

each **\$0.87**

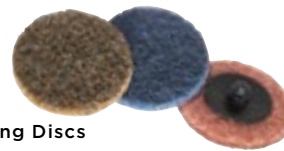

**3M Tapered Bristle Discs**

- Ceramic aluminum oxide abrasive

**2" dia**

Q #	grit	color
G1046403	50	green
G2230401	80	yellow
G0664851	120	white

each **\$6.60**

**3" dia**

Q #	grit	color
G2564475	50 grit	green
G0508191	80 grit	yellow
G3382452	120 grit	white

each **\$9.91**

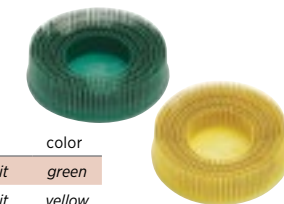

**3M Bristle Discs**

- 4 1/2" diameter
- 3/4" trim length
- 5/8"-11 INT mounting size
- Ceramic aluminum oxide abrasive
- 12,000 max rpm

Q #	color	grit
G0387301	green	50
G1290161	yellow	80

each **\$20.83**





# ABRASIVES



### MERIT Type 29 Arbor Mount Flap Discs

- 7/8" mounting hole
- Zirconium aluminum oxide
- 4 1/2" diameter
- Fiberglass backing
- 13,300 max rpm

Z#	grit
G0805917	40
G2539214	60
G2389947	80

each **\$3.39**

### NORTON Type 27 Gemini Grinding Wheels

- Aluminum oxide abrasive
- 4 1/2" diameter
- 13,580 max rpm

#### 24 Grit

- For stainless steel, steel and other ferrous metals

Z#	arbor size	price
G3279412	7/8"	<b>\$1.67</b>
G3481572	1 1/8"-11	<b>\$3.23</b>

#### 46 Grit

- For aluminum and soft metals

Z#	arbor size	price
G1018026	7/8"	<b>\$5.65</b>
G0666522	1 1/8"-11	<b>\$6.54</b>



### UNITED ABRASIVES-SAIT Type 27 Depressed Center Wheels

- Aluminum oxide abrasive
- 24 grit
- 4 1/2" diameter
- 1/4" thickness
- 7/8" arbor size
- For ferrous metals

Z#	series
G1031861	A24N
G0739234	A24R

each **\$1.97**



### DEWALT Type 1 Straight Grinding Wheel

- Aluminum oxide abrasive
- 6" diameter
- Cut off
- 7/8" arbor size
- 10,100 max rpm

Z#	price
G0370632	<b>\$2.10</b>



### PFERD Grinding Wheels

- Ceramic abrasive
- D-weight vulcanized fiber backing
- 16 grit
- Coarse
- Quick change attachment
- 25 pack

#### 4 1/2" Disc Diameter

- 13,300 max rpm

Z#	color
G7605753	blue
G7482255	gray

price **\$116.47**

#### 5" Disc Diameter

- 13,200 max rpm

Z#	color
G7591717	blue
G7602953	gray

price **\$125.85**

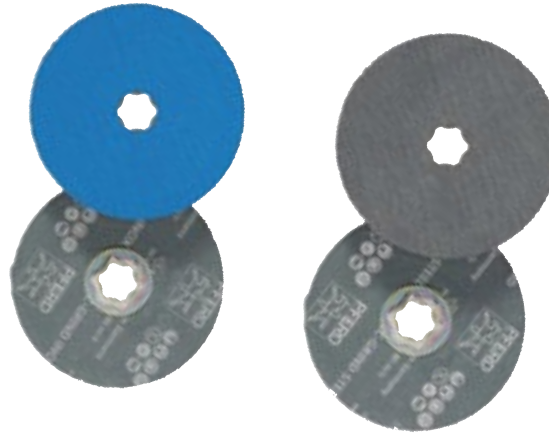

### NORTON Type 27 Gemini Cut-Off Wheels

- Aluminum oxide abrasive
- 24 grit
- 0.045" thickness
- 7/8" arbor size
- For ferrous metals

Z#	dia	max rpm	price
G0322752	4 1/2"	13,580	<b>\$1.75</b>
G3072937	5"	12,225	<b>\$3.56</b>
G0845932	6"	10,185	<b>\$3.65</b>



### VALUE BRAND Spiral Sewn Buffing Wheels

- Sisal
- 1/2" thickness
- 1" arbor hole

Z#	dia	price
G4177381	6"	<b>\$4.56</b>
G3920901	8"	<b>\$5.98</b>



### ARC ABRASIVES Mounted Flap Wheels

- Aluminum oxide abrasive
- 25,000 max rpm
- 1 1/2" diameter
- 1" width

Z#	grit	price
G0691101	40	<b>\$1.89</b>
G1147955	60	<b>\$1.99</b>
G2153977	80	<b>\$2.52</b>
G3396407	120	<b>\$2.65</b>
G2375423	180	<b>\$1.99</b>



### MERIT Mounted Flap Wheels

- Aluminum oxide abrasive
- Straight 1/4" shank

#### 1" Diameter

- 30,000 max rpm

Z#	grit
G0400373	60
G3089152	80
G3238611	120

each **\$2.40**

#### 2" Diameter

- 25,000 max rpm

Z#	grit
G2932203	60
G2403554	80
G1020853	120

each **\$3.77**

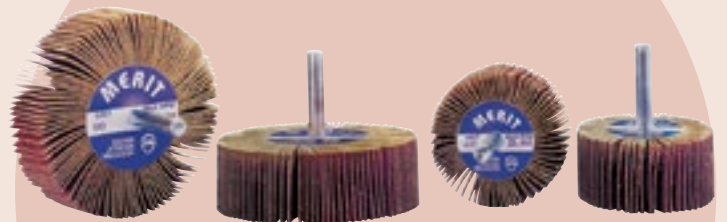

See more abrasive wheels on page 161



**JET**  
**1 HP Bench Grinder**  
 • 115V  
 • 3450 max rpm  
 • Aluminum oxide  
 • 1" wheel width, 8" wheel dia  
 • 36 and 60 grit

#	price
G4404346	<b>\$246.17</b>

**WESTWARD**  
**Deburring Tool Kit**  
 • Features blade storage in handler  
 • Extends from 1/2" to 5"

**B Series**  
 • Can be inserted at 90° angle  
*includes handle with depress-type locking button, B-10 and B-20 blades*

#	price
G1532763	<b>\$14.71</b>

**E Series**  
*includes handle, telescoping blade holder, E-100, E-200, and E-300 blades*

#	price
G2007135	<b>\$16.37</b>



**WESTWARD**  
**Sandblaster**  
 • Pressure-feed  
 • 125 lb hopper capacity  
 • 12.4" x 26.7" tank  
 • CFM required @ 80 psi  
 9 with 3/32" nozzle,  
 11 with 7/64" nozzle,  
 13 with 1/8" nozzle,  
 18 with 3/16" nozzle

#	price
G3953293	<b>\$278.67</b>



**DAYTON**  
**3/4 HP Bench Grinder**  
 • 115/230V  
 • 3450 max rpm  
 • 1" wheel width, 8" wheel dia  
 • Aluminum oxide wheel  
 • 36 and 60 grit

#	price
G1762144	<b>\$227.84</b>



**ECONOLINE**  
**Dust Collector**  
 • Bag-style filter  
 • 100 cfm max flow  
 • 59" overall height  
 • 15" depth  
 • 8' electric cord plugs into cabinet light box

#	price
G2911352	<b>\$363.95</b>



**DAYTON**  
**8" Bench Top Buffer**  
 • 2000 to 3300/3450 rpm  
 • 3/4 HP  
 • 120V  
 • Capacitor start motor  
 • Steel motor housing

#	price
G2894464	<b>\$189.66</b>

**DAYTON**  
**Buffing Compound Bars**  
 • 580g-620g  
 • 4 pack

#	color	application	price
G2116545	white	chrome, iron, stainless steel	<b>\$12.10</b>
G0491827	red	brass, gold, platinum, silver	<b>\$12.57</b>
G1667863	black	iron, steel	<b>\$12.60</b>



**DAYTON**  
**Bench Grinder and Buffer Stand**  
 • Heavy cast iron with 3 1/2" steel column and removable cast iron water pot  
 • 14 1/2" x 16 1/4" base  
 • 10" x 11" table  
 • 31 3/4" height  
 • For use with most bench grinders and buffers

#	price
G0993937	<b>\$135.71</b>



**DAYTON**  
**10" Bench Top Buffer**  
 • 1725/3450 rpm  
 • 1/1.5 HP  
 • 120V  
 • Cast iron motor housing  
 • TEFC motor

#	price
G0931314	<b>\$539.92</b>

**MAXUS**  
**Portable Sandblaster**  
 • Siphon-feed  
 • 30 lb hopper capacity  
 • Polyethylene  
 • 40 to 125 psi  
*includes 5' hose, blast gun and 3/16" ceramic nozzle*

#	price
G3342211	<b>\$58.85</b>





# ABRASIVES

MORE THAN 800,000 ITEMS ONLINE

### VALUE BRAND Blasting Media

- Aluminum oxide
- 50 lb

Z#	grit	nominal dia micron range	price
G3006464	120	53 to 125	<b>\$59.99</b>
G2968472	100	63 to 150	<b>\$70.04</b>
G2531462	80	106 to 212	<b>\$65.03</b>



### BALLOTINI Glass Bead Blast Media

- 53 lb
- OSHA STANDARDS

Z#	grade	nominal dia micron range
G1248895	fine	90 to 150
G3365415	medium	106 to 212
G2903022	coarse	125 to 250

each **\$57.87**



### ALC Abrasive Strainer

- 1 piece construction
- Metal
- For use with all blasting media

Z#	price
G4292382	<b>\$18.24</b>



### ALC Rubber Blast Gloves

- 18" length
- One size fits most
- Rubber
- 1 pair

Z#	price
G4292443	<b>\$30.55</b>



### BORA Combination Grit Sharpening Stone

- Aluminum oxide abrasive
- 220/1000 grit
- Coarse/fine grade
- 2" w x 6" l x 1" h

Z#	price
G3999204	<b>\$4.43</b>



### NORTON Oilstone Sharpening Kit

- 5 pieces
- Silicone carbide and aluminum oxide abrasive
- 120/220/400 grit
- includes (1) each coarse, medium and fine oilstone, angled wedge and 4.5 oz oil and case*

Z#	price
G0864175	<b>\$98.79</b>



### NORTON Knife Blade Sharp File

- Hard Arkansas abrasive
- Fine grade
- 4" x 1"
- Translucent white

Z#	price
G3452775	<b>\$10.53</b>



### DAYTON Eye Shield Kit

- Polycarbonate
- 5.75" face width
- For use with most bench grinders
- includes (2) plexi eyeshields, (2) lower eyeshield brackets and (4) 1024 X 3/8" pan head screws*

Z#	price
G2894455	<b>\$12.98</b>



### DAYTON Grinding Wheel Dresser

- 2 3/8" diameter
- 0.930" face width
- 14 1/2" length
- For use with grinding wheels up to 3" width

Z#	price
G0909176	<b>\$22.87</b>



### NORTON Single Point Tool

- BC
- 3/4 carat
- 7/16" x 2"
- 0.0015" max tool
- 8 to 10" per minute traverse speed

Z#	price
G3499912	<b>\$64.41</b>



### VALUE BRAND Mounted Felt Bob

- Olive shape
- MS-5 Series
- Hard density
- 1/2" head dia
- 35,000 max rpm

Z#	price
G3491765	<b>\$1.68</b>



### CLESCO Wheel Mandrel Adapters

- 1/4" max wheel width
- 3/4" washer outer diameter
- 2" length

Z#	fits	price
G2428273	1/4" hole	<b>\$3.78</b>
G1285882	3/8" hole	<b>\$3.78</b>
G1311554	1/4" or 3/8" hole	<b>\$6.60</b>



**WELLER Soldering Station**

- Temperature controlled
- 60 W
- 350° to 850° F temperature range
- 120 V
- Designed for continuous production soldering
- Innovative heater/sensor combination provides rapid heatup and temperature recovery

#	price
G0743032	<b>\$103.51</b>



**WELLER Soldering Station**

- Variable control solder station
- 5-40 W
- 900° F
- 120 V

features lightweight soldering pencil

#	price
G0538632	<b>\$38.82</b>



**WELLER Soldering Iron**

- 50 W
- Temperature rating 350° to 850° F
- 24 V

features non-burnable silicone rubber cord

#	price
G1788157	<b>\$33.61</b>



**WELLER Iron Stand Assembly**

- For soldering stations
- Use with 100W tools and irons with barrels up to 1 9/32" diameter

#	price
G0295671	<b>\$15.98</b>



**WELLER Soldering Gun Kit**

- 200 W
- Built-in lamp
- 6' 2-wire cord

includes pre-tinned copper tip, two extra untinned copper tips curved and smooth, flux brush, soldering aid tool, coil of 40/60 rosin-core solder and blow molded carrying case

#	price
G3325016	<b>\$44.17</b>



**BERNZOMATIC Brazing Alloy Rod**

- Bronze material
- 3/32" diameter
- 18" length
- 1595° to 1620° F brazing range

includes flux coating

#	price
G1133194	<b>\$11.83</b>

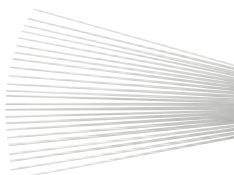

**BERNZOMATIC Brazing Torch**

- Trigger igniter
- Propane/mapp fuel
- Adjustable swirl flame
- MAPP gas soft solder 1/4" to 7"
- Propane gas silver braze 1/4" to 3/4"

#	price
G2641956	<b>\$38.36</b>



**WELLER Soldering Iron Kit**

- Butane power source
- 850° F
- Run time approximately 60 min
- 25 to 75 W
- Piezo ignition

includes iron with (4) tips soldering/mini blow torch/hot knife/hot air, deflector, sponge and tray and case with tool holder

#	price
G1097941	<b>\$52.34</b>



**BERNZOMATIC Brazing Alloy Rod**

- Copper phosphorous
- 1/8" diameter
- 18" length
- 1310° to 1460° F brazing range
- 90,000 psi tensile strength

#	price
G2663841	<b>\$16.49</b>



**WORTHINGTON Lead Free Solder**

- General plumbing
- Potable water applications
- 1lb spool
- 0.118" wire diameter

#	contents	price
G1606841	95% tin, 5% antimony	<b>\$22.99</b>
G1703825	tin, copper, selenium	<b>\$25.35</b>
G2798537	tin, copper, silver	<b>\$31.99</b>



**WORTHINGTON Rosin Core Lead Solder**

- Used for speaker wire, motors, appliances and general wiring
- ■ ASTM STANDARDS

#	contents	diameter
G2478463	60% tin and 40% lead	0.031"
G1360947	60% tin and 40% lead	0.032"
G1206387	40% tin and 60% lead	0.062"

each **\$21.97**



**TURBOTORCH Air/Acetylene Kit**

includes AR-B regulator, WA-400 handle, AH-12 hose, S-4 tip, instruction manual and gauge guard

#	price
G0293885	<b>\$159.62</b>





# WELDING

MORE THAN 800,000 ITEMS ONLINE

### MILLER ELECTRIC XL AC/DC Welder

- 225/150V, AC/DC
  - 230V input
  - 12 3/4" w x 17 1/2" d x 18 3/4" h
- includes 6' power cord with plug



Z#	price
G2265961	<b>\$698.30</b>

### ARCAIR DC Copperclad Electrodes

- Graphite, copper, carbon
- 12" length
- 50 pack

Z#	dia	price
G0919651	1/4"	<b>\$14.92</b>
G0606383	5/16"	<b>\$15.46</b>
G1285706	3/8"	<b>\$21.05</b>



### FIBRE-METAL Passive Welding Helmet

- 10 lens shade
  - 4 1/4" x 2" lens
  - Fiberglass material
  - ■ ANSI & CSA STANDARDS
- includes shade ten filter lens installed



Z#	price
G0946845	<b>\$49.19</b>

### MILLER ELECTRIC Mask Respirator

- The ellipse mask together with ellipse HEPA air filters (included) give protection against hazardous and toxic dust particles, fumes and mist metal
- Fits easily under most welding helmets
- Large non-return exhaust valve for reduced user fatigue
- ■ NIOSH STANDARDS



Z#	price
G4608362	<b>\$24.92</b>

### LINCOLN ELECTRIC Canvas Cover

- Made from flame retardant, mildew resistant and water repellent red canvas
- For use with Lincoln Electric compact wire, MIG and some TIG welders



Z#	price
G3552875	<b>\$32.90</b>

### STEINER Welding Blanket

- Carbonized fiber material
- 0.150" to 0.200" thickness
- 16 oz/sq-yd material weight
- 4' x 6'
- ■ ANSI FM 4950 STANDARDS



Z#	price
G1264837	<b>\$66.03</b>

### MILLER ELECTRIC MIG Welder

- 208/230VAC input
- Mild steel, aluminum construction
- 60Hz
- 19" w x 40" d x 30" h

includes 15' 250 A M-25 gun, 10' work cable with clamp, argon mix regulator/flow gauge with 7' hose, power cord and plug, running gear and cylinder rack, .030/.035" reversible dual groove drive rolls, contact tips, thickness gauge and features auto set, gun-on-demand and spool gun ready for aluminum applications



Z#	price
G1343072	<b>\$2,052.28</b>

### MILLER ELECTRIC Auto Darkening Welding Helmet

- 8 to 12 lens shade
- 3 3/4" x 1 1/8" plate dimension
- Nylon construction
- Battery with solar assist power source

includes (2) AAA batteries, magnifying lens holder, (5) outside and (2) inside cover lenses



Z#	price
G4578357	<b>\$88.12</b>

### MILLER ELECTRIC Welding Lens

- 2" x 4" plate size
- For use with 2 x 4 auto-darkening lens (shade 9)
- ■ ANSI & CSA STANDARDS



Z#	price
G4553534	<b>\$87.24</b>

### SAFETUBE Welding Screens

- Transparent vinyl
- 0.014" thickness
- Withstands 150° F
- Protects from harmful UV rays and sparks for the casual viewer
- Reduces visible flash and allows light into work area

includes square tube frame, legs, curtain and plastic ties



Z#	size	color	price
G0158575	6' x 6'	yellow	<b>\$82.68</b>
G0158532	8' x 6'	orange	<b>\$104.99</b>
G0158566	8' x 6'	charcoal gray	<b>\$104.99</b>



### CONDOR Welding Bib Apron

- Leather
- Webbing and snap buckle closure type
- 24" x 36"



Z#	price
G1571805	<b>\$23.84</b>

### HOBART MIG Welding Wires

- Carbon steel



### ER70S-2 Solid Wire

- Used on dirty or rusty steels primarily for single pass applications

Z#	dia	spool	price
G3520237	0.030"	2 lb	<b>\$15.42</b>
G3537965	0.035"	2 lb	<b>\$15.42</b>
G3520587	0.030"	11 lb	<b>\$80.65</b>
G3540442	0.035"	11 lb	<b>\$80.65</b>

### ER70S-3 Solid Wire

- Used for sheet metal applications for single or multiple pass



Z#	dia	spool	price
G3533311	0.030"	2 lb	<b>\$11.99</b>
G3557337	0.035"	2 lb	<b>\$11.99</b>
G3547004	0.030"	11 lb	<b>\$50.71</b>
G3526311	0.035"	11 lb	<b>\$50.71</b>

### ER70S-6 Solid Wire

- Can be used on sheet metal or fabrication applications where a smooth weld bead is desired



Z#	dia	spool	price
G3519923	0.025"	11 lb	<b>\$48.40</b>
G3523974	0.030"	11 lb	<b>\$48.40</b>
G3539916	0.035"	11 lb	<b>\$48.40</b>
G3520632	0.030"	33 lb	<b>\$67.99</b>
G3538421	0.035"	44 lb	<b>\$86.99</b>

### TILLMAN Stick Welding Gloves

- Elkskin palms
- Cowhide backs and cuffs
- Reinforced thumb
- 14" length



Z#	size
G0130444	small
G0130453	medium
G0130462	large
G0130471	extra large

each **\$17.97**

**SPOTCHECK Dye Penetrant Developer**

- White
- 9 oz aerosol can
- For detecting cracks and leaks in metal surfaces, lifting devices, automotive parts, valves, pipes, pressure vessels and tanks, tool shops, fire departments and amusement parks
- 65 sq-ft coverage

#	price
G1221552	<b>\$15.14</b>



**SPOTCHECK Dye Penetrant Remover**

- Clear
- 10.6 oz aerosol can
- For detecting cracks and leaks in metal surfaces, lifting devices, automotive parts, valves, pipes, pressure vessels and tanks, tool shops, fire departments and amusement parks
- 65sq-ft coverage

#	price
G3332944	<b>\$12.71</b>



**UNIWELD Soapstone**

- Produce highly visible layout lines on metal or concrete
- Holders include built-in sharpener and pocket clip
- 144 pack

#	type	price
G1388091	flat	<b>\$13.22</b>
G3352492	round	<b>\$14.54</b>



**CHEMTRONICS Ultrajet 70 Duster**

- For printed circuit boards, office equipment, A/V equipment, lab instrumentation, medical devices, PLCs, contacts, TV and VCR internals

#	price
G2305475	<b>\$10.13</b>



**CHEMTRONICS Flux Remover**

- Aerosol
- 16 oz size
- 10 oz net weight
- Flammable, industrial strength, contains no HCFCs, HFCs, HAPs, or nPB
- Cleans type R, RMA, RA and rosin-based no clean solder fluxes
- Removes waxes and similar contaminants found in electronic manufacturing and repair

#	price
G0728235	<b>\$13.78</b>



**SURFOX 5 pack Cleaning Brushes**

- Standard size
- Highly conductive
- Used with SURFOX system for cleaning weld discoloration on stainless steel

#	price
G4994446	<b>\$200.39</b>



**MAGNAFLUX White Contrast Paint**

- For use with yoke inspection kit

#	price
G3664561	<b>\$14.84</b>



**CHEMTRONICS Overcoat Pen**

- Applies a tough, acrylic, conformal coating to protect conductive pen traces or repair permanent solder mask
- Green
- 4.9 g (0.16 oz)

#	price
G1115667	<b>\$15.02</b>



**AQUASOL Aluminum Tape**

- A purge gas retaining tape
- MIG/TIG welding, purging, HVAC, electrical and maintenance applications
- Coated aluminum foil
- 2" x 75'

#	price
G4408652	<b>\$27.72</b>



**VALUE BRAND Single Flint Lighter**

- Ignites tips on torches and cutting attachments
- For torch lighting and maintenance

includes flint renewals and tip cleaner

#	price
G1468266	<b>\$4.81</b>



**VALUE BRAND Triple Flint Lighter**

- Ignites tips on torches and cutting attachments
- For torch lighting and maintenance

includes flint renewal

#	price
G0790352	<b>\$3.09</b>



**SPOTCHECK Pendant Kit**

- For detecting cracks and leaks in metal surfaces, lifting devices, automotive parts, valves, pipes, pressure vessels and tanks, tool shops, fire departments and amusement parks

includes one each of G2350537 and G1221552, two cans of G3332944, handy paint marker, hand wipes and instructions

#	price
G1260612	<b>\$76.15</b>



**VALUE BRAND Spill Kit**

- 2 gal volume absorbed per pkg
- Universal/maintenance fluids absorbed

includes (6) pillows, (2) 12" x 14" Kimtex wipes, (1) pair of nitrile gloves (size 10), (24) content tags, (1) 17" x 30" disposal bag, (1) 4" red vinyl twist tie, (1) pair of silvershield gloves (size L), (1) warning label and (1) pocket spill response guide

#	price
G3917627	<b>\$43.13</b>





# FASTENERS, DOOR & CABINET HINGES & RAW MATERIALS



## TOP BRANDS



### SCREWS

pg  
257



### NUTS

pg  
261



### PINS

pg  
262



### WASHERS

pg  
263



### DOOR CLOSERS

pg  
264



### HINGES

pg  
264



### BOLTLOCKS

pg  
266



### BRACES

pg  
267



### METAL

pg  
268



### PLASTIC AND RUBBER

pg  
269





**VALUE BRAND**  
**Carbon Steel**  
**Hex Head Cap Screws**

- Zinc plated
- Fully threaded
- ¼"-20
- 100 pack

#	thread size	thread length	price
G3220314	¼"	½"	<b>\$3.18</b>
G1000316	¼"	¾"	<b>\$3.59</b>
G3016176	1"	1"	<b>\$4.37</b>
G0961046	1¼"	1½"	<b>\$5.30</b>



**VALUE BRAND**  
**Stainless Steel Hex Head Cap Screws**  
• 18-8 stainless steel

**Fully Threaded**

#	thread size	thread length	pack	price
G4711095	⅜"-16	1¼"	25	<b>\$7.63</b>
G4710501	½"-13	1½"	10	<b>\$6.70</b>

**Partially Threaded**

#	thread size	thread length	pack	price
G4727414	⅜"-16	1"	10	<b>\$3.56</b>
G4706301	½"-13	1¼"	5	<b>\$4.29</b>



**VALUE BRAND**  
**Button Head Hex Socket Cap Screws**

- Black oxide carbon steel
- Fully threaded
- 100 pack

#	thread size	thread length	price
G3319312	6-32	¾"	<b>\$1.30</b>
G3151784	6-32	⅝"	<b>\$1.42</b>
G1273221	¼"-20	½"	<b>\$4.15</b>
G0850832	¼"-20	¾"	<b>\$4.83</b>



**TAMPER-PRUF SCREW**  
**Tamper Resistant Button Head**  
**Machine Screws**

- 18-8 stainless steel
- Torx drive
- 25 pack

#	thread size	thread length	driver size	price
G1579575	8-32	½"	T15	<b>\$10.12</b>
G2930374	¼"-20	½"	T27	<b>\$11.31</b>
G0361715	¼"-20	1"	T27	<b>\$12.96</b>



**VALUE BRAND**  
**Pan Head Machine Screws**

- Carbon steel
- Phillips drive
- 100 pack

#	thread size	thread length	driver size	price
G1037811	6-32	⅝"	#2	<b>\$1.84</b>
G3239415	6-32	1"	#2	<b>\$2.49</b>
G2507102	10-24	½"	#2	<b>\$2.59</b>
G0827531	10-24	1"	#2	<b>\$3.72</b>
G1995621	¼"-20	½"	#3	<b>\$4.26</b>
G2562384	¼"-20	1¼"	#3	<b>\$6.96</b>



**VALUE BRAND**  
**Flat Head Machine Screws**

- Carbon steel
- Slotted drive

#	thread size	thread length	pack	price
G0904382	10-24	⅞"	100	<b>\$2.81</b>
G1766037	¼"-20	½"	100	<b>\$3.72</b>
G1990177	¼"-20	1"	100	<b>\$5.29</b>
G1154641	½"-13	1½"	50	<b>\$17.40</b>



**VALUE BRAND**  
**Stainless Steel Drilling Screws**

- Hex washer head

#	thread size	thread length	driver size	pack	price
G3382251	8-18	1¼"	¼"	100	<b>\$11.31</b>
G0285083	¼"-14	¾"	⅜"	50	<b>\$15.07</b>
G1515087	¼"-14	2"	⅜"	25	<b>\$11.77</b>



**VALUE BRAND**  
**Steel Drilling Screws**

- Zinc plated
- Hex washer head
- ⅝" driver size
- 10-16 thread size

#	thread length	pack	price
G2207624	¾"	157	<b>\$3.39</b>
G1595237	1"	130	<b>\$5.65</b>



**VALUE BRAND**  
**Steel Wood Screws**

- Zinc plated
- Flat head
- Phillips drive
- 1¼" thread length
- 100 pack

#	screw size	driver size	price
G0602454	#4	#1	<b>\$1.96</b>
G1177504	#6	#2	<b>\$2.32</b>
G2158597	#8	#2	<b>\$3.00</b>
G1242026	#10	#3	<b>\$3.43</b>
G1748792	#12	#3	<b>\$4.90</b>
G1369137	#14	#3	<b>\$4.64</b>



**VALUE BRAND**  
**Spade Head Steel Thumb Screws**

- Zinc plated

#	thread size	thread length	pack	price
G2486443	10-24	½"	25	<b>\$2.53</b>
G1605387	¼"-20	¾"	25	<b>\$4.25</b>
G1431281	⅝"-18	1½"	5	<b>\$7.84</b>



# FASTENERS

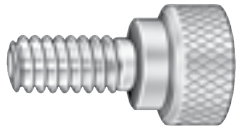

### VALUE BRAND Knurled Head Steel Thumb Screws

- Black oxide

#	thread size	thread length	price
G1148953	10-32	½"	<b>\$3.93</b>
G2792255	¼"-20	¾"	<b>\$4.57</b>
G3047055	⅝"-18	1"	<b>\$4.70</b>

### VALUE BRAND Metric Machine Screw Assortments

- Zinc plated steel
- Pan head
- Phillips drive

#	no of pieces	no of sizes	size range	thread lengths	price
G0563796	42	7	M4-0.70, M5-0.80, M6-1.00	12 to 20 mm	<b>\$2.10</b>
G2471086	214	18	M3-0.50 to M6-1.00	6 to 40 mm	<b>\$14.99</b>

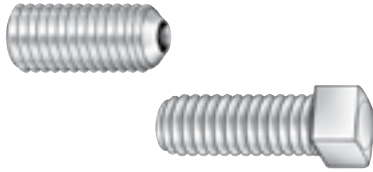

### VALUE BRAND Cup Point Socket Set Screws

- Alloy Steel**
- Hex socket drive
  - 100 pack

#	thread size	thread length	driver size	price
G3479296	¼"-20	¾"	⅜"	<b>\$3.81</b>
G3031567	⅝"-16	½"	⅝"	<b>\$9.88</b>
G2430766	⅝"-18	1"	⅝"	<b>\$14.44</b>

- Carbon Steel**
- Square drive
  - 100 pack

#	thread size	thread length	driver size	price
G2489636	¼"-20	1½"	¼"	<b>\$11.96</b>



### VALUE BRAND Deck Screws

- Bronze ceramic steel
- Star drive
- T25 driver size

#	screw size	thread length	pack	price
G2380567	#9	2½"	117	<b>\$6.75</b>
G0523582	#10	5"	221	<b>\$34.72</b>
G1873611	#9	3"	450	<b>\$28.96</b>
G3225162	#10	6"	191	<b>\$36.82</b>

941 PIECE

### VALUE BRAND Cap Screw Assortment

- 15 sizes
- Yellow zinc plated steel
- Hex head
- ¼"-20, ⅝"-18, ⅝"-16 sizes
- ½" to 2" thread lengths

#	price
G0263453	<b>\$128.31</b>



1,825 PIECE

### VALUE BRAND Drilling Screw Assortment

- 20 sizes
- Zinc plated steel
- Hex washer head
- #6 to ¼" sizes
- ½ to 1½" thread lengths
- ¼ to ⅝" driver sizes

#	price
G1993607	<b>\$128.31</b>



1,150 PIECE

### VALUE BRAND Machine Screw, Nut and Washer Assortment

- 16 sizes
- Zinc plated steel
- Round head
- #6 to ¼"-20 sizes
- ½ to 1½" thread lengths

#	price
G1962527	<b>\$32.99</b>



### VALUE BRAND Drywall Screws

- Black phosphate carbon steel
- Bugle head
- Phillips drive
- #2 driver size

#	screw size	thread length	pack	price
G2228642	#6	1"	352	<b>\$4.04</b>
G2800804	#6	1½"	221	<b>\$2.99</b>
G3454823	#6	2"	191	<b>\$3.49</b>
G0918294	#8	3"	102	<b>\$3.49</b>
G3215843	#8	2½"	112	<b>\$3.10</b>
G1179647	#8	3"	510	<b>\$12.99</b>

253 PIECE

### VALUE BRAND Drilling/Tapping Screw Assortment

- 11 sizes
- Zinc plated steel
- Hex washer and pan head
- Hex and Phillips drive

#	price
G1695005	<b>\$40.32</b>



200 PIECE

### ITW BEE LEITZKE Socket Set Screw Assortment

- 12 sizes
- Steel

#	price
G2012193	<b>\$38.19</b>



**STRONG-TIE  
Crimp Anchors**  
• Zinc plated steel

**Tie-wire**

Q #	dia	length	pack	price
G0750145	3/4"	1 1/2"	100	<b>\$65.97</b>

**1/4" Rod Coupler**

Q #	dia	length	pack	price
G1321521	3/16"	1 1/4"	100	<b>\$83.08</b>

**Mushroom**

Q #	dia	length	pack	price
G2442702	3/4"	1 1/2"	100	<b>\$32.92</b>
G3268237	3/8"	2"	25	<b>\$25.74</b>
G1548276	3/8"	3"	25	<b>\$27.26</b>



**VALUE BRAND  
Concrete Screw Anchors**  
• Zinc plated steel  
• Hex washer head

Q #	dia	length	pack	price
G3243782	3/8"	3"	50	<b>\$46.72</b>
G2511801	3/8"	4"	50	<b>\$56.08</b>
G2441774	1/2"	6"	20	<b>\$40.44</b>
G3389434	3/4"	4"	10	<b>\$51.33</b>



**WESTWARD  
Conical Screw Anchors**  
• Plastic

Q #	screw size	screw length	pack	price
G4275397	#6 to #8	3/4"	100	<b>\$2.39</b>
G4266342	#8 to #10	7/8"	100	<b>\$2.55</b>
G3901414	#10 to #12	1"	100	<b>\$2.55</b>
G4271897	#14 to #16	1 3/8"	50	<b>\$2.30</b>



**RED HEAD  
Wedge Anchors**  
• Carbon steel  
• Fully threaded

Q #	thread size	thread length	pack	price
G0430071	1/2"-13	2 3/4"	25	<b>\$15.15</b>
G2384855	1/2"-13	2 3/4"	25	<b>\$16.36</b>
G0778197	1/2"-13	3"	25	<b>\$17.35</b>
G0839334	3/8"-16	3 3/4"	50	<b>\$22.40</b>

**WESTWARD  
Hammer Drive Pin Anchors**

- Zamac
- 1/4" dia
- 100 pack



**Q #**      **length**      **price**

G4267374	1"	<b>\$18.96</b>
G4264495	1 1/4"	<b>\$21.21</b>
G4262702	1 1/2"	<b>\$26.52</b>
G4261205	2"	<b>\$30.50</b>



**GREENLEE  
Anchor Expanders**  
• Alloy steel

Q #	thread size	price
G1922042	1/4"-20	<b>\$44.32</b>
G0529557	3/8"-16	<b>\$67.83</b>



**WESTWARD  
Plug Anchors**

- Polyethylene anchors with screws

Q #	screw size	pack	price
G4101596	#6 to #8	100	<b>\$19.66</b>
G4268363	#10 to #12	50	<b>\$26.81</b>

**RED HEAD  
Anchor Kit**

- Plastic and steel
- Phillips drive
- 8-32 thread size
- 1 1/4" length
- 25 pack

Q #	price
G4306723	<b>\$6.44</b>



**WESTWARD  
Drywall Anchors**

- #6 to #10 screw size
- 1 1/2" screw length
- 100 pack

Q #	material	price
G4027335	<i>zamac</i>	<b>\$29.13</b>
G4265782	<i>plastic</i>	<b>\$20.24</b>

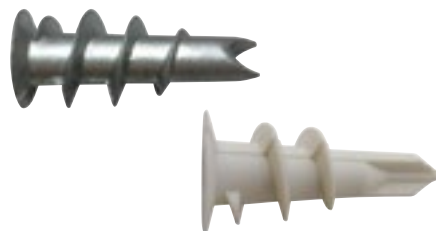

**MKT FASTENING  
Expansion Anchors**

**Sheet Metal Screw**

- Lead
- 50 pack

Q #	dia	length	screw size	price
G4438235	3/8"	1"	#16-18	<b>\$22.16</b>
G4438253	1/4"	1"	#6-8	<b>\$11.07</b>
G4438262	1/4"	1 1/2"	#6-8	<b>\$14.02</b>



**Lag Screw**

- Zinc alloy
- 25 pack

Q #	dia	length	screw size	price
G4456916	3/8"	1 3/4"	3/8"	<b>\$16.91</b>
G4456952	3/8"	2 1/2"	3/8"	<b>\$32.14</b>



**Machine Screw**

- Zinc alloy

Q #	dia	length	screw size	pack	price
G4455491	3/8"	1 1/2"	3/16"-18	25	<b>\$9.96</b>
G4457004	1 1/4"	4"	3/4"-10	5	<b>\$14.22</b>
G4457022	1"	3"	3/8"-11	5	<b>\$11.73</b>





# FASTENERS

MORE THAN 800,000 ITEMS ONLINE



### VALUE BRAND Anchor Bolts

- L-hook
- includes nut and washer

#### Carbon Steel

#	thread size	thread length	overall length	pack	price
G4271145	3/8"-16	2"	6"	25	<b>\$8.67</b>
G4266543	1/2"-13	2"	6"	25	<b>\$13.19</b>
G4267864	1/2"-13	2"	8"	25	<b>\$17.55</b>
G4267042	1/2"-13	2"	12"	25	<b>\$22.64</b>
G4455552	1-8	4"	18"	10	<b>\$92.42</b>

#### Hot Dipped Galvanized Steel

#	thread size	thread length	overall length	pack	price
G4455647	3/8"-16	1 3/4"	6"	50	<b>\$28.52</b>
G4456137	3/8"-11	3 3/4"	10"	25	<b>\$59.72</b>
G4455604	3/4"-10	3 3/4"	15"	20	<b>\$102.09</b>
G4460863	3/4"-10	3 3/4"	16"	20	<b>\$108.27</b>
G4456164	1-8	4"	18"	10	<b>\$113.29</b>



### WESTWARD Toggle Bolts

- Steel
- Mushroom head

#	bolt size	thread length	drill size	pack	price
G4276404	1/8"	1 3/32"	3/32"	50	<b>\$12.52</b>
G4231263	3/16"	2 1/8"	9/16"	50	<b>\$17.64</b>
G3887992	1/4"	3 3/8"	1 1/16"	50	<b>\$25.85</b>
G4260882	3/8"	2 3/8"	1"	25	<b>\$26.77</b>

### VALUE BRAND Square Neck Carriage Bolt

- Zinc plated steel
- 5/16"-18 thread size
- 4" thread length
- 50 pack

#	price
G2151764	<b>\$7.93</b>



### KEN FORGING Eyebolts with Shoulder

- Steel

#	thread size	thread length	ID	working load limit	price
G2235125	3/8"-16	1 1/4"	1"	1,300 lb.	<b>\$3.97</b>
G0349456	M24 x 3.00	63.5 mm	46 mm	3,850 kg	<b>\$24.41</b>



### BATTALION Eyebolts

- Zinc plated steel
- 20 pack

#	thread size	thread length	ID	price
G3461464	1/4"-20	2 3/32"	1/2"	<b>\$8.34</b>
G0617014	3/8"-16	2-1/8"	3 1/2"	<b>\$22.62</b>

### CHICAGO HARDWARE Eyebolts

- Zinc plated steel
- Turned wire
- 10 pack

#	thread size	thread length	ID	price
G1678896	1/4"-20	7/8"	1/2"	<b>\$2.29</b>
G1826465	1/4"-20	1 1/4"	1/2"	<b>\$2.49</b>
G3477241	1/4"-20	1 1/2"	1/2"	<b>\$2.99</b>
G2452432	3/8"-16	1 1/4"	3/4"	<b>\$4.99</b>
G0701181	3/8"-16	2 1/2"	3/4"	<b>\$8.59</b>

### BATTALION U-Bolts

Includes plate and nuts

#### Square Zinc Plated Steel

#	thread size	thread length	inside size	price
G3190327	3/8"	3"	4" x 5"	<b>\$7.46</b>
G1840307	3/8"	3 1/2"	4" x 6"	<b>\$7.79</b>
G3465481	3/8"	3"	2" x 5"	<b>\$5.79</b>

#### Round Stainless Steel

#	thread size	thread length	inside size	price
G1666673	1/4"	1 1/4"	1 3/8" x 2 1/2"	<b>\$5.49</b>
G0357987	3/16"	2 1/16"	2" x 4 1/2"	<b>\$13.92</b>



### KEN FORGING Rod Ends

- Drop forged steel
- 3 1/2" length

#	thread size	ID	price
G4433825	3/8"-16	3/8"	<b>\$6.56</b>
G4434866	3/16"-18	3/16"	<b>\$10.74</b>
G4433852	1/2"-13	1/2"	<b>\$7.35</b>



### VALUE BRAND Eyebolts with Shoulder

- Steel

#	thread size	thread length	ID	price
G4981112	3/8"-16	1 1/4"	1"	<b>\$2.48</b>
G4981155	M10 x 1.50	35.3 mm	27 mm	<b>\$4.79</b>



### VALUE BRAND Hex Nuts

- Grade 2**
- Hot dipped galvanized steel
  - UNC
  - 50 pack

#	thread size	width	price
G4269291	¼"-20	⅞"	<b>\$0.72</b>
G4260855	⅝"-16	⅞"	<b>\$1.48</b>
G4265947	⅝"-18	⅞"	<b>\$1.00</b>

### Grade 2H

- Steel
- UNC

#	thread size	width	pack	price
G4260706	¼"-20	½"	50	<b>\$1.25</b>
G4274916	¼"-13	⅞"	25	<b>\$3.85</b>

### Grade 5

- Zinc plated steel
- UNC
- 100 pack

#	thread size	width	price
G0791944	¼"-20	⅞"	<b>\$2.50</b>

### Grade 8

- Black oxide steel
- UNC

#	thread size	width	pack	price
G4261302	½"-13	¾"	25	<b>\$2.16</b>
G4273254	⅝"-16	⅞"	50	<b>\$1.81</b>

### Machine Screw

- Zinc plated steel
- 100 pack

#	thread size	width	thread type	price
G1822554	6-32	⅝"	UNC	<b>\$1.39</b>
G1872936	8-32	⅝"	UNC	<b>\$1.46</b>
G3189812	10-24	⅝"	UNC	<b>\$1.39</b>
G1173076	10-32	⅝"	UNF	<b>\$1.41</b>

### VALUE BRAND Threaded Rods

#### Acme Carbon Steel

#	thread size	thread length	price
G1605527	½"-10	3'	<b>\$6.99</b>
G0814755	½"-10	6'	<b>\$13.29</b>
G1456664	¾"-6	3'	<b>\$14.15</b>
G3264405	1"-5	6'	<b>\$31.99</b>

#### Stainless Steel

#	thread size	thread length	price
G0273567	¼"-20	3'	<b>\$3.18</b>
G1251957	⅝"-16	3'	<b>\$6.96</b>
G1575831	⅝"-16	6'	<b>\$12.71</b>



### VALUE BRAND Rod Coupling Nuts

- Zinc plated steel

#	thread size	thread length	thread type	price
G2358011	10-24	¾"	UNC	<b>\$2.53</b>
G0555974	¼"-20	⅞"	UNC	<b>\$2.55</b>
G2751052	⅝"-16	1¾"	UNC	<b>\$3.46</b>
G3388533	⅝"-24	⅞"	UNF	<b>\$4.40</b>

### VALUE BRAND Locknuts

- Zinc plated steel with nylon insert
- UNC
- 100 pack

#	grade	thread size	width	price
G2057614	2	6-32	⅝"	<b>\$2.80</b>
G2988431	2	8-32	⅝"	<b>\$2.47</b>
G0242724	2	¼"-20	⅞"	<b>\$3.67</b>
G1797801	8	¼"-20	⅞"	<b>\$3.74</b>
G1768523	2	⅝"-18	⅞"	<b>\$3.28</b>



### VALUE BRAND Acorn Nuts

#### High Crown

#	material	thread size	depth	thread type	pack	price
G1973605	steel	⅝"-16	⅝"	UNC	10	<b>\$5.00</b>
G3425161	steel	⅝"-11	⅝"	UNC	2	<b>\$4.78</b>
G2065734	zinc plated steel	6-32	⅝"	UNC	10	<b>\$2.17</b>
G2988282	zinc plated steel	8-32	⅝"	UNC	10	<b>\$2.17</b>
G1530785	zinc plated steel	¼"-28	⅝"	UNF	10	<b>\$3.04</b>
G1593444	zinc plated steel	½"-13	⅝"	UNC	3	<b>\$3.26</b>
G0484172	zinc plated steel	⅝"-18	⅝"	UNF	2	<b>\$4.78</b>

#### Low Crown

#	material	thread size	depth	pack	price
G2449386	steel	⅝"-24	⅝"	10	<b>\$3.69</b>
G1219687	steel	⅝"-24	⅝"	10	<b>\$4.78</b>
G3449381	stainless steel	½"-20	⅝"	3	<b>\$10.86</b>
G3466416	stainless steel	⅝"-18	⅝"	2	<b>\$10.65</b>



### VALUE BRAND Rivet Nuts

- Knurled flanged

#### Zinc Plated Steel

#	thread size	grip range	pack	price
G3466924	10-24	0.020" to 0.130"	100	<b>\$14.47</b>
G1724064	¼"-20	0.027" to 0.165"	50	<b>\$9.67</b>
G1275014	⅝"-16	0.027" to 0.150"	25	<b>\$12.21</b>
G0912852	⅝"-16	0.150" to 0.312"	20	<b>\$10.09</b>
G0605981	⅝"-18	0.027" to 0.150"	25	<b>\$10.85</b>

#### Aluminum

- UNC
- 50 pack

#	thread size	grip range	price
G0559081	10-24	0.130" to 0.225"	<b>\$9.49</b>
G3175121	¼"-20	0.027" to 0.165"	<b>\$9.56</b>



### WESTWARD Rivet Nut Kit

- Steel and aluminum

includes 16 each: ¼"-20, 12 each: #8-32, #10-24, #10-32, setting tool, nut mandrel and molded plastic case

#	price
G1968364	<b>\$98.81</b>

52  
PIECE



120  
PIECE

### VALUE BRAND Acorn Nut Assortment

- Low crown
- Stainless steel

#	price
G0480943	<b>\$145.89</b>



### VALUE BRAND Cap Nut

- Steel with black plastic cap
- ⅝" stud
- 10 pack

#	price
G0735086	<b>\$3.65</b>



### WESTWARD Blind Rivets

- Button head

#### Copper Rivet, Steel Mandrel

- 500 pack

#	dia	grip range	price
G0892534	⅝ (0.125)"	0.063" to 0.125"	<b>\$22.24</b>
G1308063	⅝ (0.125)"	0.188" to 0.250"	<b>\$16.72</b>

#### Aluminum Rivet, Aluminum Mandrel

#	dia	grip range	pack	price
G2549251	⅝ <sub>2</sub> (0.094)"	0.126" to 0.250"	500	<b>\$17.20</b>
G1508464	⅝ (0.125)"	0.063" to 0.125"	500	<b>\$15.84</b>
G0893076	⅝ <sub>16</sub> (0.187)"	0.251" to 0.375"	250	<b>\$18.14</b>
G2862806	⅝ (0.250)"	0.062" to 0.250"	100	<b>\$12.00</b>





# FASTENERS

MORE THAN 800,000 ITEMS ONLINE



### E-Z LOK Self Locking Thread Inserts

- Carbon steel
- For use on metal

Z#	internal	external	pack	price
G1102367	M8 x 1.25	½"-13	10	<b>\$8.35</b>
G2795746	¾"-16	¾"-12	10	<b>\$11.71</b>
G1353073	¾"-18	½"-13	10	<b>\$10.92</b>
G3340757	¾"-13	¾"-10	5	<b>\$6.61</b>



### HELICOIL Helical inserts

- Stainless steel
- Free running

Z#	internal	length	pack	price
G0319191	M2.5 x 0.45	2.5 mm	100	<b>\$28.41</b>
G0440851	M12 x 1.5	18 mm	6	<b>\$11.17</b>



### VALUE BRAND Hex Standoffs

- Aluminum
- 10 pack

- Male/Female**
- 10-32
  - ¾" width

Z#	length	price
G3661201	¾"	<b>\$7.84</b>
G3650981	1½"	<b>\$15.37</b>
G3713507	2"	<b>\$18.79</b>

**Female**

Z#	thread size	length	width	price
G3726676	#4-40	½"	¾"	<b>\$3.45</b>
G3689287	#4-40	¾"	¾"	<b>\$3.76</b>
G3657647	10-32	1"	¾"	<b>\$6.90</b>



### ITW BEE LEITZKE Pin Kits

Z#	cotter pin type	material	no. of sizes	no. of pieces	price
G2935843	clevis and hairpin	zinc plated steel	9	74	<b>\$20.11</b>
G2354292	hairpin	zinc plated spring wire	7	130	<b>\$21.90</b>
G0478956	extended prong	zinc plated steel	10	1,200	<b>\$38.37</b>

### VALUE BRAND Cotter Hairpins

- Zinc plated steel

Z#	dia	length	fits shaft dia	pack	price
G1193577	¾"	1½"	¾ to ¾"	100	<b>\$3.14</b>
G0475544	½"	1½"	¼ to ¾"	100	<b>\$3.46</b>
G1278243	¾"	1½"	¾ to ¾"	100	<b>\$3.12</b>
G2757404	½"	2¾"	½ to ¾"	50	<b>\$5.65</b>
G2178757	¾"	2½"	¾ to ¾"	50	<b>\$7.30</b>
G0837146	¾"	3¾"	¾ to 1"	25	<b>\$7.75</b>
G0973971	¾"	5"	1½ to 1½"	10	<b>\$7.80</b>



### MICRO PLASTICS Spacers

- Black nylon
- ½" OD

Z#	screw size	ID	length	price
G2382861	#8	0.171"	½"	<b>\$1.53</b>
G2139803	¼"-20	0.257"	¾"	<b>\$5.56</b>

### VALUE BRAND Clevis Pin

- Zinc plated steel
- ¾" dia
- ½" length
- 25 pack

Z#	price
G1775891	<b>\$4.29</b>



### VALUE BRAND Dowel Pins

- Alloy steel

Z#	dia	length	pack	price
G3074687	¼"	½"	100	<b>\$10.50</b>
G1465536	¾"	3"	10	<b>\$6.93</b>



### ITW BEE LEITZKE Detent Ring Pins

- Zinc plated steel
- 10 pack

Z#	dia	length	price
G1532675	¾"	1½"	<b>\$16.62</b>
G0453433	¾"	2"	<b>\$12.93</b>
G1877425	¾"	1"	<b>\$12.38</b>
G2889284	¾"	2"	<b>\$14.29</b>
G1989014	¾"	2½"	<b>\$16.32</b>



### ITW BEE LEITZKE Safety Pins

- Zinc plated spring wire
- Coiled tension
- 10 pack

Z#	usable length	overall length	price
G2035546	2½"	4¾"	<b>\$10.35</b>
G2320421	3¾"	5¾"	<b>\$12.33</b>

**VALUE BRAND**  
**Flat Washers**  
• Zinc plated steel

- SAE**  
• 0.0625" thickness  
• 100 pack

Q #	fits	ID	OD	price
G3414092	¼" bolts	⅝"	⅞"	<b>\$1.75</b>
G3550477	¼" bolts	⅝"	⅞"	<b>\$1.31</b>
G1874126	⅜" bolts	1⅜"	1⅝"	<b>\$6.46</b>

**USS**

Q #	fits	ID	OD	thickness	pack	price
G0624014	¼" bolts	⅝"	⅞"	0.0625"	100	<b>\$1.77</b>
G3543416	⅜" bolts	⅞"	1"	0.083"	50	<b>\$2.17</b>
G1447887	⅜" bolts	⅞"	1"	0.0781"	100	<b>\$3.45</b>
G1118257	⅝" bolts	⅞"	⅞"	0.0781"	100	<b>\$2.86</b>



**VALUE BRAND**  
**Fender Washers**  
• Zinc plated steel

- Zinc Plated Steel**  
• 0.051" thickness  
• ⅝" ID  
• Fits ¼" bolts  
• 100 pack

Q #	OD	price
G1907044	1"	<b>\$2.27</b>
G0606496	1¼"	<b>\$3.43</b>

**Stainless Steel**

- 0.050" thickness  
• Fits ¼" bolts  
• ⅝" ID  
• 1" OD  
• 25 pack

Q #	price
G3456232	<b>\$3.86</b>



**VALUE BRAND**  
**Split Lock Washers**  
• Zinc plated steel  
• 100 pack

Q #	fits	ID	OD	thickness	price
G3322496	¼" bolts	0.260"	0.487"	0.062"	<b>\$1.06</b>
G0544327	⅜" bolts	0.385"	0.680"	0.094"	<b>\$2.35</b>



**NORD-LOCK**  
**Lock Washers**  
• Carbon steel

Q #	fits	ID	OD	thickness	pack	price
G4344593	⅝" bolts	0.340"	0.530"	0.100"	20	<b>\$15.08</b>
G4344557	M6 bolts	0.260"	0.430"	0.070"	20	<b>\$14.23</b>
G4344645	M10 bolts	0.420"	0.830"	0.100"	10	<b>\$13.13</b>



**VALUE BRAND**  
**Retaining Rings**  
• Black phosphate carbon steel  
• 0.109" thickness  
• 5 pack

Q #	for shaft dia	free ID	price
G1740925	1½"	1.380"	<b>\$6.72</b>
G3004251	1¾"	1.608"	<b>\$7.25</b>



**VALUE BRAND**  
**Retaining Ring Assortments**  
• Phosphate steel

Q #	type	no of sizes	no of pieces	price
G1228683	external	21	273	<b>\$49.53</b>
G3101095	metric internal, external, and e-style	24	480	<b>\$56.46</b>

**VALUE BRAND**  
**Nails**

- Hot dipped galvanized steel  
• Flat head  
• Smooth shank

Q #	size	head dia	length	pack	price
G1275951	6d	⅜"	2"	1,160	<b>\$14.71</b>
G1393323	8d	⅜"	2½"	700	<b>\$14.73</b>
G1234852	10d	⅝"	3"	480	<b>\$14.72</b>
G1836536	12d	⅝"	3½"	420	<b>\$14.71</b>
G2064711	16d	1⅜"	3½"	355	<b>\$14.72</b>
G0708942	20d	⅞"	4"	50	<b>\$3.83</b>



**VALUE BRAND**  
**Key Stock**  
• Carbon steel  
• 12" length

Q #	size	price
G0886767	⅜" x ⅜"	<b>\$2.45</b>
G2619967	¼" x ¼"	<b>\$3.27</b>



**VALUE BRAND**  
**Deck Nails**  
• Stainless steel  
• Wire coil

Q #	shank dia	length	pack	price
G4673392	0.099"	1½"	3,600	<b>\$161.64</b>
G4679534	0.099"	1¾"	3,600	<b>\$177.84</b>
G4698452	0.099"	2"	3,600	<b>\$190.48</b>
G4668011	0.099"	2½"	3,600	<b>\$269.46</b>
G4705355	0.113"	2¾"	3,600	<b>\$253.25</b>
G4693787	0.120"	3"	1,800	<b>\$201.29</b>
G4683201	0.120"	3¼"	1,800	<b>\$251.57</b>
G4704533	0.131"	3"	1,800	<b>\$251.57</b>
G4690515	0.131"	3¼"	1,800	<b>\$273.13</b>





# HINGES & HARDWARE

MORE THAN 800,000 ITEMS ONLINE

## YALE

### Manual Door Closers

- Tri-pack mounting — regular, parallel and top jamb
- Adjustable spring sizes
- Aluminum housing
- 180° opening

■ UL, ANSI, ADA STANDARDS

*includes adjustable back check valve, closing speed valve, latching speed valve and mounting hardware*

#### 1100 Series

- Spring size 1 to 6
- 2 3/8" w x 9 1/8" l x 1 7/8" h

Z#	price
G0154113	\$132.29



#### 2700 Series

- Spring size 1 to 4
- 2 3/4" w x 13" l x 2 1/2" h

Z#	price
G0154217	\$84.32



## NORTON

### Hydraulic Door Closers

- Top frame mounting
- Adjustable spring sizes
- Aluminum housing
- 180° opening
- UL, ANSI, ADA STANDARDS

#### 1600 Series

- Spring size 1 to 4
- 2 7/8" w x 9 3/4" l x 2 3/8" h

Z#	price
G0035804	\$113.29



#### 7500 Series

- Spring size 1 to 6
- 2 1/8" w x 13 5/8" l x 3 7/8" h

*includes backcheck positioning valve*

Z#	price
G0035201	\$209.79



### BATTALION Sliding Door Box Tracks

- Galvanized steel construction
- 450 lb capacity
- 1 3/4" width
- 2 1/4" height
- Hardware NOT included

Z#	length	price
G0960224	6'	\$65.32
G2335514	8'	\$70.14
G1374143	10'	\$79.51
G1861002	12'	\$91.13



### AMERICAN GARAGE DOOR Vertical Track

- Galvanized steel
  - For use with 7' garage doors
  - Fits 2" rollers
- includes lock cut-out and holes for standard angle/bracket attachments*

Z#	price
G5004973	\$42.12



## BATTALION

### Bolt Hangers

- Bolt through the top of metal and wood-frame sliding doors
  - Steel with bright zinc finish
  - 450 lb capacity
  - 1 7/32" w x 4 5/8" l x 4" h
- includes hardware*

Z#	price
G1834445	\$20.02



## BATTALION

### Door Hanger Bracket Kit

- Bright zinc steel with nylon bearings
  - 450 lb capacity
  - 2 1/8" wheels
- includes (2) door hangers, (4) wall mount track brackets, (2) end caps and hardware*

Z#	price
G3258071	\$63.54

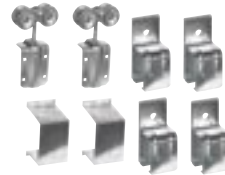

## BATTALION

### Strap Hangers

- Bolts to the face of solid wood doors
  - Steel with bright zinc finish
  - 600 lb capacity
  - 2 3/8" w x 4 5/8" l x 8 3/4" h
- includes hardware*

Z#	price
G2637442	\$26.35



## BATTALION

### Bracket End Cap

- Galvanized steel
- For use with box rail tracks
- 1 3/4" w x 2 1/4" l x 1 1/16" h
- Hardware NOT included

Z#	price
G0363623	\$3.39



## SOSS

### Invisible Hinges

- Zamac and steel construction
  - Full mortise mounting
  - 180° range of motion
  - ANSI/BHMA STANDARDS
  - ▶ MORE AVAILABLE ONLINE
- includes hardware*

#### Satin Chrome

Z#	size	price
G2734286	1 3/2" x 3 3/4"	\$18.20
G2939571	3 3/8" x 4 3/8"	\$28.86

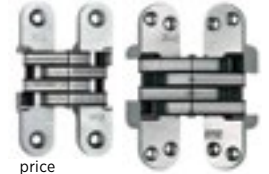

#### Satin Brass

Z#	size	price
G0802462	1 3/2" x 3 3/4"	\$18.20
G3148424	3 3/8" x 4 3/8"	\$28.86

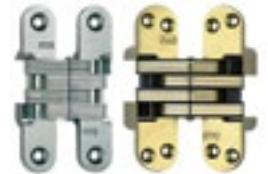

## ROCKWOOD

### Corner Guards

- Stainless steel
- .05" thickness
- 2" w x 2" d x 48" h

Z#	mounting	price
G1989601	screw-in	\$44.84
G1095692	adhesive	\$77.79



## VALUE BRAND

### Encased Round Base Magnets

- Ceramic ferrite magnet with steel casing
- Mounting hole in the center
- 32° F to 150° F stability range

Z#	magnet dia	hole dia	max pull	price
G3350602	2 7/11"	3/4"	65 lb	\$5.77
G1655227	3 3/8"	5/8"	95 lb	\$8.62



## VALUE BRAND

### Carabiner Hook Magnet

- Chrome plated neodymium magnet
- 45 lb working load limit
- 1.12" base dia

Z#	price
G1461966	\$10.32





**BATTALION  
Wall Base Molding**

- PVC vinyl molding
- Non-adhesive
- 60' l x 4" h
- Hardware NOT included

Q #	color	price
G3085354	black	
G2670753	gray	
each		<b>\$76.98</b>



**VALUE BRAND  
Door Sweeps**

- 5/8" nylon insert
- 1/4" w x 3 1/4" h
- **BHMA CERTIFIED**
- **MORE FINISHES AVAILABLE ONLINE**

Q #	sweep type	flange material	price
G2434634	triple fin	anodized aluminum	<b>\$10.33</b>
G1283554	brush	dark bronze aluminum	<b>\$13.78</b>



**VALUE BRAND  
EPDM Rubber Weatherstripping**

- For use on windows and doors
- Stays flexible to -40°F
- Adhesive backed, all profile mounting
- 1 1/2" x 10'

Q #	color	price
G0916727	white	
G1400646	black	
each		<b>\$12.52</b>



**VALUE BRAND  
Foam Seal Tape**

- Use with door frames and around windows to seal gaps
- PVC closed cell foam
- Self-adhesive mounting

Q #	dimensions	price
G1353931	1/2" w x 17' l x 3/4" h	<b>\$1.99</b>
G3486463	3/4" w x 10' l x 1/2" h	<b>\$2.89</b>



**PEMKO  
Silicone Smoke Seal Tape**

- For use with doors up to 36" w x 80" h
- Stays flexible from -58° to 450°F
- Self-adhesive mounting
- 1/2" w x 17' l x 3/8" h
- **UL AND BHMA STANDARDS**

Q #	color	price
G2515606	white	
G2419042	black	
each		<b>\$30.15</b>



**BATTALION  
Garage Door Bottom Weatherstripping**

- Aluminum flange with PVC vinyl insert
- Stays flexible to -30°F
- 5/16" insert, 1 1/2" x 1 1/16" flange
- Screw mounted
- includes hardware

Q #	length	price
G2125356	9'	<b>\$38.64</b>
G1157387	18'	<b>\$74.70</b>



**VALUE BRAND  
Magnetic Steel Door Weatherstripping Set**

- TPR vinyl magnetic construction with 1/2" kerf insert
- Stays flexible to 0°F
- 5/8" flange height
- 1/4" flange thickness
- includes 36" strip for top of door, 82" strip for latch side of door and 82" strip for hinge side of door

Q #	price
G1668186	<b>\$16.88</b>



**TOLCO  
Multi-Purpose Door Stop**

- Thermoplastic elastomer
- Built-in magnet attaches to any metal surface
- 2 1/2" w x 4" l x 2 1/4" h

Q #	price
G4245306	<b>\$14.70</b>



**ROCKWOOD  
Circular Door Stops**

- Satin stainless steel with DuraFlex tip
- Screw-in wall mounting
- 2 1/2" base
- 3/4" projection
- includes hardware

Q #	item	price
G1694077	concave	
G0489002	convex	
each		<b>\$4.76</b>



**BATTALION  
Lever Door Holder**

- Brass with satin chrome finish
- Wall mount
- Rubber tip
- 4" projection
- includes hardware

Q #	price
G0958334	<b>\$36.40</b>



**LAMP  
Magnetic Door Holder**

- Plastic
- 26.4 lb max pull
- Wall/floor screw-in mounting
- 2 5/8" base, 3" x 1/4" strike
- includes hardware

Q #	price
G2315205	<b>\$11.69</b>



**BATTALION  
Rubber Door Wedge**

- Slides under doors to hold open
- 2 1/4" w x 6" l x 1 1/16" h

Q #	price
G1716522	<b>\$6.14</b>





# HINGES & HARDWARE

## VALUE BRAND Door Pull Handles

- Steel with polished zinc finish
  - 3/4" grip diameter
  - 1 1/2" projection
- includes hardware*



Z#	mounting hole center to center	grip length	includes screws	price
G1702041	4 7/8"	4"	#8 x 5/8"	<b>\$4.42</b>
G0287366	5 1/2"	4 1/2"	#9 x 3/4"	<b>\$5.35</b>

## SCHLAGE Entrance Knob Locksets

- Brass/steel/zinc knob
- Square corner, T-strike box
- C123 keyway — keyed different
- 1 1/8" x 2 3/4" strike, 2 3/8" backset
- ■ ANSI/BHMA STANDARDS



Z#	style	finish	price
G5045537	orbit	polished brass	<b>\$179.69</b>
G5045503	plymouth	satn chrome	<b>\$152.59</b>

## MASTER LOCK Classroom Door Lever Lockset

- Steel handle with satin chrome finish
- 6 pin cylinder
- Schlage keyway — keyed different (2 keys)
- 2 3/4" x 1 1/4" T-strike
- ■ ANSI/BHMA STANDARDS



Z#	price
G3364785	<b>\$42.82</b>

## YALE Rimlocks

- Steel with thumbturn design
  - KW1 keyway — keyed different
  - 5 pin single cylinder
  - Fits 1 3/8" to 2 1/4" thick doors with 2 3/8" backset
- includes (2) hardened steel inserts, 1109E brass cylinder and (2) keys*



Z#	type	finish	price
G2377715	jimmyproof deadlock	bronze	<b>\$49.89</b>
G2932176	heavy duty deadbolt	brass	<b>\$31.66</b>

## KABA ILCO Night Latch Auxiliary Lock

- Zinc chromated heavy gauge steel
- KW1 keyway — keyed different (2 keys)
- 5 pin single cylinder
- Fits 1 3/8" to 2 1/4" door thickness
- 2 1/2" backset



Z#	price
G2501247	<b>\$11.65</b>



## PEMCO Privacy Door Latches

- Aluminum
  - For use with metal or wood door frame
  - 1 1/2" w x 1 1/2" l x 2 3/4" h
  - ► MORE FINISHES AVAILABLE ONLINE
- includes hardware*

Z#	finish	price
G0776142	polished chrome	<b>\$21.31</b>
G1038037	satn chrome/nickel	
G0963365	satn brass	

## BATTALION Sliding Door Jamb Latch

- Steel with zinc finish
  - For use with 450 lb, 600 lb and 1,000 lb steel tracks
  - 1 3/16" w x 7" l x 2 7/8" h
- includes hardware*



Z#	price
G2358833	<b>\$22.00</b>

## BATTALION Spring Loaded Chain Bolt

- Steel with zinc finish
  - Surface and angle strike operation
  - 3/8" x 3" bolt
  - 1 1/2" w x 3" l x 1 1/16" h
- includes hardware and 24" chain*

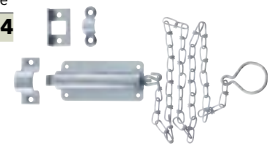

Z#	price
G0735095	<b>\$21.54</b>

## BATTALION Heavy Duty Barrel Bolts

- Zinc finish
  - Padlockable—surface strike only
  - 1 1/8" width
  - 2 1/2" height
- includes hardware*



Z#	length	throw	price
G1480543	4"	1"	<b>\$8.76</b>
G1901645	6"	1 1/4"	<b>\$11.11</b>

## MASTER LOCK Right Angle Padlock Eye

- Zinc plated steel
  - 1/2" shackle (max)
  - 1" w x 1 1/2" l x 1" h
  - 2 pack
- includes mounting hardware*



Z#	price
G1155971	<b>\$2.30</b>

## VALUE BRAND Fixed Staple Hasps

- Zinc plated steel
- 3/8" shackle (max)
- 1 1/2" width
- 7/8" height



Z#	length	price
G1526524	3 3/4"	<b>\$2.92</b>
G2705281	4 1/2"	<b>\$3.17</b>

## BATTALION Latching Post Safety Hasp

- Steel
  - 3/8" shackle (max)
  - 1 1/2" w x 3 3/8" l x 1 1/2" h
- includes mounting hardware*



Z#	price
G3227813	<b>\$12.22</b>

## MASTER LOCK Telescoping Sliding Door Lock

- Steel
  - 27 1/2" to 42" adjustable length
  - 1 1/16" width
  - 2 1/2" height
- includes hardware*



Z#	price
G3263224	<b>\$15.43</b>

## BATTALION Sliding Showcase Locks

- Steel with chrome finish
  - 1" projection
  - 3/16" x 5 1/2"
- includes tightening thumb screw*



Z#	type	price
G1142163	keyed alike	<b>\$17.56</b>
G2466107	keyed different	<b>\$19.07</b>

## PHOENIX T-Latch Lock

- Stainless steel
- Twist-to-unlatch closure
- Flush mount
- For use with right-hand mounting applications



Z#	price
G4232575	<b>\$17.87</b>

See more padlocks on page 32

**BATTALION**  
**Bottom Mount Drawer Slides**

- Zinc plated steel
- 4-way adjustment slots and lift-out disconnect
- Bottom-mount
- 1/2" width
- 2 pack
- Hardware NOT included

#	price
G1225673	<b>\$1.97</b>



**BATTALION**  
**Double Magnetic Catch**

- Steel
- Surface mount
- (2) 1 1/4" x 7/8" strike plates
- 1 3/8" x 3 1/4" catch
- includes hardware*

#	price
G3137933	<b>\$13.28</b>



**VALUE BRAND**  
**Ultra Thin Magnetic Catch**

- Steel
- Surface mount
- Single 1 3/8" x 3/4" strike plate
- 1 1/2" x 1 1/8" catch
- includes hardware*

#	price
G2324962	<b>\$5.27</b>



**LAMP**  
**Pull-to-Open Grab Catches**

- Plastic
- Spring closure
- Surface mount
- 2 3/8" x 2 5/8" catch
- Hardware NOT included

#	price
G2145595	<b>\$2.04</b>



**VALUE BRAND**  
**Chest Pull Handle**

- Steel with polished zinc finish
- 2" center to center mounting hole
- 1/4" grip diameter
- includes #6 x 3/4" screws for mounting*

#	price
G1176603	<b>\$4.63</b>



**VALUE BRAND**  
**Under Shelf Hooks**

- Steel with nickel finish
- 35 lb working load limit
- 3" w x 3 3/8" d x 2 1/2" h
- 2 pack
- includes screws*

#	price
G3052822	<b>\$14.08</b>



**JOHN STERLING**  
**Shelf Brackets**

- Heavy duty steel
- Hardware NOT included
- **MORE AVAILABLE ONLINE**

#	capacity	length	height	color	price
G0649783	125 lb	11 1/4"	7 3/4"	black	<b>\$1.78</b>
G3209552	500 lb	10 1/2"	7 1/2"	white	<b>\$5.50</b>

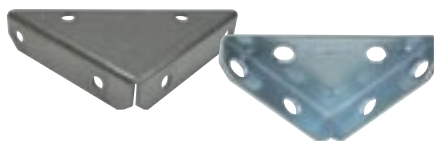

**VALUE BRAND**  
**Triangle Corner Braces**

- Heavy duty steel with zinc finish
- 2 holes per leaf

#	dimensions	price
G0303755	2" w x 2" d x 2" h	<b>\$2.15</b>
G1478215	4" w x 4" d x 4" h	<b>\$6.76</b>

**VALUE BRAND**  
**L-Shaped Corner Braces**

- Steel with zinc finish
- 4 counter sunk holes (2 on each side)
- includes hardware*

#	dimensions	price
G1551645	3/4" w x 2" l x 2" h	<b>\$0.87</b>
G2724303	3/4" w x 3" l x 3" h	<b>\$1.11</b>
G3323117	3/4" w x 4" l x 4" h	<b>\$2.25</b>



**BATTALION**  
**Vertical Blind Bracket**

- Steel
- 1 7/8" x 3"

#	price
G1289486	<b>\$4.70</b>



**BATTALION**  
**Valance Clip**

- For use with vertical blinds
- 3 1/2" x 3 3/4"
- 10 pack

#	price
G1757122	<b>\$8.93</b>



**BATTALION**  
**Vertical Blind Cord Weight**

- Attaches to cord to repair uneven or faulty blinds
- 1 1/8" x 4 5/16"

#	price
G3214382	<b>\$7.77</b>

**BATTALION**  
**Mini Blinds**

- 1" PVC slats
- Extruded PVC head and bottom rails
- 72" length

#	width	price
G1150134	22"	<b>\$20.13</b>
G0312426	30"	<b>\$25.07</b>



**JOHN STERLING**  
**Window Security Guard**

- Powder coated steel
- Adjustable to fit 24" to 42" windows
- 29 7/16" height
- 1" width

*includes locking channel and mounting screws*

#	price
G1360204	<b>\$58.40</b>

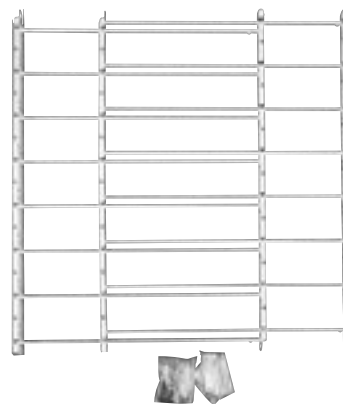



# RAW MATERIALS

MORE THAN 800,000 ITEMS ONLINE

## VALUE BRAND Aluminum Angle Stock

- 6061 alloy
- 90°
- 1/8" thickness

Item #	leg length	length	price
G2823712	1 1/2"	4'	<b>\$10.50</b>
G2593735	1 1/2"	8'	<b>\$20.25</b>
G3109732	2"	4'	<b>\$13.50</b>
G0882664	2"	8'	<b>\$27.00</b>

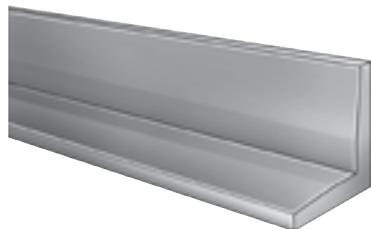

## VALUE BRAND Aluminum Flat Stock

- 6061 alloy

Item #	thickness	width	length	price
G0872925	3/8"	3"	3'	<b>\$8.61</b>
G1281192	3/8"	4"	3'	<b>\$11.70</b>
G0628993	3/4"	2"	6'	<b>\$22.91</b>
G1785901	1/2"	3"	3'	<b>\$31.59</b>
G2710355	1"	2"	1'	<b>\$14.64</b>
G2728625	1"	2"	3'	<b>\$42.12</b>

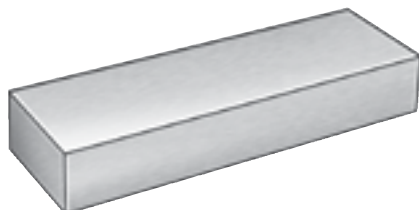

## VALUE BRAND Aluminum U-Channels

- 6063 alloy
- 8' length
- 0.125" thickness

Item #	leg length	base width	price
G4334163	1/2"	1"	<b>\$9.02</b>
G4334154	1/2"	1 1/2"	<b>\$10.54</b>
G4334145	1/2"	2"	<b>\$12.92</b>
G4334127	3/4"	3/4"	<b>\$12.57</b>
G4334066	1 1/2"	1 1/2"	<b>\$26.33</b>

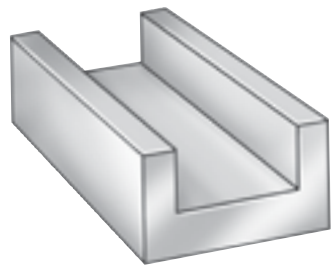

## VALUE BRAND Copper Flat Stock

- 110 alloy
- 1" width
- 6' length

Item #	thickness	price
G1881765*	3/16"	<b>\$67.11</b>
G0332105*	3/8"	<b>\$136.65</b>
G3074337*	5/8"	<b>\$229.05</b>

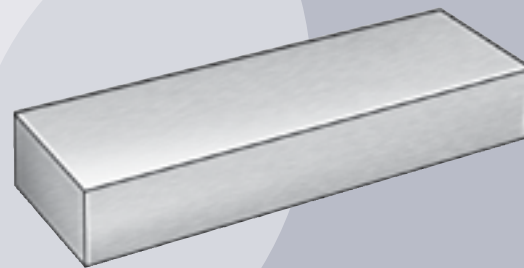

## VALUE BRAND Aluminum Rod Stock

- 6063 alloy
- 8' length

Item #	dia	price
G4333865	3/8"	<b>\$8.63</b>
G4333874	1/2"	<b>\$14.95</b>
G4333883	3/4"	<b>\$32.81</b>



## VALUE BRAND Copper Sheet Metal

Item #	thickness	width	length	price
G3123041	0.025"	4"	10"	<b>\$15.99</b>
G7491872	0.016"	12"	18"	<b>\$25.01</b>

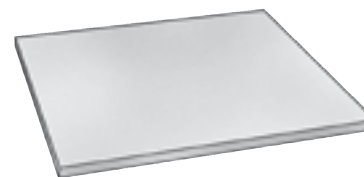

## VALUE BRAND Steel Rod Stock

- 4140 alloy
- 3' length

Item #	dia	price
G0525953	1/2"	<b>\$8.53</b>
G1689143	5/8"	<b>\$13.26</b>
G1145207	1 1/2"	<b>\$130.43</b>



## THOMSON Chrome Steel Ball Stock

- 52100 alloy
- Grade 25
- 100 pack

Item #	dia	weight	price
G0585304	1/4"	1.050 g	<b>\$10.72</b>
G2434065	5/32"	1.497 g	<b>\$8.79</b>
G0872085	3/16"	2.052 g	<b>\$12.19</b>



## VALUE BRAND Perforated Steel Sheets

- 1008 alloy
- 22 gauge
- 40" x 36"

Item #	hole pattern	price
G2024346	<i>staggered round</i>	<b>\$26.59</b>
G1847921	<i>staggered hexagon</i>	<b>\$26.49</b>

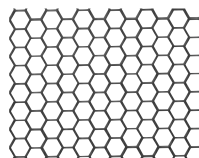
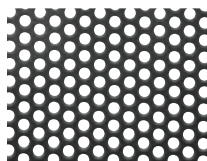

## VALUE BRAND Type 304 Stainless Steel Square Tube Stock

- 6' length

Item #	inside square	outside square	price
G1195031	2 7/32"	1"	<b>\$32.49</b>
G1310197	1 1/8"	1 1/2"	<b>\$31.86</b>
G3507515	1 7/32"	2"	<b>\$51.66</b>



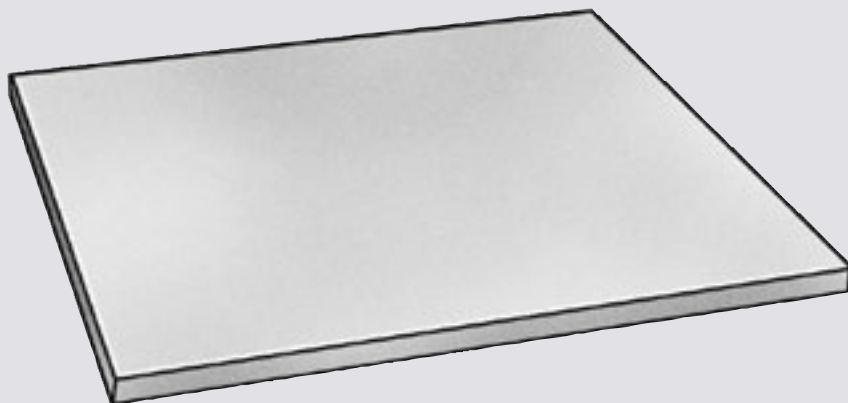

**VALUE BRAND  
ABS Sheet Stock**

- Black
- 48" length

Z#	thickness	width	price
G2809527	0.063"	24"	<b>\$13.22</b>
G2764255	0.125"	12"	<b>\$11.56</b>
G1148655	0.250"	24"	<b>\$40.09</b>

**VALUE BRAND  
PVC Sheet Stock**

- Type 1
- Dark gray
- 0.25" thickness

Z#	width	length	price
G0422965	12"	12"	<b>\$6.12</b>
G2346373	12"	24"	<b>\$12.23</b>
G2254813	24"	24"	<b>\$21.71</b>
G2309806	24"	48"	<b>\$43.43</b>

**VALUE BRAND  
PETG Sheet Stock**

- Clear
- 0.063" thickness

Z#	width	length	price
G0837812	12"	12"	<b>\$2.12</b>
G1361866	12"	24"	<b>\$4.10</b>
G2421097	24"	24"	<b>\$9.78</b>
G0374385	24"	48"	<b>\$12.97</b>

**TIVAR  
UHMW-PE Sheet Stock**

- Black

Z#	thickness	width	length	price
G2293347	0.25"	12"	24"	<b>\$13.88</b>
G0637113	0.25"	12"	48"	<b>\$27.35</b>
G3159676	0.25"	24"	24"	<b>\$26.05</b>
G3240045	0.5"	12"	12"	<b>\$13.32</b>
G2835996	0.5"	12"	24"	<b>\$25.92</b>
G1198233	0.5"	24"	48"	<b>\$101.16</b>

**LEXAN  
Polycarbonate Sheet Stock**

- Clear

Z#	thickness	width	length	price
G1651675	0.060"	24"	24"	<b>\$11.07</b>
G1975041	0.093"	24"	24"	<b>\$16.51</b>
G3211293	0.093"	24"	48"	<b>\$28.29</b>
G0641252	0.093"	48"	48"	<b>\$65.39</b>
G3382495	0.220"	24"	48"	<b>\$57.89</b>
G1942507	0.220"	48"	48"	<b>\$121.47</b>
G2053861	0.236"	48"	48"	<b>\$151.22</b>
G2042932	0.236"	48"	96"	<b>\$280.74</b>
G0556491	0.375"	24"	24"	<b>\$59.63</b>
G2599983	0.5"	24"	48"	<b>\$156.65</b>

**VALUE BRAND  
HDPE Sheet Stock**

**Black**

Z#	thickness	width	length	price
G1566214	0.25"	12"	12"	<b>\$4.22</b>
G2914947	0.25"	12"	24"	<b>\$7.22</b>
G1469422	0.25"	24"	48"	<b>\$28.86</b>
G2629261	0.375"	12"	24"	<b>\$10.76</b>
G0496991	0.5"	12"	12"	<b>\$8.40</b>
G0402062	0.5"	12"	24"	<b>\$14.35</b>

**Off-White**

- 24" width
- 48" length

Z#	thickness	price
G2973135	0.25"	<b>\$26.04</b>
G1481715	0.5"	<b>\$52.01</b>

**VALUE BRAND  
Acrylic Sheet Stock**

- Extruded
- 24" width
- 48" length

Z#	color	thickness	price
G0606742	clear	0.093"	<b>\$23.97</b>
G0695362	black	0.118"	<b>\$34.86</b>

**DELTRIN  
Acetal Homopolymer Rod Stock**

- White

Z#	dia	length	price
G1613272	3/4"	1'	<b>\$0.49</b>
G2986374	1/2"	1'	<b>\$1.19</b>
G0723782	3/4"	1'	<b>\$2.29</b>
G3163115	1"	1'	<b>\$4.42</b>
G2344273	3/8"	3'	<b>\$2.09</b>
G1000151	1/2"	3'	<b>\$3.29</b>
G2899574	3/4"	3'	<b>\$6.39</b>
G2907931	1"	3'	<b>\$11.59</b>



**VALUE BRAND  
Nylon 6/6 Rod Stock**

- Black

Z#	dia	length	price
G3339043	3/4"	1'	<b>\$0.49</b>
G2866227	1/2"	1'	<b>\$1.09</b>
G3479813	3/4"	1'	<b>\$2.43</b>
G3404773	1"	1'	<b>\$3.94</b>
G1382437	1/4"	3'	<b>\$1.32</b>
G3317447	1/2"	3'	<b>\$3.01</b>
G2683283	3/4"	3'	<b>\$6.62</b>
G1408145	1"	3'	<b>\$11.00</b>

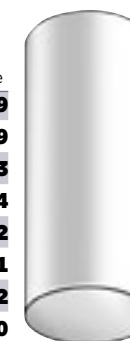

**DYNAFORM  
ISO Rod Stock**

- Natural color

Z#	dia	length	price
G2993532	3/4"	5'	<b>\$2.59</b>
G2495464	3/8"	5'	<b>\$3.63</b>
G0836945	1/2"	5'	<b>\$7.20</b>
G1662245	3/4"	5'	<b>\$16.76</b>
G1583382	3/4"	10'	<b>\$4.92</b>
G0497926	3/8"	10'	<b>\$8.39</b>
G1160704	1/2"	10'	<b>\$13.11</b>
G0515225	3/4"	10'	<b>\$30.42</b>



**VALUE BRAND  
UHMW-PE Tube Stock**

- White
- 3' length

Z#	ID	OD	thickness	price
G0987594	3/4"	7/8"	0.312"	<b>\$24.06</b>
G3146166	3/8"	3/4"	0.375"	<b>\$21.47</b>
G1116306	1/2"	1"	0.25"	<b>\$20.92</b>
G1192536	3/4"	1"	0.125"	<b>\$20.92</b>



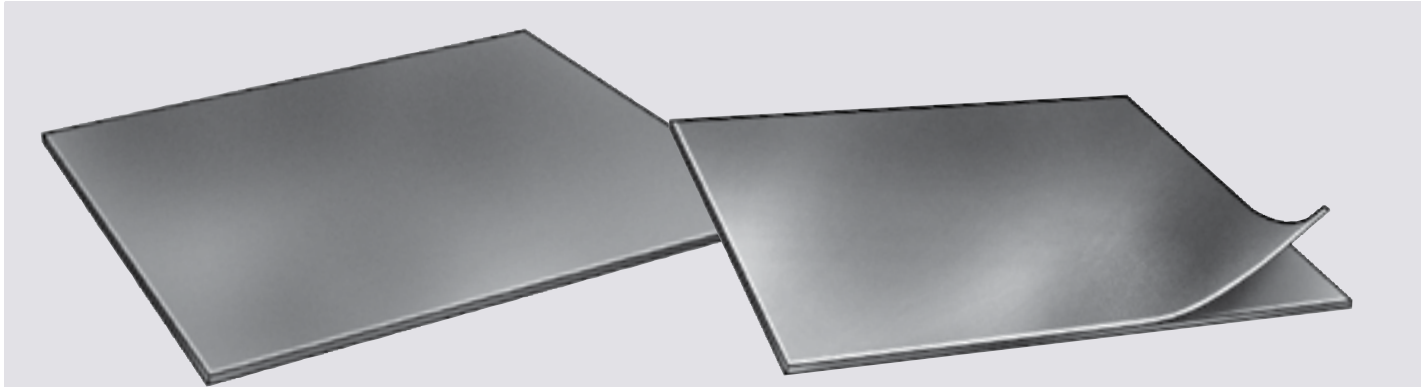

**VALUE BRAND  
Viton Rubber Sheets**

- Black
- 1/2" thickness
- 12" width
- 70 A durometer

Z#	length	price
G2143994	12"	<b>\$189.99</b>
G2827483	24"	<b>\$389.99</b>

**VALUE BRAND  
Natural Gum Rubber Strips**

- Tan
- 1/8" thickness
- 36" length
- 40 A durometer

Z#	width	price
G1251056	2"	<b>\$4.19</b>
G0440334	4"	<b>\$6.99</b>
G1569452	6"	<b>\$10.29</b>

**VALUE BRAND  
Buna-N/Nitrile Rubber Sheets**

- Black
- 3/32" thickness
- 50 A durometer

Z#	width	length	price
G1275933	12"	12"	<b>\$4.39</b>
G3258744	12"	24"	<b>\$9.00</b>
G3287812	36"	36"	<b>\$89.97</b>

**VALUE BRAND  
EPDM Rubber Sheets**

- Black
- 1/32" thickness
- 60 A durometer
- 12" width

**Plain Backing**

Z#	length	price
G2454146	12"	<b>\$1.99</b>
G2774667	24"	<b>\$3.89</b>
G1880182	36"	<b>\$7.49</b>

**Adhesive Backing**

Z#	length	price
G6540362*	24"	<b>\$18.75</b>
G7118964*	36"	<b>\$26.27</b>

**VALUE BRAND  
SBR Rubber Strips**

- Black
- 1/8" thickness
- 36" length
- 70 A durometer

Z#	width	price
G1041582	2"	<b>\$2.39</b>
G0782074	4"	<b>\$4.69</b>
G3492903	6"	<b>\$7.19</b>

**VALUE BRAND  
Neoprene Rubber Sheets**

- Black
- 12" width
- 30 A durometer

Z#	thickness	length	price
G1086522	1/8"	12"	<b>\$3.79</b>
G1076047	1/8"	36"	<b>\$19.99</b>
G0627891	1/4"	12"	<b>\$7.59</b>
G1094396	1/4"	36"	<b>\$38.51</b>

**VALUE BRAND  
Silicone Rubber Sheets**

- Red
- 12" width
- 40 A durometer

**Plain Backing**

Z#	thickness	length	price
G1989276	1/32"	12"	<b>\$4.19</b>
G0599286	1/32"	24"	<b>\$8.29</b>
G3310203	1/4"	12"	<b>\$35.99</b>
G0488661	1/4"	24"	<b>\$71.97</b>

**Adhesive Backing**

Z#	thickness	length	price
G6260274*	1/32"	24"	<b>\$25.45</b>
G6260152*	1/4"	12"	<b>\$44.85</b>
G6260466*	1/4"	24"	<b>\$73.82</b>

**VALUE BRAND  
Buna-N/Nitrile Rubber Rolls**

- Black
- 3/8" thickness
- 36" width
- 16' length
- 40 A durometer

Z#	price
G7241412*	<b>\$644.28</b>

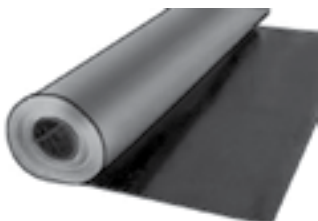

**VALUE BRAND  
SBR/Gum Rubber Rolls**

- Black
- 1/4" thickness
- 12" width
- 60 durometer

Z#	length	price
G4374903	10'	<b>\$96.99</b>
G4374912	25'	<b>\$241.99</b>
G4374921	50'	<b>\$499.99</b>



**VALUE BRAND  
Buna-N Rubber Cord**

- Black
- 10' length
- 70 durometer

Z#	dia	price
G4336421	1/4"	<b>\$3.39</b>
G4336446	3/16"	<b>\$4.09</b>
G4336455	3/8"	<b>\$5.19</b>



**VALUE BRAND**  
220 Polyethylene Foam Sheets

- Closed cell
- Charcoal
- 24" width

Q#	thickness	length	price
G1612895	¼"	18"	<b>\$4.79</b>
G2030655	¼"	54"	<b>\$8.55</b>
G0683681	½"	18"	<b>\$8.46</b>
G1880961	½"	54"	<b>\$14.57</b>
G1585263	¾"	54"	<b>\$23.06</b>
G2040297	1"	18"	<b>\$13.84</b>
G3186811	1"	54"	<b>\$30.76</b>
G2852001	2"	18"	<b>\$27.92</b>

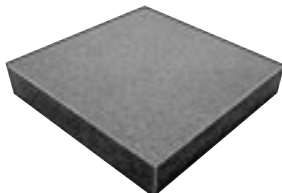

**VALUE BRAND**  
Polyethylene Vinyl Foam Sheets

- Closed cell
- Charcoal
- 12" width
- 12" length

Q#	thickness	price
G3031323	½"	<b>\$3.97</b>
G1642733	¾"	<b>\$5.93</b>
G0451945	1"	<b>\$7.37</b>

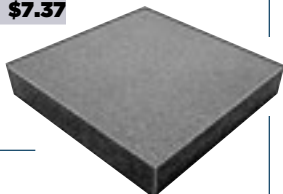

**VALUE BRAND**  
Cork Sheet Stock

- CR117
- 36" width
- 24" length

Q#	thickness	price
G3365941	.8mm	<b>\$1.38</b>
G3176275	1.5mm	<b>\$2.58</b>
G0261021	3mm	<b>\$5.14</b>

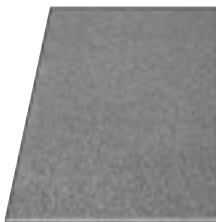

**NEW YORK WIRE**  
Wire Cloth

- 18x16 mesh
- .011" wire diameter
- 36" width
- 100' length

Q#	material	price
G4990535	aluminum	<b>\$67.89</b>
G4724666	fiberglass	<b>\$42.11</b>



**VALUE BRAND**  
Felt Strips

- Gray wool
- 120" length

**Plain Backing**

Q#	thickness	width	price
G1004954	¼"	1"	<b>\$8.74</b>
G0458561	½"	1½"	<b>\$14.92</b>

**Adhesive Backing**

Q#	thickness	width	price
G1838024	¼"	1"	<b>\$8.23</b>
G0322332	½"	1½"	<b>\$44.44</b>



**THOMSON**  
Silicon Nitride Ceramic Balls

Q#	dia	weight	pack	price
G1374922	⅜"	0.183 g	25	<b>\$42.47</b>
G2041864	¼"	0.704g	10	<b>\$31.87</b>
G1608731	⅝"	2.376g	10	<b>\$53.65</b>



**TRIM LOK INC**  
Vinyl Edge Trim

- Dual grip
- 25' length

Q#	fits	leg length	overall width	price
G4338275	.125" edge	.4375"	.295"	<b>\$19.99</b>
G4338047	.125" edge	.5625"	.295"	<b>\$18.99</b>
G4064541	.1875" edge	.5312"	.3575"	<b>\$18.99</b>
G4338056	.25" edge	.5"	.42"	<b>\$18.99</b>



**TRIM LOK INC**  
Window Locking Gaskets

- EPDM rubber
- 25' length
- Fits .1875 - .25" glass

**One Piece**

Q#	fits	price
G4338241	.09-.14" edge	<b>\$34.39</b>
G4112683	.1875-.25" edge	<b>\$47.62</b>

**Two Piece**

Q#	fits	price
G4338232	.093-.14" edge	<b>\$31.99</b>

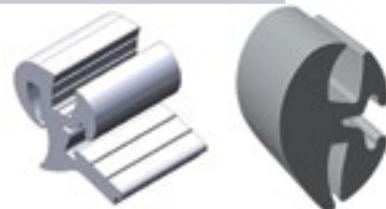

**TRIM LOK INC**  
Rubber Seals

- D-shape
- Adhesive backing

Q#	height	width	length	price
G4004454	.375"	.625"	100'	<b>\$49.71</b>
G4163661	.563"	.75"	25'	<b>\$18.73</b>
G4109472	.563"	.75"	250'	<b>\$148.19</b>

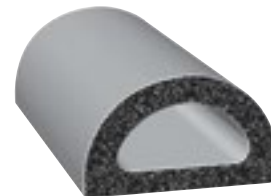

**VALUE BRAND**  
SBR Rubber Grommets

- Black

Q#	ID	OD	overall thickness	panel thickness	pack	price
G1607286	⅝"	¾"	¼"	⅜"	50	<b>\$2.36</b>
G1206292	¾"	1⅜"	⅝"	⅜"	50	<b>\$6.70</b>
G1000702	¾"	1½"	⅝"	⅜"	25	<b>\$6.43</b>
G1199694	1¼"	1⅞"	⅝"	⅜"	25	<b>\$8.94</b>



**VALUE BRAND**  
Silicone Rubber Grommets

- Red

Q#	ID	OD	overall thickness	panel thickness	pack	price
G0622282	¼"	⅝"	⅜"	⅜"	10	<b>\$4.20</b>
G0627532	⅜"	⅞"	¼"	⅜"	25	<b>\$4.55</b>
G1209476	⅝"	⅞"	⅜"	⅜"	5	<b>\$5.75</b>
G0813251	⅝"	⅞"	⅜"	⅜"	5	<b>\$5.53</b>
G3104087	½"	1⅜"	⅝"	⅜"	5	<b>\$6.39</b>





# TAPES & ADHESIVES, SHIPPING & OFFICE SUPPLIES



## TOP BRANDS



### ADHESIVES

pg 274



### TAPES

pg 277

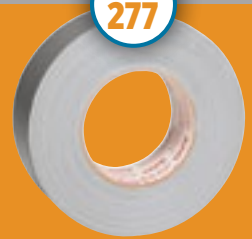

### PROTECTIVE PACKAGING

pg 278



### CARTONS

pg 279



### DESK SUPPLIES

pg 282



### BREAKROOM SUPPLIES

pg 284



### COOKWARE

pg 285



### SHOP FURNITURE

pg 289



### OFFICE FURNITURE

pg 290



### DÉCOR

pg 291





**STANLEY Mini Glue Gun**

- 15 W, 120 V hot melt gun
- Trigger feed
- 385°
- F operating temp
- ¼" glue stick capacity

includes fold-out stand

#	price
G2138577	<b>\$3.17</b>



**ARROW Professional Glue Gun**

- Non-drip nozzle with heavy duty circuitry
- 40 W, 120 V
- 3 finger lever feed
- 380°F operating temp
- ½" glue stick capacity

#	price
G1667872	<b>\$16.44</b>



**WESTWARD Hot Melt Glue Sticks**

- Opaque, non-toxic glue with flexible joint and superior heat resistance
- ⅞" diameter, 10" length
- For use with ⅞" and ½" capacity glue gun
- 0° to 380°F operating temp
- 30-60 sec application time
- 12 pack

#	price
G4952841	<b>\$5.54</b>

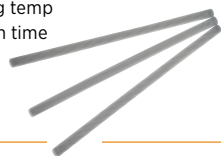

**J-B WELD Cold-Weld Epoxy Adhesives**

- Waterproof
- Temperature resistant, non-toxic formula
- Heavy duty bonding in automotive, home, industrial, farm, and marine applications
- 4-6 hr application time
- 24 hr full cure
- 1 to 2 hr work life
- 3960 psi shear strength
- 1:1 mixing ratio
- Gray

#	includes	price
G0364253	(2) 1 oz tubes	<b>\$3.14</b>
G1676105	(2) 5 oz tubes	<b>\$9.12</b>



**SCOTCH-WELD Epoxy Adhesive**

- High shear and peel adhesive
- 2:1 mixing ratio
- Bonds to metals, plastics, rubber (except EPDM), glass, ceramics, and paper
- 4500 psi shear strength
- -67° to 250°F temperature range
- 20 min work life
- 4 day full cure
- 37 mL duo-pak cartridge

#	price
G2499411	<b>\$19.50</b>



**3M Polygun Electronic Control Applicator**

- For use with "Q" and "LMQ" adhesives
- Delivers up to 5.5 lb of jet-melt adhesive per hour
- ⅝" x 8" glue stick capacity
- 350 W, 120 V
- 260° to 450°F operating temp

#	price
G0943932	<b>\$423.13</b>



**3M LMQ Hot Melt Adhesives**

- High performance adhesive that bonds to variety of materials
- Provides fast strong bonds that remain flexible
- ⅝" diameter, 8" length
- For use with EC applicator
- 165 pack

#	color	operating temperature	shear strength	price
G1717581	amber	0° to 130°F	480 psi	<b>\$137.65</b>
G2812643	clear	0° to 140°F	350 psi	<b>\$176.39</b>



**DEVCON 2-Ton Epoxy Cartridges**

- Water-resistant, non-shrinking formula
- 1:1 mixing ratio
- -40° to 200°F temperature range
- 16 hr full cure
- 12 min work life
- 2250 psi shear strength

#	size	price
G0586582	25 mL dev-tube	<b>\$5.66</b>
G1737111	50 mL dev-pak	<b>\$11.34</b>



**3M EPX Applicator and Nozzle**

- EPX Plus II Applicator**
- 1:1 and 2:1 ratio plunger
  - Use with 50 mL duo-pak cartridges
- includes (2) plungers

#	price
G1111686	<b>\$64.07</b>



- EPX Mixing Nozzle**
- Stepped tip
  - Nozzle for 10:1 ratio products
  - Use with G1111686
  - 12 pack

#	price
G3420803	<b>\$25.72</b>



**3M Scotch-Weld DP100+**

- High shear, fast curing epoxy
- 1:1 mixing ratio
- -60° to 300°F temperature range
- 3500 psi shear strength
- 4 min application time
- 48 hr full cure
- 4 min work time
- 50 mL duo-pak cartridge
- Clear

#	price
G1011683	<b>\$17.21</b>



**GORILLA GLUE Multipurpose Epoxy Adhesive**

- Clear formula
- Low set time
- 1:1 ratio
- Temperature range of -10° to 200°F
- 2600 psi shear strength
- 0.85 fl-oz syringe

#	price
G2756607	<b>\$3.91</b>



**HARDMAN One-Time Use Epoxy Adhesive**

- Light amber, fast setting formula
- 1:1 mixing ratio
- Up to 180°F temperature range
- 15 to 30 min functional cure
- 3 to 5 min work life
- 3.5 g packets
- 10 pack
- Bonds to wood, glass, metal, stone, concrete, ceramics and leather

#	price
G4117285	<b>\$15.02</b>





# TAPES & ADHESIVES

## GORILLA GLUE All-Purpose Glue

- Extremely strong bonding power to wood, stone, metal, ceramic, etc
- Waterproof
- Brown
- 10 to 15 min application time
- 1 to 2 hr clamp time
- 24 hr full cure



Item #	size	price
G0912441	4oz	<b>\$8.22</b>
G2617711	8oz	<b>\$14.32</b>
G0329585	18oz	<b>\$18.82</b>
G2389441	36oz	<b>\$31.30</b>

## GORILLA GLUE Instant Bonding Super Glue

- Clear rubber toughened polyurethane adhesive
- Anti-clog tip
- 10 to 30 second clamp time
- 24 hr full cure
- 15 g bottle



Item #	price
G2780355	<b>\$3.42</b>

## GORILLA GLUE Wood Glue

- Indoor and outdoor use for hardwoods, softwoods, and composites
- Cream color that dries to natural color
- Water-resistant, non-toxic
- 5 to 10 min application time
- 20 to 30 min clamp time
- 24 hr full cure
- 18 oz bottle



Item #	price
G1050917	<b>\$4.14</b>

## LOCTITE Super Bonder 495 Instant Adhesive

- Clear cyanoacrylate formula
- Designed to bond to rubber, metal, and plastic parts with gaps up to 0.004"
- 20 second application time
- 24 hr full cure
- 20g/L VOC content



Item #	size	price
G1859681	3g tube	<b>\$2.85</b>
G2792343	1oz bottle	<b>\$14.37</b>

## 3M Fastbond Contact Adhesive

- Non-flammable, water-based formula
- Bonds to foamed plastics, plastic laminate, wood, plywood, wood veneer, and canvas to themselves or each other
- Color changes from blue to green when dry
- 1 qt bottle
- **VOC LEVELS MEET SCAQMD REQUIREMENTS**
- **GREENGUARD CERTIFIED**



Item #	price
G1144376	<b>\$30.60</b>

## GLUE DOTS Adhesive Bonding Dots

- Fast bonding self adhesive
- Clear medium track dots
- For binding, fulfillment, packaging, signage, direct mail, and product assembly applications
- 1/2" round
- 1/8" thick, low profile
- 4,000 pack



Item #	price
G4360815	<b>\$58.88</b>

## 3M Spray Adhesives

- **VOC LEVELS MEET SCAQMD REQUIREMENTS**

### Super 77

- Multi-purpose applications
- High coverage
- 15 to 30min application time
- Transparent and fast drying
- 16.75 oz net
- **MMM-A-1055B STANDARDS**



Item #	price
G0841057	<b>\$14.04</b>

### FoamFast 74

- Fast track, foam tearing strength
- Soft, non dimpling glue line precision spray control with variable spray pattern
- 15min application time
- 17.25oz net



Item #	price
G3218871	<b>\$16.23</b>

## SUPER GLUE Instant Adhesives

- Cyanoacrylate formula
- 2 g tube
- 10 to 30 second application time
- 24 hr full cure
- 209K VOC content
- 12 pack

### Liquid

- Forms a strong bond in tight joints between clean breaks or smooth surfaces
- Best used with non-porous application parts, adheres to aluminum, ceramic, china, metal, most plastics, pottery, rubber, and wood
- .004" gap fill

Item #	price
G2688086	<b>\$5.10</b>



### Gel

- Best used for clean, vertical, and porous surfaces
- Adheres to aluminum, ceramic, china, wood, leather, rubber, and vinyl
- .020" gap fill

Item #	price
G2177481	<b>\$4.73</b>



## LOCTITE Threadlocker 242

- Medium strength anaerobic formula designed to apply to threaded components
- 1/4" to 3/4" locking nuts and bolts
- Removable with hand tools
- 5 min application time
- 0.005" gap fill
- 24 hr full cure
- Blue
- **ASTM, NSF, CFIA, OSHA, AND HAZARD COMMUNICATION STANDARDS. ROHS COMPLIANT**



Item #	size	price
G3418737	10mL	<b>\$10.19</b>
G3027315	50mL	<b>\$28.33</b>

## DAP Kwik Foam

- Polyurethane insulating formula
- Indoor/outdoor use
- Expands to fill and seal large cavities for sealing around pipes, ducts, vents, electrical outlets and cables
- R-4 insulation value
- 2-3:1 expansion ratio
- Tan
- **UL CLASSIFIED, VOC LEVELS MEET SCAQMD REQUIREMENTS**



Item #	net size	price
G1826867	12 oz	<b>\$4.75</b>
G0324956	24 oz	<b>\$10.79</b>

## 3M Adhesive Remover

- Citrus-based remover
- Solvent free
- Can replace mineral spirits, acetone, and other organic solvents for general cleaning
- 18 1/2 oz net
- **GRAS (GENERALLY REGARDED AS SAFE), FOOD CONTACT APPLICATIONS UNDER FDA 21 CFR 182.20**



Item #	price
G1202047	<b>\$20.76</b>

## ELMER'S Multi-Purpose Glue

- Washable
- White glue that dries clear
- 60° to 75°F temp range



### Glue Stick

- Extra strength formula
- 30 to 60 second application time
- 0.88 oz
- 12 pack

Item #	price
G5701473*	<b>\$20.45</b>

### Liquid Glue

- Multi purpose
- Bonds cardboard, paper, cloth, leather and wood
- 1 to 2 min application time
- 1 gal



Item #	price
G5629522*	<b>\$22.73</b>

### DAP Painters Caulk

- Long lasting formula that is easily paintable
- For interior and exterior use
- 10 min application time
- 10.1 oz cartridge
- ■ ASTM STANDARDS

#	base	price
G1557893	acrylic latex formula	\$1.46
G0014874	acrylic latex, silicone formula	\$1.86



### NEWBORN Caulk Gun

- Industrial super ratchet rod caulk gun
- Zinc-chromate plated
- For use with 10.3 cartridges
- includes puncture tool

#	price
G1214884	\$11.01



### GE Contractor's SCS100 Silicone Sealant

- For indoor or outdoor use
- UV and weather resistant
- Adheres without primer to glass, metal, wood, and many plastics
- 30 min application time
- 24 hr to 48 hr full cure
- 10.1 oz cartridge
- ■ ASTM AND FEDERAL STANDARDS

#	price
G0003771	\$4.95



### MOMENTIVE RTV100 Series Industrial Silicone Sealant

- Highly-flexible gasket sealant
- Acetox cure
- Excellent fluid and high-temperature resistance
- For rigid or flexible flanges
- 10 min application time
- 24 hr cure
- 10.1 oz cartridge

#	price
G2066102	\$9.23



### PRO-SEAL RTV Silicone

- Low-solvent formula and sensor safe
- Best for high temperature applications
- Replaces gaskets, seals and dressings
- For rigid or flexible flanges
- 24 hr full cure
- includes nozzle

#	size	price
G2726263	3oz tube	\$1.76
G1444983	11.1 oz cartridge	\$7.14

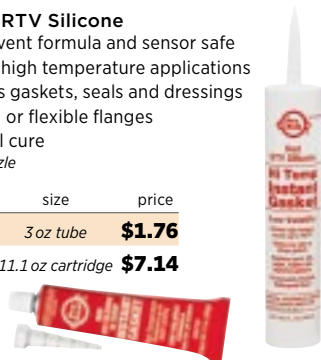

### DAP Silicone Rubber Sealant

- For indoor/outdoor use and provides watertight and flexible seal
- Adheres to glass, ceramic, fiberglass, wood, brick, metal, drywall, tile, concrete, canvas, porcelain, plastics, rubbers, painted surface, non-oily wood
- 20 min application
- 24 hr full cure
- 10.1 oz cartridge
- ■ ASTM STANDARDS

#	color	price
G0015032	clear	
G0015023	black	
G0015041	white	
G0015005	aluminum gray	
G0015014	almond	
G0015057	bronze	

each \$4.29



### GE Silicone I Window and Door Sealant

- Remains permanently flexible
- Waterproof, shrink-proof, and crack-proof
- Adheres to wood, metal, tile, glass, ceramic, drywall, and plaster
- 30 min application time
- 10.1 oz cartridge
- ■ ASTM STANDARDS
- ✓ PRODUCT CONTRIBUTES TO REDUCING ENERGY CONSUMPTION

#	color	price
G0003455	clear	\$4.05
G0003464	white	\$3.76



### GE Silicone II Window and Door Sealant

- Clear waterproof sealant with BioSeal
- Will not shrink or crack, permanently flexible
- Mold free and mildew resistant
- Adheres to most wood, metal, vinyl, siding, masonry, brick, concrete, drywall/plaster, glass, and plastic
- 10.1 oz cartridge
- ■ ASTM STANDARDS
- ✓ PRODUCT CONTRIBUTES TO REDUCING ENERGY CONSUMPTION

#	price
G0003482	\$5.57



### LOCTITE Sealants

- Methacrylate Ester formula
- 10,000 psi gas pressure range
- 50 mL tube
- White

### General Purpose 565 Pipe Sealant

- Seals pipes and tapered threads
- -65 to 300°F temperature range
- ■ AGA, UL, AND NSF STANDARDS

#	price
G3401763	\$12.88



### High Temperature 567 Thread Sealant

- Instantly seals all sizes of metal threaded pipes
- Protects against chemicals
- -65 to 400°F temperature range
- ■ NSF AND ANSI STANDARDS

#	price
G0925041	\$13.92



### HANDI-FOAM

#### Spray Foam Sealant Kit

- Indoor and outdoor use
- 2 components
- R-6 insulation value
- 4:1 expansion ratio
- 30 to 60 second application time
- 1 hr full cure
- 1.76 lb aerosol can
- ■ ASTM STANDARDS

#	price
G1589524	\$38.46



### DEVCON Repair Putty Kits

- 16 hr functional cure
- 1 lb cans
- includes resin and hardener

#### Plastic Steel

- Cures to form a tough durable metallic mass at room temperature
- Can be drilled, tapped, machined, or painted
- 2800 psi shear strength
- 250°F max temperature
- Dark grey

#	price
G2114576	\$36.92



#### Stainless Steel

- Non-rusting compound
- Bonds to ferrous and non-ferrous materials
- Acceptable for meat and poultry plants
- 2385 psi shear strength
- 250°F max temperature
- Grey

#	price
G2412584	\$69.18



#### Titanium

- Titanium reinforced epoxy is resistant to chemicals
- Resistant to high temperatures
- 350°F max temperature
- 2000 psi shear strength
- Grey
- ■ OSHA STANDARDS

#	price
G1887864	\$92.64



#### Aluminum

- Aluminum filled, non slumping
- Rust resistant
- 2600 psi shear strength
- 250°F max temperature

#	price
G2661242	\$51.53



### HERCULES Pro Poxy 20

- Dark gray/black fast acting epoxy putty can be drilled, filed, sanded, painted, and machined
- 700 psi shear strength
- 300°F max temperature
- 4 oz tube
- ■ NSF STANDARDS
- includes protective cap ends and reusable tube for storage

#	price
G2974377	\$6.42





# TAPES & ADHESIVES

MORE THAN 800,000 ITEMS ONLINE

## SCOTCH

### 35 Electrical Tape

- Color coding vinyl
- 220°F max, 600V max
- 7 mil thickness
- ¾" x 66' roll
- ■ UL, CSA, ROHS, ASTM STANDARDS

Item #	color
G0154472	red
G0154515	orange
G0154506	yellow
G0154497	green
G0154481	blue
G0154524	violet
G1111047	brown
G0154463	white

each **\$4.34**



## SCOTCH

### Super 33+ Electrical Tape

- Flame retardant vinyl
- 220°F max, 600V max
- 7 mil thickness
- ■ UL, CSA, ROHS, ASTM STANDARDS

Item #	roll	pack	price
G2444477	¾" x 66'	1	<b>\$4.20</b>
G1286065	¾" x 20'	10	<b>\$18.99</b>



## SCOTCH

### 130C Linerless Rubber Splicing Tape

- 266°F max, 69kV max
- 30 mil thickness
- ■ ASTM STANDARDS

Item #	roll	price
G3202805	¾" x 30'	<b>\$11.99</b>
G1588763	1" x 30'	<b>\$16.77</b>



## 3M

### Scotch 23 Rubber Splicing Tape

- Polyester lining
- 194°F max, 69kV max
- 30 mil thickness
- ¾" x 30' roll
- ■ ASTM STANDARDS

Item #	price
G2330912	<b>\$12.19</b>



## SCOTCH

### Super 88 Electrical Tape

- Heavy duty flame retardant vinyl
- 220°F max, 600V max
- 8.5 mil thickness
- ¾" x 66' roll
- ■ UL, CSA, ROHS, ASTM STANDARDS

Item #	price
G3280383	<b>\$5.06</b>



## 3M

### Scotch 2228 Rubber Mastic Tape

- 194°F max, 35kV max
- 65 mil thickness
- 1" x 10' roll
- ■ ASTM STANDARDS

Item #	price
G0308646	<b>\$11.75</b>



## 3M

### Scotch 2520 Varnished Cambric Tape

- Woven cotton cambric fabric
- 220°F max, 69kV max
- 8 mil thickness
- ¾" x 108' roll
- ■ ASTM STANDARDS

Item #	price
G0478581	<b>\$33.27</b>



## SCOTCH

### 27 Glass Cloth Electrical Tape

- Thermosetting rubber resin adhesive
- 266°F max, 600V max
- 7 mil thickness
- ■ UL, CSA, MIL, ASTM STANDARDS

Item #	roll	price
G0659443	½" x 66'	<b>\$8.81</b>
G1352425	¾" x 66'	<b>\$11.92</b>



## SCOTCH

### 69 Glass Cloth Electrical Tape

- Silicone adhesive
- 392°F max, 600V max
- 7 mil thickness
- ¾" x 66' roll
- ■ UL, CSA, MIL, ASTM STANDARDS

Item #	price
G1446453	<b>\$17.29</b>



## ER TAPE

### Self-Fusing Tape

- Silicone rubber
- 400V max
- 392°F max for continuous use
- 500°F max for intermittent use
- 20 mil thickness
- 1" x 36' roll

Item #	price
G2070634	<b>\$11.07</b>



276

**FREE** UPS Ground shipping on orders of \$50 or more\*

\$ prices subject to change

**GORILLA TAPE**  
**Black Duct Tape**

- Double-thick adhesive grips most surfaces
- Reinforced backing
- 17 mil thickness
- ■ UL STANDARDS

Q#	roll	price
G4393593	1" x 30'	<b>\$3.60</b>
G1866322	1.88" x 36'	<b>\$5.50</b>
G2523333	1.88" x 105'	<b>\$9.89</b>
G0329777	2.88" x 90'	<b>\$12.67</b>



**NASHUA**  
**Silver Duct Tape**

- Polyethylene coated cloth
- 48mm x 55m roll
- ■ UL STANDARDS

Q#	thickness	price
G2634432	9 mil	<b>\$3.96</b>
G1970604	10 mil	<b>\$6.05</b>



**TAPECASE**  
**Painters' Masking Tape**

- Fine blue crepe paper
- Synthetic rubber adhesive
- 5.5 mil thickness
- ■ PSTC, ASTM STANDARDS

Q#	roll	price
G3902254	¾" x 180'	<b>\$2.30</b>
G4242201	¾" x 180'	<b>\$2.54</b>
G4040382	1½" x 180'	<b>\$7.27</b>



**TARTAN**  
**Masking Tape**

- Beige crepe paper
- 4.4 mil thickness
- 55m length
- ■ ASTM STANDARDS

Q#	width	price
G4308972	¾"	<b>\$1.51</b>
G4308963	1"	<b>\$1.83</b>
G4308954	1½"	<b>\$2.82</b>
G4308945	2"	<b>\$4.06</b>



**NASHUA**  
**Multi-Purpose Foil Tape**

- Heavy-duty aluminum foil
- Synthetic rubber adhesive
- 5 mil thickness
- ■ UL STANDARDS

Q#	roll	price
G1382832	48mm x 46m	<b>\$10.41</b>
G0902027	72mm x 46m	<b>\$12.67</b>



**ANTI-SEIZE**  
**PTFE Sealant Tape**

- Durable PTFE
- 10,000 psi max
- -400° F to 550° F

**Low Density**

Q#	roll	price
G2820623	½" x 260"	<b>\$0.50</b>
G0713361	¾" x 520"	<b>\$0.54</b>



**Poly-Temp Medium Density**

Q#	roll	price
G1132661	¼" x 520"	<b>\$1.07</b>
G0426176	½" x 260"	<b>\$1.49</b>
G1610655	¾" x 520"	<b>\$2.37</b>
G0321596	¾" x 520"	<b>\$3.79</b>



**Poly-Temp High Density**

Q#	roll	price
G2888356	½" x 520"	<b>\$2.37</b>
G2651555	¾" x 520"	<b>\$3.41</b>



**VELCRO**  
**Reclosable Fastener Tape**

- Strong, pressure sensitive and long lasting nylon
- Acrylic adhesive
- 1" x 75' roll

Q#	type
G3428031	hook
G1143265	loop

each **\$38.27**

**ETERNABOND**  
**Roof Repair Tape**

- For use with all roofs, surfaces, gutters, skylights, flashing, copings and tubing
- 1 hr functional cure
- Adheres to all materials except silicone
- Never dries or hardens
- UV stable
- 35 mil thickness

Q#	roll	price
G1430843	4" x 50' (16.6 sq-ft)	<b>\$70.99</b>
G2069365	6" x 50' (25 sq-ft)	<b>\$78.59</b>



**PARAFILM**  
**Laboratory Sealing Film**

- Standard grade
- Two-way stretch design

Q#	roll	price
G4312987	2" x 250'	<b>\$23.83</b>
G4455333	4" x 125'	<b>\$20.93</b>
G4455342	4" x 250'	<b>\$39.68</b>



**SCOTCH**  
**Double-Sided Foam Tape**

- Urethane foam
- Acrylic adhesive
- 62 mil thickness
- ¾" x 108' roll
- RoHS compliant

Q#	price
G4309076	<b>\$41.25</b>



**PARKER VIRGINIA**  
**Foam Insulation Tape**

- For hot or cold pipes
- Stops condensation and drips
- ⅛" thickness
- 2" x 30' roll

Q#	price
G2100411	<b>\$7.95</b>





# SHIPPING & OFFICE SUPPLIES

MORE THAN 800,000 ITEMS ONLINE

## VALUE BRAND Reclosable Bags

- Polyethylene
- Clear
- Zipper seal
- 100 pack

### 2 mil Thickness

Z#	size (l x w)	price
G1444064	3" x 2"	<b>\$0.98</b>
G2670884	4" x 3"	<b>\$1.15</b>
G2027891	5" x 3"	<b>\$1.29</b>
G1007176	6" x 4"	<b>\$2.19</b>
G1590425	6" x 6"	<b>\$3.47</b>
G1147431	9" x 6"	<b>\$3.99</b>
G3155451	12" x 9"	<b>\$7.39</b>
G3344424	15" x 12"	<b>\$10.54</b>

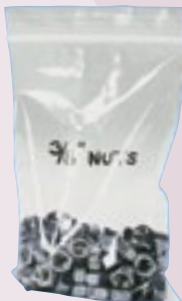

### 4 mil Thickness

Z#	size (l x w)	price
G1357982	4" x 3"	<b>\$1.98</b>
G3452075	6" x 4"	<b>\$3.95</b>
G1968355	9" x 6"	<b>\$7.50</b>

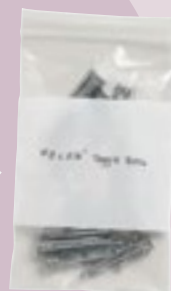

### 4 mil Thickness

- With write on block

Z#	size (l x w)	price
G0597021	5" x 3"	<b>\$2.87</b>
G0807143	6" x 4"	<b>\$4.07</b>
G0449032	9" x 6"	<b>\$8.38</b>

## VALUE BRAND Polyethylene Tubing

- 2 mil thick
- 2,150' length

Z#	width	price
G0367762	2"	<b>\$29.64</b>
G3001704	3"	<b>\$43.27</b>
G3455803	4"	<b>\$51.04</b>
G1828041	5"	<b>\$63.89</b>
G1751845	6"	<b>\$58.29</b>



## MIDWEST PACIFIC Polyethylene Tubing Rack

- 12" width

Z#	price
G2653551	<b>\$17.83</b>



## VALUE BRAND Mattress Bag

- LDPE
- Queen size
- 60" w x 92" l x 10" d
- 1.5 mil thickness

Z#	price
G3200267	<b>\$4.77</b>



## VALUE BRAND Bag Sealer

- Table top
- 12" seal length
- 3/32" seal width
- 6 mil max thickness
- 115 VAC, 580 W

Z#	price
G2873762	<b>\$102.20</b>



## MIDWEST PACIFIC Drawstring Parts Bag

- 5" x 3 1/4"
- Natural cotton
- 100 pack

Z#	price
G2169596	<b>\$22.34</b>



## VALUE BRAND Kraft Paper

- 8 1/2" roll diameter

### 30 lb Basis Weight

Z#	width	length	price
G1540935	12"	1,200'	<b>\$15.79</b>
G2877262	18"	1,200'	<b>\$15.99</b>
G1857651	24"	1,200'	<b>\$21.99</b>
G2397543	30"	1,200'	<b>\$26.99</b>
G2379736	36"	1,200'	<b>\$31.99</b>
G1144132	48"	1,200'	<b>\$44.99</b>

### 40 lb Basis Weight

Z#	width	length	price
G3961912	48"	900'	<b>\$48.27</b>

### 60 lb Basis Weight

Z#	width	length	price
G3486917	36"	600'	<b>\$33.65</b>



## VALUE BRAND Furniture Bag

- Polyethylene
- 46" w x 134" l
- 1 mil thickness

Z#	price
G2898463	<b>\$3.99</b>



## VALUE BRAND Heat Shrink Bag

- PVC
- 18" w x 24" l
- 1 mil thickness
- 40% max shrink
- 100 pack

Z#	price
G1796532	<b>\$42.17</b>



## VALUE BRAND Paper Dispenser and Cutter

- 24" width
- Holds 1 roll (NOT included)

Z#	price
G0253662	<b>\$46.15</b>

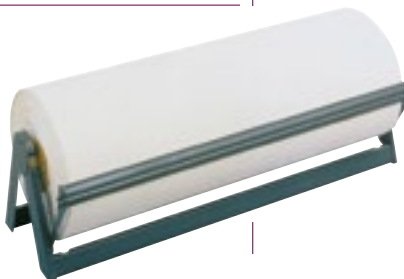

## VALUE BRAND Newsprint Grade Paper

- 30 lb basis weight
- Gray
- 1,200' length
- 24" width
- 8 1/2" roll diameter

Z#	price
G1618784	<b>\$25.78</b>



**PREGIS Packing Foam**

- Perforated in 12" increments
- White polypropylene
- 600' length
- 12" width
- 3/32" thickness



Q # price  
G2660831 **\$43.84**

**VALUE BRAND Dessicants**

- Montmorillonite clay
- Tyvek package
- 3 1/4" x 2 1/4"
- Protects up to .28 cu-ft
- 700 pack



Q # price  
G8484944 **\$70.87**

**VALUE BRAND Moving Pads**

- Cotton/poly blend



**Door Jamb Protector**

- Blue
- 24" w x 69" l

Q # price  
G2129197 **\$19.45**

**Chair Cover**

- Blue
- 39" w x 44" l



Q # price  
G0666513 **\$29.74**

**General Purpose**

- Blue/green

Q # size (w x l) price  
G3423743 80" x 72" **\$7.91**

G0664316 78" x 100" **\$19.79**



**Refrigerator Cover**

- Blue
- 33" w x 68" l

Q # price  
G0814432 **\$55.04**



**VALUE BRAND Bubble Wrap**

- Clear
- 16" width
- 60' length
- 3/16" bubble height



Q # price  
G2870481 **\$18.07**

**POLAR TECH Cold Packs**

- Viscous gel refrigerant
- 6" w x 4" l
- 6 oz
- Biodegradable
- 48 pack



Q # price  
G3725872 **\$9.18**

**VALUE BRAND Carton Sizer**

- Steel/plastic
- 2" length



Q # price  
G1682563 **\$14.88**

**POLAR TECH Insulated Shipping Kit**

- 7 lb max
- 204 cu-in
- 6" w x 4 1/4" d x 8" l
- 3 pack

includes foam container and carton

Q # price  
G0268624 **\$20.36**



**SHURTAPE Packing Tape**

- Clear
- 72 mm w x 100 m l
- 1.9 mil thickness
- 24 pack



Q # price  
G4563562 **\$53.17**

**START INTERNATIONAL Tape Dispenser**

- 4 slots
- 3" core size
- Blue

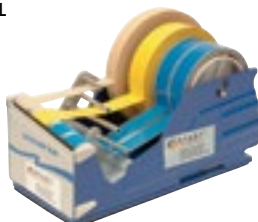

Q # price  
G4057523 **\$28.52**

**FP INTERNATIONAL Packing Peanuts**

- Recycled polystyrene
- Biodegradable
- 7.5 cu-ft



Q # price  
G1805912 **\$15.47**

**VALUE BRAND Shipping Cartons**

- 65 lb max
- Single wall
- 25 pack order quantity



Q #	dimensions	price/ctn
G4784543	4" w x 4" d x 4" l	<b>\$0.26</b>
G4285732	4" w x 4" d x 6" l	<b>\$0.42</b>
G4784552	6" w x 5" d x 6" l	<b>\$0.41</b>
G4285757	6" w x 6" d x 8" l	<b>\$0.55</b>
G4285836	14" w x 6" d x 14" l	<b>\$1.87</b>
G4285574	18" w x 18" d x 18" l	<b>\$3.03</b>
G4313294	24" w x 24" d x 24" l	<b>\$4.97</b>

**POLAR TECH Wine Cartons**

- Corrugated cardboard
- 3 1/4" w x 3 1/4" d x 12 1/2" l

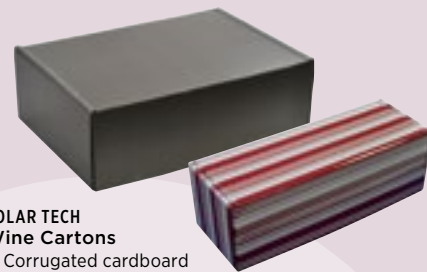

Q #	holds	color	price
G3613337	1 bottle	red & white striped	<b>\$6.74</b>
G3703804	1 bottle	champagne	<b>\$4.66</b>

**VALUE BRAND Multidepth Cartons**

- 65 lb max
- 25 pack order quantity



Q #	size	variable depth	price/ctn
G3783071	12" l x 10" w	6", 4"	<b>\$0.69</b>
G3783656	12" l x 12" w	8", 6", 4"	<b>\$1.01</b>



# SHIPPING & OFFICE SUPPLIES

MORE THAN 800,000 ITEMS ONLINE

### DYM0 Labelmaker

- 1 line max of print
  - 3/8", 1/2" tape width
  - Black vinyl
- includes 1/2" x 12' black tape roll

Z#	price
G3440105	\$28.29

### Tape Rolls

- 3/8" width
- 10' length

Z#	color
G0155775	black
G0155757	red
G0155766	blue

each **\$1.86**



### VALUE BRAND Shipping Labels

- Adhesive backed paper
- 50 pack

Z#	legend	size	price
G4371936	ORM D	2 1/2" x 1 1/2"	\$1.15
G4371631	fragile	3" x 2"	\$1.42



### HIGHLIGHT Stretch Wrap Dispenser

- For 12" to 18" roll width
- 3" core size

Z#	price
G2860952	\$61.85



### MARSH Spray Stencil Ink

Z#	color
G2770957	black
G2723235	white
G1161736	tan

each **\$4.29**



### MARSH 3" Roller

Z#	price
G1837157	\$46.94



### BAND-IT Band and Buckle Kit

- 1/2" band width
  - 100' length
- includes 100' band, 35 buckles and tote

Z#	price
G4291777	\$117.71



### MIP Strapping Cutter

- Black oxide steel with plastic handle
- For 3/4" strap width

Z#	price
G4180251	\$33.97

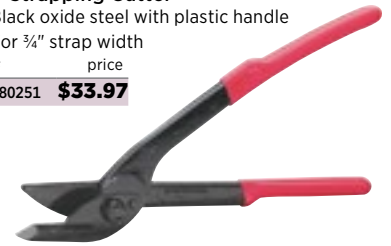

### VALUE BRAND Blank Wire Tags

- Manila
- 3 1/8" x 6 1/4"
- 1000 pack

Z#	price
G1624761	\$38.52



### VALUE BRAND Clear Stretch Wrap

- LLDPE
- Cast

Z#	width	length	gauge	price
G4316295	3"	600'	150	\$3.79
G4223125	5"	600'	150	\$4.99
G3975176	3"	700'	120	\$3.69
G4066352	5"	700'	120	\$4.49
G3947176	3"	1,000'	80	\$3.19
G3952347	5"	1,000'	80	\$3.79
G4079205	15"	1,000'	80	\$11.46
G4290237	18"	1,500'	80	\$15.19
G3988284	20"	1,500'	80	\$13.99



### VALUE BRAND Opaque Stretch Wrap

- Black
- LLDPE
- Cast

Z#	width	length	gauge	price
G4264172	3"	1,000'	80	\$15.14



### PAC STRAPPING PRODUCTS Plastic Strapping Kit

- Polypropylene
  - 1/2" strap width
  - 18mil strap thickness
  - 3000' strap length
- includes tensioner and (300) buckles

Z#	price
G0979045	\$49.76



### SIGNODE Steel Strapping

#### Strapping

Z#	width	thickness	length	breaking strength	price
G2877052	1/2"	.017"	300'	1,275 lb	\$42.19
G3209236	1/2"	.017"	3,635'	1,275 lb	\$172.49
G3354601	3/4"	.017"	300'	1,900 lb	\$44.86

#### Seals

- Pk 200

Z#	width	type	length	joint type	price
G2702551	1/2"	open	1 1/8"	double notch	\$11.68
G0484233	3/4"	open	1 1/4"	double notch	\$8.79

#### Tool

- For 1/2" strapping width
- For up to .023" thickness
- For flat surfaces

Z#	price
G2521172	\$1,874.24





**RUBBERMAID Mechanical Scale**

- 114 kg/250 lb capacity
- 0.5 kg/0.2 lb graduations
- Stainless steel

#	price
G3420051	<b>\$76.95</b>



**PELOUZE Digital Scale**

- 180 kg/400 lb capacity
- 0.2 kg/0.5 lb graduations
- Stainless steel

#	price
G3077855	<b>\$130.64</b>



**MEASURETEK Digital Scale**

- 200 kg/440 lb capacity
- 0.1 kg/0.2 lb graduations
- Diamond plated steel

#	price
G4272344	<b>\$130.49</b>



**EAGLE THERMOPLASTIC Weighing Dishes**

- Aluminum
- 100 pack

#	dia	capacity	price
G4020947	43mm	20 mL	<b>\$6.45</b>
G4216791	57mm	60 mL	<b>\$7.07</b>
G3950292	73mm	80 mL	<b>\$11.83</b>



**POLAR TECH Pallet Cover**

- Insulated
- For use with 48" x 40" pallets

#	price
G3664787	<b>\$83.28</b>



**RICE LAKE Calibration Weights**

- Cast Iron

#	size	price
G4792347	10 lb	<b>\$78.04</b>
G4792392	20 lb	<b>\$94.77</b>
G4792365	50 lb	<b>\$133.79</b>



**VALUE BRAND Pallet Bands**

- Rubber
- 6 1/4" width
- includes 2 of each: 29", 36" and 45" lengths

#	price
G3351677	<b>\$7.84</b>



**TYDENBROOKS Security Seals**

- HDPE
- 100 pack

**Lock Seal**

#	color	length	digits
G0390792	yellow	7"	7
G0561836	blue	7"	7

price **\$9.59**



**Pull Tight**

#	color	length	digits	pack	price
G5032702	blue	8"	7	100	<b>\$14.52</b>
G5033901	red	8"	7	100	<b>\$14.52</b>
G5032727	orange	9"	6	50	<b>\$14.34</b>



**VALUE BRAND Pallets**

- Stackable
- 2,200 lb dynamic load capacity
- 6,600 lb static load capacity
- 48" x 40"
- HDPE

#	color
G1054575	blue
G1716443	red

each **\$94.70**

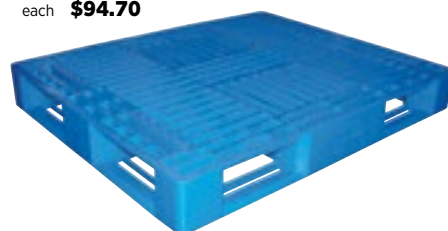

**SIGNODE Pallet Weasel**

- Helps feed steel and plastic strapping through pallet

#	price
G0816706	<b>\$19.07</b>



**BROOKS Security Seals**

- Polypropylene
- 100 pack

**Ring Flag Bi-Directional**

- Yellow
- 9" length
- 7 digits, 2 lines of 8 characters

#	price
G3787542	<b>\$11.82</b>



**Padlock**

- Blue
- 2" length
- 7 digits, 2 lines of 13 characters

#	price
G4767944	<b>\$25.10</b>



**Ladder Lock**

- Green
- 10 1/2" length
- 7 digits, 1 line of 7 characters

#	price
G4767962	<b>\$16.15</b>





# SHIPPING & OFFICE SUPPLIES



### RITE IN THE RAIN Retractable Ballpoint Pens

- Fine point
- Plastic barrel
- 0.9mm point

Z#	ink	barrel	price
G4702056	blue	chrome and blue	<b>\$8.40</b>
G3892253	black	chrome and black	<b>\$10.30</b>

### 5.11 TACTICAL Double Duty Pen

- Medium point
- Black ink
- Black aluminum barrel
- Steel pocket clip

Z#	price
G6209016	<b>\$39.99</b>



### SHARPIE Permanent Markers

- Fine tip
- Black ink
- Waterproof

Z#	price
G0156457	<b>\$13.05</b>



### VALUE BRAND Rubber Band Ball

- 3<sup>3</sup>/<sub>16</sub>" length
- 1/8" width
- Assorted colors

Z#	price
G3373361	<b>\$2.52</b>

### QUARTET Laser Pointer

- Red beam
- Black plastic
- 655' projection
- 6 1/2" length

Z#	price
G2401402	<b>\$13.84</b>



### SAUNDERS Storage Clipboards

- 8 1/2" x 11" sheet size
- Orange plastic
- 1/2" clip capacity
- 1" storage capacity

includes calculator

Z#	price
G3061624	<b>\$9.33</b>



### SAUNDERS Storage Clipboards

- Black aluminum
- 1" clip capacity
- 1 1/2" storage capacity

Z#	price
G0866652	<b>\$24.93</b>



### AEGIS Desk Phone

- Single line
- Red
- Bell ringer

Z#	price
G3063952	<b>\$25.73</b>



### SAUNDERS Three Ring Binders

- Aluminum
- 8 1/2" x 11" sheet size

Z#	ring size	price
G2728643	1"	<b>\$18.99</b>
G2748961	2"	<b>\$19.99</b>



### SKILCRAFT Aerosol Duster

- 10 oz net weight
- VOC compliant

Z#	price
G1262475	<b>\$6.81</b>



### MASTER CASTER Flexible Desk Grommet

- 2 3/8" diameter
- 2 1/4" opening
- Black plastic

Z#	price
G0676864	<b>\$2.14</b>



### IRIS Table Chest

- 3 drawers
- Letter size
- 10 5/8" h x 13 5/8" w x 9 5/8" d
- Black polypropylene

Z#	price
G5004772	<b>\$13.29</b>



### VALUE BRAND Clipboards

- Plastic
- 8 1/2" x 11" sheet size
- 1/2" clip capacity

Z#	color	price
G3015266	royal blue	
G1069652	black	
G2953763	red	
G0275527	dark green	
each		<b>\$2.49</b>



### VALUE BRAND Bulletin Board

- Cork
- Aluminum frame
- 48" x 36"

Z#	price
G0639956	<b>\$26.54</b>



### OFFICEMATE Letter Tray

- Black plastic
- 15 5/8" l x 11 1/2" w x 5 3/4" h
- 2 compartments

Z#	price
G1193035	<b>\$24.75</b>



### VALUE BRAND Push Pins

- Plastic/metal
- 3/4" length

Z#	price
G1648306	<b>\$1.35</b>



**GARVEY**  
Queue System Ticket System

**Dispenser**

- Red plastic
  - Wall or mount or metal stand
  - Holds one roll of tickets
- includes mounting hardware

Q #	price
G1910851	<b>\$22.45</b>



**Ticket Roll**

- 22 sets of service numbers (0-99)

Q #	price
G2857531	<b>\$10.17</b>



**Stand**

- Powder coated metal
- includes sign

Q #	price
G3325436	<b>\$153.31</b>



**VALUE BRAND**  
Dry Erase Boards

- White
  - Aluminum frame
- includes mounting hardware and tray

Q #	size	price
G2977764	48" x 36"	<b>\$32.30</b>
G0799976	72" x 48"	<b>\$86.71</b>

**MASTER LOCK**  
Cash Box

- 7 compartments
- Black steel
- Keyed latch
- 11" w x 7 3/4" d x 4" h

Q #	price
G1139765	<b>\$8.37</b>



**IRIS**  
File Boxes

- Clear polypropylene
- Open top
- Letter size

Q #	depth	price
G5004797	4"	<b>\$3.20</b>
G5004781	7 7/8"	<b>\$4.99</b>



**IRIS**  
Organizing Cart

- 7 drawers
- 12" w x 14 1/4" d x 42 1/2" h
- Polypropylene

Q #	price
G5004736	<b>\$41.07</b>



**CLEAN REMOTE**  
Universal Spillproof TV Remote

- White
- For use with Coby, GE, Hitachi, Insignia, JVC, LG, Magnavox, Panasonic, RCA, Samsung, Sony, Vizio, Zenith

Q #	price
G2032405	<b>\$9.33</b>



**COTTERMAN**  
Step Stand

- 2 steps
- Gray powder coated steel
- 500lb load capacity
- 20" top step height
- 12" x 12" platform

Q #	price
G4800397	<b>\$95.95</b>



**GENEVA**  
Wall Mount Quartz Cubicle Clock

- Analog
- 12 hour
- 8 1/2" diameter
- Requires 1 AA battery
- Black plastic case, white face

Q #	price
G2189905	<b>\$7.44</b>



**NIB**  
Wall Mount Clock

- Analog
- 12 hour
- 9 1/2" diameter
- Electric with 5' cord
- Brown plastic case, white face

Q #	price
G2192915	<b>\$23.08</b>



**BRIGHTSTAR**  
Universal TV Remote

- Black
- For use with Coby, GE, Hitachi, Insignia, JVC, LG, Magnavox, Panasonic, RCA, Samsung, Sony, Vizio, Zenith

Q #	price
G0270882	<b>\$5.40</b>



**PYRAMID**  
Mechanical Time Clock

- Wall or desk mount
  - LCD display
  - Records time, date, 14 selectable messages
- includes 25 time cards, keys, ribbon and manual

Q #	price
G4275844	<b>\$431.13</b>



**GLARO**  
Wet Umbrella Bag Holder

- Floor stand
- 43" height
- Satin black finish
- Holds up to 400 umbrella bags (sold separately)

Q #	price
G6389397*	<b>\$176.69</b>

**Umbrella Bags**

- 100 pack

Q #	price
G8522473	<b>\$20.99</b>



**MMF INDUSTRIES**  
Coin Trays

- Plastic

**Coin storage**

- Pennies (\$5 capacity), nickels (\$20 capacity), dimes (\$50 capacity), quarters/half dollars (\$100 capacity)
- Sand
- 6 1/4" w x 3 3/8" d x 1 1/8" h

Q #	price
G1242087	<b>\$4.86</b>

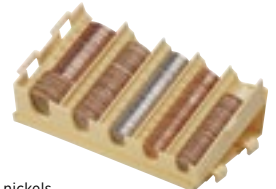

**Rolled coin storage**

- Pennies (\$5 capacity), nickels (\$20 capacity), dimes (\$50 capacity), quarters (\$100 capacity)
- 11 1/2" w x 4" d x 4 1/2" h
- 4 pack

includes (1) each red, blue, green and orange

Q #	price
G0275301	<b>\$20.55</b>





# SHIPPING & OFFICE SUPPLIES

## BLOOMFIELD Coffee Brewer

- 64 oz
- 3.9 gal/hr
- 2 warming stations
- Stainless steel
- Decanters not included



Z#	price
G1205346	<b>\$373.09</b>

## BLOOMFIELD Decanter

Z#	price
G1856732	<b>\$6.75</b>



## BLOOMFIELD Filters

- 1,000 pack



Z#	price
G2209006	<b>\$12.04</b>

## MR. COFFEE Coffee Grinder

- Single hopper
- 12 cup
- 120V
- White plastic
- 8 7/8" height



Z#	price
G1300862	<b>\$18.34</b>

## SOLO CUP Stir Straws

- Red and white
- 5"
- 1,000 pack



Z#	price
G0579381	<b>\$2.52</b>

## VALUE BRAND Disposable Cone Cups

- 4.25 oz
- White paper

Z#	pack	price
G4974995	200	<b>\$3.25</b>
G4975004	1,000	<b>\$18.68</b>



## SHARP Microwave Oven

- 120V @ 60 Hz
- 1,000W
- Stainless steel
- .95 cu-ft
- 20 1/2" w x 16" d x 12 1/8" h



Z#	price
G2670236	<b>\$439.99</b>

## DINEX Traycovers

- Paper
- 1,000 pack



Z#	color	dimensions	price
G6537684*	iris garden	10 7/16" x 18 1/2"	<b>\$117.53</b>
G6575423*	carnation medley	11 1/8" x 19 1/2"	<b>\$131.80</b>
G6574066*	marbled elegance	11 1/8" x 19 1/2"	<b>\$131.80</b>

## WISCO Ovens

- Stainless steel
- 120V



### 12" Pizza

- Digital
- Cooking chamber: 13" w x 13" d x 3" h
- 12.1A
- 6' cord

Z#	price
G4362522	<b>\$110.27</b>



### 16" Pizza

- Mechanical
- Cooking chamber: 17 1/2" w x 17 1/2" d x 2 9/16" h
- 14.2A
- 5' cord

Z#	price
G4362547	<b>\$310.69</b>



### Convection

- Mechanical
- Cooking chamber: 14" w x 11" d x 8 3/8" h
- Cooking surface: 14" x 11"
- 10.9A
- 53" cord

Z#	price
G4362556	<b>\$525.14</b>

## TABLECRAFT PRODUCTS COMPANY Bar Caddy

- Black ABS plastic
- 5 3/4" w x 9 1/2" l x 4" h



Z#	price
G1933425	<b>\$4.99</b>

## MICROFRIDGE Refrigerator, Ice Compartment and Microwave

- 3.6 cu-ft refrigerator
- .3 cu-ft freezer
- .7 cu-ft microwave
- 18 3/8" w x 20 1/8" d x 44 1/8" h
- 5' cord



Z#	price
G5197376	<b>\$693.32</b>

## RUBBERMAID Pitchers

- Polyethylene



Z#	size	color	price
G3041866	2 qt	almond	<b>\$11.52</b>
G3226797	2 1/4 qt	periwinkle	<b>\$6.94</b>

## TABLECRAFT PRODUCTS COMPANY Bar Mat

- Black rubber
- 18" x 12"



Z#	price
G0904337	<b>\$13.91</b>

**PHOENIX Napkins**

- 18" square
- 12 pack

Q#	color
G4222942	burgundy
G3952471	royal blue
G4150011	white

each **\$41.49**



**FASTENATION Table Skirting Clips**

- 2½" width
  - ¾" to 1" thickness
  - Polyester
  - 100 pack
- includes hook and loop

Q#	price
G5022534	<b>\$46.39</b>

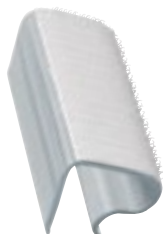

**VOLLRATH Ladle**

- Stainless steel
- 6 oz

Q#	price
G1035587	<b>\$3.81</b>



**CHICAGO METALLIC Bread Pans**

- Aluminized steel

Q#	item	dimensions	price
G5945931*	5-strap	8½" w x 25¾" l x 2¼" d	<b>\$91.69</b>
G5866603*	6-strap	6" w x 25¾" l x 2¼" d	<b>\$52.61</b>

**CRESTWARE Ice Scoop**

- Stainless steel
- 12 oz

Q#	price
G4693333	<b>\$2.68</b>



**ITI Ice Bucket**

- 4 qt
- Stainless steel

Q#	price
G8220265*	<b>\$19.46</b>



**PHOENIX Tablecloths**

- 70" x 52"

Q#	color
G4048405	red
G4230816*	forest green

each **\$30.21**



**CHICAGO METALLIC Sheet Pans**

- Aluminum
- 18 gauge

Q#	dimensions	price
G4659417	18" w x 13" l x 1" d	<b>\$10.99</b>
G4658342	15" w x 21" l x 1" d	<b>\$23.56</b>



**VOLLRATH Stainless Steel Cookware**  
includes domed cover

Q#	item	capacity	dia	price
G3722101	sauce pan	4 qt	8"	<b>\$31.37</b>
G3647621	stock pot	27 qt	12½"	<b>\$103.20</b>

**VOLLRATH Pan Grip**

- Silicone
- Fits 8" and 10" pans
- 5" length
- 400°F temperature resistance
- Black

Q#	price
G3677353	<b>\$1.71</b>



**VOLLRATH Aluminum Cookware**

Q#	item	dia	price
G3647481	non-stick fry pan	8"	<b>\$14.69</b>
G3735356	non-stick fry pan	12"	<b>\$32.49</b>
G3685482	sauce pan	7½"	<b>\$13.24</b>

**SAN JAMAR Cutting Boards**

- Four piece set
- Red, yellow, green, and white
- Copolymer
- 18" x 24"
- ½" thickness

Q#	price
G2099736	<b>\$137.93</b>



**OLFA Cutting Mat**

- 36" x 24"
- 12" thickness
- One side green with white lines, other side solid green
- Use with utility knives and rotary cutters

Q#	price
G4759447	<b>\$71.01</b>





# SHIPPING & OFFICE SUPPLIES

MORE THAN 800,000 ITEMS ONLINE

## WARING COMMERCIAL Blenders

- Die cast base, stainless steel container
- ½ Hp
- 120 V, 3 A
- 2 speed
- 16½" height

Item #	size	price
G7482316	32 oz	<b>\$291.13</b>
G7487487	40 oz	<b>\$327.82</b>



## DEXTER RUSSELL Boning Hook

- Steel hook with red polypropylene handle
- 4" length

Item #	price
G1105912	<b>\$9.62</b>



## TABLECRAFT PRODUCTS COMPANY Salad Dressing Dispensers

- 48 oz
- ABS maroon top
- Set of 10 ID collars includes (6) holders with (6) splash guards

Item #	price
G2241504	<b>\$127.44</b>



## DEXTER RUSSELL Skinning Knife

- Steel with white polypropylene handle
- 6" length

Item #	price
G2690073	<b>\$15.42</b>

## CRESTWARE French Whip

- 10" length
- Stainless steel

Item #	price
G6142175	<b>\$4.11</b>



## TABLECRAFT PRODUCTS COMPANY Salt and Pepper Shakers

- 1oz
- Glass with chrome top
- 24 pack

Item #	price
G0733372	<b>\$20.62</b>



## DEXTER RUSSELL Knife Scabbard

- For 5" to 9" knives

Item #	price
G1093206	<b>\$5.15</b>

## TABLECRAFT PRODUCTS COMPANY Pourer Set

- 1" dia
- 3.2" height
- Amber plastic

Item #	price
G0868847	<b>\$10.31</b>



## TABLECRAFT PRODUCTS COMPANY Soy Sauce Bottles

- 5oz
- 12 pack

Item #	price
G1278882	<b>\$22.92</b>



## LENOX DINNERWARE Goblets

- Glass
- 12 pack

Item #	type	size
G7082591*	bordeaux	27 oz
G6894115*	beaujolais	28 oz

each **\$141.41**



## THERMOS Insulated Beverage Bottle

- 17 oz
- 10" height
- Stainless steel

Item #	price
G4390172	<b>\$10.47</b>



## TABLECRAFT PRODUCTS COMPANY Lobster Cracker

- Double jaw
- 6.25" x 1.5"
- Chrome plated metal

Item #	price
G1112693	<b>\$1.99</b>



## VOLLRATH Funnels

- Stainless steel

Item #	size	dia	height	price
G0985494	32 oz	6¾"	7¼"	<b>\$34.89</b>
G1990572	64 oz	8¾"	8¾"	<b>\$48.27</b>



## STRAHL Glasses

- Polycarbonate
- 12 pack

Item #	type	size	height	dia	price
G4580134	pilsner	9½ oz	6¾"	3"	<b>\$69.96</b>
G5949325*	highball	10 oz	5¾"	3"	<b>\$102.88</b>
G5905785*	stacking	14 oz	6"	3¼"	<b>\$89.86</b>
G6021915*	double rocks	12 oz	3¼"	3¾"	<b>\$108.91</b>



**CAMBRO Grapefruit Bowls**

- 11 oz
- 6" dia
- Beige
- 48 pack

#	price
G2232867	<b>\$111.94</b>



**CAMBRO Nappie Bowls**

- Beige
- 48 pack

#	size	dia	price
G3023517	12 1/2 oz	5"	<b>\$96.34</b>
G1672596	15 1/4 oz	5 1/4"	<b>\$111.94</b>



**CARLISLE Rimmed Fruit Bowls**

- White melamine
- 5 oz
- 4.96" dia
- 48 pack

#	price
G4404644	<b>\$60.61</b>



**DINEX Tulip Cups**

- Clear plastic
- 5 oz
- 3 3/4" dia
- 48 pack

#	price
G2967133	<b>\$99.79</b>



**WALKERS Shortbread Cookies**

- 2 cookies/pack
- 144 pack

#	price
G6569211*	<b>\$151.73</b>

**DINEX Insulated Bowls**

- 5 oz
- Plastic
- 48 pack

**Style 1 (3 1/4" dia)**

#	color	price
G6248636*	onyx	<b>\$92.12</b>
G6248645*	mauve	
G6248654*	blue	
G6248663*	teal	



**Style 2 (3 1/2" dia)**

#	color	price
G7263882*	onyx	<b>\$100.93</b>
G7263891*	blue	
G7263907*	latte	
G7263916*	green	
G7263925*	plum	
G7263934*	sage	



**CARLISLE Dinner Plates**

- 10 1/2" dia
- Sunset orange
- Melamine
- 12 pack

#	size	dia	price
G0634121*	12 1/2 oz	5"	<b>\$114.32</b>



**EARTH FRIENDLY PRODUCTS Fruit and Vegetable Wash**

#	size	price
G0454465	1 gal	<b>\$12.94</b>



**JIF Peanut Butter**

- 1.5 oz cups
- 36 pack

#	item	price
G6646945*	chocolate silk	<b>\$25.92</b>
G6761185*	creamy	<b>\$24.33</b>

**OFFICE SNAX Snacks and Candy**

**Mixed Candy**

- 2 lb
- 12 pack

#	price
G7051581*	<b>\$111.17</b>



**Soft and Chewy Candy**

- 2 lb
- 12 pack

#	price
G6529975*	<b>\$111.17</b>



**Graham Cracker Pretzels**

- 32 oz
- 6 pack

#	price
G6721461*	<b>\$101.18</b>



**Mini Pretzels**

- 40 oz
- 6 pack

#	price
G7153781*	<b>\$73.42</b>



**Peanut Butter Pretzels**

- 44 oz
- 6 pack

#	price
G6960597*	<b>\$93.25</b>



**Peppermint Puffs**

- 44 oz
- 6 pack

#	price
G6754815*	<b>\$85.40</b>



**Pistachios**

- 11 oz
- 36 pack

#	price
G6988624*	<b>\$471.49</b>



**Red Licorice**

- 15 oz
- 12 pack

#	price
G6440664*	<b>\$102.91</b>





# SHIPPING & OFFICE SUPPLIES

## HONEY-CAN-DO Clothespins

- Spring opening
- Up to 10 lb per pin

### Wooden

Z#	pack	price
G0290936	24	<b>\$1.08</b>
G1103286	100	<b>\$3.74</b>



### Plastic

Z#	pack	price
G2449221	24	<b>\$1.71</b>
G1871091	100	<b>\$6.60</b>



### Bag

Z#	price
G4563483	<b>\$3.94</b>



## HONEY-CAN-DO Retractable Clotheslines

Z#	length	price
G4616132	8'	<b>\$8.94</b>
G4601703	40'	<b>\$13.01</b>

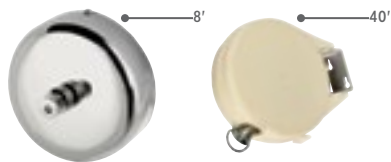

## HONEY-CAN-DO Over-the-Door Hanger Holder

- Chrome/black metal

Z#	price
G4568085	<b>\$7.09</b>



## HONEY-CAN-DO Wood Hangers

- Open hook
- 17" width
- Cherry finish
- 24 pack

Z#	price
G0189734	<b>\$21.85</b>

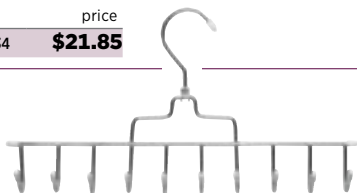

## HONEY-CAN-DO Tie/Belt Hanger

- Chrome with white vinyl tips

Z#	price
G4632223	<b>\$6.44</b>

## CSL FOODSERVICE AND HOSPITALITY

### Bellman Carts

- Chrome metal
- 43" x 23" deck
- 73" height
- 1,200 lb load capacity

Z#	color	price
G5463963*	red	<b>\$772.25</b>
G5463972*	brown	
G5463981*	green	
G5463997*	blue	
G5464006*	black	

each



## CSL FOODSERVICE AND HOSPITALITY

### Luggage Rack

- Curved
- Wood with mahogany finish
- Holds up to 150 lbs
- 23" w x 17" d x 19 1/4" h
- 3 pack

Z#	price
G3395865	<b>\$205.53</b>



## SAFCO Garment Rack

- Stand alone
- Holds up to 16 garments
- Bamboo with cherry finish, chrome hooks

Z#	price
G5628034*	<b>\$144.21</b>



## HONEY-CAN-DO Drying Rack

- 14 3/8" w x 29 3/8" l x 42" h
- Steel

Z#	price
G4631112	<b>\$22.03</b>

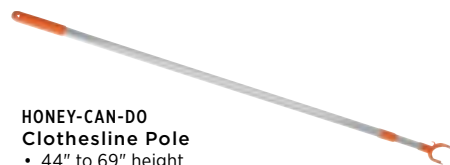

## HONEY-CAN-DO Clothesline Pole

- 44" to 69" height
- Aluminum

Z#	price
G4632196	<b>\$4.70</b>

## HONEY-CAN-DO Garment Rack

- Expandable
- Steel
- includes locking casters

Z#	price
G4599682	<b>\$22.34</b>



## HONEY-CAN-DO Storage Closet

- Steel
- Double door
- 60" w x 20" l x 63" h
- includes shoe organizer

Z#	price
G4522375	<b>\$32.34</b>





**EDSAL Shop Desks**

- Steel
- Lockable
- Left pedestal
- 4 drawer
- Gray
- 39" w x 28 3/4" d x 55 1/2" h

#	price
G2510785	<b>\$761.94</b>



**EDSAL Shop Desks**

- Steel
- Lockable
- No pedestal
- 1 drawer
- Beige
- 34" w x 30 1/4" d x 55 1/2" h

#	price
G2702122	<b>\$338.96</b>



**TENNSCO Bookcase**

- Steel
- 5 Shelves
- 38" w x 12" d x 60" h
- Black

#	price
G1581535	<b>\$239.94</b>

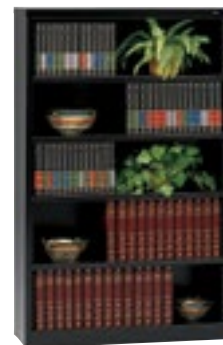

**VALUE BRAND Folding Chair**

- Steel frame with white plastic seat
- 9 3/4" back height
- 15 1/2" w x 17" d x 33 1/8" h

#	price
G1964627	<b>\$34.59</b>



**VALUE BRAND Adjustable Worktables**

- 34 1/2" to 35 1/2" h

**Without Backsplash**

- Stainless steel top
- Galvanized steel frame and shelf

#	size	shelf	price
G1913737	48" x 24"	yes	<b>\$367.73</b>
G2231266	60" x 30"	no	<b>\$405.74</b>

**With Backsplash and Shelf**

- Stainless steel

#	size	price
G3454613	72" x 30"	<b>\$733.98</b>



**VALUE BRAND Stools with Backrest**

- 14" dia
- 250 lb capacity
- 24" to 33" height
- Black

#	seat	price
G1887776	hardboard	<b>\$57.49</b>
G2351763	padded	<b>\$65.38</b>



**VALUE BRAND Folding Chair**

- Steel
- 18 1/2" w x 20" d x 29 1/4" h
- Beige

#	price
G2197946	<b>\$12.99</b>



**NATIONAL PUBLIC SEATING Swivel Stool**

- 24" to 28" height
- Gray

#	price
G7614984	<b>\$90.13</b>



**VALUE BRAND Folding Tables**

- Steel frame with plastic top
- 72" w x 30" d x 30" h

#	top color	top thickness	price
G0642686	walnut	3/4"	<b>\$138.61</b>
G4165865	gray	1 3/4"	<b>\$76.44</b>
G0329637	white	2"	<b>\$55.99</b>



**EDSAL Machine Stand**

- Steel
- 24" w x 18" d x 30" to 36" h
- 1,500 lb capacity

#	price
G1454354	<b>\$83.61</b>



**VALUE BRAND Round Stools**

- 15" dia
- 250 lb capacity
- Hardboard seat

#	height	price
G3103816	24"	<b>\$34.49</b>
G1774421	30"	<b>\$35.68</b>



**VALUE BRAND Stool Cushion**

- Brown polyester
- 14" dia
- 2" height

#	price
G0937815	<b>\$25.16</b>





# SHIPPING & OFFICE SUPPLIES

## VALUE BRAND

### Task Chair

- Black steel
- 15½" w x 14" d x 27¾" to 32¼" h
- 6" back height
- Upholstered seat with 2½" padding

Z#	color	price
G1311021		<b>\$80.30</b>



## BEVCO

### Task Chair

- Five-legged plastic base
- Gray fabric seat
- 18" w x 17" d x 17" to 22" h
- 10" back height

Z#	price
G4069475	<b>\$203.86</b>



## VALUE BRAND

### Stacking Chairs

- Black steel frame
- Fabric seat
- 17½" w x 21" d x 33½" h

Z#	color
G4333987	<i>burgundy</i>
G4334014	<i>blue</i>

each **\$35.49**

## VALUE BRAND

### Executive Chairs

- 30½" w x 27" d x 42½" to 45½" h
- Fixed arm
- Vinyl

Z#	color	capacity	price
G2890763	<i>oxblood burgundy</i>	250 lb	<b>\$172.21</b>
G0891073	<i>black</i>	350 lb	<b>\$241.19</b>



## CORTECH

### Arm Chairs

- 19" w x 18" d x 18" h
- Polyethylene
- 1,500 lb capacity
- Can be filled with sand to weigh down

Z#	color	price
G5966021*	<i>green</i>	<b>\$244.06</b>
G5951023*	<i>slate blue</i>	<b>\$298.02</b>



## SAFCO

### Ball Chairs

- 17½" dia
- 23" height
- PVC ball
- Polyester mesh fabric
- Steel legs

Z#	color
G5546694*	<i>grass</i>
G5694394*	<i>crimson</i>
G6120046	<i>black</i>

each **\$141.20**



## REGENCY

### Captain's Chair

- 24" w x 25" d x 31" h
- Wood frame with vinyl upholstery
- 250 lb capacity
- Fixed arm

Z#	price
G7081155*	<b>\$110.63</b>

## HON

### Guest Chairs

- 20" w x 18¼" d x 19¼" h
- 15" back height
- Steel frame with polypropylene seat
- 250 lb capacity
- Lumbar support

Z#	color
G5921623*	<i>burgundy</i>
G5926417*	<i>black</i>

each **\$152.79**



## SAFCO

### Guest Chairs

- 16" w x 25" d x 16" h
- 25" back height
- Steel frame with leather seat

Z#	color
G5502375*	<i>black</i>
G5513094*	<i>brown</i>
G5735301*	<i>red</i>
G5495436*	<i>white</i>

each **\$228.39**



## AMPLIVOX SOUND SYSTEMS

### Lectern

- Wood with mahogany finish
- 21" w x 15" d x 43" h
- includes speaker, amp and microphone*

Z#	price
G5683684*	<b>\$835.36</b>



**RUBBERMAID High Chair**  
 • Plastic  
 • 23½" w x 23½" d x 29¾" h

⑦ # price  
 G3433762 **\$149.14**



**AEROBED Air Mattress**  
 • 74" l x 39" w x 9" h  
 • 300 lb capacity  
 includes hands-free pump and carry bag

⑦ # price  
 G1656627 **\$126.42**



**FOUNDATIONS Hideaway Crib**

• Solid wood  
 • Natural color  
 • 26" w x 39" l x 38¾" h  
 includes (1) 3" mattress and (4) 4" casters

⑦ # price  
 G6395304\* **\$249.65**



**FOUNDATIONS Play Yard Crib**

• Steel  
 • Gray color  
 • 28½" w x 40¼" l x 29½" h  
 includes (1) ½" mattress and carry bag

⑦ # price  
 G5260105 **\$99.90**



**FOUNDATIONS Folding Cribs**

**Solid wood**  
 • Cherry color  
 • 26" w x 39½" l x 36¼" h  
 includes (1) 2" mattress and (4) 4" casters

⑦ # price  
 G6672075\* **\$249.90**



**Steel**  
 • White color  
 • 28" w x 40" l x 43" h  
 includes (1) 4" mattress and (4) 4" casters

⑦ # price  
 G4567911 **\$279.90**



**REGENCY Bookcases**  
 • Laminate  
 • 32" w x 14" d x 47" h

**4 Shelves**  
 ⑦ # finish price  
 G6295633\* mahogany **\$301.84**

**2 Shelves**  
 ⑦ # finish price  
 G6295642\* cherry **\$149.89**  
 G6295651\* mahogany **\$199.78**



**NUDELL Award Plaque**  
 • 8½" x 11"  
 • Mahogany finish MDF  
 • Plastic window

⑦ # price  
 G2800427 **\$10.25**



**VALUE BRAND Document Frame**  
 • 8½" x 11"  
 • Black plastic frame

⑦ # price  
 G0720824 **\$3.65**



**ADVANTUS Framed Motivational Print**  
 • 30" x 24"  
 • Black plastic frame

⑦ # price  
 G5639934\* **\$70.29**



**AMERICAN METALCRAFT Risers**

includes (1) 5" cube, (1) 7" cube and (1) 9" cube

**Bamboo**  
 ⑦ # finish  
 G6415062\* mahogany  
 G6826023\* natural  
 each **\$60.95**



**Wood**  
 ⑦ # finish  
 G6797332\* mahogany  
 G6796142\* black  
 each **\$67.56**



**NUDELL Silk Ivy Plant**  
 • 7" height

⑦ # price  
 G2367477 **\$38.60**



**REGENCY Coffee Tables**  
 • 13" height

**Round (37" dia)**  
 ⑦ # finish  
 G6494783\* cherry  
 G6586395\* medium oak  
 G6721233\* mocha walnut  
 each **\$165.03**



**Square (37" x 37")**  
 ⑦ # finish  
 G7229467\* cherry  
 G6932746\* medium oak  
 G6740745\* mocha walnut  
 each **\$165.03**



**VALUE BRAND Picnic Table**  
 • Galvanized steel frame  
 • Blue perforated metal top  
 • 72" w x 62" d x 30" h

⑦ # price  
 G6043536 **\$481.20**

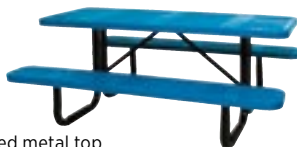

**VALUE BRAND Bike Racks**  
 • Galvanized steel  
 • 36" w x 48" l x 30" h

⑦ # type holds price  
 G4151436 single sided 4 bikes **\$283.11**  
 G4047872 double sided 8 bikes **\$329.23**



**VALUE BRAND Outdoor Cedar Bench**  
 • 21" w x 48" l x 32" h  
 ⑦ # price  
 G5843485\* **\$351.80**



Zoro  
909 Asbury Drive  
Buffalo Grove, IL 60089

PRESORT STD  
U.S. POSTAGE  
PAID  
Zoro Tools, Inc.

 **FREE** UPS Ground shipping  
on orders of \$50 or more\*

\* For more details visit [www.zoro.com/shipping/](http://www.zoro.com/shipping/)

 **CALL TOLL FREE**  
**855.BUY.ZORO (855.289.9676)**  
monday thru friday 7 am to 7 pm (CT), saturday 7am to 3:30pm (CT)

se habla español

© 2015 Zoro Tools, Inc.





# CUSTOMER FAVORITES»

As impossible as it was to choose (because all of our products are awesome), these picks stand out as your favorites. Find these cherished choices, and other contenders for the title, **online at zoro.com.**

**SUMP PUMP »**  
G1203237





**HYDRATION PACK »**  
G4583065

**PORTABLE TOOL BOX »**  
G0816715



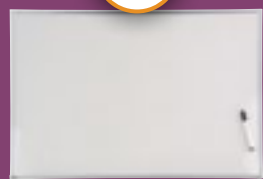

**DRY ERASE BOARD »**  
G2977764

**DRILL BIT SHARPENER »**  
G1519253



**AA-BATTERIES »**  
G2205445



**WALL MOUNT FAN »**  
G2383911



**SAFETY GLASSES »**  
G1030836





**COMPRESSOR OIL »**  
G2911063



**FIRE EXTINGUISHER »**  
G4152005



**FREEZER POPS »**  
G0284304

**LOCKING PLIERS »**  
G0671501

 **[www.zoro.com](http://www.zoro.com)** » more than 800,000 unique items online