



**Design &  
Manufacturing Ltd.**



# HDD & Cable Installation Tools 2024/2025 Product Catalog

HDD Pullback Swivels



Swivels & Connectors

Pulling & Support Grips



Cable Pulling Eyes

Duct Installation



Manhole Tools

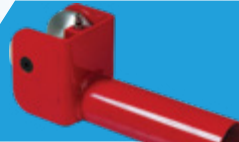

Cable Lubricants



Cable Pullers



Duct Rodders



Line Blowing



Overhead Products



1-888-794-8357  
[www.dcdesign.com](http://www.dcdesign.com)

# About DCD Design

---

At DCD Design & Manufacturing Ltd., we produce high quality Cable Installation, Directional Drilling, and Overhead Line Stringing Tools. DCD Design is driven by our customers' needs and by our own commitment to service those customers. Every effort is made to provide customers with the product they need, when they need it.

We maintain our inventory levels to satisfy 99% of orders without delay, and 90% of orders are shipped on the same day. From our integrated Sales and Engineering office, we offer the fastest turn-around in the industry to meet your deadlines.

We are constantly working to supply a high-quality product at a competitive price and all our products are fully tested and come with a six month guarantee (three months for Horizontal Directional Drilling products).

We are ISO 9001:2015 certified, which emphasizes our commitment to superior product quality and customer service.

Utilities, contractors, distributors and competitors alike recognize the high standards set by our Customer Service and the products we manufacture. Customers realize that help with field problems, the ability to react to a new need, and that extra effort required to help get the job done are all part of the DCD commitment.

## Company Quality Policy

---

It is DCD Design & Manufacturing Ltd's ongoing goal to provide a product that consistently satisfies the customer's stated and implied needs, and to continually improve the effectiveness of the quality management system.

## Follow us on social media

---





# ISO 9001 Certified



## CERTIFICATE OF REGISTRATION

This is to certify that

### DCD Design & Manufacturing Ltd.

180 - 6620 McMillan Way, Richmond, British Columbia, V6W 1J7, Canada

operates a

### Quality Management System

which complies with the requirements of

### ISO 9001:2015

for the following scope of certification

**Design, development, manufacture and sales of tools and accessories for cable installation and directional drilling.**

Certificate No.: CERT-0108034  
File No.: 1604452  
Issue Date: October 19, 2020

Original Certification Date: November 10, 2009  
Certification Effective Date: December 12, 2020  
Certificate Expiry Date: December 11, 2023

Heather Mahon  
Global Head of Technical Services  
SAI Global Assurance



Registered by SAI Global Assurance (SAI Global), 21 Canton Court, Suite 180, Toronto, Ontario M5H 1K7, Canada. This registration is subject to the SAI Global Terms and Conditions for Certification. Where applicable, our staff will be restricted in carrying out this assignment. SAI Global accepts responsibility only for errors in guidance. This certificate remains the property of SAI Global and will be returned if non-compliance occurs. To verify this certificate is correct, please refer to the SAI Global Certificate Registration Register. [www.sai-global.com/certificates](http://www.sai-global.com/certificates) and [www.sai-global.com/certificates](http://www.sai-global.com/certificates)









# Table of Contents

## HDD Pullback Swivels

DUB-Lite	4-5
Dub-In	6
DUB-Swivel	6-8
Pin Kits	9
Maxi DUB-Swivel	10-11
Specialty DUB-Swivels	11-12
Swivel Grease	12

---

## Pulling & Support Grips

Wire Grip Swivel	27
Pulling Grips	28-32
Fiber Headboard	32
Support Grips	33-36

---

## Duct Installation

Innerduct Pulling Eyes	44-45
Vibratory Plow Grip	45
Duct Pullers	46-48
Replacement O-Rings	49
Duct Brushes, Test Slug	50
Duct Checkers	51

---

## Cable Pulling Lubricants

Tube-Lube 326	59
Tube-Lube 326 Applicators	60
Tube-Lube 346	61
Lube Spreader	61

---

## Duct Rodders

Deluxe Duct Rodders	73-77
Duct Rodder Accessories	77-80
Rod Counter	80
Wire Mesh Grips	81
Hand Rodder	81
Fiber Optic Cage	81

---

## Overhead Products

Lashers	88-89
Lasher Accessories	89-90
Lashing Wire & Clamps	91
Pin Guard	91

---

## Swivels & Connectors

Clevis Pin	13
Line Swivels	14
Wire & Rope Connectors	15
Breakaway Connectors	16-23
Shackles & Connectors	24-25
Wire Rope Bridle Sling	25

---

## Cable Pulling Eyes

Swivel-Grip	37
Power-Grips	38-39
Cable Pulling Eye Kits	40-41
Multiplex Eyes	42
Mini-Grip	43
Pulling Harness	43

---

## Manhole Tools

Quadrants, Hangers	52-53
Guides	53-54, 56
Sheaves	55
Meter Box Puller	56
Entry Bells	57
Cable Protectors/Separators	57
Manhole Brace	58

---

## Cable Pullers

TUF-Lugger Lite	62-63
Anchors & Accessories	64-69
Meter Box Puller Kits	68
TUF-Lugger	70
TUF-Lugger Add-ons	71
Fiber Cable Puller	72

---

## Line Blowing

Power Blower	82
Blower Add-ons	83
Blowing Projectiles	83-84
Control Valve, Duct Seals	85-86
Spool Frame	87
Tapes & Twine	87

---

## General Information

Index	96
Terms & Conditions	97

---





## DUB-Lite®

Specifically built for the HDD industry, DUB-Lite swivels feature a multiple sealing system which is progressive in design and application. Swivels 00503-X04 to 00503-X15 include a side-mounted grease nipple for easy access without having to remove the clevis pin. Greasing should be done after each use.

The DUB-Lite® swivels utilize angular contact bearings for both pullback and pushback functions. All mechanical components are manufactured from high strength alloy steel and are designed to withstand a straight tensile load of at least 3 times the safe working load. The simplicity of this swivel allows field rebuilding and a rebuild kit comprised of bearings and seals is available.

The DCD Clevis Pin is specifically designed, machined and heat treated to provide the required strength and stability of the clevis. The clevis pins are hardened steel and are available as replacement kits. These clevis pins must not be replaced with simple hexagon bolts.

## Type 2 - Clevis/Clevis

The clevis by clevis style of swivel is the most common type and is the best for distributing side loads applied on the swivel due to its ability to pivot at either end. It does not allow the operator to push back without proper care and attention or the swivel may fold back on itself. Before rotation is recommenced, the line must be pulled straight or damage may occur to the swivel, as well as potential harm to nearby operators.

DCD recommends that some type of restrictor be used to prevent the swivel from pivoting at the front or reamer end. For swivels 00503-202 to 00503-215, the clevis is deeper at the leading end to allow the fool-proof design of a lug that would prevent more than minimal movement of the swivel away from the axis of rotation and also ensures the swivel is pulled in the right direction.

It is our recommendation to always select a swivel larger than the machine capacity. For more information, see bottom of page .

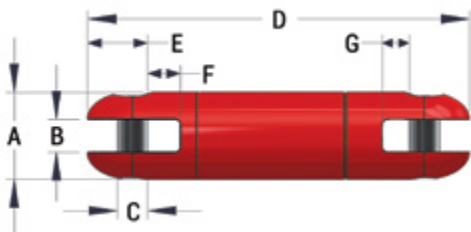

00503-202 to 00503-215

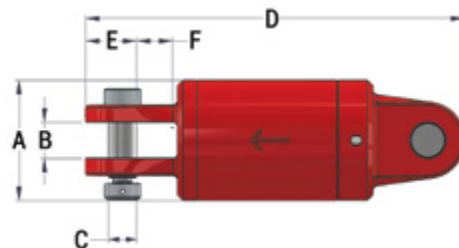

00503-220 to 00503-245

Part No.	3:1 Safe Working Load	Ultimate Load	A	B	C	D	E	F	G	Weight	Clevis Pin Kit	Rebuild Kit
00503-202	5,000 lb	15,000 lb	1-1/4"	1/2"	13/32"	4-31/32"	3/4"	1/2"	9/16"	1.08 lb	00020-HEX	-
00503-204	8,500 lb	25,500 lb	2"	3/4"	11/16"	7-11/16"	1-3/8"	5/8"	3/4"	4.40 lb	00035-HEX	00503-K04
00503-205	10,000 lb	30,000 lb	2-1/4"	7/8"	3/4"	9-5/8"	1-1/2"	3/4"	7/8"	6.90 lb	00037-HEX	00503-K05
00503-208	15,000 lb	45,000 lb	2-1/2"	1"	7/8"	10-9/32"	1-3/4"	7/8"	1"	10.0 lb	00040-HEX	00503-K08
00503-210	20,000 lb	60,000 lb	2-1/2"	1"	7/8"	11-7/8"	1-3/4"	7/8"	1"	10.7 lb	00040-HEX	00503-K10
00503-215	30,000 lb	90,000 lb	3"	1-5/16"	1-1/8"	14"	2-1/4"	1-1/8"	1-1/4"	17.2 lb	00045-HEX	00503-K15
00503-220	40,000 lb	120,000 lb	4-3/4"	1-3/4"	1-1/8"	16-1/2"	2-1/16"	1-7/16"	-	49.0 lb	00508-015	00503-K20
00503-230	60,000 lb	180,000 lb	5-3/4"	1-3/4"	1-3/8"	18-1/4"	2-1/2"	1-7/16"	-	76.0 lb	00508-020	00503-K30
00503-245	90,000 lb	270,000 lb	6"	1-3/4"	1-3/8"	19-3/8"	2-1/2"	1-7/16"	-	88.0 lb	00508-020	00503-K45



## Type 3 - Flange/Lug

This style is specifically designed for directional drilling applications. It is intended to be mounted internally into a back reamer using a bolt flange. This type of swivel permits rotation of the drill pipe while protecting the utility from twisting.

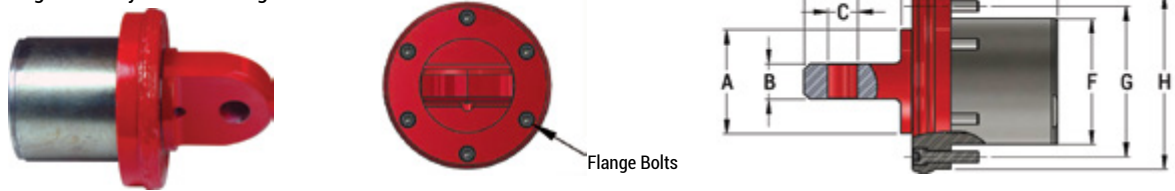

Part No.	3:1 Safe Working Load	Ultimate Load	A	B	C	D	E	F	G	H	J	K	L	M	Flange Bolts	Weight
00503-330	60,000 lb	180,000 lb	4-3/4"	1-5/8"	1-3/8"	2-15/32"	2"	5-3/4"	6-7/8"	8"	11-19/32"	6-3/4"	4-7/8"	1-1/4"	6 x 1/2" UNC	66.0 lb

## Type 6 - Flange/Clevis

This style is intended to be mounted internally into a back reamer using a bolt flange. Hard surfacing is applied around the perimeter for extra durability. This type of swivel permits pushback without any fold-back possibility.

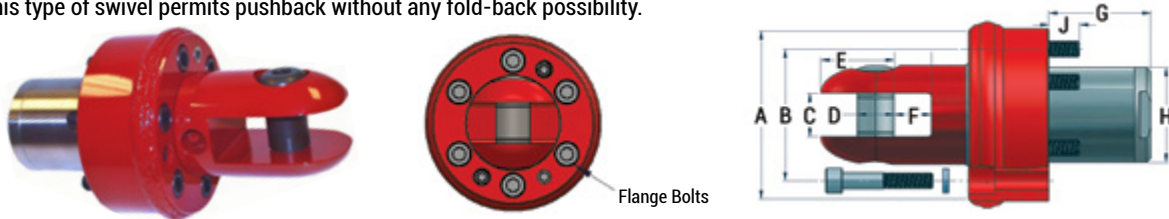

Part No.	3:1 Safe Working Load	Ultimate Load	A	B	C	D	E	F	G	H	J	Flange Bolts	Weight
00503-610	20,000 lb	60,000 lb	5-1/4"	4"	1"	7/8"	1-3/4"	7/8"	2-9/16"	2-7/8"	1"	6 x 1/2" UNC	18.0 lb
00503-615	30,000 lb	90,000 lb	5-1/4"	4"	1-5/16"	1-1/8"	2-1/4"	1-1/8"	3-1/8"	2-7/8"	1"	6 x 1/2" UNC	20.0 lb
00503-620	40,000 lb	120,000 lb	8"	6-7/8"	1-3/4"	1-1/8"	2-1/16"	2"	4"	4-3/4"	1-1/4"	6 x 1/2" UNC	51.0 lb
00503-630	60,000 lb	180,000 lb	8"	6-7/8"	1-3/4"	1-1/8"	2-1/16"	2"	4-7/8"	5-3/4"	1-1/4"	6 x 1/2" UNC	66.0 lb

## Type 7 - Clevis/Pin

Type 7 swivels offer a pin connection to the reamer or hole-opener ahead of the swivel. There are several different types and sizes of threaded connections (see chart for details). The rigid connection allows more straightforward pushback, but also places a greater side load on the swivel.

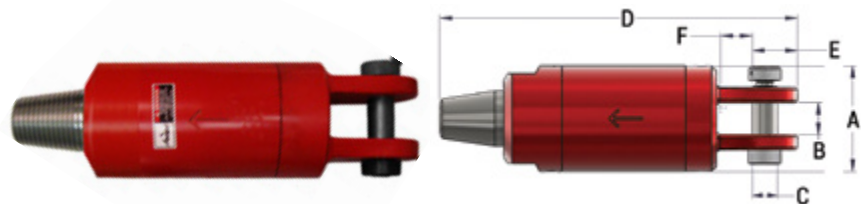

Part No.	3:1 Safe Working Load	Ultimate Load	Male Pin Thread	A	B	C	D	E	F	Weight
00503-705-21M	10,000 lb	30,000 lb	2" IF API	2-1/2"	7/8"	3/4"	11-5/16"	1-1/2"	3/4"	9.9 lb
00503-710-21M	20,000 lb	60,000 lb	2" IF API	2-1/2"	1"	7/8"	12-11/16"	1-3/4"	7/8"	12.6 lb
00503-710-23M	20,000 lb	60,000 lb	2-3/8" Reg API	3-1/4"	1"	7/8"	13-7/8"	1-3/4"	7/8"	13.0 lb
00503-715-23M	30,000 lb	90,000 lb	2-3/8" Reg API	3-1/4"	1-5/16"	1-1/8"	15"	2-1/4"	1-1/8"	20.8 lb
00503-720-23M	40,000 lb	120,000 lb	2-3/8" Reg API	4-3/4"	1-3/4"	1-1/8"	17-1/2"	2-1/16"	1-7/16"	55.0 lb
00503-730-27M	60,000 lb	180,000 lb	2-7/8" IF API	5-3/4"	1-3/4"	1-3/8"	19-9/16"	2-1/2"	1-7/16"	88.0 lb
00503-745-27M	90,000 lb	270,000 lb	2-7/8" IF API	6"	1-3/4"	1-3/8"	20-3/4"	2-1/2"	1-7/16"	100.0 lb
00503-715V*	30,000 lb	90,000 lb	2.06-8 Vermeer® Starter Rod	3"	1-5/16"	1-1/8"	15-3/8"	2-1/4"	1-1/8"	19.4 lb

\* Vermeer® is a registered trademark and the property of Vermeer Manufacturing Company.



## DUB-In™

This series of built-in swivels is designed to act as a replacement for the original swivel fitted to reamers manufactured by the leading OEMs.

Several OEMs offer reamers with a pocket to mount a bolt flange style swivel; others offer reamers with a female threaded pocket to mount a screw in swivel which is then secured with a hexagon collar. However, swivels are not their leading product, directional drilling machines are. DCD Design & Manufacturing is in the business of designing and building swivels and the products shown on this page all offer substantial improvements over the OEM product.

Features include:

- Multiple-stage sealing system.
- Side mounted grease nipple for thorough greasing.
- Hard weld surround on flange to prevent wear at the head of the securing bolts.
- Angular contact bearings provide durability and excellent axial capacity. They have been maximized within the design of the reamer.
- Clevis connection with high strength, hardened and replaceable clevis pins. No longer a need for shackles to complete the connection.
- Completely self contained unit with jacking screws for easy removal.
- Both types feature a water port with plug.
- No modifications necessary to the reamer – simply use these as replacement parts.

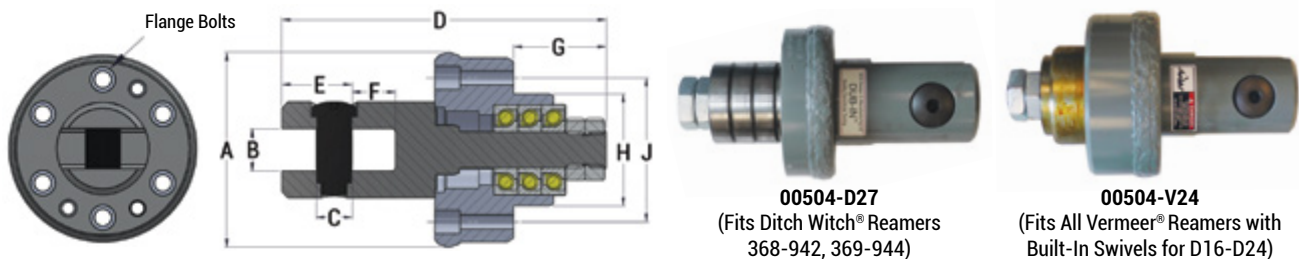

Part No.	3:1 Safe Working Load	Ultimate Load	A	B	C	D	E	F	G	H	J	Flange Bolts	Weight
00504-D27*	27,000 lb	81,000 lb	5-7/8"	1-1/4"	1-1/8"	10-1/8"	2-1/8"	1-3/8"	3-7/8"	2.835"	3-17/32"	6 x 3/8" UNC	17 lb
00504-V24**	24,000 lb	72,000 lb	6-1/4"	1-5/16"	1-1/8"	10-1/8"	2-1/8"	1-3/8"	2-15/16"	3.500"	4-1/2"	6 x 1/2" UNC	24 lb

\* Ditch Witch® is a registered trademark and the property of The Charles Machine Works Co. Inc.

\*\* Vermeer® is a registered trademark and the property of Vermeer Manufacturing Company.

## DUB-Swivel®

These pullback swivels are designed specifically for horizontal directional drilling applications and after more than 20 years, they have proven capable of the challenge. When DCD Design patented the "Harsh Environment Swivel" in 1996, it was ahead of its time. The most important feature of the DUB-Swivel® design was the sealing system: multiple stages became progressively finer to exclude sand and other coarse particles that can easily destroy a seal.

DCD DUB-Swivels® start with a gap seal to keep out larger particles, then a mechanical seal with lapped steel rings rotating against each other. This seal was designed for abrasive environments: military tank drivetrains, bulldozers, and cement mixers. For the final stage of protection, a lip seal is used directly in front of the bearings.

In addition to the sealing system, these swivels offer an easily accessible lubrication system complete with relief valve. A high-quality grease formulation fills the bearing cavity, providing an immersed physical barrier to the rotating bearing elements. Regular maintenance – topping up the grease in small quantities – will ensure a full charge of clean lubricant is always protecting the bearings. Units are also rebuildable.

The bearing arrangement in the DUB-Swivels® is another key to their durability. DUB-Swivels® use back-to-back tapered roller bearings in the smaller sizes up to and including 20 ton capacity. The design life-span of DUB-Swivel® bearings are in excess of 700 hours. This life-span is based on proper usage of the swivel - severe side or shock loads as well as maintenance and care will affect these expectations. Close attention must be paid to the product information sheets that accompany each swivel shipped.

It is our recommendation to always select a swivel larger than the machine capacity. It is usually more cost effective when this is done and, if the product is used carefully, life-span in excess of 3,000 hours have been recorded.

All DUB-Swivel® mechanical components are designed to withstand a straight tensile load of 5 times the safe working limit. DUB-Swivels® with a 20 ton capacity and larger are built with individually assigned serial numbers and complete material traceability for every component.

## Type 1 - API Box/Clevis

Type 1 swivels offer an API box connection at the leading end and a clevis connection at the trailing end. The rigid connection allows more straight forward pushback, but it also places a greater side load on the swivel.



Part No.	5:1 Safe Working Load	Ultimate Load	Box Thread	A	B	C	D	E	F	Weight	Pin Kit
00508-115C	30,000 lb	150,000 lb	2-3/8" IF API	4-3/4"	1-3/4"	1-1/8"	17-7/8"	2-7/16"	1-9/16"	61 lb	00508-P015
00508-120C	40,000 lb	200,000 lb	2-3/8" IF API	5-3/4"	1-3/4"	1-3/8"	19-3/8"	2-7/16"	1-9/16"	79 lb	00508-P020
00508-120D	40,000 lb	200,000 lb	2-7/8" IF API	5-3/4"	1-3/4"	1-3/8"	19-1/2"	2-7/16"	1-9/16"	90 lb	00508-P020
00508-130D	60,000 lb	300,000 lb	2-7/8" IF API	6"	1-3/4"	1-3/8"	19-1/2"	2-7/16"	1-9/16"	94 lb	00508-P020
00508-130E	60,000 lb	300,000 lb	3-1/2" IF API	6"	1-3/4"	1-3/8"	20"	2-7/16"	1-9/16"	90 lb	00508-P020
00508-140E	80,000 lb	400,000 lb	3-1/2" IF API	6-1/2"	2-1/8"	1-3/4"	24-7/8"	3-1/4"	2"	144 lb	00508-P040
00508-140F	80,000 lb	400,000 lb	4-1/2" IF API	6-1/2"	2-1/8"	1-3/4"	26"	3-1/4"	2"	168 lb	00508-P040
00508-160F	120,000 lb	600,000 lb	4-1/2" IF API	7-1/2"	2-3/4"	2-1/8"	30-7/8"	3-9/16"	2-3/16"	257 lb	00508-P060
00508-180F	160,000 lb	800,000 lb	4-1/2" IF API	9"	3-1/4"	2-1/2"	32-5/8"	4-13/16"	2-13/16"	368 lb	00508-P080

US Patent # 5,529,421  
 Canadian Patent # 2,109,041  
 Maxi DUB-Swivel is a Registered Trade Mark

## Type 2 - Clevis/Clevis

Type 2 swivels offer a clevis connection at both ends with hardened, lockable clevis pins. This style of swivel is the most common type and is the best for distributing side loads applied on the swivel due to its ability to pivot at either end. It does not allow the operator to push back without proper care and attention or the swivel may fold back on itself. When rotation is recommended, the line must be pulled straight or damage may occur to the clevis ends.

Because the DCD Clevis Pin is a precision machined product specifically designed to fit the clevis, field substitution with any other pins is not recommended. Doing so may cause serious danger to operators and equipment and will immediately void any warranty or liability for the product.

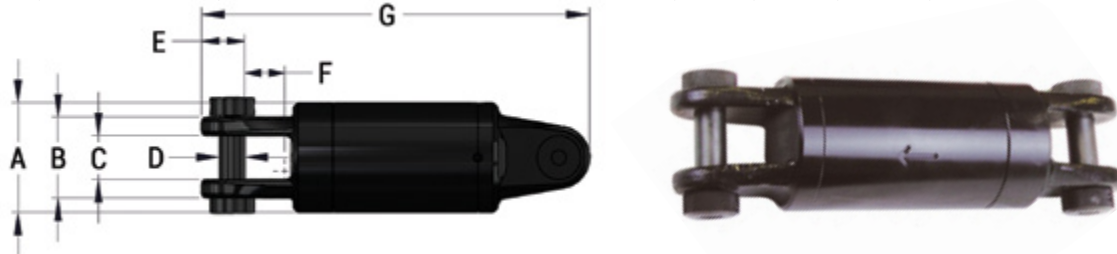

Part No.	5:1 Safe Working Load	Ultimate Load	A	B	C	D	E	F	G	Weight	Clevis Pin Kit
00508-202	5,000 lb	25,000 lb	2"	2"	1"	11/16"	1-3/16"	13/16"	7-1/2"	3.8 lb	00508-002
00508-205	10,000 lb	50,000 lb	3-1/8"	2-1/4"	1-1/4"	3/4"	1-1/4"	1-1/4"	11-1/16"	15 lb	00508-005
00508-210	20,000 lb	100,000 lb	3-3/4"	2-3/4"	1-1/2"	1"	1-5/8"	1-1/16"	13-9/16"	27 lb	00508-010
00508-215	30,000 lb	150,000 lb	4-3/4"	3-1/4"	1-3/4"	1-1/8"	2-1/16"	1-7/16"	17-3/8"	57 lb	00508-015
00508-220	40,000 lb	200,000 lb	5-3/4"	3-1/2"	1-3/4"	1-3/8"	2-1/2"	1-9/16"	18-1/2"	83 lb	00508-020
00508-230	60,000 lb	300,000 lb	6"	3-1/2"	1-3/4"	1-3/8"	2-1/2"	1-9/16"	18-1/2"	85 lb	00508-020
00508-240	80,000 lb	400,000 lb	6-1/2"	4-5/8"	2-1/8"	1-3/4"	3-1/4"	2-1/4"	24-11/16"	150 lb	00508-040
00508-250	100,000 lb	500,000 lb	7-1/2"	5-1/2"	2-3/4"	2-1/8"	3-5/8"	2-5/8"	26-3/8"	230 lb	00508-060
00508-260	120,000 lb	600,000 lb	7-1/2"	5-1/2"	2-3/4"	2-1/8"	3-9/16"	2-1/4"	28-1/2"	250 lb	00508-060
00508-280	160,000 lb	800,000 lb	9"	6"	3-1/4"	2-1/2"	4-13/16"	2-7/8"	33-7/8"	380 lb	00508-080



## Type 6 - Clevis/Flange (Stub-E-DUB™)

Type 6 swivels are specially designed to fit inside custom built reamers. There are several manufacturers making these specific reamers. They have a mounting flange allowing assembly into the reamer and thereby reducing the gap back to the utility being installed. These swivels are totally self contained and greasable.

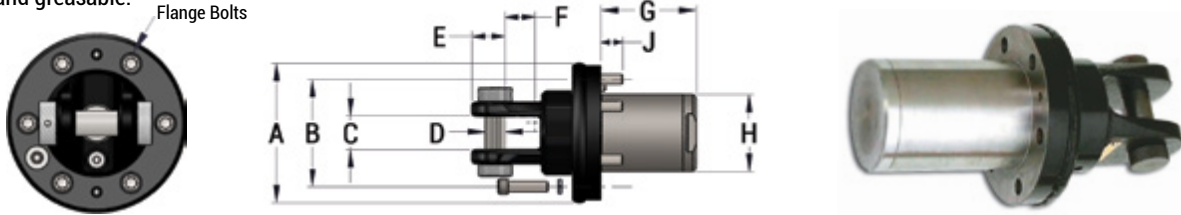

Part No.	5:1 Safe Working Load	Ultimate Load	A	B	C	D	E	F	G	H	J	Flange Bolts	Weight
00508-605	10,000 lb	50,000 lb	5"	4"	1-1/4"	3/4"	1-1/4"	1"	3-1/2"	2-7/8"	7/8"	6 x 3/8 UNC	15 lb
00508-610	20,000 lb	100,000 lb	6-1/8"	4-7/8"	1-1/2"	1"	1-9/16"	1-1/16"	4-3/16"	3-5/8"	1-1/8"	6 x 1/2 UNC	29 lb
00508-615	30,000 lb	150,000 lb	7-1/4"	5-7/8"	1-3/4"	1-1/8"	2"	1-9/16"	5-1/4"	4-3/8"	1-3/16"	6 x 5/8 UNC	51 lb
00508-620	40,000 lb	200,000 lb	9-1/2"	7-3/4"	1-3/4"	1-3/8"	2-7/16"	1-9/16"	6-1/16"	6"	1-1/16"	8 x 3/4 UNC	57 lb
00508-630	60,000 lb	300,000 lb	9-1/2"	7-3/4"	1-3/4"	1-3/8"	2-7/16"	1-9/16"	6-1/16"	6"	1-1/16"	8 x 3/4 UNC	83 lb
00508-640	80,000 lb	400,000 lb	9-1/2"	7-3/4"	2-1/8"	1-3/8"	3-1/4"	2"	8"	6"	1-1/16"	8 x 3/4 UNC	157 lb
00508-660*	120,000 lb	600,000 lb	10-3/4"	9"	2-3/4"	2-1/8"	3-9/16"	2-3/16"	9-5/8"	7-1/2"	1-3/8"	8 x 3/4 UNC	237 lb

\* Custom order only.

## Type 7 - Clevis/Pin

Type 7 swivels offer a pin connection to the reamer or hole-opener ahead of the swivel. There are several different types and sizes of threaded connections, see the chart for details. The rigid connection allows more straightforward pushback, but it also places a greater side load on the swivel.



Part No.	5:1 Safe Working Load	Ultimate Load	Male Pin Thread	A	B	C	D	E	F	Weight	Pin Kit
00508-710-23M	20,000 lb	100,000 lb	2-3/8" Reg API	3-3/4"	1-1/2"	1"	14-5/8"	1-9/16"	1-1/16"	29 lb	00508-P010
00508-715-23M	30,000 lb	150,000 lb	2-3/8" Reg API	4-3/4"	1-3/4"	1-1/8"	17-1/16"	2"	1-9/16"	55 lb	00508-P015
00508-715-27M	30,000 lb	150,000 lb	2-7/8" IF API	4-3/4"	1-3/4"	1-1/8"	17-3/4"	2"	1-9/16"	76 lb	00508-P015
00508-720-27M	40,000 lb	200,000 lb	2-7/8" IF API	5-3/4"	1-3/4"	1-3/8"	19-1/8"	2-7/16"	1-9/16"	84 lb	00508-P020
00508-730-27M	60,000 lb	300,000 lb	2-7/8" IF API	6"	1-3/4"	1-3/8"	19-1/8"	2-7/16"	1-9/16"	87 lb	00508-P020
00508-740-27M	80,000 lb	400,000 lb	2-7/8" IF API	6-1/2"	2-1/8"	1-3/4"	23-11/16"	3-1/4"	2"	142 lb	00508-P040
00508-710V	20,000 lb	100,000 lb	2.06-8" Starter Rod	3-3/4"	1-1/2"	1"	16"	1-9/16"	1-1/16"	29 lb	00508-P010
00508-715V	30,000 lb	150,000 lb	2.06-8" Starter Rod	4-3/4"	1-3/4"	1-1/8"	18-1/2"	2"	1-9/16"	55 lb	00508-P015

US Patent # 5,529,421  
 Canadian Patent # 2,109,041  
 Maxi DUB-Swivel is a Registered Trade Mark

## The Lifespan of a Swivel

At the safe working load and under standard conditions, a swivel's bearing will last for one million revolutions. At one-half the safe working load, it will last significantly longer: eight million revolutions. Both these calculations presume the swivel and grease are not compromised.

In short, the harder you work a swivel, the shorter the lifespan – and the relationship is not linear! The load on the swivel is one factor. The care and maintenance you provide for the equipment is another major factor.

To last for eight million revolutions, the swivel and its bearing will need lubrication at regular intervals. Since the frequency of maintenance will directly affect the level of reliability, we recommend lubrication after every pullback to keep the grease in the best possible condition.

## Pin Kits for DUB-Lite®, DUB-In™, & DUB-Swivels®

There are three different pin kits available for the various types and sizes of our DUB line of swivels.

Pin Kit No.	Allen Key Size	Type 2	Type 6	Type 7	Other
00035-HEX	00101-375 (3/8")	00503-204	-	-	-
00037-HEX	00101-375 (3/8")	00503-205	-	00503-705-21M	-
00040-HEX	00101-375 (3/8")	00503-208 00503-210	00503-610	00503-710-21M 00503-710-23M	-
00045-HEX	00101-375 (3/8")	00503-215	00503-615	00503-715-23M 00503-715V	00504-D27 00504-V24



Pin Kit No.	Allen Key Size	Type 1	Type 6	Type 7
00508-P005	00101-156 (5/32")	-	00508-605	-
00508-P010	00101-187 (3/16")	-	00508-610	-
00508-P015	00101-187 (3/16")	00508-115C	00508-615	-
00508-P020	00101-187 (3/16")	00508-120C 00508-120D 00508-130D 00508-130E	00508-620 00508-630	00503-720-23M 00508-720-27M 00503-730-23M 00508-730-27M 00503-745-23M 00503-745-27M
00508-P040	00101-250 (1/4")	00508-140E 00508-140F	00508-640	00508-720-27M
00508-P060	00101-250 (1/4")	00508-160F	00508-660	-
00508-P080	00101-312 (5/16")	00508-180F	-	-
00508-P110	00101-312 (5/16")	00508-1110	-	-
00508-P165	00101-312 (5/16")	00508-1165	-	-
00508-P220	00101-375 (3/8")	00508-1220	-	-
00508-P275	00101-375 (3/8")	00508-1275	-	-
00508-P350	00101-500 (1/2")	00508-1350 00508-1351	-	-
00508-P500	00101-625 (5/8")	00508-1500 00508-1501	-	00508-7500
00508-P700	00101-625 (5/8")	00508-1700	-	00508-7700



Pin Kit No.	Allen Key Size	Type 2
00508-002	00101-375 (3/8")	00508-202
00508-005	00101-156 (5/32")	00508-205
00508-010	00101-187 (3/16")	00508-210
00508-015	00101-187 (3/16")	00503-220 00508-215
00508-020	00101-187 (3/16")	00503-230 00503-245 00508-220 00508-230
00508-040	00101-250 (1/4")	00508-240
00508-060	00101-250 (1/4")	00508-260
00508-080	00101-312 (5/16")	00508-280





## Maxi DUB-Swivel®

DCD's Maxi DUB-Swivel® is essentially a scaled-up version of our DUB-Swivel, utilizing the same sealing system in which multiple stages become progressively finer to exclude coarse particles that could otherwise easily destroy the seal. This design starts with a gap seal to keep out larger particles, followed by a mechanical seal with lapped steel rings that rotate against each other. This type of seal is ideal for abrasive environments, such as cement mixers, military tank drivetrains, and bulldozers. A lip seal used directly in front of the bearings then provides the final stage of protection.

In addition to the sealing system, Maxi DUB-Swivels offer an easily accessible lubrication system complete with relief valve. The bearing cavity is filled with a high-quality grease formulation, providing an immersed physical barrier to the rotating bearing elements. Regular maintenance, such as topping up the grease in small quantities, will ensure a full charge of clean lubricant is always protecting the bearings.

The Maxi DUB-Swivels® use a combination of bearings to provide tensile and side load support. This arrangement was pioneered by DCD Design, proven in service, and more recently, duplicated by our competitors.

The Maxi DUB-Swivel® bearings are designed to provide a life span in excess of 700 hours. This life span is based on proper usage of the swivel – severe side or shock loads as well as maintenance and care will affect these expectations.

All mechanical components are designed to withstand a tensile load of 3-1/2 times the safe working limit typically.

All Maxi DUB-Swivels® are built with individually assigned serial numbers and complete material traceability for every component.

For information on replacement Pin Kits, please see page 7. Seal kits are also available upon request.



## Type 1 - API Box / Clevis for Maxi Rigs

The increased range of Maxi-Rig swivels is designed to better fit the capacities of the most common rig manufacturers. Type 1 swivels offer an API box connection at the leading end and a clevis connection at the trailing end. The rigid connection allows more straight forward pushback, but it also places a greater side load on the swivel.

This special series is designed with service in mind. The seal cover is removable and all seals can be replaced in the field without need for major disassembly. Factory service can be scheduled to keep the Maxi-DUB Swivel® running smoothly; this preventative maintenance will keep the swivel operating longer.

Note: Additional thread options are available upon request.

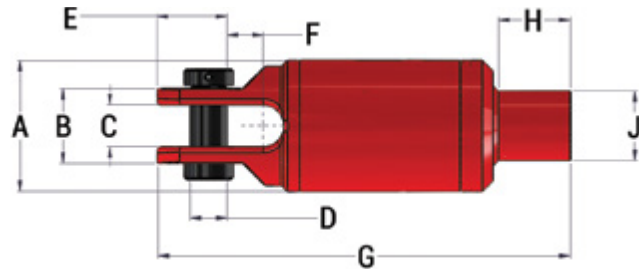

Part No.	Safe Working Limit	Ultimate Load	Box Thread	A	B	C	D	E	F	G	H	J	Weight
<b>00508-1110*</b>	110 ton 100 tonne	400 ton 360 tonne	4-1/2" IF API	10-3/4" 273 mm	6" 152 mm	3-1/4" 83 mm	2-1/2" 64 mm	4-3/4" 121 mm	2-7/8" 72 mm	35" 889 mm	7-1/2" 190 mm	6-5/8" 169 mm	420 lb 190 kg
<b>00508-1165*</b>	165 ton 150 tonne	600 ton 540 tonne	4-1/2" IF API	10-3/4" 273 mm	6-1/2" 165 mm	3-1/2" 89 mm	3" 76 mm	5-1/2" 140 mm	3" 76 mm	38" 965 mm	7-1/2" 190 mm	6-5/8" 169 mm	570 lb 258 kg
<b>00508-1220*</b>	220 ton 200 tonne	750 ton 680 tonne	6-5/8" Reg API	12-1/2" 318 mm	7" 178 mm	4" 102 mm	3-1/2" 89 mm	6-1/2" 165 mm	4" 102 mm	41-7/8" 1,064 mm	8-1/4" 209 mm	7-3/4" 196 mm	846 lb 383 kg
<b>00508-1275**</b>	275 ton 250 tonne	1,000 ton 907 tonne	6-5/8" FH API	14-1/2" 368 mm	8-9/16" 217 mm	4-1/2" 114 mm	4" 102 mm	7" 178 mm	3-1/2" 89 mm	42-7/16" 1,078 mm	8-7/16" 214 mm	8-1/2" 216 mm	1,500 lb 681 kg
<b>00508-1351</b>	350 ton 320 tonne	1,250 ton 1,130 tonne	6-5/8" FH API	16" 406 mm	9" 229 mm	5" 127 mm	4-1/2" 114 mm	8-1/2" 216 mm	4-1/2" 114 mm	50-11/16" 1,287 mm	8-7/8" 225 mm	8-7/8" 225 mm	1,690 lb 770 kg
<b>00508-1501</b>	500 ton 450 tonne	1,750 ton 1,580 tonne	6-5/8" FH API	23" 584 mm	10-1/2" 267 mm	5-1/2" 140 mm	5-1/2" 140 mm	9-3/4" 248 mm	5-1/4" 133 mm	55-9/16" 1,411 mm	8-7/8" 225 mm	8-7/8" 225 mm	2,540 lb 1,150 kg
<b>00508-1700**</b>	700 ton 640 tonne	2,500 ton 2,270 tonne	7-5/8" Reg API	23" 584 mm	12-1/2" 318 mm	6-1/2" 165 mm	6-1/2" 165 mm	11-1/2" 292 mm	5-1/2" 140 mm	65-7/16" 1,663 mm	9-1/2" 241 mm	9-1/4" 234 mm	4,120 lb 1,880 kg

\* Also available in a high pressure version; made to order.

\*\* Sizes made to order.

US Patent # 5,529,421  
Canadian Patent # 2,109,041  
Maxi DUB-Swivel is a Registered Trade Mark

## Type 7 - API Pin / Clevis for Maxi Rigs

Type 7 Maxi-DUB Swivels® with an API pin connection (to the reamer or hole-opener ahead of the swivel) are a special-order option. The specifications are identical to the standard Type 1 Maxi-DUB Swivels®. Custom threads are available; contact Customer Service for more details.

Note: Type 7 Maxi DUB-Swivels are made to order.

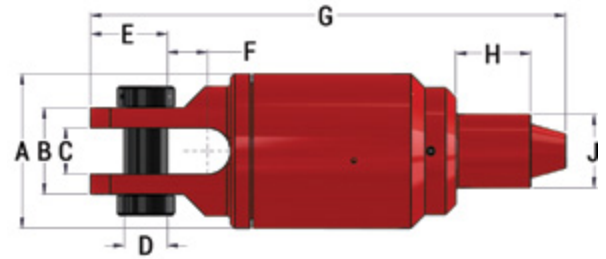

Part No.	Safe Working Limit	Ultimate Load	Pin Thread	A	B	C	D	E	F	G	H	J	Weight
<b>00508-7500</b>	500 ton 450 tonne	1,750 ton 1,580 tonne	6-5/8" FH API	19-1/2" 495 mm	10-1/2" 267 mm	5-1/2" 140 mm	5-1/2" 140 mm	9-3/4" 248 mm	5-1/4" 133 mm	64-3/4" 1,645 mm	12-1/8" 308 mm	9-1/4" 235 mm	2,700 lb 1,230 kg
<b>00508-7700</b>	700 ton 640 tonne	2,500 ton 2,270 tonne	6-5/8" FH API	23" 584 mm	12-1/2" 318 mm	6-1/2" 165 mm	6-1/2" 165 mm	11-1/2" 292 mm	5-1/2" 140 mm	72-11/16" 1,847 mm	12-1/8" 308 mm	9-1/4" 235 mm	4,120 lb 1,880 kg

## Type 8 - API Box / Lug for Maxi Rigs

Special applications call for special solutions: Type 8 Maxi-DUB Swivels® have been built to customer specifications to fit shackle connections. Otherwise specifications are identical to the standard Type 1 Maxi-DUB Swivels®; contact Customer Service for more details.

Note: Type 8 Maxi DUB-Swivels are made to order.

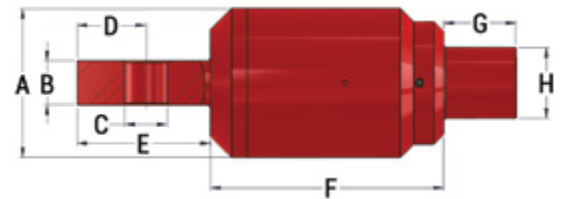

Part No.	Safe Working Limit	Ultimate Load	Box Thread	A	B	C	D	E	F	G	H	Weight
<b>00508-8500</b>	500 lb 450 tonne	1,750 ton 1,580 tonne	7-5/8" REG API	19-1/2" 495 mm	5-3/4" 146 mm	5-1/2" 140 mm	9" 229 mm	17-7/16" 444 mm	57-9/16" 1,461 mm	9-1/4" 234 mm	9-1/4" 234 mm	2,700 lb 1,230 kg
<b>00508-8501</b>	500 ton 450 tonne	1,750 ton 1,580 tonne	7-5/8" REG API	19-1/2" 495 mm	6-7/8" 175 mm	5-7/16" 138 mm	9" 229 mm	16-3/16" 412 mm	56-5/16" 1,430 mm	9-1/4" 234 mm	9-1/4" 234 mm	2,700 lb 1,230 kg

## Specialty Swivels

The engineers at DCD have designed and developed several new DUB-Swivels, ranging from an auger boring version to what we've termed Clutch Swivels, which have locking sleeves that can allow free rotation and the transmission of torque up to 27,500 ft-lb. Some of the Clutch Swivels also have a through-bore feature that allows drilling fluid to pass through the swivel at pressures up to 1,500 psi. These brand new products add a versatile touch to our DUB-Swivel line.

## Type 9 DUB-Swivel® (Hex Auger Boring)

The 00508-940 Type 9 DUB-Swivel® is an auger boring swivel, used in the guided auger boring process and installed in compression between the pilot rods and auger casing to prevent the rods from rotating as they enter the pit. The unit has a maximum compression safe working load of 80,000 lb (5:1), maximum tension of 20,000 lb, a maximum rotation speed of 90 RPM, and external fluid pressure limit of 1,500 psi. Each end of the swivel is designed with a 3" female hex.

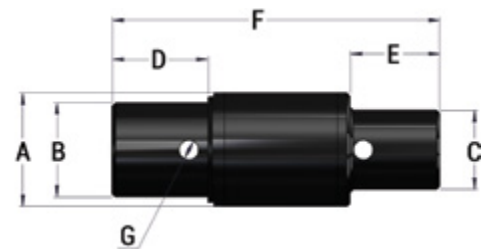

Part No.	Safe Working Limit (Compression)	Ultimate Load (Compression)	Maximum Rotational Speed	Box Thread	A	B	C	D	E	F	G	Weight
<b>00508-940</b>	80,000 lb 356 kN	400,000 lb 1,779 kN	90 RPM	3-1/2" Custom	6-15/32" 164 mm	5-3/8" 137 mm	4-1/2" 114 mm	5-15/32" 139 mm	5-1/8" 130 mm	18-11/16" 475 mm	1-1/8" 29 mm	96 lb 44 kg



# HDD Pullback Swivels

## Clutch DUB-Swivel®

This DUB-Swivel has the same 40,000 lb safe working load as its standard 00508-120D version, but unlike that version, the 00508-120L has a pin connection at the leading end, a box connection at the trailing end, a locking sleeve, and a 1-1/8" bore through the swivel. The locking sleeve can be secured in or out of position, allowing free rotation or the transfer of torque up to 2,000 ft-lb and a maximum inner bore fluid pressure of 300 psi to allow the passage of drilling fluid.

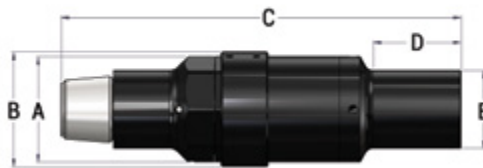

Part No.	Safe Working Limit	Ultimate Load	Maximum Locking Torque	Drilling Fluid Pressure Rating	Box Thread	Pin Thread	A	B	C	D	E	Net Weight
00508-120L	40,000 lb 178 kN	200,000 lb 890 kN	2,000 ft-lb 2,712 Nm	300 psi 2.068 MPa	3-1/2" Custom	3-1/2" Custom	5-3/4" 146 mm	6-1/2" 165 mm	18-15/16" 481 mm	3-7/8" 98 mm	3-3/4" 95 mm	96 lb 44 kg
00508-180L	160,000 lb 712 kN	800,000 lb 3,560 kN	32,000 ft-lb 43,386 Nm	580 psi 3.999 MPa	4-1/2" IF API	4-1/2" IF API	8-31/32" 228 mm	9-3/4" 248 mm	34-1/8" 867 mm	7-1/2" 191 mm	6-5/8" 168 mm	368 lb 167 kg

## Clutch Maxi DUB-Swivel®

This is a locking version of our regular 110T Maxi DUB-Swivel®. Like other locking swivels, the sleeve can be secured in or out of its locked position, allowing free rotation or the transmission of torque up to 27,500 ft-lb. The unit comes standard with a 4-1/2" IF Box connection on each end.

The locking Flow-Thru Swivel is a 220T Maxi DUB-Swivel® specifically intended for coupling with the drill string. It is designed with a 6-5/8" API connection on each end, a locking sleeve, and a clear 3" bore through the center of the swivel. The swivel locking sleeve can be unbolted to allow rotation or bolted to transmit up to 180,000 ft-lb of torque. The locking sleeve can be engaged or disengaged without removing the swivel from the drill string. The thru-bore will allow the passage of drilling fluid through the swivel at pressures up to 1500 psi.

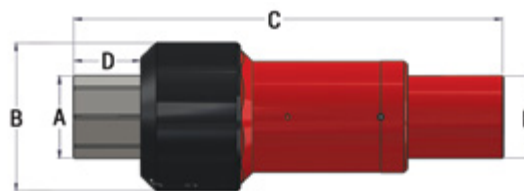

Part No.	Safe Working Limit	Safe Working Limit (Compression)	Ultimate Load (Tension)	Maximum Locking Torque	Box Thread		Internal Pressure Rating	External Pressure Rating	Thru-Bore Dia.	A	B	C	D	E	Net Weight
					Free End	Fixed End									
00508-1110L	110 ton 100 tonne	58 ton 52.6 tonne	400 ton 360 tonne	27,500 ft-lb 37,285 Nm	4-1/2" IF API	4-1/2" IF API	580 psi 4.00 MPa	25 psi 0.172 MPa	2"	6-5/8" 168 mm	12" 305 mm	34-5/8" 880 mm	5-7/16" 138.1 mm	6-21/32" 169 mm	420 lb 190 kg
00508-1165L	165 ton 150 tonne	66 ton 59.8 tonne	600 ton 540 tonne	27,500 ft-lb 37,285 Nm	4-1/2" IF API	4-1/2" IF API	580 psi 4.00 MPa	25 psi 0.172 MPa	2"	6-21/32" 169 mm	12" 305 mm	35-1/2" 902 mm	5-15/32" 138.9 mm	6-21/32" 169 mm	529 lb 240 kg
00508-1220L	220 ton 200 tonne	66 ton 59.8 tonne	750 ton 680 tonne	180,000 ft-lb 244,047 Nm	6-5/8" Reg API	5-1/2" FH API	580 psi 4.00 MPa	25 psi 0.172 MPa	3"	7-3/4" 197 mm	14" 356 mm	37" 940 mm	5-5/8" 142.9 mm	7" 178 mm	766 lb 348 kg

## Swivel Grease

Renolit S<sub>2</sub>TX is a high performance lithium complex grease formulated with highly refined mineral oil and synthetic base stocks. This, along with its state-of-the-art additive system, gives Renolit S<sub>2</sub>TX the utmost in performance and protection of your equipment. Renolit S<sub>2</sub>TX is very resistant to water washout, even in salt water. Its high Timken OK load of 75 lb, along with high dropping point of 525°F, makes it one grease for all applications.

Check for compatibility if using alternate grease types.



Grease Fitting Needle (90030-023)

Part No.	Description	Size	Weight
90030-001	Fuchs Renolit S <sub>2</sub> TX Grease Tube	1 x 411 g	1 lb
90030-003	Fuchs Renolit S <sub>2</sub> TX Grease Drum	1 x 54.4 kg	124 lb
90030-010	Fuchs Renolit S <sub>2</sub> TX Grease Case	10 x 411 g	10 lb
90030-023	Grease Fitting Needle for 00505 Line Swivels	3" Length	0.05 lb

	Compatible	Incompatible	Borderline
DCD Lithium Complex	Aluminum Complex Calcium Stearate Calcium 12 Hydroxy Calcium Complex	Calcium Suffronate Lithium Stearate Lithium 12 Hydroxy Silica Gel	Barium Complex Bentone (Clay) Polyurea Sodium Soap Barium Soap

## Clevis Pin

All clevis pins are manufactured from heat treated 416 stainless steel to provide superior strength and wear. Hardness is between 37-40 Rc.

The DCD Clevis Pin is a shouldered type of pin rather than a simple straight pin without any head. This design greatly improves the strength of the clevis by not allowing side loads to spread the clevis opening.

The clevis and pin are precision machined so that both surfaces contact simultaneously and therefore lock in place when screwed tight. By using the recommended torque, the pin is secured with the corresponding preload, ensuring it won't come loose. Tensile loads are carried by the pin shoulder and transferred to the swivel body, and therefore no tensile load is carried by the thread.

The hardened clevis pin also resists wear much better than conventional clevis pins. During operation there is a constant rubbing between the surface of the clevis pin and the attached item. A hard surface decreases the wear on the pin as well as increasing the strength of the pin.

Finally, the larger diameter of the shoulder will decrease wear on the attached item. If this happened to be a wire rope, a conventional pin would cause that rope to bend in a very tight radius, affecting the life of each strand. The larger DCD pins increase that radius and also increase the life of the wire.

Products 1-1/4" dia. and less are supplied with slotted clevis pins; those greater than 1-1/4" are supplied with hexagon socket clevis pins. This is based on consumer preference. Either slotted or hexagon pins are available for most sizes, but must be requested at time of ordering if not standard.

Because the DCD Clevis Pin is a precision machined product specifically designed to fit the clevis, field substitution with any other pins is not recommended. Doing so may cause serious danger to operators and equipment and will immediately void any warranty or liability for the product.

All Clevis Pin kits contain two pins.

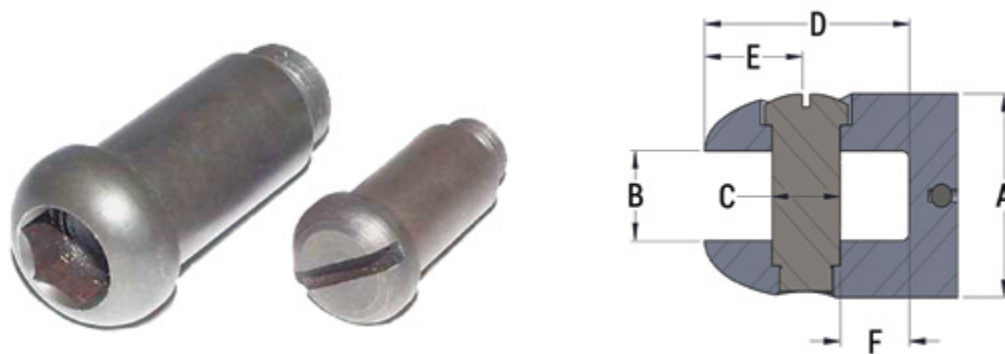

Slotted Part No.	Hexagon Part No.	Hex Key Size	A	B	C	D	E	F	Recommended Torque	Corresponding Preload
00005-SLT*	-	-	5/8"	9/32"	3/16"	11/16"	1/4"	11/32"	1.0 ft-lb	366 lb
00010-SLT*	00010-HEX	7/32"	7/8"	3/8"	5/16"	31/32"	7/16"	3/8"	2.5 ft-lb	600 lb
00015-SLT*	00015-HEX	1/4"	1"	13/32"	3/8"	1-3/32"	1/2"	13/32"	5.4 ft-lb	1,040 lb
00020-SLT*	00020-HEX	1/4"	1-1/4"	17/32"	13/32"	1-9/32"	17/32"	9/16"	6.7 ft-lb	1,280 lb
00025-SLT	00025-HEX*	5/16"	1-3/8"	9/16"	1/2"	1-3/8"	5/8"	1/2"	16.7 ft-lb	2,667 lb
-	00027-HEX*	5/16"	1-1/2"	19/32"	1/2"	1-9/16"	11/16"	5/8"	16.7 ft-lb	2,667 lb
00030-SLT	00030-HEX*	3/8"	1-5/8"	11/16"	5/8"	1-23/32"	3/4"	21/32"	25.0 ft-lb	3,000 lb
00035-SLT	00035-HEX*	3/8"	2"	25/32"	11/16"	2-1/16"	15/16"	25/32"	50.0 ft-lb	5,333 lb
-	00037-HEX*	3/8"	2-1/4"	7/8"	3/4"	2-3/8"	1-1/8"	3/4"	75.0 ft-lb	7,200 lb
-	00040-HEX*	3/8"	2-3/8"	1-1/32"	7/8"	2-25/32"	1-3/16"	1-5/32"	100.0 ft-lb	8,000 lb
-	00045-HEX*	3/8"	3"	1-3/16"	1-1/8"	3-5/8"	1-1/2"	1-9/16"	190.0 ft-lb	13,029 lb
-	00050-HEX*	1/2"	3-3/4"	1-1/2"	1-1/4"	4-1/4"	1-7/8"	1-3/4"	250.0 ft-lb	15,000 lb

\* Standard Clevis Pin type supplied in most products.  
 Note: Marine grade versions are available; made to order.

## Line Swivel

DCD Line Swivels are typically constructed with a thrust bearing for tensile load and a radial bearing for bending load. They combine a high safe working load with a compact design. All sizes incorporate an oil seal and are manufactured from high strength stainless steel.

DCD Locking Line Swivels are typically constructed with a bronze thrust bearing for tensile load and a radial bearing for bending load. The bronze bearing will rotate up to a portion of the safe working load before locking. Once past this point, rotation will only occur when pulling tension is relieved.

Sizes 00505-020 and larger are supplied with a grease point for lubrication. This is particularly useful in overhead applications where high speed rotation is possible.

All sizes of both types are pull tested to verify the 3:1 safety factor.

Sizes 00505-025 and larger are supplied with hexagon clevis pins. Smaller sizes have slotted clevis pins. Under no circumstances should alternate clevis pins be used.

Permanent peen marking is now standard on all line swivels and material traceability for all batches produced.

Note: Line Swivels are not designed to run around bull wheels and severe damage or injury may be incurred if this is done.

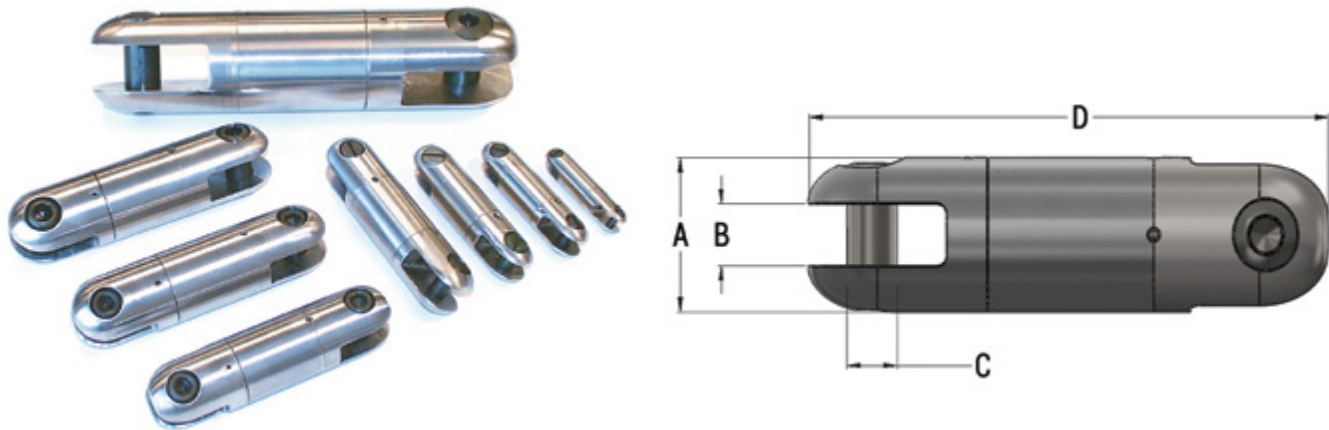

Part No.	Locking Part No.	3:1 Safe Working Load	5:1 Safe Working Load	A	B	C	D	Weight	Replacement Clevis Pin
00505-005	-	750 lb	450 lb	5/8"	9/32"	3/16"	2-1/2"	0.12 lb	00005-SLT
00506-008*	-	1,124 lb	674 lb	25/32"	9/32"	3/16"	3-3/16"	0.19 lb	00005-SLT
00505-010	00505-010A	2,250 lb	1,350 lb	7/8"	3/8"	5/16"	3-3/8"	0.32 lb	00010-SLT, 00010-HEX
00505-015	00505-015A	3,500 lb	2,100 lb	1"	13/32"	3/8"	3-7/8"	0.51 lb	00015-SLT, 00015-HEX
00505-020	00505-020A	5,000 lb	3,000 lb	1-1/4"	17/32"	13/32"	4-3/4"	1.0 lb	00020-SLT, 00020-HEX
00505-025	00505-025A	7,000 lb	4,200 lb	1-3/8"	9/16"	1/2"	5-1/8"	1.4 lb	00025-SLT, 00025-HEX
00505-027	00505-027A	9,000 lb	5,400 lb	1-1/2"	19/32"	1/2"	5-5/8"	1.8 lb	00027-HEX
00505-030	00505-030A	10,000 lb	6,000 lb	1-5/8"	11/16"	5/8"	6"	2.1 lb	00030-SLT, 00030-HEX
00505-035	00505-035A	15,000 lb	9,000 lb	2"	25/32"	11/16"	7"	3.9 lb	00035-SLT, 00035-HEX
00505-040	00505-040A	25,000 lb	15,000 lb	2-3/8"	1-1/32"	7/8"	10-5/16"	8.2 lb	00040-HEX
00505-041**	-	30,000 lb	18,000 lb	2-3/8"	1-1/32"	7/8"	10-5/16"	8.3 lb	00040-HEX
00505-045**	-	50,000 lb	30,000 lb	3"	1-3/16"	1-1/8"	13-3/4"	18 lb	00045-HEX
00505-050**	-	62,500 lb	37,500 lb	3-3/4"	1-1/2"	1-1/4"	15-9/16"	34 lb	00050-HEX

\* This has a metric 3:1 Safe Working Load of 5 kN. Contact Customer Service for other metric equivalents.

\*\* These swivels are made from alloy steel with a black oxide finish; all others are stainless steel.

Note: Marine grade versions are available; made to order.

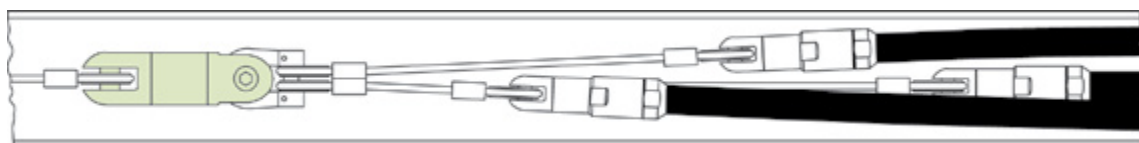



## Can-Link™ Connector

The Can-Link™ Connector is used to connect two items with lugs or wire loop fittings. A common use is to connect a wire mesh grip to the pulling wire. The connectors are manufactured from high strength stainless steel with hardened clevis pins.

The two smaller sizes have slotted clevis pins, while the larger sizes have hexagon clevis pins, all of which are available as spares (see page 11).

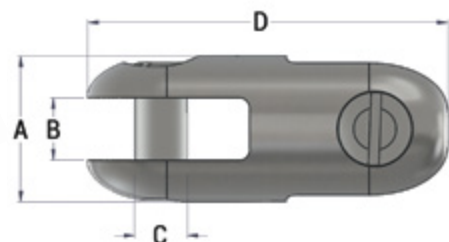

Part No.	3:1 Safe Working Load	A	B	C	D	Weight
00520-010	2,500 lb	7/8"	3/8"	5/16"	2-1/8"	0.17 lb
00520-020	5,000 lb	1-1/4"	17/32"	13/32"	2-7/8"	0.46 lb
00520-027	9,000 lb	1-1/2"	19/32"	1/2"	3-3/8"	0.73 lb
00520-035	15,000 lb	2"	25/32"	11/16"	4-9/16"	2.0 lb
00520-040	25,000 lb	2-13/32"	1"	7/8"	6-7/32"	4.0 lb

## Rope-to-Rope Connector

This product is used to connect two ropes of up to 7/8" dia. The entire product, including sheaves, is manufactured from stainless steel.

Replacement sheaves are available by contacting the customer service department. The sheaves run on standard DCD clevis pins, which are also available as spares (see page 11).

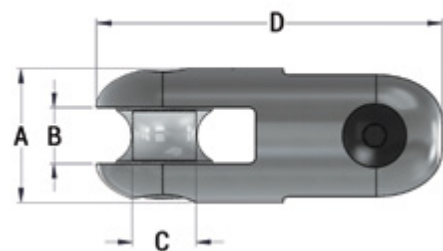

Part No.	3:1 Safe Working Load	Maximum Rope Diameter	A	B	C	D	Weight
00521-020	15,000 lb	5/8"	1-3/4"	3/4"	11/16"	4-7/8"	1.6 lb
00521-035	15,000 lb	7/8"	2"	15/16"	11/16"	5-1/2"	2.7 lb
00521-040	25,000 lb	7/8"	2-13/32"	1"	7/8"	6-7/32"	4.5 lb
00521-045	25,000 lb	1-3/8"	2-29/32"	1-13/32"	7/8"	8-13/32"	9.3 lb

## Rope-to-Swivel Connector

This product is used to connect a swivel to pulling rope. The entire product, including sheave, is manufactured from stainless steel.

Replacement sheaves are available by contacting Customer Service. The sheaves run on standard DCD clevis pins, which are also available as spares (see page 11).

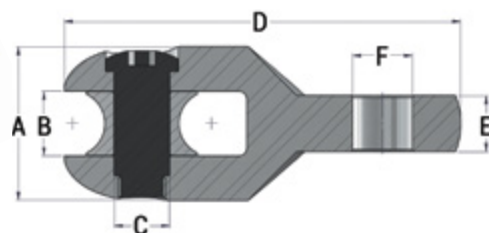

Part No.	3:1 Safe Working Load	Maximum Rope Diameter	A	B	C	D	E	F	Weight	Fits Line Swivel
00522-020	15,000 lb	5/8"	1-3/4"	3/4"	11/16"	4-7/8"	21/32"	3/4"	1.6 lb	00505-030 00505-035
00522-020A	15,000 lb	5/8"			Same as above without sheave				1.3 lb	
00522-025	7,000 lb	7/8"	2"	15/16"	11/16"	5-5/16"	1/2"	17/32"	2.1 lb	00505-020 00505-025 00505-027
00522-025A	7,000 lb	7/8"			Same as above without sheave				1.8 lb	
00522-035	15,000 lb	7/8"	2"	15/16"	11/16"	5-3/8"	21/32"	3/4"	2.3 lb	00505-030 00505-035
00522-035A	15,000 lb	7/8"			Same as above without sheave				2.0 lb	
00522-040	25,000 lb	7/8"	2-3/4"	1"	7/8"	6-7/32"	7/8"	15/16"	3.9 lb	00505-040
00522-040A	25,000 lb	7/8"			Same as above without sheave				3.6 lb	

## Wire Breakaway Connector

The Wire Breakaway Connector is our most recent addition to our family of breakaway connectors. This connector uses a wire instead of a pin to achieve the smallest of break loads. The two-piece design ensures you don't lose parts of your connector when separation does occur. The product is manufactured from stainless steel to provide years of service.

Originally designed to pull 1/2" medium density polyethylene or light duty fiber optic cable, our premier set of breakaway wires designed for this connector will break at different load capacities ensuring your product is protected from damage caused by over-pulling. Break loads from 15 to 200 lb are available.

Wire kits are sold separately in packs of 10.

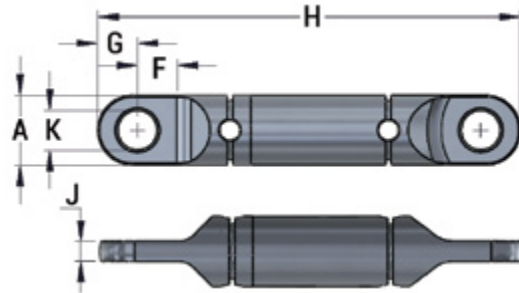

Part No.	A	B	C	D	E	F	G	H	J	K	Weight
00531-010	7/8"	-	-	-	-	1/2"	1/2"	5-11/32"	1/4"	1/2"	0.51 lb

Note: Marine grade versions are available; made to order.

## Wire Breakaway Swivel

This product is similar to our Wire Breakaway Connector (00531 series) as it protects the utility being installed from overload with the addition of a built-in swivel. Changing a wire takes just seconds.

Wire kits are sold separately in packs of 10.

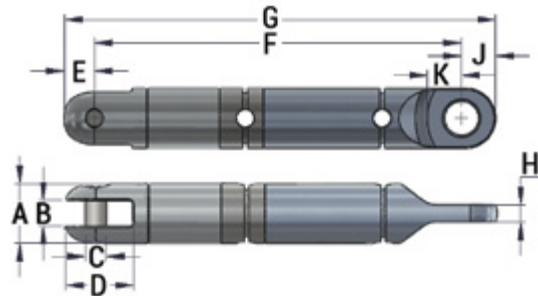
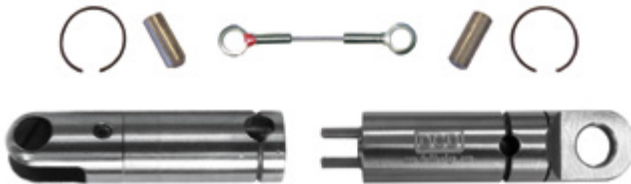

Part No.	A	B	C	D	E	F	G	H	J	K	Weight
00551-010	7/8"	3/8"	5/16"	31/32"	1/2"	5-3/8"	6-1/16"	1/4"	1/2"	1/2"	0.75 lb
00551-010S	7/8"	3/8"	5/16"	31/32"	1/2"	5-3/8"	6-1/16"	1/4"	1/2"	1/2"	0.75 lb

Note: S designates marine grade version.

## Breakaway Wire Kits

Metric and custom sizes are also available on request.

Part No. (10 wires/kit)	Breaking Point (+/- 10%)	Color Code
00536-022*	22 lb	Orange
00536-050	50 lb	Brown
00536-065	65 lb	Green
00536-080	80 lb	Purple
00536-100	100 lb	Red

\* This size has a breaking point of +/- 15%.

Part No. (10 wires/kit)	Breaking Point (+/- 10%)	Color Code
00536-120	120 lb	Blue
00536-140	140 lb	Turquoise
00536-185	185 lb	Pink
00536-200	200 lb	Gray
00536-KT1*	22 lb to 120 lb	Various

\* This is a Sampler Kit with three pins for each of the following: 00536-022, 00536-050, 00536-065, 00536-080, 00536-100, 00536-120.

## Min-E-Max™ Breakaway Connector

The purpose of this product is to protect the utility being installed from overload. Typically, they would be used during the installation of fiber optic cable where the connector can be preset to breakaway at a predetermined load, thus protecting the fibers or the duct. The breakaway pins may be changed to allow the same connector or to be used with a variety of different breakaway pins. Changing a pin takes just seconds.

Breakaway Pin Kits are sold separately in packs of 10.

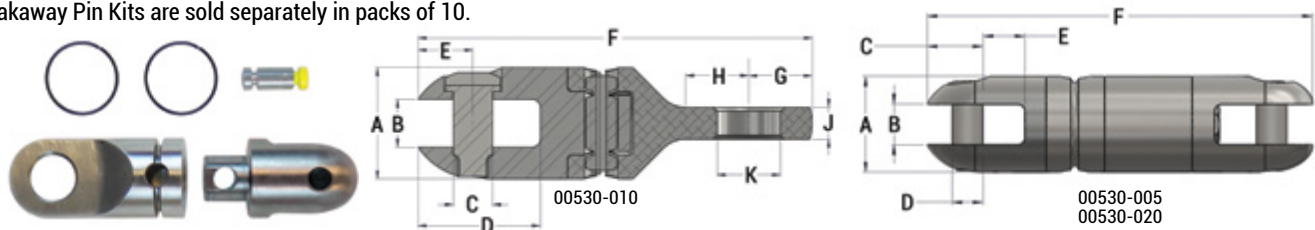

Part No.	A	B	C	D	E	F	G	H	J	K	Use Breakaway Pin Kits in	Weight
00530-005	5/8"	9/32"	7/32"	3/16"	9/32"	2-1/8"	-	-	-	-	Group A	0.10 lb
00530-010	7/8"	3/8"	5/16"	31/32"	7/16"	3-1/8"	1/2"	1/2"	1/4"	1/2"	Group B	0.25 lb
00530-020	1-1/4"	1/2"	3/4"	13/32"	9/16"	5-1/16"	-	-	-	-	Group C	1.03 lb

Note: Marine grade versions are available; made to order.

## Breakaway Swivel

This product is similar to our Breakaway Connector (00530 series) as it protects the utility being installed from overload with the addition of a built-in swivel. The breakaway pins may be changed to allow the same connector or to be used with a variety of different breakaway pins. Changing a pin takes just seconds.

Breakaway Pin Kits are sold separately in packs of 10.

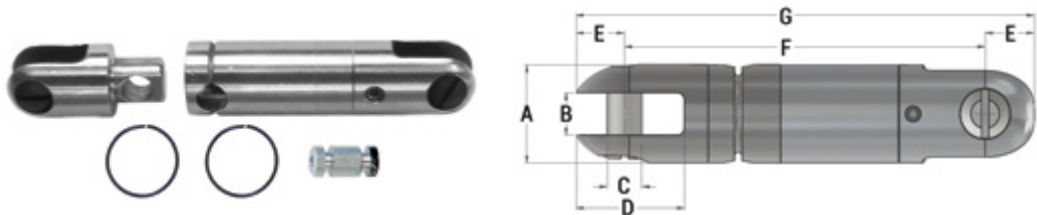

Part No.	A	B	C	D	E	F	G	Use Breakaway Pin Kits in	Weight
00550-005	5/8"	9/32"	3/16"	11/16"	1/4"	2-3/4"	3-1/4"	Group A	0.17 lb
00550-010	7/8"	3/8"	5/16"	31/32"	7/16"	3-3/16"	4-3/16"	Group B	0.42 lb
00550-020	1-1/4"	17/32"	13/32"	1-9/32"	17/32"	4-1/2"	5-9/16"	Group C	1.20 lb

Note: Marine grade versions are available; made to order.

## Breakaway Pin Kits

Metric sizing is also available, as requested.

### Group A

Part No. (10 pins/kit)	Breaking Point (+/- 10%)	Color Code
00555-00125*	125 lb	Green
00555-0015*	150 lb	Black
00555-002	200 lb	White
00555-003	300 lb	Purple
00555-0034	340 lb	Red
00555-004	400 lb	Yellow
00555-0045	450 lb	Blue
00555-006	600 lb	Orange
00555-007	675 lb	Black

### Group B

Part No. (10 pins/kit)	Breaking Point (+/- 10%)	Color Code
00535-002	200 lb	White
00535-004	400 lb	Yellow
00535-005	500 lb	Green
00535-006	600 lb	Orange
00535-006S	600 lb	Blue
00535-008	800 lb	Gray
00535-008S	800 lb	Black
00535-010	1,000 lb	Red

### Group C

Part No. (5 pins/kit)	Breaking Point (+/- 10%)	Color Code
00555-013	1,370 lb	White
00555-018	1,800 lb	Green
00555-020	2,000 lb	Blue
00555-027	2,700 lb	Black
00555-036	3,600 lb	Yellow
00555-040	4,000 lb	Red

US Patent # 5,122,007  
Canadian Patent # 2,109,849

\* Made to order.



## Heavy Duty Breakaway Connectors

These products are designed to protect polyethylene ducting from overload during installation by directional drilling and are used between the pullback swivel and the duct puller. The connectors are a three part product, held together by a group of pins. The pins are designed to break in tension at a specific load.

The assembly of the connector is completed by using one or more of the breakaway pins. The sum of the values of the pins is the value at which the connector will come apart. If a single 1,000 lb pin is used, the connector will come apart at 1,000 lb. If three pins of the same value were used, the connector would come apart at 3,000 lb. Different pin values can be mixed and matched to create a number of different values, all in the same connector. Metric pins are also available. See following pages for pin combinations.

The connectors are available in two sizes. The smaller unit covers values from 750 lb up to 12,500 lb (300 kg-6,000 kg) and the larger unit covers values from 3,000 lb up to 45,000 lb (2,000 kg-20,000 kg).

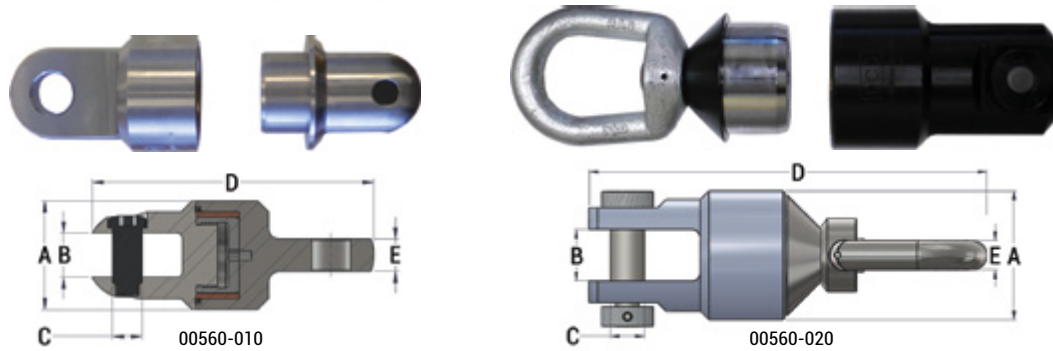

Connector Part No.	A	B	C	D	E	Weight	Replacement Clevis Pin Kit
00560-010	2-1/2"	1"	11/16"	6-1/2"	3/4"	4 lb	00035-HEX
00560-010S	2-1/2"	1"	11/16"	6-1/2"	3/4"	4 lb	00035-HEXS
00560-020	3-3/4"	1-1/2"	1"	12"	7/8"	15 lb	00508-P010
00560-020S	3-3/4"	1-1/2"	1"	12"	7/8"	15 lb	00508-P010S

Note: 'S' designates the connector as a marine grade stainless steel version, intended for use in a marine environment.

## HDD Breakaway Swivel

The HDD Breakaway Swivel is similar to our Heavy Duty Breakaway Connector (00560 series), but with a swivel included. Saving you space in your pullback assembly, the HDD Breakaway Swivel is only 1.5" longer than the 00503-208 Dub-Lite, meaning it's 5" shorter than the alternative of using the DUB-Lite and a Breakaway Connector together.

It will accept the same range of 00565 and 00566 breakaway pins that we offer, which gives the HDD Breakaway Swivel a break load range from 250 lb to 12,500 lb.

The 00570 series is uniquely designed for use in underground HDD applications. A sealed chamber protects the pin(s) from corrosion or damage from the environment. The pins are torqued into place, giving them resistance to fatigue and shock impact, which allows the HDD Breakaway Swivel to avoid premature separation. Seals are designed specifically for HDD environments, giving more longevity to the swivel.

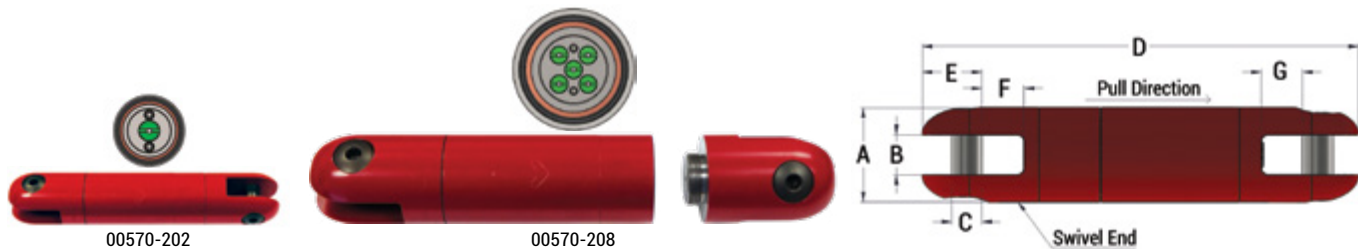

Part No.	Pin Capacity	A	B	C	D	E	F	G	Net Weight	Clevis Pin Kit	Rebuild Kit
00570-202	1 pin	1-1/4" 32 mm	1/2" 13 mm	13/32" 10 mm	5-3/4" 146 mm	3/4" 19 mm	1/2" 13 mm	9/16" 14 mm	1.1 lb 0.5 kg	00020-HEX	-
00570-208	5 pins	2-1/2" 64 mm	1" 25 mm	7/8" 22 mm	12-3/16" 309 mm	1-3/4" 44 mm	7/8" 22 mm	1" 25 mm	12.0 lb 5.5 kg	00040-HEX	00570-K08

## Breakaway Pin Kits

Originally, the DCD breakaway connectors were used by contractors installing gas ducting where it is critical to protect the duct from overload during installation. Many utilities now require the use of a breakaway connector to ensure the final integrity of the ducting.

Use of the breakaway connectors and swivels has expanded over the years to include fiber-optic pulling and line-stringing and has been incorporated into some innovative marine and vehicular towing applications. The versatility of this product is its main feature. It can easily be reset from one value to another allowing the same tool to be used for installation of many different duct sizes each requiring different load settings. To reduce fatigue, install the pin to the specified torque. The pin will not experience fatigue when the load is less than the preload value.

US Patent # 5,599,129  
Canadian Patent # 2,153,743



### 00565 Pin Kits (lb) for 00560-010 & 00570 Breakaways

Part No. (5 pins/kit)	Breaking Point (+/- 5%)	Color Code	Maximum Torque	Preload
00565-025+	250 lb	Brown	0.3 ft-lb	60 lb
00565-040+	400 lb	Gray	0.5 ft-lb	130 lb
00565-070	700 lb	Green/Orange	2.0 ft-lb	420 lb
00565-075	750 lb	Yellow	2.0 ft-lb	540 lb
00565-100	1,000 lb	Orange	3.0 ft-lb	720 lb
00565-120	1,200 lb	Purple	3.0 ft-lb	800 lb
00565-130	1,300 lb	Black	4.0 ft-lb	840 lb
00565-150	1,500 lb	Red	4.0 ft-lb	980 lb
00565-200	2,000 lb	Blue	6.0 ft-lb	1,360 lb
00565-200S	2,000 lb	Gray/Yellow	6.0 ft-lb	1,360 lb
00565-250	2,500 lb	Green	7.0 ft-lb	1,700 lb
00565-250S	2,500 lb	Blue/Red	7.0 ft-lb	1,700 lb

\* This size has a breaking point of +/- 10%.

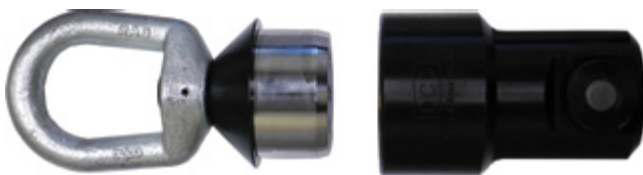

### 00565 Pin Kits (lb) for 00560-020 Breakaways

Part No. (5 pins/kit)	Breaking Point (+/- 5%)	Color Code	Maximum Torque	Preload
00565-300	3,000 lb	Yellow	12 ft-lb	1,853 lb
00565-300S	3,000 lb	Brown	12 ft-lb	1,853 lb
00565-600	6,000 lb	Orange	26 ft-lb	3,680 lb
00565-700	7,000 lb	Red	30 ft-lb	4,160 lb
00565-800	8,000 lb	Blue	33 ft-lb	4,800 lb
00565-900	9,000 lb	Green	33 ft-lb	5,280 lb

Note: 'S' designates a marine grade version.

### 00566 Pin Kits (kg) for 00560-010 & 00570 Breakaways

Part No. (5 pins/kit)	Breaking Point (+/- 5%)	Color Code	Maximum Torque	Preload
00566-030	300 kg	White	2.71 Nm	199 kg
00566-040	400 kg	Beige/Green	4.07 Nm	272 kg
00566-050	500 kg	Turquoise	4.07 Nm	335 kg
00566-100	1,000 kg	Purple/Orange	8.13 Nm	635 kg
00566-120	1,200 kg	Black/White	9.49 Nm	743 kg



### 00566 Pin Kits (kg) for 00560-020 Breakaways

Part No. (5 pins/kit)	Breaking Point (+/- 5%)	Color Code	Maximum Torque	Preload
00566-200	2,000 kg	White	24.40 Nm	1,306 kg
00566-250	2,500 kg	Beige	31.18 Nm	1,669 kg
00566-300	3,000 kg	Turquoise	35.25 Nm	1,886 kg
00566-350	3,500 kg	Purple	37.96 Nm	2,032 kg
00566-400	4,000 kg	Black	42.03 Nm	2,249 kg

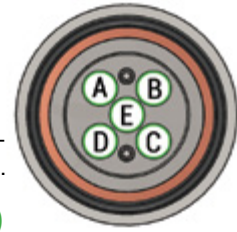

## Breakaway Pin Configuration Options for 00560-010 & 00570-208

The following tables are suggested ways of arriving at required load values. Other combinations are also possible, depending on the connector and pins. The 00560-010 and 00570-208 have 5 pin locations designated as A to E (see diagram).

### Using 00565 Series Pins (lb)

Pin Location (See Diagram)					
A	B	C	D	E	Break Value
-	-	-	-	750	<b>750</b>
-	-	-	-	1,000	<b>1,000</b>
-	-	-	-	1,500	<b>1,500</b>
1,000	-	750	-	-	<b>1,750</b>
-	-	-	-	2,000	<b>2,000</b>
750	-	750	-	750	<b>2,250</b>
750	-	750	-	1,000	<b>2,500</b>
1,000	-	1,000	-	750	<b>2,750</b>
750	750	750	750	-	<b>3,000</b>
750	750	750	1,000	-	<b>3,250</b>
750	1,000	750	1,000	-	<b>3,500</b>
1,500	-	1,500	-	750	<b>3,750</b>
1,000	1,000	1,000	1,000	-	<b>4,000</b>
1,000	750	1,000	750	750	<b>4,250</b>
1,500	-	1,500	-	1,500	<b>4,500</b>
2,000	-	2,000	-	750	<b>4,750</b>
-	2,500	-	2,500	-	<b>5,000</b>
1,500	750	1,500	750	750	<b>5,250</b>
2,000	-	2,000	-	1,500	<b>5,500</b>
1,000	1,500	1,000	1,500	750	<b>5,750</b>
1,500	1,500	1,500	1,500	-	<b>6,000</b>
2,000	750	2,000	750	750	<b>6,250</b>
1,500	750	1,500	750	2,000	<b>6,500</b>
1,500	1,500	1,500	1,500	750	<b>6,750</b>
1,500	2,000	1,500	2,000	-	<b>7,000</b>
2,000	1,000	2,000	1,500	750	<b>7,250</b>
-	2,500	-	2,500	2,500	<b>7,500</b>
2,000	1,500	2,000	1,500	750	<b>7,750</b>
2,000	2,000	2,000	2,000	-	<b>8,000</b>
2,000	1,500	2,000	1,500	1,500	<b>8,500</b>
1,500	2,000	1,500	2,000	2,000	<b>9,000</b>
2,000	2,000	2,000	2,000	1,500	<b>9,500</b>
2,500	2,500	2,500	2,500	-	<b>10,000</b>
2,500	2,000	2,500	2,000	1,500	<b>10,500</b>
2,500	2,500	2,500	2,500	1,000	<b>11,000</b>
2,500	2,500	2,500	2,500	1,500	<b>11,500</b>
2,500	2,500	2,500	2,500	2,000	<b>12,000</b>
2,500	2,500	2,500	2,500	2,500	<b>12,500</b>

Note: Uneven pin distribution may result in up to 10% lower breaking point.

### Using 00566 Series Pins (kg)

Pin Location (See Diagram)					
A	B	C	D	E	Break Value
-	-	-	-	300	<b>300</b>
-	-	-	-	400	<b>400</b>
-	-	-	-	500	<b>500</b>
300	-	300	-	-	<b>600</b>
300	-	400	-	-	<b>700</b>
400	-	400	-	-	<b>800</b>
400	-	500	-	-	<b>900</b>
-	-	-	-	1,000	<b>1,000</b>
400	-	400	-	300	<b>1,100</b>
400	-	400	-	400	<b>1,200</b>
400	-	400	-	500	<b>1,300</b>
500	-	500	-	400	<b>1,400</b>
500	-	500	-	500	<b>1,500</b>
300	-	300	-	1,000	<b>1,600</b>
500	400	500	300	-	<b>1,700</b>
400	-	400	-	1,000	<b>1,800</b>
500	500	500	400	-	<b>1,900</b>
1,000	-	1,000	-	-	<b>2,000</b>
500	400	500	400	300	<b>2,100</b>
500	400	500	400	400	<b>2,200</b>
500	400	500	400	500	<b>2,300</b>
1,200	-	1,200	-	-	<b>2,400</b>
500	500	500	500	500	<b>2,500</b>
1,000	300	1,000	300	-	<b>2,600</b>
1,200	-	1,200	-	300	<b>2,700</b>
1,200	-	1,200	-	400	<b>2,800</b>
1,200	-	1,200	-	500	<b>2,900</b>
1,000	-	1,000	-	1,000	<b>3,000</b>
1,000	400	1,000	400	300	<b>3,100</b>
1,000	400	1,000	400	400	<b>3,200</b>
1,000	400	1,000	400	500	<b>3,300</b>
1,200	-	1,200	-	1,000	<b>3,400</b>
1,200	400	1,200	400	300	<b>3,500</b>
1,200	-	1,200	-	1,200	<b>3,600</b>
1,200	400	1,200	400	500	<b>3,700</b>
1,000	400	1,000	400	1,000	<b>3,800</b>
1,200	500	500	500	500	<b>3,900</b>
1,000	1,000	1,000	1,000	-	<b>4,000</b>
1,000	400	1,000	500	1,200	<b>4,100</b>
1,200	400	1,200	400	1,000	<b>4,200</b>
1,000	1,000	1,000	1,000	300	<b>4,300</b>
1,000	1,000	1,000	1,000	400	<b>4,400</b>
1,000	1,000	1,000	1,000	500	<b>4,500</b>
1,200	500	1,200	500	1,200	<b>4,600</b>
1,000	1,200	1,000	1,200	300	<b>4,700</b>
1,200	1,200	1,200	1,200	-	<b>4,800</b>
1,000	1,200	1,000	1,200	500	<b>4,900</b>
1,000	1,000	1,000	1,000	1,000	<b>5,000</b>
1,200	1,200	1,200	1,200	300	<b>5,100</b>
1,200	1,200	1,200	1,200	400	<b>5,200</b>
1,200	1,200	1,200	1,200	500	<b>5,300</b>
1,200	1,000	1,200	1,000	1,000	<b>5,400</b>
1,200	1,000	1,200	1,000	1,200	<b>5,600</b>
1,200	1,200	1,200	1,200	1,000	<b>5,800</b>
1,200	1,200	1,200	1,200	1,200	<b>6,000</b>



### Breakaway Pin Configuration Options for 00560-020

The following tables are suggested ways of arriving at required load values. Other combinations are also possible, depending on the pins. The 00560-020 has 5 pin locations designated as A to E (see diagram on opposite page).

#### Using 00565 Series Pins (lb)

Pin Location (See Diagram on Page 18)					
A	B	C	D	E	Break Value
-	-	-	-	3,000	<b>3,000</b>
3,000	-	3,000	-	-	<b>6,000</b>
3,000	-	3,000	-	3,000	<b>9,000</b>
6,000	-	6,000	-	-	<b>12,000</b>
3,000	-	3,000	-	7,000	<b>13,000</b>
7,000	-	7,000	-	-	<b>14,000</b>
3,000	-	3,000	-	9,000	<b>15,000</b>
8,000	-	8,000	-	-	<b>16,000</b>
7,000	-	7,000	-	3,000	<b>17,000</b>
9,000	-	9,000	-	-	<b>18,000</b>
8,000	-	8,000	-	3,000	<b>19,000</b>
7,000	-	7,000	-	6,000	<b>20,000</b>
7,000	-	7,000	-	7,000	<b>21,000</b>
7,000	-	7,000	-	8,000	<b>22,000</b>
7,000	-	7,000	-	9,000	<b>23,000</b>
8,000	-	8,000	-	8,000	<b>24,000</b>
8,000	-	8,000	-	9,000	<b>25,000</b>
9,000	-	9,000	-	8,000	<b>26,000</b>
9,000	-	9,000	-	9,000	<b>27,000</b>
7,000	7,000	7,000	7,000	-	<b>28,000</b>
3,000	7,000	3,000	7,000	9,000	<b>29,000</b>
6,000	6,000	6,000	6,000	6,000	<b>30,000</b>
6,000	6,000	6,000	6,000	7,000	<b>31,000</b>
6,000	6,000	6,000	6,000	8,000	<b>32,000</b>
6,000	6,000	6,000	6,000	9,000	<b>33,000</b>
7,000	7,000	7,000	7,000	6,000	<b>34,000</b>
7,000	7,000	7,000	7,000	7,000	<b>35,000</b>
7,000	7,000	7,000	7,000	8,000	<b>36,000</b>
7,000	7,000	7,000	7,000	9,000	<b>37,000</b>
8,000	7,000	8,000	7,000	8,000	<b>38,000</b>
8,000	7,000	8,000	7,000	9,000	<b>39,000</b>
8,000	8,000	8,000	8,000	8,000	<b>40,000</b>
8,000	8,000	8,000	8,000	9,000	<b>41,000</b>
9,000	9,000	9,000	9,000	6,000	<b>42,000</b>
9,000	9,000	9,000	9,000	7,000	<b>43,000</b>
9,000	9,000	9,000	9,000	8,000	<b>44,000</b>
9,000	9,000	9,000	9,000	9,000	<b>45,000</b>

Note: Uneven pin distribution may result in up to 10% lower breaking point.

#### Using 00566 Series Pins (kg)

Pin Location (See Diagram on Page 18)					
A	B	C	D	E	Break Value
-	-	-	-	2,000	<b>2,000</b>
-	-	-	-	3,000	<b>3,000</b>
2,000	-	2,000	-	-	<b>4,000</b>
2,500	-	2,500	-	-	<b>5,000</b>
3,000	-	3,000	-	-	<b>6,000</b>
2,000	-	2,000	-	2,500	<b>6,500</b>
2,000	-	2,000	-	3,000	<b>7,000</b>
2,000	-	2,000	-	3,500	<b>7,500</b>
4,000	-	4,000	-	-	<b>8,000</b>
3,000	-	3,000	-	2,500	<b>8,500</b>
3,000	-	3,000	-	3,000	<b>9,000</b>
3,000	-	3,000	-	3,500	<b>9,500</b>
3,000	-	3,000	-	4,000	<b>10,000</b>
4,000	-	4,000	-	2,500	<b>10,500</b>
4,000	-	4,000	-	3,000	<b>11,000</b>
4,000	-	4,000	-	3,500	<b>11,500</b>
4,000	-	4,000	-	4,000	<b>12,000</b>
2,500	2,500	2,500	2,500	2,500	<b>12,500</b>
2,500	2,500	2,500	2,500	3,000	<b>13,000</b>
2,500	2,500	2,500	2,500	3,500	<b>13,500</b>
2,500	2,500	2,500	2,500	4,000	<b>14,000</b>
3,000	3,000	3,000	3,000	2,500	<b>14,500</b>
3,000	3,000	3,000	3,000	3,000	<b>15,000</b>
3,000	3,000	3,000	3,000	3,500	<b>15,500</b>
3,000	3,000	3,000	3,000	4,000	<b>16,000</b>
3,000	3,500	3,000	3,500	3,500	<b>16,500</b>
3,500	3,500	3,500	3,500	3,000	<b>17,000</b>
3,500	3,500	3,500	3,500	3,500	<b>17,500</b>
3,500	3,500	3,500	3,500	4,000	<b>18,000</b>
4,000	3,500	4,000	3,500	3,500	<b>18,500</b>
4,000	3,500	4,000	3,500	4,000	<b>19,000</b>
4,000	4,000	4,000	4,000	3,500	<b>19,500</b>
4,000	4,000	4,000	4,000	4,000	<b>20,000</b>

## Marine Grade Heavy Duty Breakaway Connector

As the name suggests, this heavy-duty breakaway connector is built with marine grade stainless steel (as designated by the 'S' in the part no.) and is intended as mechanical overload protection for marine applications, such as when installing cable, ducting, or pipe. It uses a new, larger set of breakaway pins (00575 Series) and has a total of 17 pin locations, allowing for a break load range from 4,700 lb to 79,900 lb.

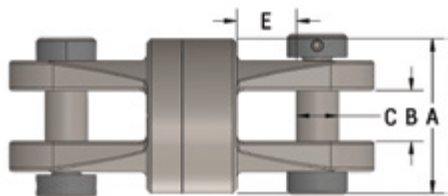
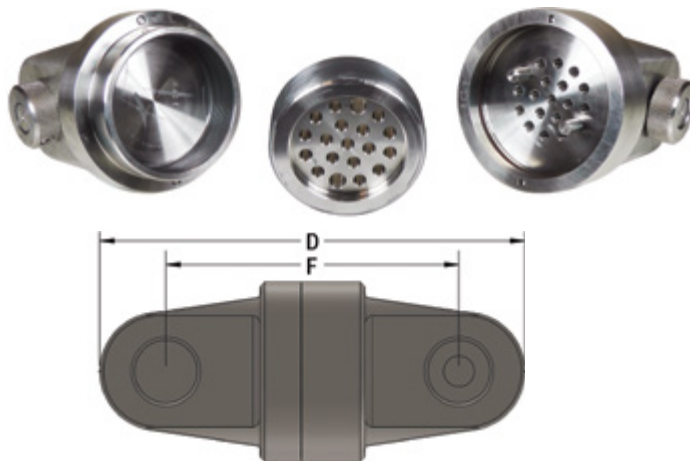

Part No.	A	B	C	D	E	F	Weight	Replacement Clevis Pin Kit
<b>00560-280S</b>	6-1/2"	2-1/8"	1-3/4"	15-5/16"	2-1/2"	10-9/16"	76 lb	<b>00508-040S</b>

Note: Non-marine grade version is available upon request (Part No. 00560-280).



## 00575 Breakaway Pin Kit (lb)

Part No. (14 pins/kit)	Breaking Point (+/- 5%)	Color Code	Maximum Torque	Preload
<b>00575-470</b>	4,700 lb	Blue	13 ft-lb	2,800 lb

Note: Other pin kits with different breaking points are available upon request.

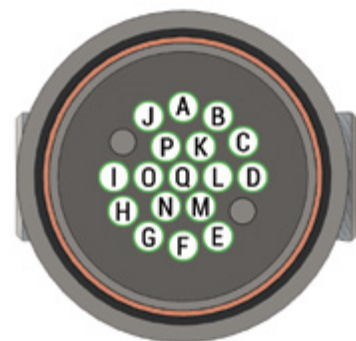

## Breakaway Pin Configuration Options for 00560-280S

The following table provides several suggestions for different pin configurations in the 00560-280S Breakaway Connector and the ultimate break value that will result from each one. With 17 potential pin locations, it is important to balance the pins in a particular way. These values are all achievable with a set of 00575-040 pins, but other pin kits with different break values are available upon request.

Pin Location (See Diagram)																	Break Value	
A	B	C	D	E	F	G	H	I	J	K	L	M	N	O	P	Q		
-	-	-	-	-	-	-	-	-	-	-	-	-	-	-	-	-	4,700	<b>4,700</b>
-	-	-	-	-	-	-	-	-	-	4,700	-	-	4,700	-	-	-	-	<b>9,400</b>
-	-	-	-	-	-	-	-	-	-	4,700	-	4,700	-	4,700	-	-	-	<b>14,100</b>
-	-	-	-	-	-	-	-	-	-	4,700	-	4,700	4,700	-	4,700	-	-	<b>18,800</b>
-	-	-	-	-	-	-	-	-	-	4,700	-	4,700	4,700	4,700	-	4,700	4,700	<b>23,500</b>
-	-	-	-	-	-	-	-	-	-	4,700	4,700	4,700	4,700	4,700	4,700	4,700	-	<b>28,200</b>
-	-	-	-	-	-	-	-	-	-	4,700	4,700	4,700	4,700	4,700	4,700	4,700	4,700	<b>32,900</b>
4,700	-	-	-	-	-	-	-	-	-	4,700	4,700	4,700	4,700	4,700	4,700	4,700	4,700	<b>37,600</b>
4,700	-	-	-	-	4,700	-	-	-	-	4,700	4,700	4,700	4,700	4,700	4,700	4,700	4,700	<b>42,300</b>
-	-	-	4,700	-	-	4,700	-	-	4,700	4,700	4,700	4,700	4,700	4,700	4,700	4,700	4,700	<b>47,000</b>
4,700	-	-	4,700	-	4,700	-	-	4,700	-	4,700	4,700	4,700	4,700	4,700	4,700	4,700	4,700	<b>51,700</b>
4,700	-	4,700	-	4,700	-	4,700	-	4,700	-	4,700	4,700	4,700	4,700	4,700	4,700	4,700	4,700	<b>56,400</b>
-	4,700	-	4,700	4,700	-	4,700	-	4,700	4,700	4,700	4,700	4,700	4,700	4,700	4,700	4,700	4,700	<b>61,100</b>
-	4,700	-	4,700	4,700	4,700	-	4,700	4,700	4,700	4,700	4,700	4,700	4,700	4,700	4,700	4,700	4,700	<b>65,800</b>
4,700	4,700	-	4,700	4,700	4,700	-	4,700	4,700	4,700	4,700	4,700	4,700	4,700	4,700	4,700	4,700	4,700	<b>70,500</b>
4,700	4,700	-	4,700	4,700	4,700	4,700	4,700	4,700	4,700	4,700	4,700	4,700	4,700	4,700	4,700	4,700	4,700	<b>75,200</b>
4,700	4,700	4,700	4,700	4,700	4,700	4,700	4,700	4,700	4,700	4,700	4,700	4,700	4,700	4,700	4,700	4,700	4,700	<b>79,900</b>

Note: Uneven pin distribution may result in up to 10% lower breaking point.

## Magnetic Breakaway Connector

The Magnetic Breakaway Connector is intended as mechanical overload protection for use in low force applications where accuracy and repeatability are required. The connector is intended to be suitable for long term use, where fatigue of traditional mechanical fuses needs to be eliminated, and easy, quick, inexpensive reset of the connector is required. It is used in conjunction with 00537 Series breakaway magnet kits.



Part No.	Separation Load Range	A	B	C	D	Weight	Replacement Clevis Pin Kit
00540-010	50 lb to 80 lb	6-1/2"	2-1/8"	1-3/4"	15-5/16"	2.88 lb	00035-SLT, 00035-HEX

## Magnet Kits for 00540-010 Magnetic Breakaway Connector

The 00540-010 Magnetic Breakaway Connector uses neodymium disc magnets that are available in three different color-coded kits to allow a range of separation loads.



Part No.	Nominal Failure Load	Minimum Failure Load	Maximum Failure Load	Magnets Per Kit	A	B	Color Code	Net Kit Weight
00537-050R*	50 lb per kit	40 lb	60 lb	3	3/8"	3/4"	Blue	0.08 lb
00537-060	60 lb per kit	48 lb	72 lb	7	1/2"	1/2"	Green	0.08 lb
00537-080	80 lb per kit	64 lb	96 lb	7	1/2"	1/2"	Purple	0.08 lb

Note: The magnets are designed to separate within +/- 20% of their nominal failure load.

\* This magnet is coated in a durable layer of rubber.

## Industries serviced by DCD Breakaway products

Our extensive lineup of Breakaway products, ranging from connectors to swivels and utilizing various separation materials, from pins to wires to magnets, services many different industries, including the following:



For more information on our Breakaway products, visit our website at [www.breakawayconnector.com](http://www.breakawayconnector.com).



## Eye to Eye/Clevis Connectors

These connectors are used for many applications. The two halves will not rotate under load, but are useful for aligning products. They are forged from carbon steel and galvanized for protection.



Eye to Eye Part No.	Eye to Clevis Part No.	Nominal Size	5:1 Safe Working Load	Weight
00652-037	00653-037	3/8"	2,250 lb	0.70 lb
00652-050	00653-050	1/2"	3,600 lb	1.36 lb
00652-062	00653-062	5/8"	5,200 lb	2.47 lb
00652-075	-	3/4"	7,200 lb	3.75 lb

## Connecting Shackles

These shackles provide a low cost, economical means of connecting two products together. They are available in two types: one with a bolt, nut and cotter pin for locking (00654 series), the other with a one piece bolt with a flanged head suitable for wire locking if needed (00655 series).

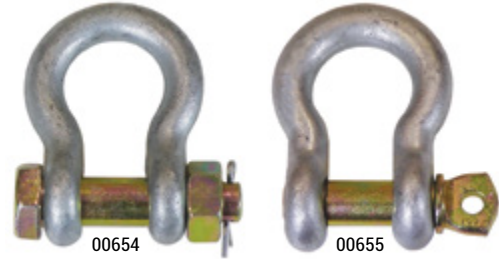

Part No.	Part No.	Nominal Size	6:1 Safe Working Load	Weight
-	00655-018	3/16"	1/3 ton	0.06 lb
-	00655-025	1/4"	1/2 ton	0.11 lb
00654-031	00655-031	5/16"	3/4 ton	0.18 lb
00654-037	00655-037	3/8"	1 ton	0.31 lb
00654-043	00655-043	7/16"	1-1/2 ton	0.43 lb
00654-050	00655-050	1/2"	2 ton	0.68 lb
00654-062	00655-062	5/8"	3-1/4 ton	1.33 lb
-	00655-075	3/4"	4-3/4 ton	2.22 lb
-	00655-087	7/8"	6-1/2 ton	3.39 lb
-	00655-100	1"	8-1/2 ton	4.92 lb
-	00655-112	1-1/8"	9-1/2 ton	7.63 lb
-	00655-125	1-1/4"	12 ton	10.30 lb
-	00655-137	1-3/8"	13-1/2 ton	13.65 lb
-	00655-150	1-1/2"	17 ton	17.90 lb
-	00655-175	1-3/4"	25 ton	29.29 lb
-	00655-200	2"	35 ton	44.00 lb

## Chain-Link Connector

These Chain-Link Connectors are useful and easy to insert in any pulling line. They allow easier bending of a pulling eye or other rigid component when going around bends or sheaves. These high quality products are manufactured with grade 80 steel.



Part No.	Nominal Size	3:1 Safe Working Load	Weight
00656-028	9/32"	4,650 lb	0.29 lb
00656-037	3/8"	9,450 lb	0.77 lb
00656-050	1/2"	16,000 lb	1.59 lb
00656-062	5/8"	24,100 lb	3.13 lb

## Quick Link Connector

The Quick Link Connector can be used in a variety of applications to connect a number of our products to each other. They provide low cost, ease of use, and no maintenance.



Part No.	Nominal Size	2:1 Safe Working Load	Loop Inside Width	Overall Outside Length	Weight
00660-187	3/16"	660 lb	1/2"	2"	0.05 lb
00660-250	1/4"	880 lb	1/2"	2-3/8"	0.08 lb
00660-312	5/16"	1,760 lb	5/8"	3"	0.17 lb
00660-375	3/8"	2,200 lb	11/16"	3-3/16"	0.23 lb
00660-437	7/16"	2,600 lb	3/4"	3-1/2"	0.31 lb
00660-500	1/2"	3,300 lb	7/8"	4-1/8"	0.51 lb

## Wire Rope Bridle Sling

The purpose of this product is to allow multiple pulls at one time by attaching two, three, or four cables or ducts to the puller. The slings are manufactured from aircraft quality wire rope with thimble eyes for durability (tapered swages are also available). The various "legs" are staggered in length so the individual connections are not interfering with each other. The lead coupler can be easily dismantled to change out a leg or to add another leg.

Each leg is marked with load capacity and they have a three times safety factor on that rating. The safety factor is based on equal pull on all cables (horizontal pull only). Couplers and wire rope sling legs may be ordered separately. Other sling configurations are available upon request.

DUB-Lite (00503 series) or Line Swivels (00505 series) are recommended to permit free rotation of the bridle at the legs and coupler. The recommended swivels are sized to suit the load and connection: smaller swivels over the leg loop, a larger swivel to fit the shackle.

Note: Custom lengths and configurations (including 5 & 6-leg versions) are available upon request.



Part No.	Wire Diameter	No. of Legs	3:1 Safe Working Load		Weight	Recommended DUB-Lite		Recommended Line Swivel	
			Leg Capacity	Sling Capacity		Over Shackle	Over Leg Loop	Over Shackle	Over Leg Loop
23125-020	1/8"	2	650 lb	1,300 lb	0.5 lb	00503-202 00503-204 00503-205	00503-202	00505-020	00505-005
23125-030	1/8"	3	650 lb	1,950 lb	0.6 lb			00505-025	00505-010
23125-040	1/8"	4	650 lb	2,600 lb	0.6 lb			00505-027	00505-015
23250-020	1/4"	2	2,300 lb	4,600 lb	1.2 lb	00503-204 00503-205 00503-208 00503-210	00503-202	00505-027	00505-010
23250-030	1/4"	3	2,300 lb	6,900 lb	1.6 lb			00505-030	00505-015
23250-040	1/4"	4	2,300 lb	7,100 lb	2.0 lb			00505-035	00505-020 00505-025
23375-020	3/8"	2	4,800 lb	9,600 lb	2.9 lb	00503-208* 00503-210* 00503-215	00503-204 00503-205 00503-208 00503-210	00505-035†	00505-020
23375-030	3/8"	3	4,800 lb	12,000 lb	3.7 lb			00505-040	00505-025
23375-040	3/8"	4	4,800 lb	18,000 lb	5.9 lb			00505-041	00505-027 00505-030
23500-020	1/2"	2	6,900 lb	13,800 lb	6.7 lb	00503-215	00503-204** 00503-205 00503-208 00503-210	00505-040	00505-030
23500-030	1/2"	3	6,900 lb	20,700 lb	8.6 lb			00505-041	00505-035
23500-040	1/2"	4	6,900 lb	28,300 lb	12.7 lb			00505-045 00505-050	

\* These DUB-Lites do not fit the 23375-040.

\*\* These DUB-Lites do not fit the 23500-040.

† These Line Swivels do not fit the 23375-040.

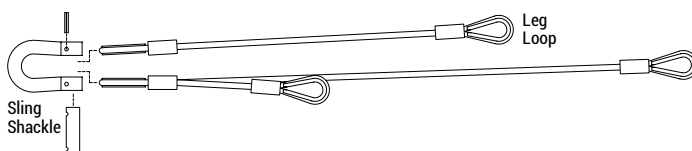

## DCD Pulling Grips

Hand-woven by experienced tradespeople in order to guarantee a consistent level of high quality, DCD Pulling Grips enclose the cable firmly over the entire length of the mesh. They are made of high tensile steel strands. Depending on the type of grip, the strand is comprised of seven, twelve, or nineteen wires. By selecting the most suitable strand, the tension distribution characteristics can be adjusted to suit the requirements.

DCD grips are reverse woven, creating a loop at the end of the grip instead of being soldered or crimped together. These grips meet the highest standards in terms of material and workmanship and we are pleased to offer a wide range of grips with different designs and eye arrangements for onsite (or premise), underground or overhead installations.

The looped pulling head is actually a separate wire rope eye which is placed inside the swage sleeve along with the wire mesh strands. The swage sleeve is then crimped forming an extremely effective anchor point for both the looped head and the wire mesh. Testing proves this is never the weakest link of the product. The flexible eye allows cable to be pulled easily through smaller ducting.

Some DCD grips have rotating heads, which allow the grip to rotate while not under load. DCD also offers the Wire Grip Swivel (pg 27), designed specifically for use with flexible eye grips. It is easily interchangeable, but it will also not rotate under load.

All capacities indicated are approximate breaking strength. Each user must decide what safety factor they require for each specific operation before selecting which grip to use. Due to metal fatigue and possible in-use damage, quoted values only apply to new grips.

Special configurations (double eyes, extra length, etc) may be available as a special factory order. Contact Customer Service with your requirements.



Reverse-Woven Grip End



Looped Pulling Head



Rotating Pulling Head





## Selecting the Correct Grip

Grips are designed for a specific range of cable diameter. To select the correct grip for the job you are pulling:

1. Determine the outside cable diameter. Fit as close as possible to the cable diameter, choosing the size smaller when on a boundary.
2. Wherever possible, use a closed mesh that assembles over the cable end. Use a split mesh when the cable end is not available.
3. Select the eye style best suited to your requirements.
4. Estimate the tension that will be put on the grip and calculate the working load you require, allowing for correct safety factors suitable for the application (3-5 times is typical for pulling grips; refer to your local requirements or practices).
5. Always read breaking strength, safety, and technical data information. Approximate mesh length is measured at an average grip diameter.
6. Taking all of the above into account, look in the size range column of the appropriate grip and determine the part number best suited to your pull.

## Multiple Cable Installation Selection

The following table will assist you in selecting the correct grip size for installations using multiple cables. If the bundle has cables of different diameters, measure the circumference of the bundle and refer to the first column in the table. If the bundle has cables of the same diameter, simply take the diameter from a single cable and refer to the appropriate column based on how many cables are in the bundle.

Mixed Cables: Circumference of Bundle	2 Cables: Diameter of Each Cable	3 Cables: Diameter of Each Cable	4 Cables: Diameter of Each Cable	5 Cables: Diameter of Each Cable	6 or 7 Cables: Diameter of Each Cable	8 Cables: Diameter of Each Cable	9 Cables: Diameter of Each Cable	Required Grip Diameter
1.57" to 1.95"	0.30" to 0.38"	0.25" to 0.31"	0.22" to 0.27"	0.19" to 0.24"	0.17" to 0.22"	0.15" to 0.19"	0.14" to 0.18"	<b>0.50" to 0.61"</b>
1.95" to 2.36"	0.38" to 0.44"	0.31" to 0.36"	0.27" to 0.31"	0.24" to 0.29"	0.22" to 0.26"	0.19" to 0.23"	0.18" to 0.21"	<b>0.62" to 0.74"</b>
2.36" to 3.14"	0.44" to 0.59"	0.36" to 0.49"	0.31" to 0.42"	0.29" to 0.38"	0.26" to 0.34"	0.23" to 0.31"	0.21" to 0.28"	<b>0.75" to 0.99"</b>
3.14" to 3.93"	0.59" to 0.75"	0.49" to 0.63"	0.42" to 0.54"	0.38" to 0.48"	0.34" to 0.43"	0.31" to 0.39"	0.28" to 0.35"	<b>1.00" to 1.24"</b>
3.93" to 4.71"	0.75" to 0.90"	0.63" to 0.76"	0.54" to 0.65"	0.48" to 0.58"	0.43" to 0.52"	0.39" to 0.46"	0.35" to 0.42"	<b>1.25" to 1.49"</b>
4.71" to 5.50"	0.90" to 1.07"	0.76" to 0.89"	0.65" to 0.77"	0.58" to 0.67"	0.52" to 0.60"	0.46" to 0.54"	0.42" to 0.49"	<b>1.50" to 1.74"</b>
5.50" to 6.28"	1.07" to 1.22"	0.89" to 1.02"	0.77" to 0.88"	0.67" to 0.77"	0.60" to 0.69"	0.54" to 0.62"	0.49" to 0.56"	<b>1.75" to 1.99"</b>
6.28" to 7.85"	1.22" to 1.53"	1.02" to 1.28"	0.88" to 1.10"	0.77" to 0.96"	0.69" to 0.86"	0.62" to 0.77"	0.56" to 0.71"	<b>2.00" to 2.49"</b>
7.85" to 9.42"	1.53" to 1.83"	1.28" to 1.53"	1.10" to 1.32"	0.96" to 1.16"	0.86" to 1.03"	0.77" to 0.93"	0.71" to 0.85"	<b>2.50" to 2.99"</b>
9.42" to 11.00"	1.83" to 2.14"	1.53" to 1.79"	1.32" to 1.54"	1.16" to 1.35"	1.03" to 1.20"	0.93" to 1.08"	0.85" to 0.99"	<b>3.00" to 3.49"</b>
11.00" to 12.57"	2.14" to 2.44"	1.79" to 2.05"	1.54" to 1.76"	1.35" to 1.54"	1.20" to 1.37"	1.08" to 1.24"	0.99" to 1.13"	<b>3.50" to 3.99"</b>
12.57" to 14.14"	2.44" to 2.75"	2.05" to 2.30"	1.76" to 1.98"	1.54" to 1.74"	1.37" to 1.55"	1.24" to 1.39"	1.13" to 1.27"	<b>4.00" to 4.49"</b>
14.14" to 15.71"	2.75" to 3.06"	2.30" to 2.56"	1.98" to 2.20"	1.74" to 1.93"	1.55" to 1.72"	1.39" to 1.55"	1.27" to 1.41"	<b>4.50" to 4.99"</b>

## Wire Grip Swivel

These swivels can be used in conjunction with DCD Wire Mesh Grips or standard 1/4" to 1/2" rope. They will allow the utility being installed to "unwind" as it is being pulled in, but like the rotary heads, these swivels will not rotate under load.



Part No.	Minimum Breaking Strength	A	B	C	Weight
<b>00501-010</b>	10,000 lb	1-1/4"	9/16"	7"	1.5 lb
<b>00501-025</b>	25,000 lb	1-5/8"	9/16"	8-5/8"	3.2 lb

## Single Weave, Single Eye, Light Duty

These grips offer a flexible eye with single weave galvanized wire construction for light duty applications, pulling single or grouped cable, where a small profile is needed. A standard kit is also available in a pouch.

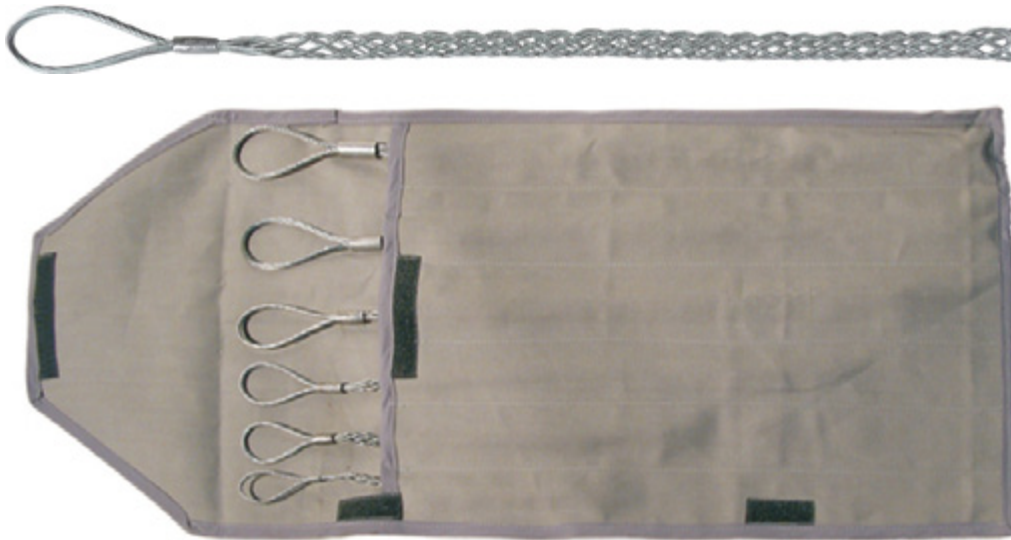

Kit with Pouch (00661-JGK)

Part No.	Size Range	Approximate Mesh Length	Approximate Breaking Strength	Weight
00661-004	0.15" to 0.24"	6-1/2"	400 lb	0.01 lb
00661-006	0.25" to 0.37"	6-1/2"	460 lb	0.01 lb
00661-010	0.38" to 0.49"	7-1/2"	860 lb	0.03 lb
00661-013	0.50" to 0.62"	9"	1,250 lb	0.06 lb
00661-016	0.63" to 0.74"	12"	1,790 lb	0.09 lb
00661-019	0.75" to 0.99"	12"	2,580 lb	0.13 lb
00661-025	1.00" to 1.24"	12-1/2"	4,090 lb	0.22 lb
00661-JGK	Kit with pouch that includes one of all above parts except 00661-004			0.90 lb

## Non-Conductive, Single/Double Weave, Single Eye

These grips are non-metallic and non-conductive, which is ideal for use in damp conditions or off-shore applications. The high-strength aramid fibers are coated, lightweight and flexible: ideal for installing fiber optic cable or other high-tech cables. Smaller sizes are single weave, larger sizes are double weave.



Part No.	Size Range	Weave	Approximate Mesh Length	Approximate Breaking Strength	Weight
00662-010	0.38" to 0.74"	Single	34"	2,500 lb	0.12 lb
00662-020	0.75" to 1.12"	Single	35"	3,700 lb	0.18 lb
00664-030	1.13" to 1.49"	Double	35"	9,800 lb	0.22 lb
00664-040	1.50" to 1.99"	Double	38"	11,800 lb	0.46 lb

## Double Weave, Single Eye

These grips offer a flexible eye and double weave galvanized wire construction for regular load pulls. The galvanized steel braid offers durability for underground installations and other more demanding situations.



Part No.	Size Range	Approximate Mesh Length	Approximate Breaking Strength	Weight
00670-025	0.24" to 0.37"	18"	4,250 lb	0.21 lb
00670-038	0.38" to 0.74"	18"	5,000 lb	0.34 lb
00670-050	0.75" to 1.12"	20"	6,600 lb	0.47 lb
00670-100	1.13" to 1.49"	21"	10,000 lb	0.69 lb
00670-125	1.50" to 1.99"	24"	13,800 lb	1.43 lb
00670-200	2.00" to 2.49"	24"	14,200 lb	1.47 lb
00670-250	2.50" to 2.99"	28"	17,500 lb	1.90 lb
00671-080	3.00" to 3.74"	30"	18,000 lb	2.59 lb
00671-095	3.75" to 4.24"	32"	26,500 lb	3.52 lb

## Double Weave, Single Eye, Slack Grip, Closed Mesh

These grips offer an offset, flexible eye and durable, double-weave galvanized wire construction for an offset pull arrangement or pulling at the mid-span of the cable. Use this style if the end is available and the grip can be mounted directly onto the cable, leaving the cable end free.



Part No.	Size Range	Approximate Mesh Length	Approximate Breaking Strength	Weight
00674-010	0.38" to 0.74"	14"	2,500 lb	0.45 lb
00674-020	0.75" to 1.12"	17"	3,000 lb	0.50 lb
00674-030	1.13" to 1.49"	18"	5,000 lb	0.75 lb
00674-040	1.50" to 1.99"	20"	10,000 lb	1.54 lb
00675-050	2.00" to 2.49"	20"	11,000 lb	1.53 lb
00675-065	2.50" to 2.99"	22"	12,000 lb	1.85 lb
00675-080	3.00" to 3.74"	24"	15,000 lb	2.02 lb
00675-095	3.75" to 4.24"	24"	15,000 lb	4.32 lb

## Double Weave, Single Eye, Slack Grip, Split Mesh (Lace-up)

Similar to the 00674/00675 above, these grips offer an offset eye and double weave wire for offset or mid-span pulls. Use the laced, split-mesh grips if the end of the cable is not available or the grip cannot be mounted over the end fitting.



Part No.	Size Range	Approximate Mesh Length	Approximate Breaking Strength	Weight
00678-010	0.38" to 0.74"	14"	4,100 lb	0.40 lb
00678-020	0.75" to 1.12"	17"	4,970 lb	0.53 lb
00678-030	1.13" to 1.49"	18"	8,150 lb	0.81 lb
00678-040	1.50" to 1.99"	20"	12,100 lb	1.47 lb
00679-050	2.00" to 2.49"	21"	16,140 lb	1.74 lb
00679-065	2.50" to 2.99"	22"	16,140 lb	2.09 lb
00679-080	3.00" to 3.74"	24"	20,170 lb	2.69 lb
00679-095	3.75" to 4.24"	24"	23,400 lb	2.94 lb



## Double Weave, Single Eye, Shoulders

These grips offer a flexible eye with shoulders and double weave galvanized wire construction. The shoulders offer added protection to the utility being pulled in as well as protecting the leading wire strands.



Part No.	Size Range	Approximate Mesh Length	Approximate Breaking Strength	Weight
00680-025	0.25" to 0.49"	18"	4,800 lb	0.25 lb
00680-038	0.50" to 0.74"	18"	5,800 lb	0.38 lb
00680-050	0.75" to 1.12"	24"	6,700 lb	0.61 lb
00680-100	1.13" to 1.49"	24"	10,000 lb	0.87 lb
00680-125	1.50" to 1.99"	24"	16,400 lb	1.31 lb
00680-200	2.00" to 2.49"	24"	18,500 lb	1.76 lb
00680-250	2.50" to 2.99"	36"	24,500 lb	3.32 lb
00680-300	3.00" to 3.74"	36"	24,500 lb	3.33 lb
00680-350	3.75" to 4.24"	48"	31,000 lb	6.56 lb
00680-400	4.25" to 4.99"	48"	31,000 lb	7.64 lb

## Triple Weave, Single Eye, Shoulders

These grips offer a color-coded, flexible eye with shoulders and triple weave galvanized wire construction. The shoulders help to protect the leading edge of the cable or ducting and this type should be used for more demanding, heavy duty applications.



Part No.	Color Code	Size Range	Approximate Mesh Length	Approximate Breaking Strength	Weight
00681-006	Dark Green	0.25" to 0.49"	28"	6,500 lb	0.41 lb
00681-012	Brown	0.50" to 0.74"	33"	10,400 lb	0.79 lb
00681-019	Light Blue	0.75" to 0.99"	41"	16,000 lb	1.47 lb
00681-025	Gold	1.00" to 1.24"	51"	25,400 lb	3.46 lb
00681-032	Black	1.25" to 1.49"	60"	31,700 lb	4.11 lb
00681-038	Red	1.50" to 1.99"	75"	32,000 lb	4.81 lb
00681-048	Yellow	2.00" to 2.49"	75"	44,600 lb	8.12 lb

## Dual Wire, Double Weave, High Strength, Shoulders

These extra high strength grips feature a dual wire, double woven construction. This type of grip should be used for heavy duty applications such as overhead transmission wire. The color-coded grips are particularly suited to bare conductor and synthetic rope applications. When pulling rope of any kind, it may be difficult to feed the leading end of the rope into the grip and we recommend use of the Feed Tube (see page 32) to help with these situations.



Part No.	Color Code	Conductor Size Range	Rope Size Range	Approximate Mesh Length	Head Length	Approximate Breaking Strength	Weight
00695-019	Black	0.19" to 0.37"	0.25" to 0.65"	24"	10"	6,800 lb	0.61 lb
00695-038	Dark Green	0.38" to 0.62"	0.50" to 0.90"	36"	12"	14,500 lb	1.56 lb
00695-063	Red	0.63" to 0.87"	0.75" to 1.10"	48"	13"	21,500 lb	2.53 lb
00695-088	Dark Blue	0.88" to 1.12"	1.00" to 1.50"	60"	15"	32,000 lb	6.14 lb
00695-113	Yellow	1.13" to 1.37"	1.25" to 1.70"	76"	18"	48,000 lb	13.06 lb
00695-138	Aluminum	1.38" to 1.90"	1.50" to 2.10"	89"	24"	68,000 lb	19.87 lb

## Rotary Head Grips

The following two grips have a rotary head that can be fitted to a DCD Line Swivel (00505 series) for smooth rotation or linked to a shackle in the pulling string.

Please note that the rotating head does not replace the use of a Line Swivel. There are no bearings to allow rotation under load and severe damage may occur to the utility being installed if this product is used without the correct swivel. Select the appropriate swivel and safe working load based on your applied safety factors.

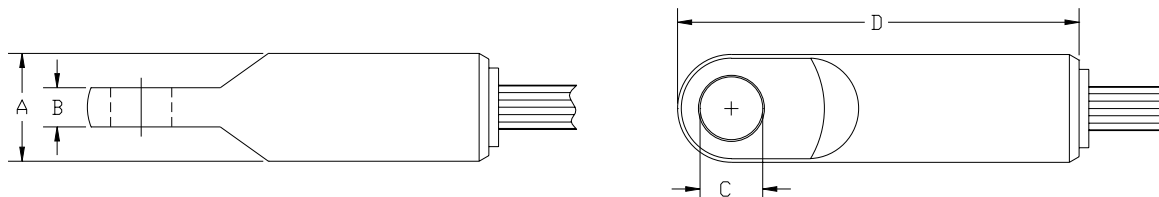

## Triple Weave, Rotary Head, Shoulders

These grips offer a stainless steel rotary head with color-coded shoulders and triple-weave galvanized wire construction for extra strength. The shoulders help to protect the leading edge of the cable or ducting and this type should be used for heavy duty applications.



Part No.	Color Code	Size Range	Approximate Mesh Length	A	B	C	D	Approximate Breaking Strength	Weight
00682-006	Dark Green	0.25" to 0.49"	28"	7/8"	5/16"	1/2"	2-3/4"	6,500 lb	0.53 lb
00682-012	Brown	0.50" to 0.74"	33"	1"	1/2"	9/16"	3-7/8"	10,400 lb	1.05 lb
00682-019	Light Blue	0.75" to 0.99"	41"	1"	1/2"	9/16"	3-7/8"	16,000 lb	1.54 lb
00682-025	Gold	1.00" to 1.24"	51"	1-3/8"	1/2"	11/16"	5-3/8"	25,400 lb	3.85 lb
00682-032	Black	1.25" to 1.49"	60"	1-5/8"	9/16"	7/8"	6-1/8"	31,700 lb	5.27 lb
00682-038	Red	1.50" to 1.99"	75"	1-7/8"	21/32"	1"	7-3/8"	33,000 lb	7.19 lb
00682-048	Yellow	2.00" to 2.49"	75"	1-7/8"	21/32"	1"	7-3/8"	44,600 lb	9.51 lb

## Double Weave, Rotary Head, Shoulders

These grips offer a stainless steel rotary head with double-weave galvanized wire construction for durability. The shoulders help to protect the leading edge of the cable or ducting and this type should be used for medium to heavy duty applications.



Part No.	Size Range	Approximate Mesh Length	A	B	C	D	Approximate Breaking Strength	Weight
00690-038	0.50" to 0.74"	16"	7/8"	5/16"	1/2"	2-3/4"	5,800 lb	0.49 lb
00690-050	0.75" to 1.12"	24"	7/8"	5/16"	1/2"	2-3/4"	6,700 lb	0.72 lb
00690-100	1.13" to 1.49"	33"	1-3/8"	1/2"	11/16"	5-3/8"	13,000 lb	2.31 lb
00690-125	1.50" to 1.99"	36"	1-3/8"	1/2"	11/16"	5-3/8"	16,500 lb	3.00 lb
00690-200	2.00" to 2.49"	36"	1-5/8"	9/16"	7/8"	6-1/8"	21,000 lb	4.27 lb
00690-250	2.50" to 2.99"	38"	1-7/8"	21/32"	1"	7-3/8"	33,000 lb	7.03 lb
00690-300	3.00" to 3.74"	39"	1-7/8"	21/32"	1"	7-3/8"	41,000 lb	7.29 lb
00690-350	3.75" to 4.24"	42"	1-7/8"	21/32"	1"	7-3/8"	48,000 lb	8.55 lb
00690-400	4.25" to 4.99"	58"	1-7/8"	21/32"	1"	7-3/8"	48,000 lb	10.88 lb

## Feed Tube for Rope (used with 00695 Series)

When pulling rope, this Feed Tube can be used to help feed the leading end of the rope into the grip. See page 30 for details on the 00695 Series.



Part No.	Rope Size Range	Tube Length	Weight
00696-019	0.25" to 0.65"	28"	0.94 lb
00696-038	0.50" to 0.90"	40"	2.32 lb
00696-063	0.75" to 1.10"	52"	2.71 lb
00696-088	1.00" to 1.50"	67"	5.65 lb
00696-113	1.25" to 1.70"	83"	9.20 lb
00696-138	1.50" to 2.10"	96"	10.28 lb

## Double Weave, Open Ends

These grips are open at both ends to splice rope or cable ends together (ex. for elevator or crane rope replacement) and have a double weave galvanized wire construction. The old cable may be attached to the new one and simply pulled through the blocks.



Part No.	Rope Size Range	Approximate Mesh Length	Approximate Breaking Strength	Weight
00697-010	0.38" to 0.74"	60"	4,100 lb	0.58 lb
00697-020	0.75" to 1.12"	60"	4,974 lb	0.83 lb

## Fiber Headboard

Originally intended for pulling OPGW cable, the Fiber Headboard is an anti-torsional device for applications in which you don't want rotation to occur. It incorporates a 00505-035 Line Swivel at the lead (pulling line) end, a 00520-035 Can-Link Connector at the tail (cable) end, and three dangling arms providing the torque stability required to prevent turning.

Part No.	Approximate Length	5:1 Safe Working Load	Weight
00698-035	20'	8,500 lb	180 lb

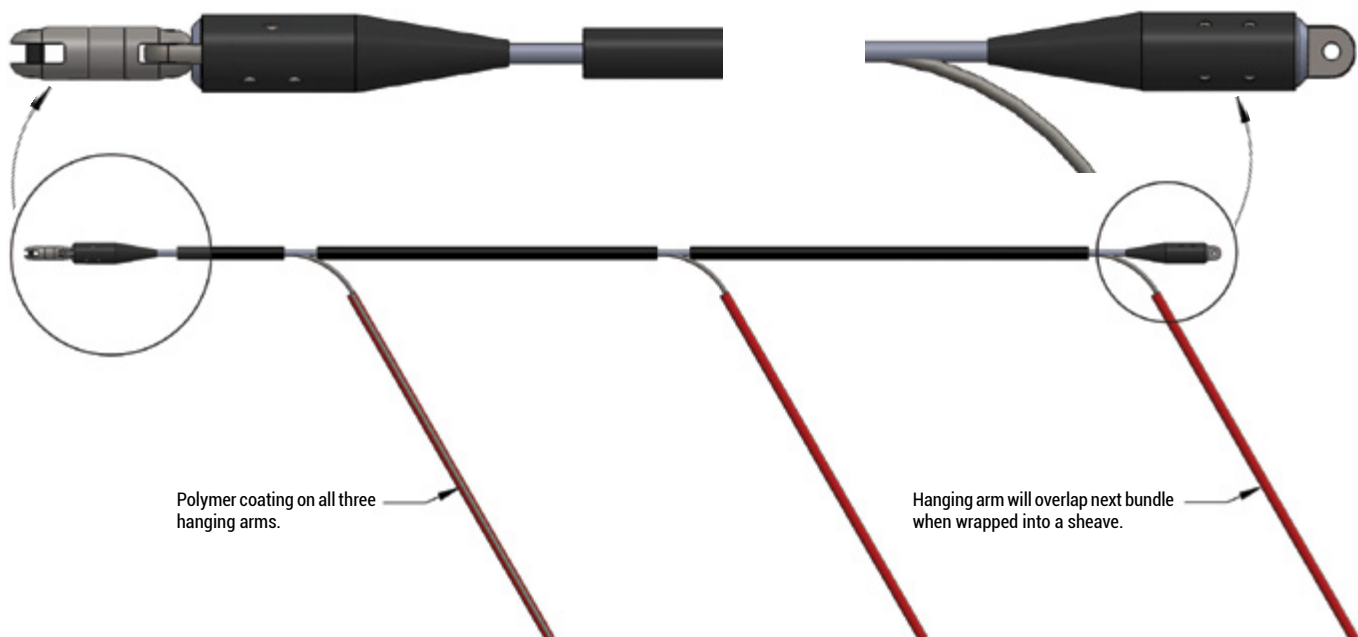



## Support Grips

Cable Support Grips are used for supporting any kind of cable in permanent installations. They can be used in either horizontal or vertical installations to relieve the cable weight from connections and fixtures. DCD grips are manufactured of durable galvanized steel wire for indoor or under cover installations. For installations exposed to weather, stainless steel versions are available for all types.

DCD offers three basic types of eye: single, double or offset. Each type is available in single weave for light duty applications, double weave for heavy duty applications, or lace-up weave when the cable end is not available for slipping the grip over. Support grips are produced on demand, particularly in stainless steel, except in some of the most common sizes. Typically, support grips are ordered in bulk for annual utility supply contracts. Please allow 8-10 weeks for delivery; some exceptions may apply. Contact Customer Service for availability.

Note: Always read breaking strength, safety, and technical data information. Approximate mesh length is measured at an average grip diameter. For stainless steel grips, reduce Approximate Breaking Strength by 10%.



### Single Eye, Single Weave, Closed Mesh

For permanent installations, horizontal or vertical, where the cable end is available for assembly of the support grip.



Galvanized Part No.	Stainless Part No.	Size Range	Approximate Mesh Length	Approximate Breaking Strength	Weight
00800-016	00800-016S	0.15" to 0.24"	4"	350 lb	0.02 lb
00800-024	00800-024S	0.25" to 0.29"	4"	550 lb	0.03 lb
00800-031	00800-031S	0.30" to 0.39"	5"	900 lb	0.04 lb
00800-039	00800-039S	0.40" to 0.49"	5"	900 lb	0.04 lb
00800-051	00800-051S	0.50" to 0.62"	7"	900 lb	0.04 lb
00800-063	00800-063S	0.63" to 0.74"	10"	1,750 lb	0.11 lb
00800-079	00800-079S	0.75" to 0.99"	10"	2,100 lb	0.12 lb
00800-098	00800-098S	1.00" to 1.24"	13"	3,050 lb	0.19 lb
00800-118	00800-118S	1.25" to 1.49"	13"	3,050 lb	0.20 lb
00800-150	00800-150S	1.50" to 1.74"	15"	3,050 lb	0.21 lb
00800-173	00800-173S	1.75" to 1.99"	15"	4,050 lb	0.31 lb
00800-197	00800-197S	2.00" to 2.49"	19"	5,700 lb	0.55 lb
00800-252	00800-252S	2.50" to 2.99"	19"	5,700 lb	1.00 lb
00800-299	00800-299S	3.00" to 3.49"	19"	14,250 lb	1.10 lb
00800-350	00800-350S	3.50" to 3.99"	20"	14,250 lb	1.30 lb

## Double Eye, Single Weave, Closed Mesh

Fitted with a double eye, for permanent installations where the cable end is available for assembly of the support grip.



Galvanized Part No.	Stainless Part No.	Size Range	Approximate Mesh Length	Approximate Breaking Strength	Weight
00801-051	00801-051S	0.50" to 0.62"	7"	900 lb	0.05 lb
00801-063	00801-063S	0.63" to 0.74"	10"	1,750 lb	0.09 lb
00801-079	00801-079S	0.75" to 0.99"	10"	2,100 lb	0.11 lb
00801-098	00801-098S	1.00" to 1.24"	13"	3,050 lb	0.19 lb
00801-118	00801-118S	1.25" to 1.49"	13"	3,050 lb	0.19 lb
00801-150	00801-150S	1.50" to 1.74"	15"	3,050 lb	0.21 lb
00801-173	00801-173S	1.75" to 1.99"	15"	4,050 lb	0.35 lb
00801-197	00801-197S	2.00" to 2.49"	19"	5,700 lb	0.43 lb
00801-252	00801-252S	2.50" to 2.99"	19"	5,700 lb	1.01 lb
00801-299	00801-299S	3.00" to 3.49"	19"	14,250 lb	1.23 lb
00801-350	00801-350S	3.50" to 3.99"	20"	14,250 lb	1.32 lb

## Offset Eye, Single Weave, Closed Mesh

For permanent installations where the support point is offset and the cable end is available for assembly of the support grip.

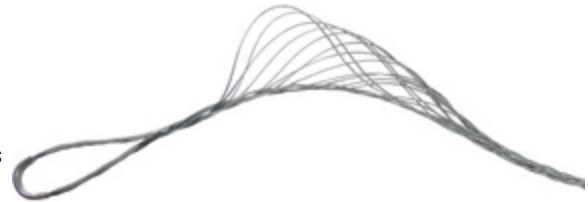

Galvanized Part No.	Stainless Part No.	Size Range	Approximate Mesh Length	Approximate Breaking Strength	Weight
00802-051	00802-051S	0.50" to 0.62"	7"	900 lb	0.04 lb
00802-063	00802-063S	0.63" to 0.74"	10"	1,750 lb	0.09 lb
00802-079	00802-079S	0.75" to 0.99"	10"	2,100 lb	0.11 lb
00802-098	00802-098S	1.00" to 1.24"	13"	3,050 lb	0.16 lb
00802-118	00802-118S	1.25" to 1.49"	13"	3,050 lb	0.17 lb
00802-150	00802-150S	1.50" to 1.74"	15"	3,050 lb	0.18 lb
00802-173	00802-173S	1.75" to 1.99"	15"	4,050 lb	0.27 lb
00802-197	00802-197S	2.00" to 2.49"	19"	5,700 lb	1.01 lb
00802-252	00802-252S	2.50" to 2.99"	19"	5,700 lb	1.01 lb
00802-299	00802-299S	3.00" to 3.49"	19"	14,250 lb	1.10 lb
00802-350	00802-350S	3.50" to 3.99"	20"	14,250 lb	1.32 lb

## Single Eye, Double Weave, Closed Mesh

For heavy duty permanent installations, horizontal or vertical, where the cable end is available for assembly of the support grip.



Galvanized Part No.	Stainless Part No.	Size Range	Approximate Mesh Length	Approximate Breaking Strength	Weight
00820-039	00820-039S	0.38" to 0.74"	25"	5,800 lb	0.42 lb
00820-079	00820-079S	0.75" to 1.12"	25"	6,650 lb	0.60 lb
00820-118	00820-118S	1.13" to 1.49"	30"	10,000 lb	1.11 lb
00820-157	00820-157S	1.50" to 1.99"	34"	13,800 lb	1.50 lb

### Double Eye, Double Weave, Closed Mesh

Fitted with a double eye, for heavy duty permanent installations where the cable end is available for assembly of the support grip.



Galvanized Part No.	Stainless Part No.	Size Range	Approximate Mesh Length	Approximate Breaking Strength	Weight
00821-079	00821-079S	0.75" to 1.12"	25"	6,650 lb	0.60 lb
00821-118	00821-118S	1.13" to 1.49"	30"	10,000 lb	1.14 lb
00821-150	00821-150S	1.50" to 1.99"	34"	13,800 lb	1.64 lb
00821-197	00821-197S	2.00" to 2.49"	37"	15,000 lb	2.02 lb
00821-256	00821-256S	2.50" to 3.12"	43"	17,500 lb	3.45 lb
00821-315	00821-315S	3.13" to 3.74"	43"	18,000 lb	4.14 lb

### Single Eye, Single Weave, Split Mesh (Lace-up)

For permanent installations where the cable end is not available for assembly of the support grip, the support grip may be laced over the mid-span.



Galvanized Part No.	Stainless Part No.	Size Range	Approximate Mesh Length	Approximate Breaking Strength	Weight
00810-051	00810-051S	0.50" to 0.62"	5"	900 lb	0.05 lb
00810-063	00810-063S	0.63" to 0.74"	10"	1,750 lb	0.12 lb
00810-079	00810-079S	0.75" to 0.99"	10"	2,100 lb	0.15 lb
00810-098	00810-098S	1.00" to 1.24"	13"	3,050 lb	0.19 lb
00810-118	00810-118S	1.25" to 1.49"	13"	3,050 lb	0.22 lb
00810-150	00810-150S	1.50" to 1.99"	15"	3,050 lb	0.24 lb
00810-197	00810-197S	2.00" to 2.49"	19"	5,700 lb	0.57 lb
00810-252	00810-252S	2.50" to 2.99"	19"	5,700 lb	0.88 lb
00810-299	00810-299S	3.00" to 3.49"	19"	14,250 lb	1.10 lb
00810-350	00810-350S	3.50" to 3.99"	20"	14,250 lb	1.32 lb

### Double Eye, Single Weave, Split Mesh (Lace-up)

Fitted with a double eye, for permanent installations where the cable end is not available for assembly of the support grip, the grip may be laced over the mid-span.



Galvanized Part No.	Stainless Part No.	Size Range	Approximate Mesh Length	Approximate Breaking Strength	Weight
00811-051	00811-051S	0.50" to 0.62"	5"	900 lb	0.05 lb
00811-063	00811-063S	0.63" to 0.74"	10"	1,750 lb	0.12 lb
00811-079	00811-079S	0.75" to 0.99"	10"	2,100 lb	0.15 lb
00811-098	00811-098S	1.00" to 1.24"	13"	3,050 lb	0.21 lb
00811-118	00811-118S	1.25" to 1.49"	13"	3,050 lb	0.21 lb
00811-150	00811-150S	1.50" to 1.99"	15"	3,050 lb	0.24 lb
00811-197	00811-197S	2.00" to 2.49"	19"	5,700 lb	0.55 lb
00811-252	00811-252S	2.50" to 2.99"	19"	5,700 lb	0.88 lb
00811-299	00811-299S	3.00" to 3.49"	19"	14,250 lb	1.10 lb
00811-350	00811-350S	3.50" to 3.99"	20"	14,250 lb	1.32 lb



## Offset Eye, Single Weave, Split Mesh (Lace-up)

For permanent installations where the support point is offset and the cable end is not available for assembly of the support grip, the support grip may be laced over the mid-span.



Galvanized Part No.	Stainless Part No.	Size Range	Approximate Mesh Length	Approximate Breaking Strength	Weight
00812-051	00812-051S	0.50" to 0.62"	5"	900 lb	0.05 lb
00812-063	00812-063S	0.63" to 0.74"	10"	1,750 lb	0.09 lb
00812-079	00812-079S	0.75" to 0.99"	10"	2,100 lb	0.11 lb
00812-098	00812-098S	1.00" to 1.24"	13"	3,050 lb	0.17 lb
00812-118	00812-118S	1.25" to 1.49"	13"	3,050 lb	0.19 lb
00812-150	00812-150S	1.50" to 1.99"	15"	3,050 lb	0.19 lb
00812-197	00812-197S	2.00" to 2.49"	19"	5,700 lb	0.56 lb
00812-252	00812-252S	2.50" to 2.99"	19"	5,700 lb	1.01 lb
00812-299	00812-299S	3.00" to 3.49"	19"	14,250 lb	1.23 lb
00812-350	00812-350S	3.50" to 3.99"	20"	14,250 lb	1.32 lb

## Single Eye, Double Weave, Split Mesh (Lace-up)

For heavy duty permanent installations where the cable end is not available for assembly of the support grip, the support grip may be laced over the mid-span.



Galvanized Part No.	Stainless Part No.	Size Range	Approximate Mesh Length	Approximate Breaking Strength	Weight
00830-079	00830-079S	0.75" to 1.12"	25"	6,650 lb	0.62 lb
00830-118	00830-118S	1.13" to 1.49"	30"	10,000 lb	1.13 lb
00830-150	00830-150S	1.50" to 1.99"	34"	13,800 lb	1.72 lb

## Double Eye, Double Weave, Split Mesh (Lace-up)

Fitted with a double eye, for heavy duty permanent installations where the cable end is not available for assembly of the support grip, the support grip may be laced over the mid-span.



Galvanized Part No.	Stainless Part No.	Size Range	Approximate Mesh Length	Approximate Breaking Strength	Weight
00831-079	00831-079S	0.75" to 1.12"	25"	6,650 lb	0.61 lb
00831-118	00831-118S	1.13" to 1.49"	30"	10,000 lb	1.19 lb
00831-150	00831-150S	1.50" to 1.99"	34"	13,800 lb	1.87 lb
00831-197	00831-197S	2.00" to 2.49"	37"	15,000 lb	2.77 lb
00831-256	00831-256S	2.50" to 3.12"	39"	17,500 lb	3.68 lb
00831-315	00831-315S	3.13" to 3.74"	43"	18,000 lb	4.45 lb

## Power Cable Pulling Eyes

DCD power cable pulling eyes are all designed to offer the shortest possible overall length to help in travel over sheaves or bullwheels and are manufactured from high strength stainless steel. Three types are offered: a Swivel-Grip™, a Lug-style Power-Grip™, and a Clevis-style Power-Grip™.

The Swivel-Grip™ includes a built-in swivel head with load ratings always greater than the cable it is designed to pull. The two Power-Grip™ types do not have a built-in swivel, but are much shorter making bends and sheaves easier to traverse.

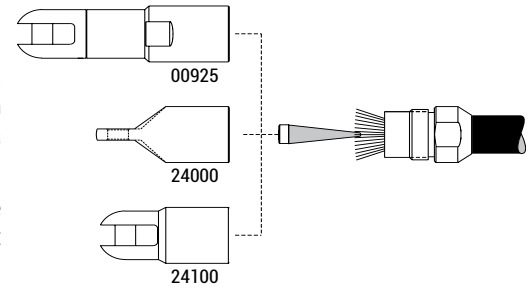

Grip is obtained by cutting away the cable jacket, feeding the core through the cone nut and driving the tapered insert into the cable core. The higher the load, the further the insert is drawn into the tapered bore and the firmer the grip becomes. The newly designed cone nuts feature a shortened thread making assembly and removal much quicker. Thorough testing proves that the grip obtained by this method is better than the strength of the cable itself. It is recommended that these pulling eyes be used only on cables with more than seven strand conductors. For cables with less than seven strands, use the Mini-Grip™ (24500 series).

## Swivel-Grip™

The Swivel-Grip™ pulling eye is reusable and has a built in swivel. It is constructed with all the features of the DCD Line Swivel (00505 series). The clevis head will attach directly onto a bridle sling or other pulling rope. Special cone nut sizes for compact cable are available on request.



Part No.	Maximum Cable Size	Maximum Core Diameter	Swivel-Grip Components							Threaded Cone Nut	Tapered Insert	Body	Fits Bridle Sling
			A	B	C	D	Weight						
00925-001	1/0 AWG	0.39" 9.9 mm	1-1/4" 32 mm	13/32" 10.3 mm	3/8" 9.5 mm	5-5/8" 143 mm	1.05 lb 0.47 kg	24006-001	24005-001	00926-001	1/4"		
00925-002	2/0 AWG	0.44" 11.1 mm	1-1/4" 32 mm	13/32" 10.3 mm	3/8" 9.5 mm	5-5/8" 143 mm	1.03 lb 0.46 kg	24006-002	24005-001	00926-001			
00925-003	3/0 AWG	0.50" 12.7 mm	1-1/4" 32 mm	13/32" 10.3 mm	3/8" 9.5 mm	5-5/8" 143 mm	1.08 lb 0.49 kg	24006-003	24005-001	00926-001			
00925-004	4/0 AWG	0.54" 13.7 mm	1-1/4" 32 mm	13/32" 10.3 mm	3/8" 9.5 mm	5-5/8" 143 mm	0.98 lb 0.44 kg	24006-004	24005-001	00926-001			
00925-025	250 MCM	0.61" 15.5 mm	1-1/4" 32 mm	13/32" 10.3 mm	3/8" 9.5 mm	5-5/8" 143 mm	0.93 lb 0.42 kg	24006-025	24005-001	00926-001			
00925-030	300 MCM	0.62" 15.7 mm	1-1/4" 32 mm	13/32" 10.3 mm	3/8" 9.5 mm	5-5/8" 143 mm	0.92 lb 0.42 kg	24006-030	24005-001	00926-001			
00925-035C	350 MCM Compact	0.65" 16.5 mm	1-7/8" 48 mm	11/16" 17.4 mm	5/8" 15.9 mm	7-1/8" 181 mm	3.34 lb 1.51 kg	24006-035C	24005-035	00926-035	1/4" & 3/8"		
00925-035	350 MCM	0.71" 18.0 mm	1-7/8" 48 mm	11/16" 17.4 mm	5/8" 15.9 mm	7-1/8" 181 mm	3.30 lb 1.49 kg	24006-035	24005-035	00926-035			
00925-050	500 MCM	0.81" 20.6 mm	1-7/8" 48 mm	11/16" 17.4 mm	5/8" 15.9 mm	7-1/8" 181 mm	3.20 lb 1.45 kg	24006-050	24005-035	00926-035			
00925-060	600 MCM	0.91" 23.1 mm	1-7/8" 48 mm	11/16" 17.4 mm	5/8" 15.9 mm	7-1/8" 181 mm	3.10 lb 1.41 kg	24006-060	24005-035	00926-035			
00925-070	700 MCM	0.97" 24.6 mm	2-1/8" 54 mm	25/32" 19.8 mm	11/16" 17.4 mm	8" 203 mm	4.70 lb 2.1 kg	24006-070	24005-070	00926-070	3/8" & 1/2"		
00925-075C	750 MCM Compact	0.94" 23.8 mm	2-1/8" 54 mm	25/32" 19.8 mm	11/16" 17.4 mm	8" 203 mm	4.90 lb 2.2 kg	24006-075C	24005-070	00926-070			
00925-075	750 MCM	1.00" 25.4 mm	2-1/8" 54 mm	25/32" 19.8 mm	11/16" 17.4 mm	8" 203 mm	4.70 lb 2.1 kg	24006-075	24005-070	00926-070			
00925-100C	1000 MCM Compact	1.03" 26.2 mm	2-1/8" 54 mm	25/32" 19.8 mm	11/16" 17.4 mm	8" 203 mm	4.40 lb 2.0 kg	24006-100C	24005-070	00926-070			
00925-100	1000 MCM	1.15" 29.2 mm	2-1/8" 54 mm	25/32" 19.8 mm	11/16" 17.4 mm	8" 203 mm	4.50 lb 2.0 kg	24006-100	24005-070	00926-070			

## Power-Grip™ (Lug)

The Power-Grip™ pulling eye is reusable and has a lug style head that will attach directly to a swivel. All materials are stainless steel. Only four body sizes are used to cover the range from 1/0 to 5000 MCM cable. Note that these pulling eyes should always be used with a Line Swivel (00505 series).



Part No.	Maximum Cable Size	Maximum Core Diameter	A	B	C	D	Weight	Power-Grip Components			Fits Line Swivels
								Threaded Cone Nut	Tapered Insert	Body	
24000-001	1/0 AWG	0.39" 9.9 mm	1-1/4" 32 mm	11/32" 8.7 mm	1/2" 13 mm	3-7/8" 98 mm	0.68 lb 0.30 kg	24006-001	24005-001	24007-001	
24000-002	2/0 AWG	0.44" 11.1 mm	1-1/4" 32 mm	11/32" 8.7 mm	1/2" 13 mm	3-7/8" 98 mm	0.67 lb 0.30 kg	24006-002	24005-001	24007-001	
24000-003	3/0 AWG	0.50" 12.7 mm	1-1/4" 32 mm	11/32" 8.7 mm	1/2" 13 mm	3-7/8" 98 mm	0.64 lb 0.29 kg	24006-003	24005-001	24007-001	00505-010 to 00505-027
24000-004	4/0 AWG	0.54" 13.7 mm	1-1/4" 32 mm	11/32" 8.7 mm	1/2" 13 mm	3-7/8" 98 mm	0.61 lb 0.27 kg	24006-004	24005-001	24007-001	
24000-025	250 MCM	0.61" 15.5 mm	1-1/4" 32 mm	11/32" 8.7 mm	1/2" 13 mm	3-7/8" 98 mm	0.58 lb 0.26 kg	24006-025	24005-001	24007-001	
24000-030	300 MCM	0.62" 15.7 mm	1-1/4" 32 mm	11/32" 8.7 mm	1/2" 13 mm	3-7/8" 98 mm	0.57 lb 0.26 kg	24006-030	24005-001	24007-001	
24000-035C	350 MCM Compact	0.65" 16.5 mm	1-7/8" 48 mm	3/8" 9.5 mm	5/8" 15.9 mm	4-3/4" 120 mm	1.88 lb 0.85 kg	24006-035C	24005-035	24007-035	
24000-035	350 MCM	0.71" 18.0 mm	1-7/8" 48 mm	3/8" 9.5 mm	5/8" 15.9 mm	4-3/4" 120 mm	1.84 lb 0.83 kg	24006-035	24005-035	24007-035	00505-015 to 00505-030
24000-050	500 MCM	0.81" 20.6 mm	1-7/8" 48 mm	3/8" 9.5 mm	5/8" 15.9 mm	4-3/4" 120 mm	1.75 lb 0.79 kg	24006-050	24005-035	24007-035	
24000-060	600 MCM	0.91" 23.1 mm	1-7/8" 48 mm	3/8" 9.5 mm	5/8" 15.9 mm	4-3/4" 120 mm	1.73 lb 0.79 kg	24006-060	24005-035	24007-035	
24000-070	700 MCM	0.97" 24.6 mm	2-1/8" 54 mm	1/2" 13 mm	13/16" 20.5 mm	5-5/8" 142 mm	2.55 lb 1.15 kg	24006-070	24005-070	24007-070	
24000-075C	750 MCM Compact	0.94" 23.8 mm	2-1/8" 54 mm	1/2" 13 mm	13/16" 20.5 mm	5-5/8" 142 mm	2.51 lb 1.14 kg	24006-075C	24005-070	24007-070	00505-020 to 00505-035
24000-075	750 MCM	1.00" 25.4 mm	2-1/8" 54 mm	1/2" 13 mm	13/16" 20.5 mm	5-5/8" 142 mm	2.47 lb 1.12 kg	24006-075	24005-070	24007-070	
24000-100C	1000 MCM Compact	1.03" 26.2 mm	2-1/8" 54 mm	1/2" 13 mm	13/16" 20.5 mm	5-5/8" 142 mm	2.40 lb 1.09 kg	24006-100C	24005-070	24007-070	
24000-100	1000 MCM	1.15" 29.2 mm	2-1/8" 54 mm	1/2" 13 mm	13/16" 20.5 mm	5-5/8" 142 mm	2.30 lb 1.04 kg	24006-100	24005-070	24007-070	
*24000-125	1250 MCM	1.29" 32.8 mm	2-3/4" 70 mm	3/4" 19 mm	1-1/32" 26 mm	7-15/16" 202 mm	6.37 lb 2.88 kg	24006-125	24005-125	24007-125	
*24000-150	1500 MCM	1.41" 35.8 mm	2-3/4" 70 mm	3/4" 19 mm	1-1/32" 26 mm	7-15/16" 202 mm	6.13 lb 2.78 kg	24006-150	24005-125	24007-125	
*24000-175	1750 MCM	1.53" 38.9 mm	2-3/4" 70 mm	3/4" 19 mm	1-1/32" 26 mm	7-15/16" 202 mm	5.84 lb 2.64 kg	24006-175	24005-125	24007-125	00505-035 to 00505-041
*24000-200	2000 MCM	1.63" 41.4 mm	2-3/4" 70 mm	3/4" 19 mm	1-1/32" 26 mm	7-15/16" 202 mm	5.53 lb 2.50 kg	24006-200	24005-125	24007-125	
*24000-200C	2000 MCM Compact	1.75" 44.5 mm	2-3/4" 70 mm	3/4" 19 mm	1-1/32" 26 mm	7-15/16" 202 mm	5.40 lb 2.45 kg	24006-200C	24005-125	24007-125	
*24000-300	3000 MCM	1.85" 47.0 mm	2-3/4" 70 mm	3/4" 19 mm	1-1/32" 26 mm	6-25/32" 172 mm	4.64 lb 2.11 kg	24006-200	24005-125	24007-125	
*24000-300C	1800 mm <sup>2</sup>	2.06" 52.4 mm	4-1/2" 114 mm	1" 25 mm	1-3/4" 44.5 mm	11-11/16" 297 mm	25.8 lb 11.7 kg	24006-300C	24005-500	24007-500	00505-045 & 00505-050
*24000-400	4000 MCM	2.41" 61.2 mm	4-1/2" 114 mm	1" 25 mm	1-3/4" 44.5 mm	11-11/16" 297 mm	23.7 lb 10.8 kg	24006-400	24005-500	24007-500	
*24000-500	5000 MCM	2.52" 64.0 mm	4-1/2" 114 mm	1" 25 mm	1-3/4" 44.5 mm	11-11/16" 297 mm	23.7 lb 10.8 kg	24006-500	24005-500	24007-500	

Note: Additional sizes are available upon request. Please contact Customer Service for more information.

\* Larger Power-Grips are machined from alloy steel and plated.

## Power-Grip™ (Clevis)

The Power-Grip™ pulling eye is reusable and has a clevis style head that will attach directly over the looped ends of the bridle slings or other pulling attachments. All materials are stainless steel. Only four body sizes are used to cover the range from 1/0 to 2000 MCM cable. Note that these pulling eyes should always be used with a Line Swivel (00505 series).

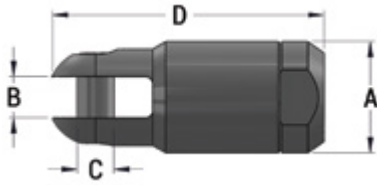

Part No.	Maximum Cable Size	Maximum Core Diameter	A	B	C	D	Weight	Power-Grip Components			Fits Bridle Sling
								Threaded Cone Nut	Tapered Insert	Body	
24100-001	1/0 AWG	0.39" 9.9 mm	1-1/4" 32 mm	13/32" 10.3 mm	3/8" 9.5 mm	3-5/8" 92 mm	0.68 lb 0.30 kg	24006-001	24005-001	24008-001	1/4"
24100-002	2/0 AWG	0.44" 11.1 mm	1-1/4" 32 mm	13/32" 10.3 mm	3/8" 9.5 mm	3-5/8" 92 mm	0.67 lb 0.30 kg	24006-002	24005-001	24008-001	
24100-003	3/0 AWG	0.50" 12.7 mm	1-1/4" 32 mm	13/32" 10.3 mm	3/8" 9.5 mm	3-5/8" 92 mm	0.64 lb 0.29 kg	24006-003	24005-001	24008-001	
24100-004	4/0 AWG	0.54" 13.7 mm	1-1/4" 32 mm	13/32" 10.3 mm	3/8" 9.5 mm	3-5/8" 92 mm	0.61 lb 0.27 kg	24006-004	24005-001	24008-001	
24100-025	250 MCM	0.61" 15.5 mm	1-1/4" 32 mm	13/32" 10.3 mm	3/8" 9.5 mm	3-5/8" 92 mm	0.58 lb 0.26 kg	24006-025	24005-001	24008-001	1/4" & 3/8"
24100-030	300 MCM	0.62" 15.7 mm	1-1/4" 32 mm	13/32" 10.3 mm	3/8" 9.5 mm	3-5/8" 92 mm	0.57 lb 0.26 kg	24006-030	24005-001	24008-001	
24100-035C	350 MCM Compact	0.65" 16.5 mm	1-7/8" 48 mm	3/8" 9.5 mm	5/8" 15.9 mm	4-5/8" 117 mm	1.94 lb 0.88 kg	24006-035C	24005-035	24008-035	
24100-035	350 MCM	0.71" 18.0 mm	1-7/8" 48 mm	3/8" 9.5 mm	5/8" 15.9 mm	4-5/8" 117 mm	1.90 lb 0.86 kg	24006-035	24005-035	24008-035	
24100-050	500 MCM	0.81" 20.6 mm	1-7/8" 48 mm	3/8" 9.5 mm	5/8" 15.9 mm	4-5/8" 117 mm	1.80 lb 0.81 kg	24006-050	24005-035	24008-035	3/8" & 1/2"
24100-060	600 MCM	0.91" 23.1 mm	1-7/8" 48 mm	3/8" 9.5 mm	5/8" 15.9 mm	4-5/8" 117 mm	1.80 lb 0.81 kg	24006-060	24005-035	24008-035	
24100-070	700 MCM	0.97" 24.6 mm	2-1/8" 54 mm	25/32" 19.8 mm	11/16" 17.5 mm	5-1/4" 133 mm	2.90 lb 1.3 kg	24006-070	24005-070	24008-070	
24100-075C	750 MCM Compact	0.94" 23.8 mm	2-1/8" 54 mm	25/32" 19.8 mm	11/16" 17.5 mm	5-1/4" 133 mm	2.80 lb 1.2 kg	24006-075C	24005-070	24008-070	
24100-075	750 MCM	1.00" 25.4 mm	2-1/8" 54 mm	25/32" 19.8 mm	11/16" 17.5 mm	5-1/4" 133 mm	2.70 lb 1.2 kg	24006-075	24005-070	24008-070	3/8" & 1/2"
24100-100C	1000 MCM Compact	1.03" 26.2 mm	2-1/8" 54 mm	25/32" 19.8 mm	11/16" 17.5 mm	5-1/4" 133 mm	2.60 lb 1.18 kg	24006-100C	24005-070	24008-070	
24100-100	1000 MCM	1.15" 29.2 mm	2-1/8" 54 mm	25/32" 19.8 mm	11/16" 17.5 mm	5-1/4" 133 mm	2.50 lb 1.1 kg	24006-100	24005-070	24008-070	
*24100-125	1250 MCM	1.29" 32.8 mm	2-3/4" 70 mm	1" 25.4 mm	7/8" 22.2 mm	7-1/4" 184 mm	6.70 lb 3.0 kg	24006-125	24005-125	24008-125	
*24100-150	1500 MCM	1.41" 35.8 mm	2-3/4" 70 mm	1" 25.4 mm	7/8" 22.2 mm	7-1/4" 184 mm	6.40 lb 2.9 kg	24006-150	24005-125	24008-125	3/8" & 1/2"
*24100-175	1750 MCM	1.53" 38.9 mm	2-3/4" 70 mm	1" 25.4 mm	7/8" 22.2 mm	7-1/4" 184 mm	6.20 lb 2.8 kg	24006-175	24005-125	24008-125	
*24100-200	2000 MCM	1.63" 41.4 mm	2-3/4" 70 mm	1" 25.4 mm	7/8" 22.2 mm	7-1/4" 184 mm	5.90 lb 2.6 kg	24006-200	24005-125	24008-125	
*24100-200C	2000 MCM Compact	1.75" 44.5 mm	2-3/4" 70 mm	1" 25.4 mm	7/8" 22.2 mm	7-1/4" 184 mm	4.70 lb 2.14 kg	24006-200C	24005-125	24008-125	

\* Larger Power-Grips are machined from alloy steel and plated.



## Custom Kits

Many contractors have requested custom kits that combine an arrangement of Power-Grips that can be used for pulling multiple sizes of cables. Threaded Cone Nuts and Tapered Inserts are common between some sizes, and the kits take advantage of this and provide usage for a range of cable sizes with the least number of components, making the kits economical as well.

The kits are available in the Power-Grip (Lug), Swivel-Grip, and Power-Grip (Clevis) styles, with or without Bridle Slings (23000 series). Shown is a special kit designed for a major mid-west contractor. Their requirement was to pull up to three cables of various different sizes.

DCD custom designs foam inserts to fit into a metal carrying box or even this large, durable plastic tow-around case. This keeps the products clean, organized and secure. It is also easy to see if any parts are missing.

Choose from the pre-arranged kits listed or contact Customer Service for options in creating a custom kit most suitable for your operation.



Kit Styles 1 & 2



Kit Style 3

## Kit Style 1 - Sizes Included: 1/0 AWG, 4/0 AWG, 250 MCM, 350 MCM, 500 MCM

00925-KT1 Contents	24000-KT1 Contents	24100-KT1 Contents	Quantity	Description	Body Diameter	Maximum Core Diameter
00926-001	24007-001	24008-001	3	Swivel-Grip/Pulling Eye Body 1/0 AWG - 250 MCM	1-1/4"	-
24006-001	24006-001	24006-001	3	Threaded Cone Nut 1/0 AWG	-	0.39"
24006-004	24006-004	24006-004	3	Threaded Cone Nut 4/0 AWG	-	0.54"
24006-025	24006-025	24006-025	3	Threaded Cone Nut 250 MCM	-	0.61"
24005-001	24005-001	24005-001	6	Tapered Insert 1/0 AWG - 250 MCM	-	-
00926-035	24007-035	24008-035	3	Swivel-Grip/Pulling Eye Body 350 - 500 MCM	1-7/8"	-
24006-035	24006-035	24006-035	3	Threaded Cone Nut 350 MCM	-	0.71"
24006-050	24006-050	24006-050	3	Threaded Cone Nut 500 MCM	-	0.81"
24005-001	24005-001	24005-001	6	Tapered Insert 1/0 AWG - 250 MCM	-	-
24005-035	24005-035	24005-035	6	Tapered Insert 350 - 500 MCM	-	-
00101-250	00101-250	00101-250	1	Allen Key 1/4" Long Arm	-	-
00101-375	00101-375	00101-375	1	Allen Key 3/8" Long Arm	-	-
93106-015	93106-015	93106-015	1	Foam Insert	-	-
93100-009	93100-009	93100-009	1	Tool Box (7" L x 19" W x 7-1/2" H)	-	-

## Kit Style 2 - Sizes Included: 350 MCM, 500 MCM, 700 MCM, 750 MCM, 1000 MCM

00925-KT2 Contents	24000-KT2 Contents	24100-KT2 Contents	Quantity	Description	Body Diameter	Maximum Core Diameter
00926-035	24007-035	24008-035	3	Swivel-Grip/Pulling Eye Body 350 - 500 MCM	1-7/8"	-
24006-035	24006-035	24006-035	3	Threaded Cone Nut 350 MCM	-	0.71"
24006-050	24006-050	24006-050	3	Threaded Cone Nut 500 MCM	-	0.81"
24005-035	24005-035	24005-035	6	Tapered Insert 350 - 500 MCM	-	-
00926-070	24007-070	24008-070	3	Swivel-Grip/Pulling Eye Body 700 - 1000 MCM	2-1/8"	-
24006-070	24006-070	24006-070	3	Threaded Cone Nut 500 MCM	-	0.97"
24006-075	24006-075	24006-075	3	Threaded Cone Nut 750 MCM	-	1.00"
24006-100	24006-100	24006-100	3	Threaded Cone Nut 1000 MCM	-	1.15"
24005-070	24005-070	24005-070	6	Tapered Insert 700 - 1000 MCM	-	-
00101-250	00101-250	00101-250	1	Allen Key 1/4" Long Arm	-	-
00101-375S	00101-375S	00101-375S	1	Allen Key 3/8" Long Arm	-	-
93106-021	93106-021	93106-021	1	Foam Insert	-	-
93100-012	93100-012	93100-012	1	Tool Box (8" L x 24" W x 9" H)	-	-

## Kit Style 3 - Size Range: 1/0 AWG to 1000 MCM (excludes 300 MCM)

00925-KT3 Contents	24000-KT3 Contents	24100-KT3 Contents	Quantity	Description	Body Diameter	Maximum Core Diameter
00926-001	24007-001	24008-001	3	Swivel-Grip/Pulling Eye Body 1/0 AWG - 250 MCM	1-1/4"	-
24006-001	24006-001	24006-001	3	Threaded Cone Nut 1/0 AWG	-	0.39"
24006-002	24006-002	24006-002	3	Threaded Cone Nut 2/0 AWG	-	0.44"
24006-003	24006-003	24006-003	3	Threaded Cone Nut 3/0 AWG	-	0.50"
24006-004	24006-004	24006-004	3	Threaded Cone Nut 4/0 AWG	-	0.54"
24006-025	24006-025	24006-025	3	Threaded Cone Nut 250 MCM	-	0.61"
24005-001	24005-001	24005-001	15	Tapered Insert 1/0 AWG - 250 MCM	-	-
00926-035	24007-035	24008-035	3	Swivel-Grip/Pulling Eye Body 350 - 500 MCM	1-7/8"	-
24006-035	24006-035	24006-035	3	Threaded Cone Nut 350 MCM	-	0.71"
24006-050	24006-050	24006-050	3	Threaded Cone Nut 500 MCM	-	0.81"
24005-035	24005-035	24005-035	6	Tapered Insert 350 - 500 MCM	-	-
00926-070	24007-070	24008-070	3	Swivel-Grip/Pulling Eye Body 700 - 1000 MCM	2-1/8"	-
24006-070	24006-070	24006-070	3	Threaded Cone Nut 700 MCM	-	0.97"
24006-075	24006-075	24006-075	3	Threaded Cone Nut 750 MCM	-	1.00"
24006-100	24006-100	24006-100	3	Threaded Cone Nut 1000 MCM	-	1.15"
24005-070	24005-070	24005-070	9	Tapered Insert 700 - 1000 MCM	-	-
00101-250	00101-250	00101-250	1	Allen Key 1/4" Long Arm	-	-
00101-375	00101-375	00101-375	1	Allen Key 3/8" Long Arm	-	-
93106-019	93106-019	93106-019	1	Foam Insert	-	-
61722-002	61722-002	61722-002	1	Chest (19-1/2" L 25" W X 12" H)	-	-



## Multiplex Pushing Eye

This product is designed to be threaded onto the lead end of a group of either triplex or quadplex cables so that they can be pushed through short lengths of ducting. The basic pushing eye comes with only the body and a shoulder bolt. There are several different attachments which can be threaded onto the bolt and these must be purchased separately.

These include some of the accessories used with our duct rodders such as the pulling eye, the clevis end and the roller guide as well as a standard eye nut. Any of these can act as a leader for the pushing eye.

Each size of pushing eye can be used to attach to different groups of cable. Because the cables can be in different quantities and diameters, the range for each pushing eye is determined by the diameter around the group of cables. This information is available on the data supplied by the cable manufacturer or it can be measured using the diagram below as a guide.

The 24200-KT1 is a kit comprising one of each size of pushing eye plus one each of the leaders shown in the photograph.

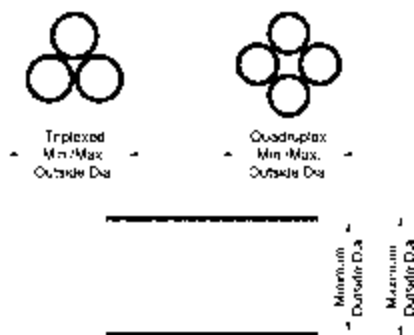

Part No.	Minimum Outside Cable Diameter	Maximum Outside Cable Diameter	Weight
24200-010	1.00"	1.22"	0.63 lb
24200-020	1.22"	1.41"	0.67 lb
24200-030	1.41"	1.59"	0.73 lb
24200-KT1	1.00"	1.59"	2.20 lb

Part No.	Leader Attachments
57150-004	Roller Guide
57160-004	Clevis End
57120-004	Pulling Eye
90024-037	Eye Nut

## Multiplex Pulling Eye

This stainless steel product is designed to pull either triplex or quadplex cables. The four holes are sized for the cable conductors and each hole has three setscrews to clamp down on the cable. Each product is also supplied with three spare set screws and a hex key.

Care needs to be taken pulling around bends or sheaves because there will be extra heavy load on the cables on the outside of the bend and this may cause them to pull loose from their clamped position in the pulling eye.

Use mainly for short, straight pulls.

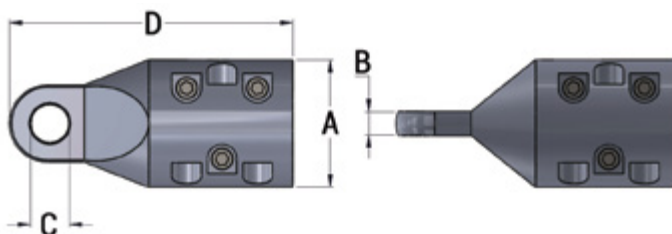

Part No.	Maximum Cable Size	Maximum Core Size	A	B	C	D	Weight	Use with Line Swivel
24300-001	1/0 AWG	0.437"	1-3/4"	3/8"	5/8"	4-15/16"	1.4 lb	00505-015 to 00505-030
24300-004	4/0 AWG	0.593"	2-1/4"	3/8"	5/8"	4-15/16"	2.5 lb	
24300-350	350 MCM	0.750"	2-11/16"	1/2"	13/16"	6"	4.1 lb	00505-020 to 00505-035
24300-500	500 MCM	0.875"	2-7/8"	1/2"	13/16"	6-1/8"	4.5 lb	

## Mini-Grip™

The Mini-Grip™ pulling eye is reusable and has a lug style head that will attach directly into a line swivel or other type of connector. This pulling eye is zinc plated for corrosion and has three set screws that clamp directly onto the cable conductor. It is suitable for smaller cables with conductors having seven strands or less.

Note: These pulling eyes should always be used with a Line Swivel (00505 series).



Part No.	Maximum Cable Size	Maximum Core Diameter	Body Diameter	Weight
24500-343	4 to 3 AWG	0.33"	3/4"	0.30 lb
24500-406	2 to 1/0 AWG	0.39"	7/8"	0.37 lb
24500-562	2/0 to 4/0 AWG	0.55"	1"	0.44 lb

## Pulling Harness

The purpose of this product is to allow single or multiple pulls at one time by attaching one or two cables to the one pulling harness. The harness legs are manufactured from aircraft quality galvanized wire rope while the connector end is manufactured from stainless steel.

The two leg units are staggered in length so the individual connections are not interfering with each other. The safety factor is based on equal pull on both legs.

The double leg harness is available in long or short configurations and each is supplied with one hex key and four set screws. The single harness is supplied with one hex key and two set screws. Both the hex key and the set screws are available separately.

Cable sizes that can be pulled with these harnesses are 2/0 to 4/0 AWG.

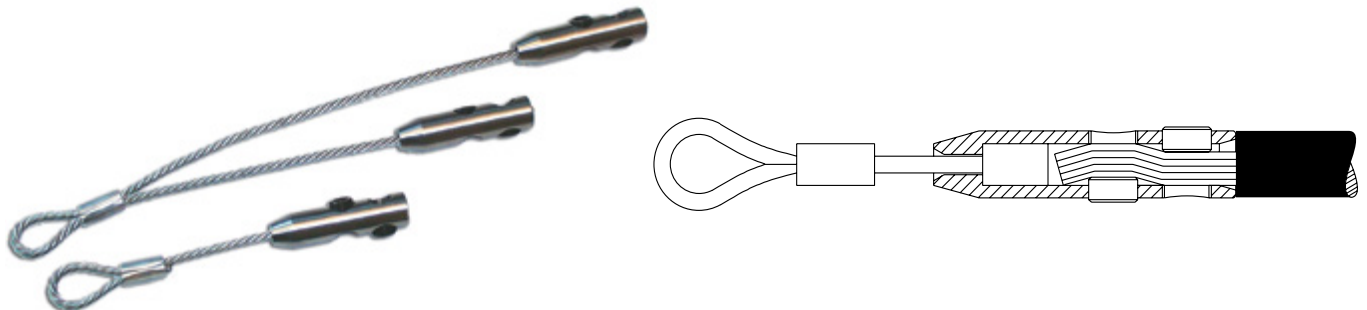

Part No.	Description	Wire Diameter	Number of Legs	3:1 Safe Working Load Leg Capacity	3:1 Safe Working Load Total Capacity	Weight
25000-010	Single Leg	1/4"	1	2,300 lb	2,300 lb	1.00 lb
25000-020	Double Leg - Short	1/4"	2	2,300 lb	4,600 lb	1.70 lb
25000-021	Double Leg - Long	1/4"	2	2,300 lb	4,600 lb	2.00 lb
90000-166	Set Screw	-	-	-	-	0.10 lb
00101-375	Hex Key	-	-	-	-	0.28 lb



## Innerduct Pulling Eyes

These products are designed to install polyethylene ducting using a screw-in tapered thread to grip the inside diameter of the duct. The pulling eyes are typically used to install innerduct inside a larger duct. However, the 00604 and 00605 series may also be used for directional drilling applications and because there are no moving parts, they are reliable and maintenance free.

All of these pulling eyes are designed with cutting edges to actually cut a thread in the bore of the ducting as it is being screwed in, much the same way as using a tap to cut a thread in steel. This helps to ensure a reliable grip. Installation typically requires only seven or eight full threads of contact to give a grip stronger than the ducting itself.

The pulling eyes are installed quickly and easily and require no special tooling. They are manufactured out of steel and plated for durability and corrosion resistance.



## Lug Style Pulling Eye

The lug style is recommended when attaching directly to a Line Swivel (00505 series) or other clevis type connector.

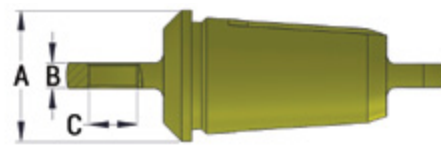

Part No.	Nominal Duct Size	Minimum Duct Inside Diameter	Maximum Duct Inside Diameter	A	B	C	Weight
00604-050	1/2"	0.47"	0.65"	7/8"	5/16"	7/16"	0.23 lb
00604-075	3/4"	0.72"	0.93"	1-1/8"	11/32"	17/32"	0.51 lb
00604-100	1"	0.94"	1.15"	1-3/8"	11/32"	21/32"	0.79 lb
00604-113	1-1/4"	1.15"	1.34"	1-1/2"	11/32"	21/32"	1.16 lb
00604-125	1-1/4"	1.26"	1.44"	1-3/4"	11/32"	21/32"	1.40 lb
00604-150	1-1/2"	1.48"	1.66"	2"	1/2"	15/16"	2.03 lb
00604-175	1-3/4"	1.66"	1.81"	2-1/4"	1/2"	15/16"	2.48 lb
00604-200	2"	1.91"	2.08"	2-1/2"	1/2"	15/16"	3.20 lb
00604-250	2-1/2"	2.41"	2.58"	3"	1/2"	15/16"	5.66 lb
00604-KT1	Kit including one each of the following 00604 part numbers: -075, -100, -113, -125, -150, -175, -200						
00604-010	Driving Tool for Lug Style Pulling Eyes (with 1/2" square drive)						

## Clevis Style Pulling Eye

The clevis style pulling eyes are better if attaching to a pulling rope or wire with an eye that can be slotted into the clevis and simply attached with the pin provided.

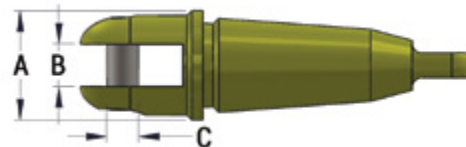

Part No.	Nominal Duct Size	Minimum Duct Inside Diameter	Maximum Duct Inside Diameter	A	B	C	Weight
00605-100	1"	0.94"	1.15"	1-3/8"	17/32"	13/32"	0.90 lb
00605-125	1-1/4"	1.26"	1.44"	1-3/4"	17/32"	13/32"	1.48 lb
00605-150	1-1/2"	1.48"	1.66"	2"	11/16"	5/8"	2.20 lb
00605-200	2"	1.91"	2.08"	2-1/2"	11/16"	5/8"	3.35 lb

## Swivel Clevis Style Pulling Eye

These products are similar to the 00604 and 00605 series, but incorporate a built-in swivel head. They should only be used to install innerduct and are not suitable for use in any kind of directional drilling application.



Part No.	Nominal Duct Size	Minimum Duct Inside Diameter	Maximum Duct Inside Diameter	A	B	C	Weight
00615-100	1"	0.94"	1.15"	1-1/4"	17/32"	13/32"	0.99 lb
00615-125	1-1/4"	1.26"	1.44"	1-5/8"	17/32"	13/32"	1.57 lb
00615-150	1-1/2"	1.48"	1.66"	1-3/4"	11/16"	5/8"	2.23 lb
00615-200	2"	1.91"	2.08"	2-1/4"	11/16"	5/8"	3.51 lb

## Vibratory Plow-Grip

This product is specifically designed for installation of PVC or PE duct by vibratory plow and is particularly suited to agricultural applications because of its quick installation and removal.

DCD Plow-Grips are comprised of a stainless steel body and a clevis head with eight links of hardened steel chain attached and hardened stainless steel expanding jaws with teeth that grip the inside of the ducting.



Since there are various outside and inside diameters for ducting, the DCD plow grip now has a single sleeve with a different bore size at each end. Should your ducting not fit at one end, reverse the sleeve and check the other end. The two sleeve sizes will cover 80 lb and 100 lb PE duct and Schedule 40 up to SDR 26 PVC duct as well as CSA B137.1 PE duct.

To assemble the Plow-Grip to the ducting, the head is pushed against a spring which contracts the hardened steel jaws. The Plow-Grip can then be sleeved over the ducting. When the head is released, the jaws expand inside the duct and bite into the duct wall. As the pulling load is applied, it increases the bite of the jaws. When the pull is complete, pushing the head down will again contract the jaws allowing the Plow-Grip to be removed from the ducting.

Part No.	Nominal Pipe Size	Minimum Duct Inside Diameter	Maximum Duct Inside Diameter	Maximum Duct Outside Diameter	Weight
00600-075	3/4"	0.82"	0.97"	1.060"	1.50 lb
00600-100	1"	1.05"	1.22"	1.325"	2.20 lb
00600-125	1-1/4"	1.38"	1.54"	1.670"	3.20 lb
00600-150	1-1/2"	1.50"	1.70"	2.000"	6.54 lb
00600-200	2"	1.95"	2.38"	2.658"	9.10 lb

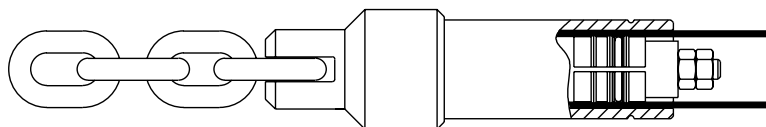

The main appeal of this product is the extreme ease of attaching the product to the ducting. This can easily be done in just a few seconds and no tools are required.

Typical vibratory plow action causes a very fine dust or powder to surround the puller, it is recommended that the user periodically dismantle the product for thorough cleaning. A wrench is the only tool required for complete dismantling.

# Duct Installation & Proofing

## Pest Duct Puller

The Pest Duct Puller is specifically sized for pulling Dura-Line® HDPE steel armor conduit. The duct puller pulls, seals (tested to over 60 psi), and prevents the duct from stretching or the layers separating by utilizing the outer body in combination with the expanding jaws. This design also features a full size rear eye nut for back loads.



Part No.	Nominal Duct Diameter	3:1 Safe Working Load	Rear Eye Capacity (3:1 SWL)	Minimum Inside Duct Diameter	Maximum Inside Duct Diameter	Duct Insertion Depth	Weight
<b>C2012-125</b>	1-1/4"	3,600 lb	1,000 lb	1.35" / 34.2 mm	1.60" / 40.6 mm	1.2"	2.2 lb

Note: Safe Working Load is based on the duct yield strength to protect from creep failure.

## Expanding Duct Puller - 00616 Series

The 00616/00617 series pullers were designed based on the older 00619 series pullers. After a customer request for a easier to handle puller we created a puller with a steel face plate instead of polyurethane. This design change has been made to satisfy customer request. As with the 00619 series, these pullers are designed with a larger expansion range in each unit as compared to the 00620 series.



The puller comes standard with a duct plugger installed and complete with a rear pulling eye. Standard duct sleeves (00625 series) can also be used with this product.

Part No.	Nominal Duct Size	3:1 Safe Working Load	Rear Eye Capacity (3:1 SWL)	Minimum Inside Duct Diameter	Maximum Inside Duct Diameter	Weight	Duct Sleeve Part No.
<b>00616-125</b>	1-1/4"	4,300 lb	1,100 lb	1.280" / 32.5 mm	1.610" / 40.9 mm	1.3 lb	<b>00625-125</b>
<b>00616-150</b>	1-1/2"	4,300 lb	1,100 lb	1.437" / 36.5 mm	1.812" / 46.0 mm	1.5 lb	<b>00625-150</b>
<b>00616-200</b>	2"	8,600 lb	1,300 lb	1.813" / 46.0 mm	2.188" / 55.6 mm	3.2 lb	<b>00625-200</b>
<b>00616-250</b>	2-1/2"	8,600 lb	1,300 lb	2.188" / 55.6 mm	2.625" / 66.7 mm	4.5 lb	<b>00625-250</b>
<b>00616-300</b>	3"	8,600 lb	1,300 lb	2.688" / 68.3 mm	3.125" / 79.4 mm	5.7 lb	<b>00625-300</b>
<b>00616-400</b>	4"	12,000 lb	3,750 lb	3.313" / 84.1 mm	4.063" / 103.2 mm	14.6 lb	<b>00625-400</b>
<b>00616-500</b>	5"	12,000 lb	3,750 lb	4.250" / 108.0 mm	5.063" / 128.6 mm	24.5 lb	<b>00625-500</b>
<b>00616-600</b>	6"	22,100 lb	5,100 lb	4.875" / 123.8 mm	6.187" / 157.1 mm	47.9 lb	<b>00625-600</b>

Note: Safe Working Load is based on the duct yield strength to protect from creep failure.

## Metric Version

00617 Duct Pullers are the same as the 00616 series, but are designed with jaws that allow sizing to metric duct sizes. These Pullers are made to order.

Part No.	Nominal Duct Size	3:1 Safe Working Load	Rear Eye Capacity (3:1 SWL)	Minimum Inside Duct Diameter	Maximum Inside Duct Diameter	Weight	Duct Sleeve Part No.
<b>00617-040</b>	40 mm	19.1 kN	4.9 kN	1.280" / 32.5 mm	1.610" / 40.9 mm	0.55 kg	<b>00626-040</b>
<b>00617-050</b>	50 mm	19.1 kN	4.9 kN	1.437" / 36.5 mm	1.812" / 46.0 mm	0.68 kg	<b>00626-050</b>
<b>00617-063</b>	63 mm	38.2 kN	5.8 kN	1.800" / 45.7 mm	2.250" / 57.1 mm	1.5 kg	<b>00626-063</b>
<b>00617-075</b>	75 mm	38.2 kN	5.8 kN	2.188" / 55.6 mm	2.593" / 65.8 mm	1.9 kg	<b>00626-075</b>
<b>00617-090</b>	90 mm	38.2 kN	5.8 kN	2.688" / 68.3 mm	3.125" / 79.4 mm	2.3 kg	<b>00626-090</b>
<b>00617-110</b>	110 mm	53.3 kN	16.7 kN	3.313" / 84.1 mm	4.031" / 102.4 mm	6.0 kg	<b>00626-110</b>
<b>00617-125</b>	125 mm	53.3 kN	22.7 kN	3.770" / 95.7 mm	4.500" / 114.3 mm	7.1 kg	<b>00626-125</b>
<b>00617-140</b>	140 mm	53.3 kN	22.7 kN	4.219" / 107.2 mm	5.063" / 128.6 mm	8.9 kg	<b>00626-140</b>
<b>00617-160</b>	160 mm	98.3 kN	22.7 kN	4.875" / 123.8 mm	6.219" / 157.9 mm	18.8 kg	<b>00626-160</b>

Note: Safe Working Load is based on the duct yield strength to protect from creep failure.

## Expanding Duct Puller - 00620 Series

These products are designed to grip polyethylene ducting using expanding jaws to grip the inside wall of the duct. This causes the pulling load to be spread around the circumference of the duct and allows a maximum load to be applied without damage to the ducting.

Care should be taken at all times not to exceed the yield value of the ducting since this may cause permanent deformation to the duct as well as loss to the integrity of the polyethylene.

On thin wall ducting, it is recommended that an outer duct sleeve be used to prevent the duct stretching during installation. A firmer and more stable grip will also be obtained when this is done. Use of a duct plugger will help to prevent mud and slurry from entering past the puller into the ducting. Duct wall thickness is normally designated by an SDR value. The lower the SDR value, the heavier the wall thickness. These products can be used on SDR 11 through SDR 17 ducting.

When ordering 10" and 12" Expanding Duct Pullers, the inside diameter of the duct must be known in order to select the correct duct puller part number. Jaw sets are easily interchangeable in the 10" and 12" size pullers. Alternate jaw sets for different SDR values can be purchased separately.

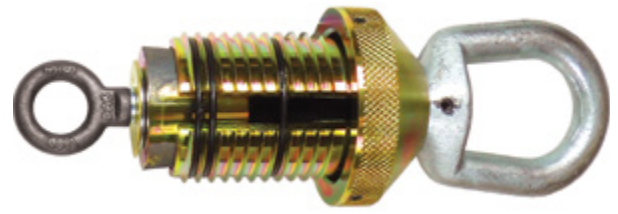

Part No.	Nominal Duct Size	3:1 Safe Working Load	Rear Eye Capacity (3:1 SWL)	Minimum Inside Duct Diameter	Maximum Inside Duct Diameter	Weight	Duct Sleeve Part No.	Duct Plugger Part No.	Jaws Set Part No.
00620-125	1-1/4"	3,750 lb	1,000 lb	1.281" / 32.5 mm	1.500" / 38.1 mm	1.5 lb	00625-125	00630-125	-
00620-150	1-1/2"	3,750 lb	1,000 lb	1.469" / 36.5 mm	1.688" / 42.9 mm	1.7 lb	00625-150	00630-150	-
00620-200	2"	6,000 lb	1,500 lb	1.875" / 47.6 mm	2.125" / 54.0 mm	3.0 lb	00625-200	00630-200	-
00620-250	2-1/2"	6,000 lb	1,500 lb	2.250" / 57.2 mm	2.500" / 63.5 mm	5.0 lb	00625-250	00630-250	-
00620-300	3"	12,000 lb	2,500 lb	2.750" / 69.9 mm	3.063" / 77.8 mm	8.5 lb	00625-300	00630-300	-
00620-400	4"	12,000 lb	2,500 lb	3.500" / 88.9 mm	4.063" / 103.2 mm	15.0 lb	00625-400	00630-400	-
00620-500	5"	25,500 lb	4,250 lb	4.500" / 114.3 mm	5.000" / 127.0 mm	32.0 lb	00625-500	00630-500	-
00620-600	6"	25,500 lb	4,250 lb	5.438" / 138.1 mm	6.125" / 155.6 mm	48.0 lb	00625-600	00630-600	-
00620-800	8"	37,000 lb	12,000 lb	6.708" / 170.4 mm	7.875" / 200.0 mm	88.0 lb	-	00630-800	-
00620-1009*	10" SDR 9	42,000 lb	12,000 lb	7.938" / 201.6 mm	8.625" / 219.1 mm	135.0 lb	-	-	00622-1009
00620-1011*	10" SDR 11	30,000 lb	12,000 lb	8.375" / 212.7 mm	9.063" / 230.2 mm	137.0 lb	-	-	00622-1011
00620-1017*	10" SDR 17	42,000 lb	12,000 lb	9.063" / 230.2 mm	9.750" / 247.7 mm	142.0 lb	-	00630-1017	00622-1017
00620-1209*	12" SDR 9	30,000 lb	12,000 lb	9.563" / 242.9 mm	10.250" / 260.4 mm	190.0 lb	-	-	00622-1209
00620-1211*	12" SDR 11	42,000 lb	12,000 lb	10.063" / 255.6 mm	10.750" / 273.1 mm	203.0 lb	-	-	00622-1211
00620-1217*	12" SDR 17	125,000 lb	12,000 lb	10.938" / 277.8 mm	11.563" / 293.7 mm	223.0 lb	-	-	00622-1217

\* May be ordered separately, without jaws.

Note: Safe Working Load is based on the duct yield strength to protect from creep failure.

## Metric Version

These Duct Pullers are the same as the 00620 series, but are designed with jaws that allow sizing to metric duct sizes.

Part No.	Nominal Duct Size	3:1 Safe Working Load	Rear Eye Capacity (3:1 SWL)	Minimum Inside Duct Diameter	Maximum Inside Duct Diameter	Weight	Duct Sleeve Part No.	Duct Plugger Part No.
00621-040	40 mm	16.6 kN	4.8 kN	1.260" / 32.0 mm	1.496" / 38.0 mm	0.73 kg	00626-040	00631-040
00621-063	63 mm	26.6 kN	6.6 kN	2.000" / 50.8 mm	2.248" / 57.1 mm	1.36 kg	00626-063	00631-063
00621-075	75 mm	26.6 kN	6.6 kN	2.374" / 60.3 mm	2.626" / 66.7 mm	2.2 kg	00626-075	00631-075
00621-090	90 mm	53.3 kN	11.4 kN	2.874" / 73.0 mm	3.189" / 81.0 mm	4.0 kg	00626-090	00631-090
00621-110	110 mm	53.3 kN	11.4 kN	3.374" / 85.7 mm	3.937" / 100.0 mm	6.6 kg	00626-110	00631-110
00621-125	125 mm	113.4 kN	19.2 kN	3.890" / 98.8 mm	4.388" / 111.5 mm	14.3 kg	00626-125	00631-125
00621-140	140 mm	113.4 kN	19.2 kN	4.488" / 114.0 mm	5.000" / 127.0 mm	14.3 kg	00626-140	00631-140
00621-160	160 mm	113.4 kN	19.2 kN	4.937" / 125.4 mm	5.626" / 142.9 mm	22.0 kg	00626-160	00631-160
00621-180	180 mm	113.4 kN	19.2 kN	5.689" / 144.5 mm	6.378" / 162.0 mm	22.0 kg	-	00631-180
00621-200	200 mm	164.5 kN	53.3 kN	6.708" / 170.4 mm	7.874" / 200.0 mm	40.8 kg	-	00631-200

Note: Safe Working Load is based on the duct yield strength to protect from creep failure.



## Sealed Duct Puller

These products are designed to install polyethylene ducting using expanding jaws to grip the inside diameter of the duct while the outside diameter is prevented from stretching by a permanent outer sleeve on the puller. The outer sleeve also provides a complete seal around the ducting preventing any fluids or contaminants from entering either the duct or the pulling eye.

The pulling head is manufactured from alloy steel and is designed to protect the mechanism from heavy knocks or side loads. It is also fully sealed to prevent any fluid entry.



Care should be taken at all times not to exceed the yield value of the ducting since this may cause permanent deformation to the duct as well as loss to the integrity of the polyethylene.

These duct pullers are installed quickly and easily and require no special tooling. A new tooth profile makes removal much easier than the earlier models.

Duct wall thickness is normally designated by an SDR value. The lower the SDR value, the heavier the wall thickness. These products can be used on SDR 9 through SDR 17 ducting and Schedule 40 pipe.

Part No.	Nominal Duct Size	3:1 Safe Working Load	Rear Eye Capacity (3:1 SWL)	Minimum Inside Duct Diameter	Maximum Inside Duct Diameter	Maximum Outside Duct Diameter	Weight
00650-100	1"	3,100 lb	1,000 lb	1.000" / 25.4 mm	1.250" / 31.8 mm	1.350" / 76.2 mm	1.5 lb
00650-125	1-1/4"	3,100 lb	1,000 lb	1.250" / 31.8 mm	1.500" / 38.1 mm	1.656" / 42.1 mm	1.9 lb
00650-150	1-1/2"	3,600 lb	1,000 lb	1.438" / 36.5 mm	1.688" / 42.9 mm	1.906" / 48.4 mm	2.2 lb
00650-200	2"	5,600 lb	1,000 lb	1.813" / 42.9 mm	2.188" / 55.6 mm	2.375" / 60.3 mm	3.9 lb
00650-250	2-1/2"	8,200 lb	1,000 lb	2.188" / 55.6 mm	2.563" / 77.8 mm	2.875" / 73.0 mm	5.6 lb
00650-300	3"	12,200 lb	1,000 lb	2.688" / 68.3 mm	3.063" / 77.8 mm	3.500" / 88.9 mm	7.33 lb
00650-400	4"	20,100 lb	1,500 lb	3.438" / 87.3 mm	4.250" / 108.0 mm	4.500" / 114.3 mm	17.3 lb
00650-500	5"	30,700 lb	1,500 lb	4.313" / 109.5 mm	5.125" / 130.2 mm	5.563" / 141.3 mm	26.5 lb
00650-600	6"	43,600 lb	2,500 lb	5.063" / 128.6 mm	6.063" / 154.0 mm	6.625" / 168.3 mm	48.0 lb

Note: Safe Working Load is based on the duct yield strength to protect from creep failure.

## Metric Version

These Duct Pullers are the same as the 00650 series, but are designed with jaws that allow sizing to metric duct sizes.

Part No.	Nominal Duct Size	3:1 Safe Working Load	Rear Eye Capacity (3:1 SWL)	Minimum Inside Duct Diameter	Maximum Inside Duct Diameter	Maximum Outside Duct Diameter	Weight
00651-040	40 mm	13.8 kN	4.8 kN	1.280" / 32.5 mm	1.500" / 38.1 mm	1.575" / 40.0 mm	0.95 kg
00651-050	50 mm	16.0 kN	4.8 kN	1.437" / 36.5 mm	1.736" / 44.1 mm	1.969" / 50.0 mm	1.0 kg
00651-063	63 mm	24.9 kN	4.8 kN	2.000" / 50.8 mm	2.248" / 57.1 mm	2.480" / 63.0 mm	1.8 kg
00651-075	75 mm	36.5 kN	4.8 kN	2.374" / 60.3 mm	2.626" / 66.7 mm	2.953" / 75.0 mm	2.7 kg
00651-090	90 mm	54.3 kN	4.8 kN	2.874" / 73.0 mm	3.189" / 81.0 mm	3.543" / 90.0 mm	3.9 kg
00651-110	110 mm	89.4 kN	6.6 kN	3.374" / 85.7 mm	3.937" / 100.0 mm	4.331" / 110.0 mm	7.8 kg
00651-125	125 mm	110.0 kN	6.6 kN	3.890" / 98.8 mm	4.390" / 111.5 mm	4.921" / 125.0 mm	9.6 kg
00651-140	140 mm	136.6 kN	6.6 kN	4.488" / 114.0 mm	5.000" / 127.0 mm	5.512" / 140.0 mm	12.0 kg
00651-160	160 mm	193.9 kN	11.4 kN	4.937" / 125.4 mm	5.626" / 142.9 mm	6.299" / 160.0 mm	26.0 kg

Note: Safe Working Load is based on the duct yield strength to protect from creep failure.



## Duct Puller Replacement O-Rings

Replacement O-Rings are available for the 00616, 00617, 00620, 00621, 00650, and 00651 Duct Pullers.

Duct Puller	O-Ring	Quantity	Position
00616-125	90027-087U	2	Jaw
00616-150	90027-118U	2	Jaw
00616-200	90027-138U	2	Jaw
00616-250	90027-175U	3	Jaw
00616-300	90027-213U	3	Jaw
00616-400	90027-287U	3	Jaw
00616-500	90027-3751U	3	Jaw
00616-600	90027-425U	3	Jaw
00620-125	90027-100	2	Jaw
00620-150	90027-100	2	Jaw
00620-200	90027-175U	2	Jaw
00620-250	90027-213U	3	Jaw
00620-300	90027-250U	3	Jaw
00620-400	90027-250U	3	Jaw
00620-500	90027-400	4	Jaw
00620-600	90027-475	4	Jaw
00620-800	90027-5001	2	Jaw
	90027-5871V	1	Jaw
00620-1009	90027-6001	3	Jaw
00620-1011	90027-6001	3	Jaw
00620-1017	90027-6001	3	Jaw
00620-1209	90027-7381	5	Jaw
00620-1211	90027-7381	5	Jaw
00620-1217	90027-7381	5	Jaw
00650-100	90027-087U	2	Jaw
	90027-187	1	Body
	90027-137	2	Shaft
00650-125	90027-087U	2	Jaw
	90027-187	1	Body
	90027-137	2	Shaft
00650-150	90027-118U	2	Jaw
	90027-206	1	Body
	90027-118U	2	Shaft
00650-200	90027-138U	2	Jaw
	90027-262	1	Body
	90027-156	2	Shaft
00650-250	90027-175U	3	Jaw
	90027-312	1	Body
	90027-156	2	Shaft
00650-300	90027-213U	3	Jaw
	90027-375	1	Body
	90027-156	2	Shaft
00650-400	90027-287U	3	Jaw
	90027-475	1	Body
	90027-218	2	Shaft
00650-500	90027-3751U	3	Jaw
	90027-587	1	Body
	90027-218	2	Shaft
00650-600	90027-425U	3	Jaw
	90027-700	1	Body
	90027-268	2	Shaft

Duct Puller	O-Ring	Quantity	Position
00617-040	90027-087U	2	Jaw
00617-050	90027-118U	2	Jaw
00617-063	90027-138U	2	Jaw
00617-075	90027-175U	3	Jaw
00617-090	90027-213U	3	Jaw
00617-110	90027-287U	3	Jaw
00617-125	90027-3751U	3	Jaw
00617-140	90027-425U	3	Jaw
00617-160	90027-450U	3	Jaw
00621-040	90027-100	2	Jaw
00621-063	90027-175U	2	Jaw
00621-075	90027-213U	3	Jaw
00621-090	90027-250U	3	Jaw
00621-110	90027-250U	3	Jaw
00621-125	90027-300	4	Jaw
00621-140	90027-400	4	Jaw
00621-160	90027-413	4	Jaw
00621-180	90027-475	4	Jaw
00621-200	90027-5001	2	Jaw
	90027-5871V	1	Jaw
00651-040	90027-087U	2	Jaw
	90027-1751	1	Body
	90027-137	2	Shaft
00651-050	90027-118U	2	Jaw
	90027-2131	1	Body
	90027-137	2	Shaft
00651-063	90027-138U	2	Jaw
	90027-275U	1	Body
	90027-156	2	Shaft
00651-075	90027-175U	3	Jaw
	90027-3251	1	Body
	90027-156	2	Shaft
00651-090	90027-213U	3	Jaw
	90027-387	1	Body
	90027-156	2	Shaft
00651-110	90027-287U	3	Jaw
	90027-462	1	Body
	90027-218	2	Shaft
00651-125	90027-325U	3	Jaw
	90027-525	1	Body
	90027-218	2	Shaft
00651-140	90027-3751U	3	Jaw
	90027-575	1	Body
	90027-218	2	Shaft
00651-160	90027-425U	3	Jaw
	90027-675	1	Body
	90027-268	2	Shaft

Note: DCD O-Rings are typically made from Nitrile, but part numbers marked with a "U" at the end are made from Urethane and those with a "V" at the end are made from Viton.

## Spiral Duct Brush

Flat steel bristles spiralled onto heavy duty wire spindle with a pulling eye on one end only. This product will quickly remove grit or light dirt within the duct before installing your cable.



Part No.	Nominal Duct Size	Actual Outside Diameter	Weight
08000-125	1-1/4"	1-1/4"	0.39 lb
08000-150	1-1/2"	1-1/2"	0.41 lb
08000-200	2"	1-7/8"	0.42 lb
08000-250	2-1/2"	2-1/4"	0.67 lb
08000-300	3"	2-3/4"	0.71 lb
08000-350	3-1/2"	3-1/4"	0.75 lb
08000-400	4"	3-5/8"	0.79 lb
08000-500	5"	4-3/8"	0.85 lb
08000-600	6"	5-1/4"	0.92 lb

## Heavy Duty Duct Brush

These heavy duty wire brushes are fitted with a pulling eye on each end so the brush can be pulled back and forth for those extra tough cleaning jobs.



Part No.	Nominal Duct Size	Actual Outside Diameter	Weight
08100-125	1-1/4"	1-1/4"	0.69 lb
08100-150	1-1/2"	1-1/2"	0.74 lb
08100-200	2"	1-7/8"	0.77 lb
08100-250	2-1/2"	2-1/4"	1.21 lb
08100-300	3"	2-3/4"	1.25 lb
08100-350	3-1/2"	3-1/4"	1.39 lb
08100-400	4"	3-5/8"	1.37 lb
08100-500	5"	4-3/8"	1.55 lb
08100-600	6"	5-1/4"	1.82 lb

## Test Slug

These Test Slugs are simple aluminum mandrels designed to be pulled through the duct to test for out of roundness. The slug diameters will fill approximately 70% of Schedule 40 ducting and 80% of Schedule 80 ducting. The ends are rounded for convenient pulling in either direction.



Part No.	Nominal Duct Size	Body Diameter	Body Length	3:1 Safe Working Load	Weight
08450-150	1-1/2"	1.33"	1.68"	2,300 lb	0.4 lb
08450-200	2"	1.73"	2.37"	2,300 lb	0.7 lb
08450-250	2-1/2"	2.06"	2.94"	2,300 lb	1.1 lb
08450-300	3"	2.60"	3.50"	2,300 lb	1.6 lb
08450-350	3-1/2"	2.96"	4.06"	4,800 lb	2.7 lb
08450-400	4"	3.42"	4.81"	4,800 lb	4.1 lb
08450-500	5"	4.30"	5.94"	4,800 lb	7.1 lb
08450-600	6"	5.15"	7.06"	4,800 lb	11.5 lb

## Steel Duct Checker™

The Steel Duct Checker™ is designed to ensure the duct bore is clear before installing the cable or other utility. Following initial installation of the ducting, it is often a requirement that certain sized mandrels be pulled through the ducting to ensure that there has been no collapse or obstruction in the duct.

The steel discs are tumbled to ensure no burrs and spacers ensure easy bending around corners. The wire rope running through the mandrel is high quality galvanized wire.

Check the inside diameter of the ducting before selecting the product from the chart below.



Part No.	Nominal Duct Size	Maximum Disc Diameter	3:1 Safe Working Load	Weight
08400-200	2"	1.69"	4,800 lb	3.53 lb
08400-300	3"	2.65"	4,800 lb	5.56 lb
08400-400	4"	3.57"	4,800 lb	10.2 lb
08400-500	5"	4.56"	4,800 lb	17.2 lb
08400-600	6"	5.51"	4,800 lb	25.9 lb
08400-800	8"	7.26"	4,800 lb	45.5 lb

## Poly Duct Checker™

The Poly Duct Checker™ is designed to ensure the duct bore is clear before installing the cable or other utility. Following initial installation of the ducting, it is often found that debris or partial collapse of the duct will impede installation of the cable.

The discs are manufactured from high density polyurethane giving them the toughness to clear the duct without scraping or scratching the bore walls. The discs are spaced with gaps to allow passage through tight bends. The wire rope running through the mandrel is high quality, galvanized wire.

Check the inside diameter of the ducting before selecting the product from the chart below.



Part No.	Nominal Duct Size	Maximum Disc Diameter	Minimum Bend Radius	Length	3:1 Safe Working Load	Ultimate Load	Weight
08500-125	1-1/4"	1.19"	2"	15"	1,400 lb	4,200 lb	0.42 lb
08500-150	1-1/2"	1.44"	1-5/8"	15"	1,400 lb	4,200 lb	0.50 lb
08500-200	2"	1.88"	2-3/4"	17-7/8"	2,300 lb	6,900 lb	0.90 lb
08500-250	2-1/2"	2.19"	3-5/8"	17-7/8"	2,300 lb	6,900 lb	1.04 lb
08500-300	3"	2.81"	2-3/4"	17-7/8"	2,300 lb	6,900 lb	1.46 lb
08500-350	3-1/2"	3.25"	4-1/4"	20-1/2"	4,800 lb	14,400 lb	2.57 lb
08500-400	4"	3.75"	3"	22"	4,800 lb	14,400 lb	3.45 lb
08500-500	5"	4.69"	3-3/4"	22-1/2"	4,800 lb	14,400 lb	4.71 lb
08500-680	6" Schedule 80	5.50"	5-1/4"	22-1/2"	4,800 lb	14,400 lb	6.24 lb
08500-640	6" Schedule 40	5.81"	5-1/4"	22-1/2"	4,800 lb	14,400 lb	7.16 lb
08500-880	8" Schedule 80	6.86"	5-1/2" est.	22-1/2"	4,800 lb	14,400 lb	9.30 lb
08500-840	8" Schedule 40	7.40"	5-1/2" est.	22-1/2"	4,800 lb	14,400 lb	11.00 lb



## Fiber Optic Sheaves & Quadrants

For pulling fiber optic cable, DCD has a special series of sheaves and quadrants that will allow the maximum possible bend radius for the application. All the sheaves are aluminum while the quadrant side plates are 3/16" steel, giving the best combination of light weight and strength.

The Fiber Optic Quadrant has twelve rollers set on a 26" radius giving the cable a minimum 26-3/4" inside bend radius.

The one piece Fiber Optic Sheave is sized to fit through a 24" manhole and both the sheave and the quadrant can be used in the DCD Manhole Brace (32700 series).

The hanger arms also separate easily to allow insertion of the sheave or quadrant in the middle of the pull.



Fiber Optic Quadrant with Single Hanger	Fiber Optic Quadrant with Double Hanger	Single Hanger Only	Double Hanger Only	Quadrant Only	Sheave Only	Sheave Width	Sheave Diameter
32200-312	32220-312	32830-301	32810-301	32210-312	32900-303	3"	3"

Fiber Optic Sheave with Single Hanger	Fiber Optic Sheave with Double Hanger	Single Hanger Only	Double Hanger Only	Fiber Optic Sheave Only	Sheave Width	Sheave Diameter
32000-324	32100-324	32800-300	32810-300	32900-324	3"	24"

## Sheave Hangers

DCD offers single or double hangers to go with their series of cast aluminum sheaves. The single hangers are provided with a safety hook and the double hangers have one hook and one pin through which a rope may be fed or other items attached.

The sheaves are all cast aluminum with machined faces and bores. They are then fitted with high load iron-bronze flanged bushings.

All parts are designed to take 10,000 lb line load allowing for a 3:1 safety factor.

One feature of the hangers is the ease with which they are assembled to either a sheave or a quadrant. A simple pin with a handle at one end and a locking pin at the other does the job. It should be noted that the handle at one end of the pin may be used to support the hanger in a horizontal position should that be necessary.

The sheaves and hangers may be purchased as assemblies or individually as shown in the table below.



Sheave with Single Hanger	Sheave with Double Hanger	Single Hanger Only	Double Hanger Only	Sheave Only	Sheave Width	Sheave Diameter
32000-420	32100-420	32800-400	32810-400	32900-420	4"	20"
32000-526	32100-526	32800-500	32810-500	32900-526	5"	26"
32000-611	32100-611	32800-600	32810-600	32900-611	6"	11"
32000-620F*	32100-620F	32800-600	32810-600	32900-620F	6"	20"
32000-626	32100-626	32800-601	32810-601	32900-626	6"	26"
32000-811	32100-811	32800-800	32810-800	32900-811	8"	11"
32000-811F*	32100-811F	32800-800	32810-800	32900-811F	8"	11"

\* F designates Flat Bottom Sheave.  
Note: Double Hangers are supplied with one hook.

## Quadrants & Hangers

DCD quadrants are designed to withstand up to 10,000 lb working line load with a 3:1 safety factor. This means they can be used safely at either the entry end of the installation or the exit end. The steel side plates along with the high strength bushings on each roller are all designed with strength, safety and weight in mind.

All quadrants have countersunk screws holding the rollers so there are no protrusions from the side plates and the hangers can travel the full arc of the quadrant.

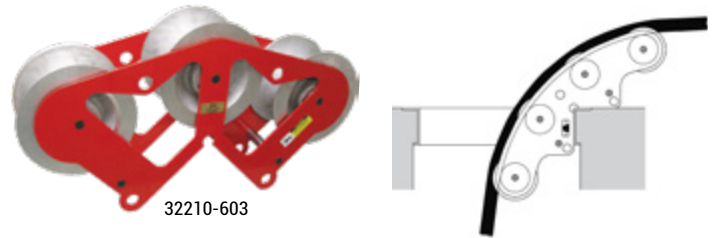

Quadrant with Hanger	Quadrant Only	Hanger Only	Sheave Only	Sheave Width	Sheave Diameter	No. of Sheaves	Minimum Cable Radius
32200-304	32210-304	32830-300	32900-307	3"	7"	4	27-7/8"
32200-404	32210-404	32800-400	32900-407	4"	7"	4	27-7/8"
32200-504	32210-504	32800-500	32900-507	5"	7"	4	27-7/8"
32200-603	32210-603	32800-600	32900-611	6"	11"	3	28-3/4"
32200-803	32210-803	32800-800	32900-811	8"	11"	3	28-3/8"

## Corner Guides

DCD Corner Guides are designed to withstand a 10,000 lb working line load with a 3:1 safety factor. The sheaves run in high strength iron-bronze bushings. The Corner Guides also have a wide base for stability, a deep lip for hooking into the manhole and two locations for hold down bars and lightening holes added everywhere possible.

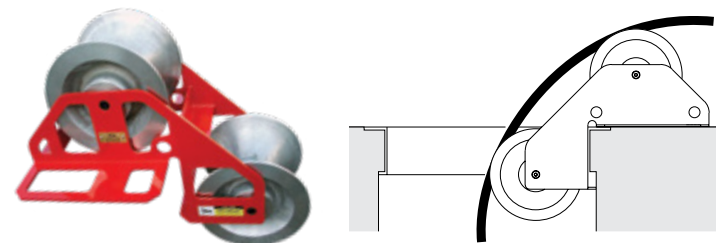

Guide Part No.	Sheave Only	Sheave Width	Sheave Diameter	Weight
32300-400	32900-411	4"	11"	58.5 lb
32300-500	32900-511	5"	11"	63.5 lb
32300-600	32900-611	6"	11"	70.5 lb
32300-800	32900-811	8"	11"	88.5 lb

Note: Add 'F' to end of part number for Flat Bottom Sheave.

## Wire Rope Guide

DCD Wire Rope Guides are designed to withstand over 10,000 lb safe working line load. The hardened rollers run on ball bearings at each end for smooth easy rotation and the rollers have a flange at each end to prevent the rope from riding off either side. The product also has an extra deep lip to hook into the manhole.

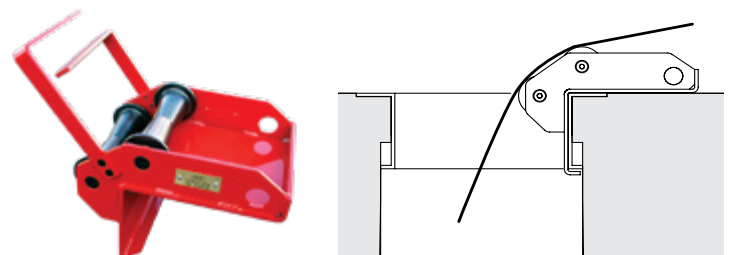

Part No.	Spare Sheave	3:1 Safe Working Load	Sheave Width	Sheave Diameter	Weight
32400-200	32900-702	10,000 lb	7"	2"	28.0 lb

## Safety Lifting Bar

This is simply a plain bar that can be used to prevent products such as the corner guides, quadrants or wire rope guides from falling into the manhole. Each of these products has one or two holes through them, which allows the safety bar to be positioned and tied back if needed. This product can also be used by two people to carry heavier products between them.



Part No.	Length	Diameter	Weight
32950-048	48"	1-1/4"	16.0 lb

## Rim Roller

This product is designed to fit over the rim surrounding many electrical installations. While cable is being installed, this product will allow the cable to run over that rim without tearing or damaging the jacket.

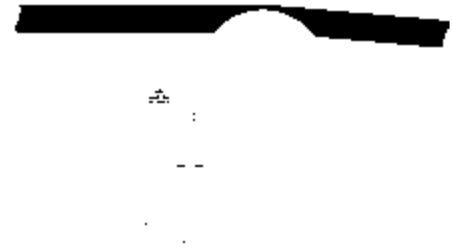

Part No.	Spare Sheave	3:1 Safe Working Load	Sheave Width	Sheave Diameter	Weight
32450-400	32900-407	10,000 lb	4"	7"	14.5 lb

## Duct Entry Guide

The Duct Entry Guide is unique for two reasons. First, it has an extra long tube section that goes inside the duct (see dimension A in the diagram on the right) for greater stability.

Second, because of the built-in spray nozzle for the DCD Tube-Lube® 326 application, there is one half of a quick-disconnect coupling attached to a spray nozzle that will direct the lubricant right onto the cable as it is fed into the ducting. This is a unique feature for a unique lubricant.

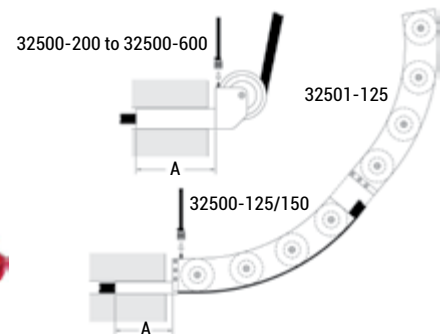

Part No.	Spare Sheave	3:1 Safe Working Load	Duct Diameter	A	Weight
32500-125*	32900-202P**	3,000 lb	1-1/4"	7-1/2"	7.4 lb
32500-150*	32900-202P**	3,000 lb	1-1/2"	7-1/2"	7.5 lb
32501-125*	32900-202P**	3,000 lb	Extension Quadrant	-	5.7 lb
32500-200	32900-303	3,000 lb	2"	7-1/2"	5.3 lb
32500-250	32900-303	3,000 lb	2-1/2"	7-1/2"	5.7 lb
32500-300	32900-307	6,000 lb	3"	9-1/2"	14.1 lb
32500-400	32900-407	6,000 lb	4"	11-1/2"	19.0 lb
32500-480	32900-407	6,000 lb	4" Schedule 80	11-1/2"	17.0 lb
32500-500	32900-507	6,000 lb	5"	13-1/2"	24.0 lb
32500-600	32900-611	6,000 lb	6"	15-1/2"	44.0 lb

\* For use with Fiber Optic Cable only. Extension Quadrant may be used with -125 & -150 only.

\*\* The 'P' style of Sheave is made from industrial grade plastic.

## Sheaves

All DCD sheaves are cast from 356-T6 aluminum. This is a heat treated material giving over 33,000 lb of tensile strength, making it one of the strongest types of aluminum castings available.

Each sheave is fitted with an iron bronze bushing that take either 1-1/4" or 3/4" dia. shafts. All DCD sheave axles are made from high strength chrome plated shafting. With almost twice the load bearing capability of regular bronze bushings, the DCD sheaves are designed to take the full load at either entry or exit points of the pull.

DCD also offers flat bottom sheaves. The purpose of these sheaves is to allow parallel seating of three cables on the sheave – this prevents 'bunching' of the cables which in turn often causes one or more of them to ride up the side of a standard radiused sheave, possibly causing damage to the cable jackets. take the full load at either entry or exit points of the pull.

Note: Sheaves are available in Delrin upon request. Contact Customer Service for more information.

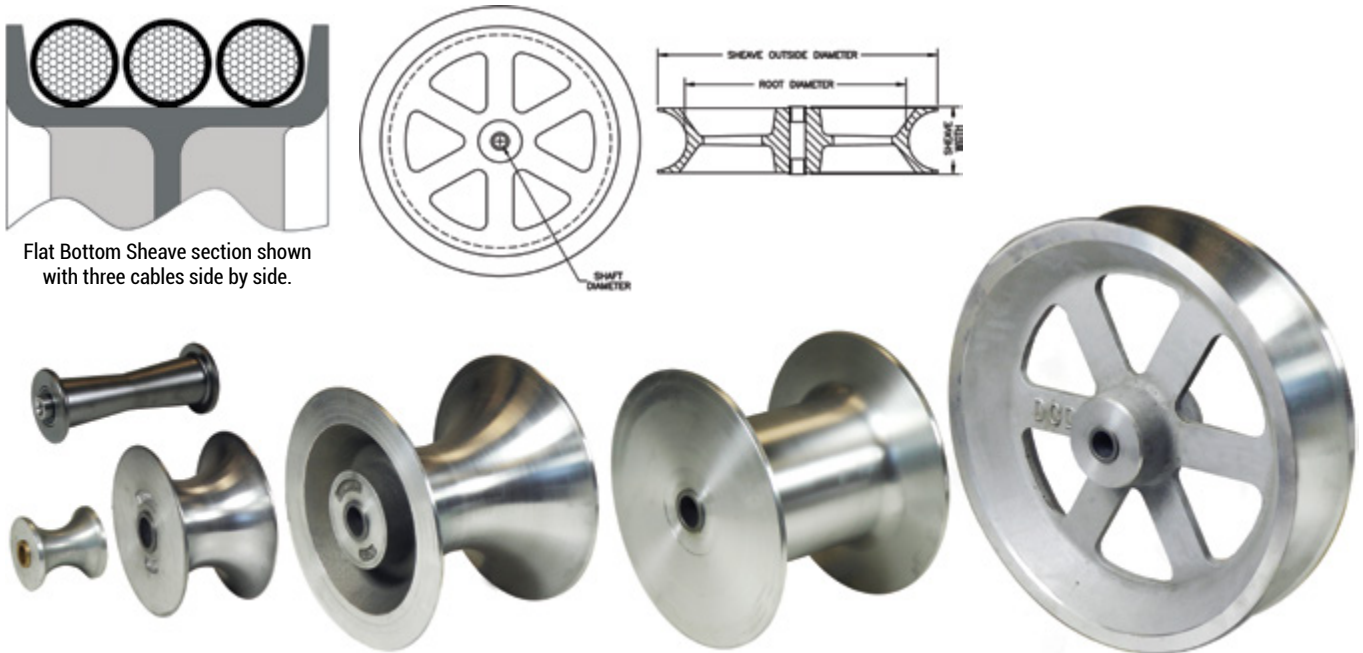

Flat Bottom Sheave section shown with three cables side by side.

Part No.	Sheave Outside Diameter	Sheave Width	Maximum Cable Diameter	Root Diameter	Shaft Diameter	Weight
32900-202P*	2-3/8"	2-1/4"	1-3/16"	1-1/8"	5/8"	0.2 lb
32900-303	3"	3"	2-1/2"	1-1/2"	3/4"	1.1 lb
32900-307	7"	3-3/8"	3"	3-3/4"	1-1/4"	6.0 lb
32900-324	23-3/4"	3	1-3/8"	21-1/4"	1-1/4"	17.0 lb
32900-407	7"	4"	3-3/4"	3-3/4"	1-1/4"	8.0 lb
32900-411	11"	4-3/8"	4"	7-1/2"	1-1/4"	15.0 lb
32900-420	20"	4-3/4"	4"	17"	1-1/4"	31.0 lb
32900-507	7"	4-3/4"	4-5/8"	3-3/4"	1-1/4"	9.0 lb
32900-511	11"	5-3/8"	5"	6-1/2"	1-1/4"	18.0 lb
32900-526	26-5/8"	5-3/8"	4-7/8"	22-1/2"	1-1/4"	49.0 lb
32900-526F**	26-5/8"	5-3/8"	3 x 1-1/2"	23-1/2"	1-1/4"	51.0 lb
32900-611	11"	6-3/8"	5-7/8"	5-1/2"	1-1/4"	21.0 lb
32900-620F**	20-7/8"	6-3/8"	3 x 1-3/4"	17"	1-1/4"	47.0 lb
32900-626	26-5/8"	6-3/8"	5-7/8"	21"	1-1/4"	65.0 lb
32900-702	3"	7"	3/4"	1-1/2"	-	5.0 lb
32900-811	11"	8-3/8"	8"	4-3/4"	1-1/4"	27.0 lb
32900-811F**	11"	8-3/8"	3 x 2-3/8"	6"	1-1/4"	24.0 lb

\* P designates Polyurethane Sheave.

\*\* F designates Flat Bottom Sheave.



## Meter Box Puller

Designed for use by power utilities or contractors who are pulling new residential service lines through conduit. The head of the Meter Box Puller fits snugly in the meter enclosure, while the handle is strapped to the PVC conduit that goes from the ground to the meter box.

During the pull, the sheaves in the head make the pull easier, while the handle presses against the PVC conduit helping to keep the conduit and the meter box from pulling out from the wall.



Part No.	3:1 Safe Working Load	Nominal PVC Conduit Diameter	Weight
32460-000	1,250 lb	3" to 4"	8.1 lb
32460-300	1,250 lb	3"	7.8 lb

## Flexible Cable Guides

The DCD Flexible Cable Guide comes in 5' or 10' lengths. Custom lengths are also available. At each end there is a polyurethane coupling that can be used for attaching two lengths together and for attaching the duct adapter and the cable entry cone.

There are three different diameters or sizes of flexible guides. The 4" size has adapters suitable for 2", 3" and 4" duct sizes, the 5" size only fits 5" duct, and the larger 6" unit has adapters suitable for 4", 5", and 6" ducting.

Each duct adapter is fitted with a spray nozzle suitable for the DCD Tube-Lube® 326. There is one half of a quick-disconnect coupling attached to the nozzle that will direct the lubricant onto the cable as it is fed into the ducting.

Like the end fittings, the duct adapters are made from polyurethane and are also sold separately.

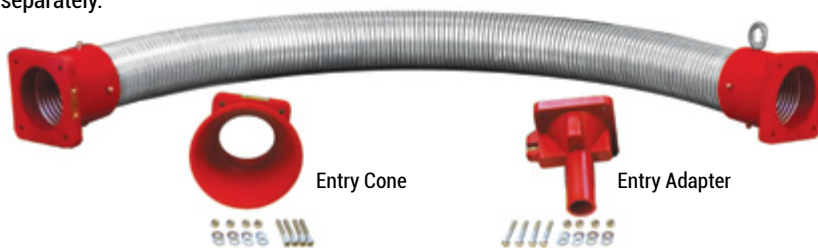
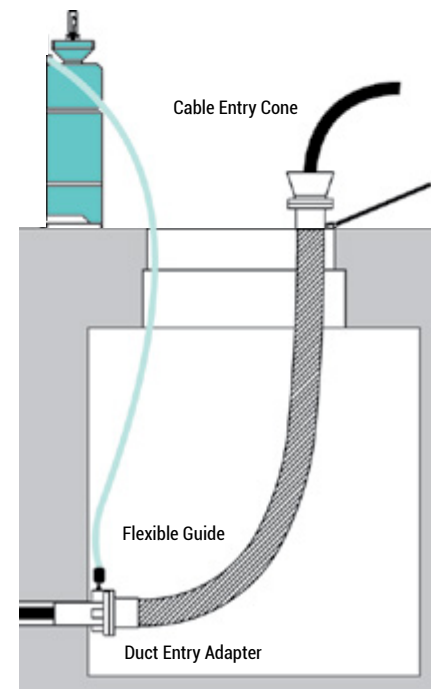

Flexible Guide Part No.	Diameter	Length	Cable Entry Cone Part No.
32600-405	4"	5'	32610-300
32600-410	4"	10'	32610-400
32600-505	5"	5'	32610-500
32600-510	5"	10'	32610-500
32600-605	6"	5'	32610-600
32600-610	6"	10'	32610-600

Duct Entry Adapter Part No.	Use with Flexible Guide Diameter	Nominal Duct Size
32620-420	4"	2"
32620-425	4"	2-1/2"
32620-430	4"	3"
32620-440	4"	4"
32620-550	5"	5"
32620-640	6"	4"
32620-650	6"	5"
32620-660	6"	6"

Note: Contact Customer Service regarding custom lengths.

## Poly Entry Bell

This product is used for guiding the cable into the ducting. The polyurethane material is self lubricating which helps to smooth the passage of cable into the duct.



Part No.	Nominal Duct Diameter	Weight
32510-300	3"	0.9 lb
32510-400	4"	1.4 lb
32510-500	5"	1.7 lb

## Nylon Cable Protector

These products are common to the industry and serve to protect the cable while being fed into the duct. They may be left in place if there is concern about wear between the duct edge and the cable.



Part No	Description	Weight
32560-200	For 2" to 3" duct (package of 10 pieces)	0.7 lb
32560-300	For 3" to 6" duct (package of 10 pieces)	1.4 lb

Note: Sold in boxes of 10. Not sold individually.

## Split Entry Bells

The DCD Split Entry Bell is designed to allow continuation of a single cable pull through a manhole – out one side and into another side. The split feature allows removal of the guide after installation. Split Bells are available in long wearing bronze or lower cost aluminum. Bronze bell halves are held together with wing nuts and bolts while the aluminum bells use dowel pins and one lug has a 3/4" dia. lifting hole.

Add an L to the end of the part number to order the Entry Bell complete with a Lube Fitting for the DCD Tube-Lube® 326 applicator systems.

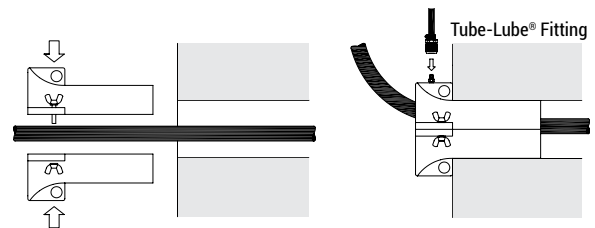

Aluminum Bell Part No.	Bronze Bell Part No.	Nominal Duct Diameter	Aluminum Weight	Bronze Weight
32550-200A	32550-200B	2"	2.0 lb	5.7 lb
32550-300A	32550-300B	3"	2.6 lb	7.2 lb
32550-400A	32550-400B	4"	3.3 lb	9.4 lb
32550-450A	32550-450B	4-1/2"	3.5 lb	9.4 lb
32550-500A	32550-500B	5"	4.1 lb	11.5 lb
32550-600A	32550-600B	6"	4.8 lb	13.1 lb

## Cable Separators

Polyurethane Cable Separators are available in 3-way or 4-way units to suit 2", 4", 5" or 6" ducting. They are designed to fit in the feed-in end of the duct and to align multiplex cable for smoother entry into the duct.



Part No.	Nominal Duct Size	Minimum Duct Diameter	Maximum Cable Diameter	Style	Color Code	Weight
32650-200	2"	1-15/16"	3/4"	3-way	Black	0.3 lb
32650-400	4"	3-13/16"	1-9/16"	3-way	Red	1.0 lb
32650-500	5"	5-1/32"	2-1/8"	3-way	Red	1.4 lb
32650-600	6"	5-3/4"	2-7/16"	3-way	Red	1.5 lb
32655-400	4"	3-13/16"	1-5/16"	4-way	Black	1.5 lb
32655-500	5"	5-1/32"	1-13/16"	4-way	Black	2.0 lb
32655-600	6"	5-3/4"	2-1/8"	4-way	Black	2.2 lb

## Manhole Brace

The DCD Manhole Brace may look like other products on the market, but look again. There are several features that make it stand out from other similar products:

- Pivoting Head** - In many applications the top of the brace cannot jam against a round manhole, instead it may be jammed against a square cutout in the roof of the manhole vault. The DCD Manhole Brace has a pivotable upper head which allows the brace and sheave to be accurately aligned with the duct bank without the need for temporary shoring/bracing.
- Custom Extruded Channels** - The aluminum channels have been custom extruded to an engineered design. Their shape provides the maximum strength-to-weight ratio while also providing a smooth sliding action. The channels have approximately twice the strength as the standard aluminum channels used in similar products, allowing a full 10,000 lb line load to be applied at either entry or exit end of the pull. This load allows in excess of a 2:1 safety factor.
- Fixed Angle** - The brace operates at a fixed angle of 10 degrees. There is an acme screwjack assembly to adjust the height of the brace. This same screw can be used to relieve the pressure on the brace when it is being removed.
- Lifting Bar** - The lifting bar provided allows the user to easily raise the upper extension into its correct position. This bar can be swung out of the way and stored when not in use.
- Locking Pins** - The brace uses separate locking pins for each set of channels. Using two locking pins ensures that they do not interfere with the desired placement of the sheave or quadrant.
- Fixed Width** - This fixed width brace is designed to accept quadrants or sheaves up to 8" wide. Since correct alignment to the duct entrance is now possible with the rotating head, even use of only a 4" wide sheave is no problem inside the 8" available width. The sheave will simply float between the side rails, always picking up the most favorable alignment.
- Construction** - Although the side channels are extruded aluminum, the upper and lower assemblies are made out of steel. While increasing the overall weight by a few pounds, the added strength of steel is necessary in order to match the strength of the extruded side channels. The end result is a brace that can operate equally at either end of the pull and one that will match the safe working loads of all other DCD manhole products at 10,000 lb. The base section is used in all assemblies and comes complete with two locking pins and one sheave pin. The short, medium or long extension should be ordered to suit the height range requirement.



Sheave sold separately.

Locking pins and sheave pins come with securing pins that may be ordered separately.

Note: Replacing any parts with components other than those supplied by DCD will void the warranty and may cause serious damage to persons or equipment.

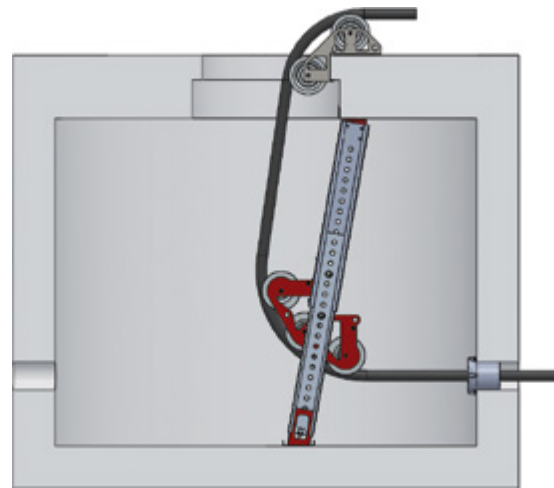
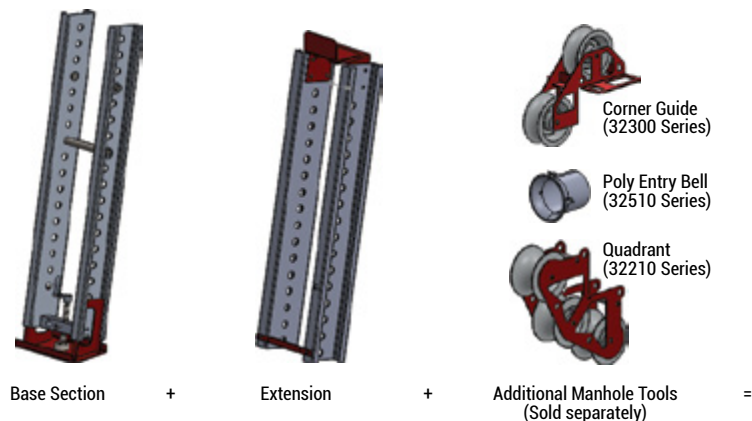

Full Assembly

Part No.	Description	Options	Height Range	Weight
32700-000	Base Section	Mandatory	-	64.5 lb
32700-010	Short Extension	Add-on	5' to 8'	54.5 lb
32700-020	Medium Extension	Add-on	7' to 10'	72.5 lb
32700-030	Long Extension	Add-on	9' to 12'	89.0 lb
32700-035	Extra Long Extension	Add-on	12' to 15'	105.0 lb
32700-040	Locking Pin Kit (1-1/4" long)	Spare	-	1.0 lb
32700-050	Sheave Pin Kit (11" long)	Spare	-	4.0 lb

Note: Base Section and one of the Extensions are both required to make this product work.

## Tube-Lube® 326

The benefits of DCD's premier cable lubricant include:

- Excellent lubrication and reduction of friction. Field tests show pulling loads can be reduced by over 50%, which is on par with the other leading brands.
- Proven to reduce the coefficient of friction – tests on PVC duct with polyethylene jacketed cable show this to be 0.13.
- Lower friction means longer cable pulls and lower viscosity means less drag on the jacket.
- Clean and easy to use – spray what you need where it's needed for less waste.
- Lubricant will flow around the cable when sprayed on, simply leaving a thin coating of lubricant all around the cable jacket, eliminating dry spots on the cable and further reducing friction. This also reduces usage by up to 50%.
- Can be used equally well for heavy power cable or CATV cable.
- Suitable for cable blowing. In Europe, it is recommended by Lancier, one of the original developers of cable blowing machines and equipment.
- Can be used with several different applicator systems now offered by DCD (see following page).
- Good for winter or summer temperatures (-4°F to 149°F / -20°C to 65°C).
- Minimal evaporation – active ingredients do not dry out after application so cable removal years later is easy. Unfinished applications can easily be started up again the next day.
- Contains no Volatile Organic Compounds and no silicone oils, yet is compatible with silicone.
- Safe, non-toxic, biodegradable, and non-flammable.
- Successfully tested to IEEE standards for determining compatibility of pulling lubricants, including Low-Smoke Zero-Halogen jacket and Semi-Conductive materials.
- Successfully tested to ASTM standards for environmental stress cracking of cable jackets, also including Low-Smoke Zero-Halogen jacket.
- Price is competitive on a gallon-to-gallon basis alone, so when you figure in the much lower usage, there are excellent savings to be gained.
- Has a shelf life of approximately 2 years, but that can be extended even further with proper care.



## Tube-Lube® Packaging

Tube-Lube® 326 is available in several different sizes and containers:

- 1 quart spray bottle for smaller premise type applications, sold only as a 12 pack.
- 4 pack of 1 gallon jugs (available in pallets of 44 packs) for larger users who prefer the 1 gallon jugs.
- Stackable 5 gallon container (available in pallets of 36 containers) for larger users who prefer the 5 gallon containers.
- In large 265 gallon totes, for the very large user who prefers to put the tote on the dock and let the crews fill up as needed. These totes have a spout and shut off valve located at the bottom of the tote and are returnable and can be re-filled, therefore saving even more costs.

Note: Discounts available on pallet quantities for the 1 gallon jugs and 5 gallon containers.



Part No.	Description	Weight
35000-002	1 Quart Spray Bottle - 12 pack	27 lb
35000-410	1 Gallon Jug - 4 pack	36 lb
35000-050	5 Gallon Container	38 lb
35000-265	265 Gallon Tote (comes with spout and shut-off)	2,500 lb



# Cable Pulling Lubricants

## Tube-Lube® Applicators

The liquid consistency of Tube-Lube® 326 (SG = 1.04) minimizes viscous friction, which allows for easy application through the use of a spray applicator. DCD offers two different spray applicators:

### Manual Applicator Kit

A manually pressurized spray tank with a pressure gauge allows the user to monitor the amount of lube being sprayed onto the cable via the included hand-held wand, or any of DCD's products fitted with a quick connect spray nozzle. Different pressures allow different volumes. A manual shut-off valve leads to a quick disconnect coupling.

A 20' long clear hose is included with the applicator with quick disconnect couplings at each end. This allows the applicator and operator to remain outside the manhole, while the connection to the duct is up to 20' away.



### Power-Spray™ Applicator Kit

This unit holds a little over four gallons and can be carried on the operator's back. A 4-speed pump controls the volume of lube applied. The pump is operated by a re-chargeable battery with about eight hours usage time. The unit comes complete with re-charger and a spare battery. The outlet hose also leads to a quick disconnect coupling.

A 20' long clear hose is included with the applicator with quick disconnect couplings at each end. This allows the applicator and operator to remain outside the manhole, while the connection to the duct is up to 20' away. Semi-clear tank allows visibility of the lube level.



Part No.	Kit Type	Kit Contents	Weight
35100-003	Manual Applicator Kit	Comes with applicator and 20' hose assembly	20.0 lb
35100-002	Power-Spray™ Applicator Kit	Comes with applicator, 20' hose assembly, battery and charger	16.4 lb

## Applicator Kit Replacement Parts & Add-ons

Part No.	Description	Weight
35100-043	Spray Wand Replacement (for Manual Applicator)	0.5 lb
35100-040	20' Hose Assembly (can be used with either sprayer)	1.57 lb
35100-050	Battery Pack for Power-Spray™ Applicator	6.14 lb
35100-051	Battery Wall Charger for Power-Spray™ Applicator	0.30 lb
35100-042	Spray Wand Replacement (comes with 6' hose)	1.0 lb
35100-052	Spray Wand Replacement (for Power-Spray™ Applicator)	0.5 lb

In both above Applicators, the exit hose disconnect coupling and 20' long hose can attach to any of several other DCD products, such as:



**Duct Entry Guide (32500 series):** This product fits right into the duct opening and has a roller that the cable must pass over. The unit is fitted with a spray nozzle that when hooked up, places the lubricant right onto the cable as it passes under the nozzle.



**Flexible Guides (32600 series):** This product attaches to duct entry adaptors and these parts also have a spray nozzle to apply the lubricant right onto the cable as it enters the duct.



**Split Entry Bells (32550 series):** This cable entry guide, available in aluminum and bronze, can be removed easily after installation. Also available with a spray nozzle for direct application of the lube right onto the cable.



**Manual Spray Wand (35100-043):** This wand included with both types of applicator kits so that the hose may be connected to the spray wand and then applied onto the cable drum itself or any other point in the cable travel before entering the duct.

## Tube-Lube® 346

This product is a gel consistency lubricant that is designed for heavy duty application, such as laying large-section power cables inside plastic or concrete ducts. It is also useful in situations that require very little spillage or mess such as indoor applications.

Available only in 5 gallon pails, Tube-Lube® 346 is compatible with all cable jackets and all types of ducting. The product is a heavy duty gel that should be applied to the cable as it enters the ducting and will stay on the cable throughout the pull. This product can be used in temperatures between 14°F and 120°F / -10°C and 48°C.



Part No.	Description	Dimensions	Weight
35300-050	5 Gallon Container of Tube-Lube 346	21-7/8" L x 14-3/8" W x 14-3/8" H	43.5 lb

## Tube-Lube® Summary

Although the importance of proper lubrication is known, sometimes it is difficult to figure out which lubricant would best suit the application at hand. DCD's two lubricant varieties are each best suited to a particular style of usage. The chart below will give you some guidance with choosing the right lubricant for your application. If you have any questions or concerns, please contact Customer Service.



MSDS sheets can be found on our website

Tube-Lube® Type & Series No.	Installing Cables by Pulling	Installing Cables by Blowing	Installing Large Section Power Cables
Tube-Lube® 326 (35000)	Excellent	Good	Good
Tube-Lube® 346 (35300)	Good	Not Suitable	Excellent

## Lube Spreader

This two-part product is designed to spread DCD Tube-Lube® 346 (or similar) around the walls and along the length of the duct, while also acting as a connector. The body is constructed out of stainless steel and the polyurethane disc has angular grooves which allow better distribution of lubricant.

### How to Order

1. Select disc from Table A to fit the internal diameter of conduit to be lubricated.
2. Select connector body from Table B to match selected disc from Table A.

**Table A: Spreader Disc**

Part No.	Disc Diameter	Weight	Connector Body
00515-100	1-1/16"	0.011 lb	00510-010
00515-125	1-3/16"	0.014 lb	00510-010
00515-150	1-5/16"	0.018 lb	00510-010
00515-175	1-7/16"	0.023 lb	00510-010
00515-200	1-7/8"	0.045 lb	00510-025
00515-250	2-3/16"	0.063 lb	00510-025
00515-300	2-13/16"	0.118 lb	00510-025
00515-350	3-1/4"	0.165 lb	00510-035
00515-400	3-3/4"	0.257 lb	00510-035
00515-500	4-11/16"	0.433 lb	00510-035
00515-680	5-1/2"	0.624 lb	00510-035
00515-640	5-13/16"	0.719 lb	00510-035



**Table B: Connector Body**

Part No.	3:1 Safe Working Load	Body Diameter	Overall Length	Weight	Clevis Pin
00510-010	1,500 lb	7/8"	3-3/16"	0.24 lb	00010-SLT
00510-025	4,000 lb	1-3/8"	9-3/16"	0.99 lb	00025-HEX
00510-035	7,200 lb	2"	6-1/2"	2.73 lb	00035-HEX



## Portable Cable Pullers

These lightweight cable pullers are used when you have a job that requires pulling or lifting. DCD pullers are versatile enough that they can be used for smaller cable pulling jobs and lifting transformers. Our pullers have a variety of anchor options, including attaching to a tree, pole, Category III hitch receiver, 2" ball hook, concrete floor, or pylon (transmission tower). Included with each unit is a 6' Polyester Sling (42300-206). Their interchangeable capstan drums mean you can modify the speed and pulling power to suit your needs, and you can use any length of rope you choose. With anti-reversing roller clutch bearings standard on every puller, and an operating position away from the line of pull these pullers are powerful, portable and safe to use for personal or commercial application.

## Pulling-Only Models

These two TUF-Lugger™ Lite models (41000-200, 41000-300) are portable lightweight cable pullers designed for a pulling application. Cable pulling and moving equipment are the primary applications. The capacities identified in the charts below are considered 'single line' capacities. With the correct block and tackle rigging, that capacity could be multiplied. However, the corresponding speed would be effected.

### TUF-Lugger™ Lite

With a powerful gas powered engine this puller comes out of the box ready for pulling jobs up to 2,200 lb. Adding snatch blocks can multiply your pulling strength (depending on the arrangement). Lightweight at only 35 lb, this puller can be carried in and out of remote locations, and with a continuous work cycle and a maximum pulling speed of up to 60' per minute, it will get the job done quickly and efficiently.



Part No.	Application	Engine	Gearbox (Ratio)	Turns at Idle	Maximum Pulling Force	Standard Capstan Size	Pulling Speed (2-1/4" Drum)	Pulling Speed (3-3/8" Drum)	Rope Size (Pulling)	Dimensions	Work Cycle	Weight
41000-200	Pulling	4-Stroke Honda GXH-50cc	Aluminum Alloy (110:1)	Yes	2,200 lb	2-1/4" Drum	40' per minute Max Force: 1,700 lb	60' per minute Max Force: 1,200 lb	3/8" to 5/8"	14-1/4" L x 14-5/8" W x 14-1/4" H	100% Continuous Work	35 lb

### TUF-Lugger™ Lite (High Speed)

The overall pulling weight that this unit can handle is lower than the regular speed model, but with a larger capstan drum, and a lower gear ratio this unit can pull at speeds of up to 115' per minute. The other features that you'll find on the regular speed model are still standard on this model, including the gas engine, and continuous work cycle.



Part No.	Application	Engine	Gearbox (Ratio)	Turns at Idle	Maximum Pulling Force	Standard Capstan Size	Pulling Speed (2-1/4" Drum)	Pulling Speed (3-3/8" Drum)	Rope Size (Pulling)	Dimensions	Work Cycle	Weight
41000-300	Pulling	4-Stroke Honda GXH-50cc	Aluminum Alloy (53:1)	Yes	1,100 lb	3-3/8" Drum	75' per minute Max Force: 1,100 lb	115' per minute Max Force: 770 lb	3/8" to 5/8"	14-1/4" L x 14-5/8" W x 14-1/4" H	100% Continuous Work	35 lb

## Pulling/Lifting Models

These three TUF-Lugger™ Lite models (41000-400, 41000-500, 41000-600) are designed for both pulling and lifting applications. Cable pulling, lifting transformers (electrical boxes), moving equipment are the primary applications. The differences in capacities from pulling to lifting is due to its observed safety factor. Both units are equipped with a clutch and rope grab mechanism.

### TUF-Lugger™ Lite Lifting - Gas

This gas powered unit is used for jobs which require pulling and lifting. The capstan drum comes standard with a safety lip to prevent the rope from slipping off the drum during lifting jobs, and a rope grabbing system to prevent slack or rope slippage if the rope is released during a lift. This puller also features a clutch system which does not turn when idling.



Part No.	Application	Engine	Turns at Idle	Gearbox (Ratio)	Max Force		Standard Capstan Size	Pulling Speed		Rope Size		Work Cycle	Weight	
					Pulling	Lifting		2-1/4" Drum	3-3/8" Drum	Pulling	Lifting			Dimensions
41000-400	Pulling & Lifting	4-Stroke Honda GXH-50cc	No	Aluminum Alloy (110:1)	1,700 lb	555 lb	2-1/4" Drum	40' per min Max Force: 1,700 lb	60' per min Max Force: 1,200 lb	3/8" to 5/8"	1/2"	19-7/8" L x 14-5/8" W x 14-1/4" H	100% Continuous Work	42 lb

### TUF-Lugger™ Lite Lifting - Electric

This electric model gives you the option of working in areas where gas motors are prohibited, such as indoors. With a higher pull load than its gas powered counterpart this electric puller makes a powerful addition to the team. It comes standard with the same rope grabbing system as our other lifting unit, so you can feel confident that this machine is just as safe and reliable.



Part No.	Application	Engine	Gearbox (Ratio)	Max Force		Standard Capstan Size	Pulling Speed		Rope Size		Work Cycle	Weight	
				Pulling	Lifting		2-1/4" Drum	3-3/8" Drum	Pulling	Lifting			Dimensions
41000-500	Pulling & Lifting	AC Electric Baldor TEFC 115/230 vac - 1 ph - 3/4 HP - 60 Hz	Aluminum Alloy (110:1)	1,800 lb	555 lb	2-1/4" Drum	22' per min	35' per min	3/8" to 5/8"	1/2"	21-7/8" L x 14-3/8" W x 14-3/8" H	15 min/hr (to avoid overheating)	53 lb

### TUF-Lugger™ Lite Lifting - Heavy Duty

This gas powered unit is equipped with a Honda GX-160 cc engine, which offers superior performance in a wide variety of tasks, such as erecting towers, lifting antennas, replacing insulators, cable pulling and other arduous tasks.

The integrated rope grabbing system allows the operator to work safely and the start/stop mechanism means he can focus on the task required. This system can be used to lift or lower a load. A wide range of accessories are available to simplify the installation process and anchor this model at various anchoring points such as a vehicle, a post, a pylon and more.



Part No.	Application	Engine	Turns at Idle	Gearbox (Ratio)	Max Force		Standard Capstan Size	Pulling Speed	Rope Size	Dimensions	Work Cycle	Weight
					Pulling	Lifting						
41000-600	Industrial Pulling & Lifting	Honda GX-160cc	No	Aluminum Alloy (53:1)	2,200 lb	990 lb	4-1/4" Drum	72' per min Max Force: 2,000 lb	1/2"	18" L x 14-5/8" W x 14-1/4" H	100% Continuous Work	76 lb



## Capstan Drums with Rope Guide

The option to change your capstan drum means that the unit's speed and pulling capacity are customizable. See specific speeds and capacities in each TUF-Lugger™ Lite spec chart.



Part No.	Size	Weight
42100-225	2-1/4"	1.5 lb
42100-337	3-3/8"	2.0 lb
42100-425*	4-1/4"	2.5 lb

\* Only compatible with 41000-600.

## Capstan Drum Safety Lips

These Safety Lips are easily installed on the outside of the capstan drum to prevent the rope from slipping off the drum during lifting jobs. These are designed for use only with lifting units.



Part No.	Fits Drum Size	Weight
42110-225	2-1/4"	0.36 lb
42110-337	3-3/8"	0.33 lb

## Spark Arrester

This Spark Arrester prevents the engine from ejecting anything flammable and is mandatory in some areas. It is installed quickly and easily with a #2 Phillips screwdriver.



Part No.	Material	Diameter	Weight
42120-000	Aluminum	13/16"	0.75 lb

## Carrying Cases

These cases are designed to protect your unit during transport. The 42130-010 waterproof, airtight case comes with removeable casters, a folding handle, and room for the unit, rope, and many accessories. The 42130-020 is also waterproof & airtight and comes with a folding handle and room for the unit and accessories. The 42130-030 has molded spaces for the unit and accessories; this is our lightest weight option. Finally, the 42130-040 is shock-proof and waterproof with room for the unit and accessories. These cases will protect your investment under extreme conditions.



Part No.	Description	Model No.	Outside Dimensions	Inside Dimensions	Weight
42130-010	Padded Waterproof Case (with casters and handle)	41000-200 41000-300	20" L x 20" W x 19" H	18" L x 18" W x 17" H	27 lb
42130-020	Padded Waterproof Case (with handle)	41000-400 41000-500	23" L x 23" W x 21" H	20" L x 20" W x 20" H	27 lb
42130-030	Transport Case (with molded shapes for accessories)	41000-200 41000-300	25" L x 22" W x 16" H	19" L x 19" W x 15" H	15 lb
42130-040	Padded Waterproof and Airtight Case (with casters)	41000-500 41000-600	25" L x 32" W x 18" H	21" L x 28" W x 16" H	33 lb

## Polyester Sling

Polyester Slings are used to attach the unit or a pulley to an anchor. They are non-stretch.



Part No.	Length	Width	Weight	Breaking Point (Style of Anchor)		
				Vertical	Choker	Basket
42300-206	6'	2"	1.5 lb	3,200 lb	2,500 lb	6,400 lb
42300-208	8'	2"	2.0 lb	3,200 lb	2,500 lb	6,400 lb
42300-210	10'	2"	2.0 lb	3,200 lb	2,500 lb	6,400 lb

## Double Braided Polyester Ropes

Double Braided Polyester Ropes are perfect for use with the TUF-Lugger™ Lite. Their maximum stretch is 12% when at breaking point.



### Unspliced Rope Ends

Part No.	Length	Width	Weight	Breaking Strength
42310-164	164'	1/2"	13 lb	7,275 lb
42310-328	328'	1/2"	26 lb	7,275 lb
42310-656	656'	1/2"	51 lb	7,275 lb
42310-984	984'	1/2"	77 lb	7,275 lb
42315-164	164'	3/8"	8 lb	4,850 lb
42315-328	328'	3/8"	15 lb	4,850 lb
42315-656	656'	3/8"	30 lb	4,850 lb

### Spliced Rope Ends

Part No.	Length	Width	Weight	Breaking Strength
42310-328S	328'	1/2"	27 lb	7,275 lb
42310-656S	656'	1/2"	52 lb	7,275 lb
42310-984S	984'	1/2"	78 lb	7,275 lb

## Rope Bags

Rope Bags come in various sizes and are made out of durable nylon fabric.



Part No.	Size	1/2" Rope Capacity	Weight
42320-020	Small	164'	1.0 lb
42320-030	Medium (Shoulder Straps)	328'	1.7 lb
42320-050	Extra Large	656'	3.1 lb

## Chokers

Chokers are used to grip a log or group of logs that are to be pulled. The steel rod is designed to easily slide underneath logs, and can be used with the Skidding Cone (page 65) to make moving large logs quick and easy.



42330-010



42330-020

Part No.	Description	Dimensions	Maximum Load	Weight
42330-010	HPPE Rope Choker with Steel Pin	7' L x 3/8" W	15,500 lb	1 lb
42330-020	Choker Chain with C-Hook & Steel Pin	7' L x 1/4" W	12,600 lb	6 lb

## Anchor Options

DCD TUF-Lugger™ Lite (41000 series) requires a solid anchor point. These receivers and anchors provide a variety of easy-to-use options for anchoring your unit and ensuring a safe pull or lift.

### Support Plate

This Support Plate is used to attach the puller to a vehicle using 2" Square Tubing (42200 series) or to a pole or tree using the Pole Mount (42200-040). It pivots up to 45 degrees to either side, thus allowing the TUF-Lugger™ Lite to self align with the load during a pull.



Part No.	Material	Dimensions	Weight
42200-010	Zinc plated steel	18" L x 12" W	10 lb

### 2" Square Tubing

This Square Tubing fits into a Category III hitch receiver on a vehicle and creates an anchor point for the Support Plate (42200-010) or Vertical Pull Support (42200-050) using the bent pin style attachment. The new 18" version (42200-021) gives additional working room for a vehicle with a hidden hitch.



Part No.	Material	Dimensions	Weight
42200-020	Zinc plated steel	13" L x 2" W	5 lb
42200-021	Zinc plated steel	18" L x 2" W	7 lb

### Towing Ball Adapter

This easily transportable adapter turns your vehicle into an anchor point for your puller. It fits ball hitches up to 2" in diameter.



Part No.	Material	Dimensions	Weight
42200-030	Zinc plated steel	11" L x 6" W	2 lb

### Pole Mount

This system allows the unit to be securely mounted onto a pole or tree. An adapter then provides support for the puller. This anchor is compatible with the Support Plate (42200-010) and the Vertical Pull Support (42200-050) and requires one of them to be installed before it can be used as an anchor point.



Part No.	Material	Dimensions	Weight
42200-040	Powder coated steel	13" L x 11" W	18 lb

### Vertical Pull Support

The Vertical Pull Support is primarily designed to be used in tandem with the lifting TUF-Lugger™ Lite models. It can be anchored with the Pole Mount (42200-040) or a Category III hitch receiver by using the 2" Square Tubing (42200 series). The pulley provides redirection for the rope so that the main pulling force is in a downward direction.

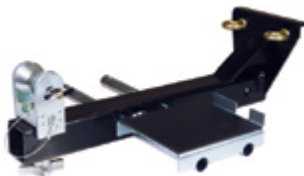

Part No.	Material	Dimensions	Weight
42200-050	Powder coated steel	24" L x 11" W	21 lb

### Pivoting Anchor for Vertical Pull Support

In certain situations, the Vertical Pull Support (42200-050) can be used for pulling instead of lifting. This Pivoting Anchor connects to the support and pivots up to 45 degrees to either side, thus allowing the TUF-Lugger™ Lite to self align with the load during a pull.



Part No.	Material	Dimensions	Weight
42200-051	Zinc plated steel	9" L x 6-1/2" W	8 lb

### Pylon Mount

The Pylon Mount is designed for anchoring various models of the TUF-Lugger™ Lite directly to a pylon's angle iron. The most common usage is for lifting with the Vertical Pull Support (42200-050). It is easily anchored by one person with the help of built-in magnets.



Part No.	Material	Dimensions	Weight
42200-085	Powder coated steel	13" L x 11" W	17 lb

### Floor Mount













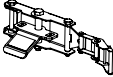
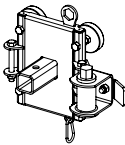



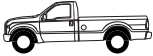



The Floor Mount is designed for anchoring the TUF-Lugger™ Lite to a concrete floor. The most common usage is for pulling wires inside a building. It can also be used outside when no other anchor point is available.

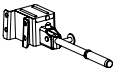

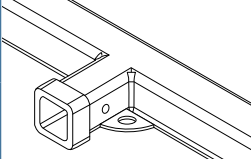
Part No.	Material	Dimensions	Weight
42200-080	Zinc plated steel	20" L x 11" W	21 lb

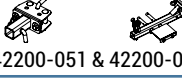
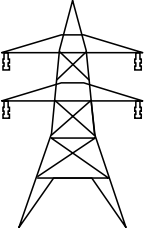
## Anchor Options Chart

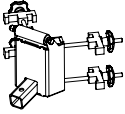
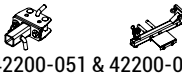
No matter what job you're using the TUF-Lugger™ Lite for, there is an anchor that will suit your application. The guide below is to show you the different options available for your anchor options.

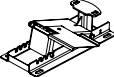
Anchoring Accessories Reference Chart			Use		TUF-Lugger Lite™ Models						
Anchor Points			Anchor Accessories		Pulling	Lifting	41000-200	41000-300	41000-400	41000-500	41000-600
 Cylindrical (tree, post, pole, etc.)	42300-206 42300-208 42300-210 		●		●	●	●	●	●	●	
	42200-015 		●		●	●					
	 42200-040	+ 42200-010 		●		●	●				
		+ 42200-050 			●			●	●	●	
+ 42200-051 & 42200-050 		●		●	●	●	●	●			
 Vehicle	1-7/8" to 2-5/16" Diameter 	42200-030 		●		●	●				
		42200-030 		●		●	●				
	With Tow Ball 	2" Diameter	+ 42200-010 		●		●	●			
			42200-035 			●			●	●	
			42200-025 		●		●	●	●	●	
	Hitch for square tube of 2" opening 		42200-020 		●		●	●			
	42200-021 			●			●	●	●		
+ 42200-051 & 42200-050 		●		●	●	●	●	●			
 Pylon (with 90° V-shaped legs)	+ 42200-010 		●		●	●					
	42200-085 			●			●	●	●		
	+ 42200-051 & 42200-050 		●		●	●	●	●	●		
 Floor	42200-080 		●		●	●					



## TUF-Lugger Lite Meter Box Puller Kit

This kit is designed to install conductor or communications cable through underground conduit to the meter box or the network interface box. The kit comes with 2" and 3" adaptors to allow a direct fit into the conduit and provide a high speed power assisted pull that prevents strain or injury while at the same time increases productivity. The kit is easily disassembled for transport to and from the work site and for storage. The durable construction of this kit make it strong enough to pull over 2,000 lb and can be used by a single operator.

This is to be used with the TUF-Lugger™ Lite models: 41000-200, 41000-300, 41000-400, 41000-500, and 41000-600.

Note: For customers that already have the Vertical Pull Support (42200-050), the kit contents are also sold as separate pieces.



Part No.	Quantity	Description	Weight
42200-050	1	Vertical Pull Support	15 lb
42200-060	1	Meter Box Puller with 2" & 3" Adapters	26 lb
42000-500KT	1	TUF-Lugger™ Lite Meter Box Puller Kit	41 lb

## Tripod for TUF-Lugger Lite Meter Box Puller Kit

The Tripod for TUF-Lugger™ Lite Meter Box Puller Kit is intended for use with the Meter Box Puller for TUF-Lugger™ Lite (42200-060), Vertical Pull Support (42200-050) and the TUF-Lugger™ Lite cable pullers (41000 series). Complete assembly is required as shown prior to use. Rope is intended to allow for an upward pull from a manhole, well, or conduit. Use of the safety cable (included) will ensure a secure and reliable setup for pulling up to 2,200 lb.



Part No.	Quantity	Description	Weight
42200-070	1	TUF-Lugger™ Lite Tripod Legs	28.5 lb
42000-600KT*	1	TUF-Lugger™ Lite Tripod Kit	70 lb

\* TUF-Lugger Lite™ sold separately.

## Stainless Steel Blocks

Blocks can be used when you need to alter the rope's direction, or if you're looking to increase your winch's overall pulling power by creating a double, triple, or quadruple rope setup.



Part No.	Description	Diameter	Minimum Rope Size	Maximum Rope Size	Weight
42400-104	Single Swing Side Snatch Block	4"	1/4"	1/2"	2.5 lb
42400-204	Double Swing Side Snatch Block	4"	1/4"	1/2"	4.0 lb

## Aluminum Self-Blocking Pulleys

Self-Blocking Pulleys are used during pulls in a rescue situation or a pull up an embankment or incline. It provides a safety backup by allowing the rope to pass only in the direction of the anchor, and locks when there is tension added in the other direction.



Part No.	Description	Diameter	Minimum Rope Size	Maximum Rope Size	Weight
42410-104	Swing Side Self-Blocking Pulley	2-1/2"	1/4"	1/2"	1.5 lb
42410-204	Double Swing Side Self-Blocking Pulley	2-1/2"	1/4"	1/2"	2.0 lb

## Locking Carabiners

Locking Carabiners have a multitude of uses. They can be used to quickly and easily attach blocks and pulleys to slings so that they can be anchored, to attach rope to a hook with a grommet if too small for the rope's diameter, or even as a feed guide attached to one's belt to guide rope into a rope bag.



Part No.	Material	Minimum Breaking Strength	Gate Opening	Weight
42420-010	Zinc plated with anodized aluminum	5,500 lb	5/8"	0.35 lb
42420-015	Zinc plated with anodized aluminum	11,250 lb	3/4"	1.39 lb
42420-020	Zinc plated with anodized aluminum	15,500 lb	1"	0.77 lb

## Hooks

Multipurpose hooks can be used for a variety of things. If the rope size is too large to fit into the hook's grommet, then attach a carabiner between the hook and the rope and use a bowline knot to attach the carabiner to the rope.



Part No.	Description	Material	Use	Hook Size	Grommet Size	Maximum Load	Weight
42430-020	Safety Hook	Powder coated steel	Pulling/Lifting	5/16"	11/16"	1,650 lb	0.73 lb
42430-030	Grab Hook with latch & chain links	Zinc plated steel	Pulling	5/16"	15/32"	4,500 lb	1.39 lb
42430-040	C-Hook for chain	Powder coated steel	Pulling	1/4" to 5/16"	3/8"	4,500 lb	0.75 lb

## Skidding Cone

This heavy duty Skidding Cone makes it easy to pull large logs or bunches of smaller logs over obstacles and brush. It is made of polymer plastic and is strong but flexible.



Part No.	Material	Dimensions	Maximum Diameter	Weight
42500-010	High-resistance polymer plastic	25" L x 21" W x 27" H	20"	15.0 lb

## TUF-Lugger™

The DCD TUF-Lugger™ is a cable puller that is designed to accommodate most pulling requirements up to a 5,500 lb load.

The unit is fully assembled and is mounted on four wheels making it portable and easy to move into any pulling location. It includes a foot pedal start/stop switch, four duct guides to suit 2", 3", 3-1/2", and 4" Schedule 40 duct, and a steel tool box carrying case.

The TUF-Lugger™ is driven by a removable TUF-Lugger™ Lite (41000-500), which can also be used for other applications. The frame is fitted with a feed-out sheave, which allows the operator to stand clear of the line of pull. An optional load cell indicator with monitoring software can also be installed.

There are two arms which combine to allow access to both overhead and underground ducting.

Note: This product is not to be used for any purpose other than pulling cable through conduit. A duct guide must always be used in order to lock the unit into position – without this, it is possible or likely that the entire unit will lift off the floor and may cause damage or severe injury.



Part No.	Description	Power Info	Maximum Pulling Force	Maximum Speed	Work Cycle	Maximum Height Reach	Weight
42600-000	TUF-Lugger™ Cable Pulling Device	115V, 10 amp (Requirement)	5,500 lb	9.3' per minute	15 minutes per hour	6-1/2'	237 lb
40000-001	Voltage Converter (220V to 110V)	3,000 watts (Limit)	-	-	-	-	27 lb

The basic TUF-Lugger™ has many features not normally found on this type of puller:

**Rope Deflector Sheave:** In the event that the rope should break, the tension in the rope could cause severe injury. With the deflector sheave, the operator may stand well clear of the pulling equipment and in particular, the line of pull.

**Open-sided Duct Guides:** These allow insertion or removal from the pull at any time. It should also be noted that the sheave is positioned immediately above the duct guide always ensuring that the rope or cable does not drag along the edge of the duct. The open side also allows positioning of the duct guide right up against a wall or junction box.

**Extendable Arms:** The outer beam of the TUF-Lugger™ is made up of 2" Schedule 40 aluminum pipe. Contact Customer Service for extensions to reach up to higher locations or into manholes, etc.

**Single Speed Simplicity:** The TUF-Lugger™ is powered by the TUF-Lugger™ Lite (41000-500). The smooth capstan allows the operator to reduce tension at the rope deflector sheave and slip the rope to reduce pulling speed without shredding the rope. For better slipping and lower loads, fewer wraps around the capstan may be used.

**Fine Indexing:** The duct guides can be indexed in 7-1/2 degree increments in order to allow better alignment with the duct opening. In addition, there are 2 separate pins that hold the duct guide in position. They are short pins located from either side to allow unimpeded passage of the rope or cable.

**Well Balanced Design:** The TUF-Lugger™ requires no field assembly and allows for easy fold down of the unit for pushing or pulling by hand. A minimum amount of force is required to tip the unit onto two wheels for steering or turning in tight areas.

All the above features are standard, but there is more – chrome plated shafts and iron-bronze bushings on all sheaves, brass serial number plate on every unit, heavy duty chains on the sprocket drives, powder coated paintwork, stainless steel securing pins at all elbows and more.

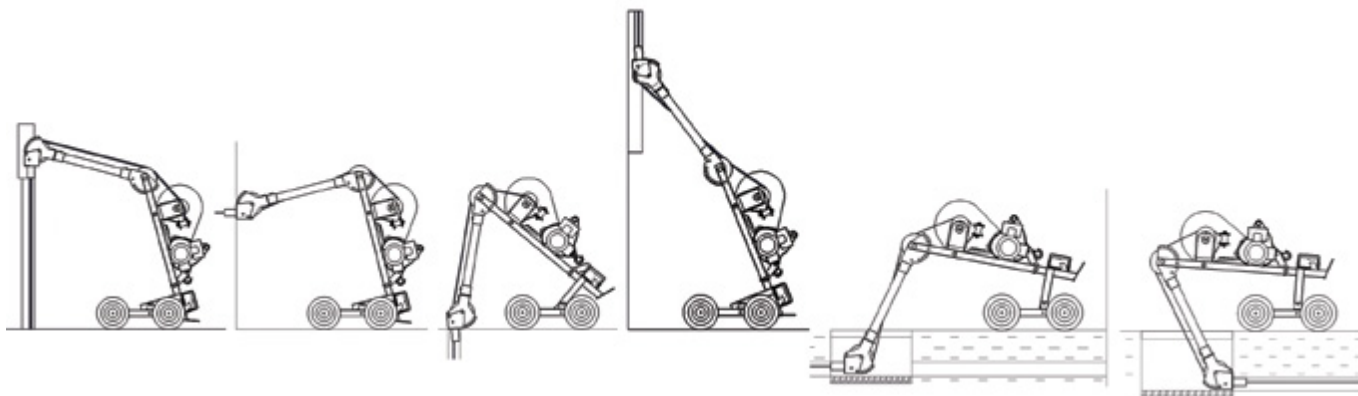

## TUF-Lugger™ Manhole Adapter

The Manhole Adapter is designed to straddle the open manhole and provide an anchor point for the TUF-Lugger™. It has two tabs that locate inside the manhole for safety. These are easily adjustable without the need for any tools or wrenches.

The "bridge" through which the cable is pulled slides easily along the length of the adapter allowing easy positioning to match the cable location. In the event of difficulties during the pull, the entire unit can be assembled around or removed from already positioned pull rope or cable.

The unit is mostly aluminum and is lightweight and easy to handle. A 6" duct guide (40010-600, not included) must be used to locate the TUF-Lugger™ in the Manhole Adapter.



Part No.	Manhole Size Range	Materials	Weight
40000-300	18" to 36"	Aluminum, Polyurethane	63 lb

## Universal Extension

The Universal Extension frame is designed to get to those really hard to reach corners and still be able to locate the duct guide squarely into the ducting.

It mounts directly onto the end of the standard TUF-Lugger™ with all the existing hardware that comes with the TUF-Lugger™. The unit has the ability to be rotated 90 degrees in either direction thus giving total flexibility inside a manhole to reach any location. The Universal Extension is provided with short aluminum tubes, but it is likely that they will not be suitable for all applications. It is up to the contractor to obtain 2" pipes of a length to suit any particular application.

The outboard end of the extension is identical to that of the TUF-Lugger™ thus allowing the normal use of the duct guides.

It is possible to assemble more than one of these extensions such that when coupled together, they provide the ability to fully turn a corner.

Care must be taken when assembling this extension because until load is put onto the TUF-Lugger™, the entire unit will be very unstable – once load is applied, all the arms will tighten up under the tension and it will again become stable.



Part No.	Overall Length	Weight
40000-500	41-5/16"	43 lb

## Floor Mounting Frame

The duct guides are designed to locate inside the ducting and provide an anchor point for the TUF-Lugger™ to pull against. These and all other units are also available individually. Each duct guide has mounting holes for attachment to the last sheave on the TUF-Lugger™.

The assembly of the duct guide to the TUF-Lugger™ is reversed for upward direction as opposed to downward direction. Each unit also has a pair of holes used for indexing the position of the guide in increments of 7-1/2 degrees. All DCD duct guides are open on one side to allow easy installation or removal without feeding over the cable or pulling rope.



Part No.	Securing Bolt Type	Securing Bolt Pattern	Weight
40000-400	5/8" Hilti Bolts	32" x 12"	19 lb

## TUF-Lugger™ Duct Guides

The duct guides are designed to locate inside the ducting and provide an anchor point for the TUF-Lugger™ to pull against. These and all other units are also available individually. Each duct guide has mounting holes for attachment to the last sheave on the TUF-Lugger™.

The assembly of the duct guide to the TUF-Lugger™ is reversed for upward direction as opposed to downward direction. Each unit also has a pair of holes used for indexing the position of the guide in increments of 7-1/2 degrees. All DCD duct guides are open on one side to allow easy installation or removal without feeding over the cable or pulling rope.



Part No.	Duct Guide Size	Weight
40010-200*	2"	5.23 lb
40010-250	2-1/2"	5.31 lb
40010-300*	3"	5.60 lb
40010-350*	3-1/2"	5.94 lb
40010-400*	4"	6.28 lb
40010-500	5"	8.23 lb
40010-600	6"	8.50 lb

\* Included with TUF-Lugger™ (42600-000).



## Fiber Cable Puller

The Fiber Cable Puller is a simple, easy to use cable puller that is designed to accommodate industry standard sheaves of 7-1/4", 30", or 42" dia. specifically intended for use with fiber optic cables requiring a minimum bend radius.

The unit is powered by the TUF-Lugger™ Lite Lifting - Gas (41000-400) or by the TUF-Lugger™ Lite Lifting - Electric (41000-500), providing a gas or electric option as a simpler, lighter, less costly option than a typical hydraulic puller.

Best of all, the Fiber Cable Puller is assembled using the Vertical Pull Support (42200-050) and the TUF-Lugger™ Lite (41000 series), which includes the standard capstan. Simply dismount the winch and install the standard capstan and the winch can be used as a stand-alone item, which comes with a 2-1/4" capstan providing a 2,200 lb pulling force.



### Standout Features

- 30" and 42" capstan drums are compatible with Bull-Line™ Pull Tape.
- Easily Disassembled with simple tools; each component weighs less than 74 lb.
- Base frame legs are removable for compact storage. They also include adjustable pads for levelling on hard surfaces.
- Frame clearance allows a vertical pull out of a manhole or well.
- Holes in base frame allow frame to be pegged or bolted to the ground.
- Controlled using cable actuated foot pedal, allowing operator both hands to handle rope.
- Vertical Pull Support (42200-050, included) is compatible with 2" square tubing adapter, making unit hitch mountable.

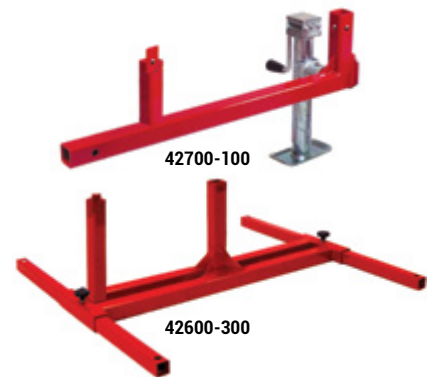
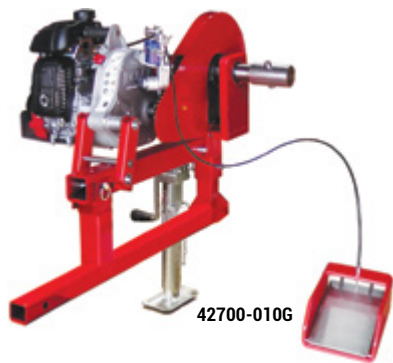

### Fiber Cable Puller Assemblies

Part No.	Description	Weight
42700-000G	Fiber Cable Puller (Gas) w/ H-Frame Base	204 lb
42700-000E	Fiber Cable Puller (Electric) w/ H-Frame Base	215 lb
42700-010G	Fiber Cable Puller (Gas) w/ Hitch Base	175 lb
42700-010E	Fiber Cable Puller (Electric) w/ Hitch Base	186 lb

### Capstan Drums

Part No.	Description	Weight
40030-070	7-1/4" Capstan Drum	30 lb
40030-300	30" Capstan Drum	75 lb
40030-400	42" Capstan Drum	105 lb

### Base Options

Part No.	Description	Weight
42700-100	Hitch Mount for Fiber Cable Puller	37 lb
42600-300	H-Frame Base for Fiber Cable Puller	65 lb

### Specifications

Part No.	Engine	Power Requirement	Work Cycle	Clutch	Maximum Pulling Force				Maximum Pulling Speed			
					2-1/4" Capstan	7-1/4" Capstan	30" Capstan	42" Capstan	2-1/4" Capstan	7-1/4" Capstan	30" Capstan	42" Capstan
42700-000G (Gas)	4-Stroke Honda GXH-50cc	-	100% Continuous Work	Centrifugal Clutch	2,200 lb	2,933 lb	880 lb	660 lb	40' per minute	34' per minute	114' per minute	152' per minute
42700-000E (Electric)	AC Electric Baldor TEFC 60 Hz	110V 10 AMP	75% Work Cycle *	N/A (Direct Drive)	1,800 lb	2,200 lb	675 lb	500 lb	40' per minute	19' per minute	64' per minute	85' per minute

\* 15 minutes per hour recommended cool down period.

## Duct Rodder Introduction

DCD offers one of the most comprehensive range of Duct Rodders available anywhere in the world - from the smallest 3/16" dia. Reel Rod to the rugged 1/2" Duct Rodders.

### The Rod

DCD's rods are manufactured from premium materials formulated to offer the high performance and durability demanded by our customers.

The core of the rod is manufactured by the pultrusion process. This involves impregnating high strength continuous glass fiber filaments with a liquefied resin. The fibers are drawn in to a heated die where the resin matrix is cured, bonding the fibers together and allowing mechanical loads to be transmitted through the matrix and distributed amongst the fibers.

The resulting pultruded rod combines both the high stiffness required to push the rod through long distances of ducting, with the flexibility to handle tight bends without damage. This inner core is then coated with a highly durable, scratch resistant polypropylene sheath which protects the core from mechanical damage.

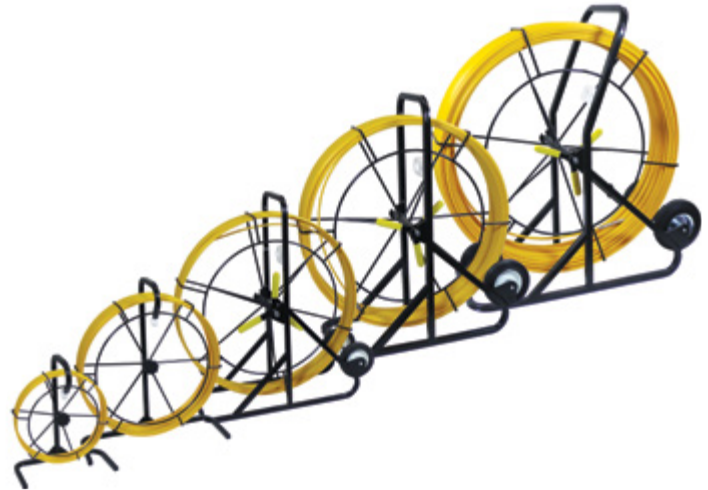

### The Frames

Frames are also a feature of the DCD systems. The four largest sizes incorporate the new EZ-Tip™ feature, a larger footprint for stability, steel brake handles that will last forever, dual rod out-feeding positions, and wheels inside the frame width. The two smallest sizes feature reinforced frames with the feedout built into the handle. All frames can be laid down on either side. These are just some of the design features that will make every unit more usable and friendly for the end user.

### Rod Selection

Which is the right rod diameter for any given application? The rod selection is usually governed by several factors, including:

- The size of ducting it is to be pushed through
- The distance the rod is to be pushed
- The number and tightness of bends in the ducting
- If the ducting is already occupied by cable

When being pushed through the duct, any rod will tend to form "sine waves", hitting the wall of the duct at certain intervals. Each time the rod comes in contact with the wall of the duct, it causes friction. The friction will build and eventually prevent the rod from being pushed any further. Small rod in large duct will make a higher pressure contact with the ducting; the same rod in smaller duct will make less pressure on contact and therefore less friction, so it can be pushed further. Large rod in small ducting is a good situation, but reduced flexibility of the rod may cause increased friction in the tighter bends.

The chart below is a rough guide for rod diameter selection, but all of the above factors should be taken into consideration before making the final selection.

Rod Diameter	Threaded Connection	Tensile Strength of Rod	Typical Strength of Glued Connection	Typical Strength of Screwed Connection	Minimum Bend Radius	Typical Maximum Duct Diameter	Maximum Length of Push or Pull
3/16"	#12 UNC	2,200 lb	350 lb	-	4"	2"	300'
1/4"	5/16" UNC	4,070 lb	800 lb	1,050 lb	7"	2-1/2"	400'
5/16"	5/16" UNC	7,700 lb	850 lb	1,100 lb	10"	3"	600'
3/8"	3/8" UNC	8,580 lb	1,150 lb	1,150 lb	12"	4"	800'
7/16"	3/8" UNC	11,000 lb	1,750 lb	1,200 lb	16"	8"	1,200'
1/2"	3/8" UNC	13,000 lb	1,900 lb	1,250 lb	18"	10"	1,000'

**NOTE: All Duct Rodders are custom built to order and are non-returnable unless under warranty. All Replacement Rods will be shipped in a new cage for easy replacement onto the frame. Extreme care must be taken when handling loose fiberglass rod as it stores considerable energy and may cause severe injury.**

## Detectable Duct Rods

DCD Detectable Duct Rodders are available in 3/16", 5/16", and 7/16" diameter rods. They are available in the same lengths as the regular rodders and are mounted in the same frames. The purpose of the detectable rod is to be able to accurately locate existing ducting underground or to locate the position of a blockage within a duct.

Each DCD detectable duct rod unit is supplied with a terminal box mounted on the frame with male and female banana terminals for external hook up.

It is recommended that a Roller Guide (57150 series) be used in order to better make the connection between the end of the rod and the wall of the ducting. This is necessary in order to complete the circuit back to earth.

Any transmitter can then be hooked up to the terminal box with the second lead from the transmitter going to ground (spike into earth). Once switched on, the signal will be transmitted along the duct rod and a standard locator can then be used to locate the signal source from above ground.

DCD also offers various stainless steel Sonde Adapters (57170 series) for attaching a sonde unit to the Swivel Rod End (57135 series).

The Detectable Duct Rodders use 20 to 25 gauge copper wire.

Note: Caution should be exercised when ordering long lengths because the signal will diminish with distance traveled.



## Reel Rod - 3/16" Diameter

The Reel Rod has a sturdy, powder coated, steel tube frame and features a 16" diameter storage basket. Up to 400' of rod can be stored in this basket. A light adjustable brake prevents the rod from reeling out of the basket under its own tension. The Reel Rod and the Fish Rod (51000 series) share common screw threads, allowing the use of the same accessories.

The standard Reel Rods include a male rod end and a pulling eye. The deluxe version includes accessories as listed below.

Although the fiberglass rods have very high reliability, improper handling can cause the rod to break. In these instances, repair is simple and can be carried out by any user.

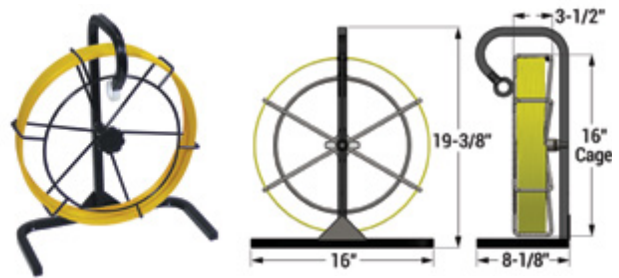

Deluxe 3/16" Rod	Deluxe Detectable Rod	Replacement Regular Rod	Replacement Detectable Rod	Rod Length	Weight	Deluxe Rod Accessories	Replacement Frame
52000-150	52200-150	52100-150	52400-150	150'	7.0 lb	Splice Connectors (2) Flexible Guide Head (1) Roller Guide (1) Male Rod End (1) Fiberglass Adhesive (1) Rod Gripper (1) Accessory Pouch (1)	52300-000
52000-200	52200-200	52100-200	52400-200	200'	10.0 lb		
52000-250	52200-250	52100-250	52400-250	250'	10.5 lb		
52000-300	52200-300	52100-300	52400-300	300'	11.0 lb		
52000-350	52200-350	52100-350	52400-350	350'	11.5 lb		
52000-400	52200-400	52100-400	52400-400	400'	12.0 lb		
52000-500	52200-500	52100-500	52400-500	500'	13.0 lb		

Note: For Standard Rodder units that do not include accessories shown above, add 'X' to the part number.

**EXTREME CAUTION: Never use a Detectable Rodder in a live electrical environment. Electrical shock or death may result if conductive rod touches an exposed circuit.**

## Tuf Rod - 1/4" Diameter

This unit is mounted in a convenient frame with carrying handle similar to, but larger than the 3/16" unit and the rod is housed in a 24" diameter storage basket. The end fittings are the same as those offered with the slightly larger 5/16" rod – all stainless steel and with DCD's unique design allowing the fittings to be attached by either screwing or gluing onto the rod core. Thread sizes for all connections are 5/16" UNC.

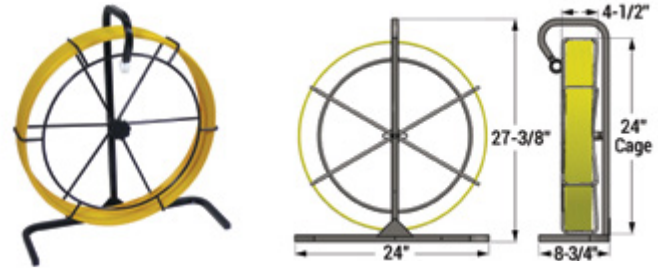

Minimum bend radius is 7" and sizes available are from 150' up to 500'. DCD does not recommend pushing lengths over 500' unless in relatively small ducting 2" dia. or smaller. Standard Rodders come complete with stainless steel swivel rod end, female rod end and a pulling eye, while the deluxe version includes accessories as listed below.

Deluxe 1/4" Rod	Replacement Regular Rod	Rod Length	Weight	Deluxe Rod Accessories	Frame Replacement
52500-150	52600-150	150'	12 lb	Splice Connector (1) Flexible Guide Head (1) Roller Guide (1) Clevis End (1) Fiberglass Adhesive (1) Rod Gripper (1) Accessory Pouch (1)	52700-000
52500-200	52600-200	200'	13 lb		
52500-250	52600-250	250'	14 lb		
52500-300	52600-300	300'	15 lb		
52500-350	52600-350	350'	16 lb		
52500-400	52600-400	400'	17 lb		
52500-500	52600-500	500'	19 lb		
52500-600	52600-600	600'	22 lb		

Note: For Standard Rodder units that do not include accessories shown above, add 'X' to the part number.

## Ruf Rod - 5/16" Diameter

The 5/16" Ruf Rod is one of the most popular sizes because of its versatility in both small and medium size ducts. It is the smallest of the wheel frames and at well under 3' in height or length, it is easy to store or load onto your vehicle.

Although DCD only recommends lengths up to 800', the standard cage will hold up to 1,000'. The longer lengths should only be used in smaller ducts (up to 2-1/2" dia.) and when there are few bends. The standard unit includes a female rod end, a swivel rod end and a pulling eye. The deluxe version includes accessories as listed below. All accessories that attach to the rod can be glued in the traditional manner or can be clamped with set screws. For extra security, they can be both glued and clamped.



Deluxe 5/16" Rod	Deluxe Detectable Rod	Replacement Regular Rod	Replacement Detectable Rod	Rod Length	Weight	Deluxe Rod Accessories	Frame Replacement
53500-200	53700-200	53600-200	53800-200	200'	32 lb	Splice Connector (1) Flexible Guide Head (1) Roller Guide (1) Clevis End (1) Fiberglass Adhesive (1) Rod Gripper (1) Accessory Pouch (1)	53900-000
53500-250	53700-250	53600-250	53800-250	250'	34 lb		
53500-300	53700-300	53600-300	53800-300	300'	36 lb		
53500-350	53700-350	53600-350	53800-350	350'	38 lb		
53500-400	53700-400	53600-400	53800-400	400'	40 lb		
53500-500	53700-500	53600-500	53800-500	500'	44 lb		
53500-600	53700-600	53600-600	53800-600	600'	48 lb		
53500-700	53700-700	53600-700	53800-700	700'	52 lb		
53500-800	53700-800	53600-800	53800-800	800'	56 lb		
53500-900*	53700-900*	53600-900	53800-900	900'	60 lb		
53500-1000*	53700-1000*	53600-1000	53800-1000	1,000'	64 lb		

\* These lengths require the full capacity of the frame and are difficult to rewind into the cage without due care and attention to the layering of the rod.

Note: For Standard Rodder units that do not include accessories shown above, add 'X' to the part number.

**EXTREME CAUTION: Never use a Detectable Rodder in a live electrical environment. Electrical shock or death may result if conductive rod touches an exposed circuit.**



## Ruf Rod - 3/8" Diameter

The 3/8" Ruf Rod features a 34" diameter storage basket which comfortably stores up to 800' of fiberglass rod. The Standard Ruf Rods include a female rod end, a swivel rod end, and a pulling eye. The deluxe version includes accessories as listed below.

All accessories that attach to the rod can be glued in the traditional manner or can be clamped with set screws. For extra security, they can be both glued and clamped.



Deluxe 3/8" Rod	Replacement Regular Rod	Rod Length	Weight	Deluxe Rod Accessories	Frame Replacement
54000-200	54100-200	200'	49 lb	Splice Connector (1) Flexible Guide Head (1) Roller Guide (1) Clevis End (1) Fiberglass Adhesive (1) Rod Gripper (1) Accessory Pouch (1)	54200-000
54000-300	54100-300	300'	55 lb		
54000-400	54100-400	400'	61 lb		
54000-500	54100-500	500'	67 lb		
54000-600	54100-600	600'	73 lb		
54000-700	54100-700	700'	79 lb		
54000-800	54100-800	800'	85 lb		
54000-900*	54100-900	900'	91 lb		
54000-1000*	54100-1000	1,000'	97 lb		

\* These lengths require the full capacity of the frame and are difficult to rewind into the cage without due care and attention to the layering of the rod.  
 Note: For Standard Rodder units that do not include accessories shown above, add 'X' to the part number.

## Ruf Rod - 7/16" Diameter

The 7/16" Ruf Rod features our largest frame with a 40" diameter storage basket, which can hold up to 1500' of 7/16" fiberglass rod.

The standard Ruf Rods include a female rod end, a swivel rod end, and a pulling eye. The deluxe version includes accessories as listed below.

All accessories that attach to the rod can be glued in the traditional manner or can be clamped with set screws. For extra security, they can be both glued and clamped.

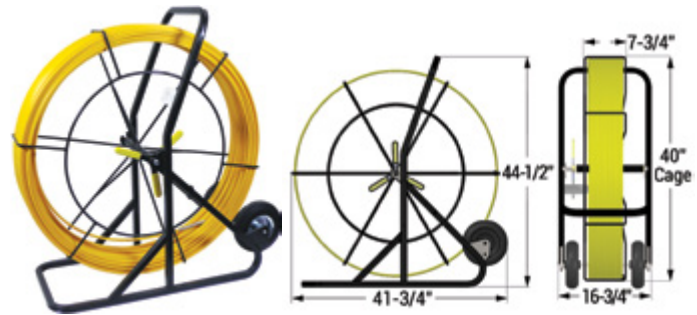

Deluxe 7/16" Rod	Deluxe Detectable Rod	Replacement Regular Rod	Replacement Detectable Rod	Rod Length	Weight	Deluxe Rod Accessories	Frame Replacement
56000-400	56200-400	56100-400	56300-400	400'	84 lb	Splice Connector (1) Flexible Guide Head (1) Roller Guide (1) Clevis End (1) Fiberglass Adhesive (1) Rod Gripper (1) Accessory Pouch (1)	56300-000
56000-500	56200-500	56100-500	56300-500	500'	94 lb		
56000-600	56200-600	56100-600	56300-600	600'	104 lb		
56000-700	56200-700	56100-700	56300-700	700'	114 lb		
56000-800	56200-800	56100-800	56300-800	800'	124 lb		
56000-900	56200-900	56100-900	56300-900	900'	134 lb		
56000-1000	56200-1000	56100-1000	56300-1000	1,000'	144 lb		
56000-1100	-	56100-1100	-	1,100'	154 lb		
56000-1200	-	56100-1200	-	1,200'	164 lb		
56000-1300	-	56100-1300	-	1,300'	174 lb		
56000-1400*	-	56100-1400	-	1,400'	184 lb		
56000-1500*	-	56100-1500	-	1,500'	194 lb		

\* These lengths require the full capacity of the frame and are difficult to rewind into the cage without due care and attention to the layering of the rod.  
 Note: For Standard Rodder units that do not include accessories shown above, add 'X' to the part number.

**EXTREME CAUTION: Never use a Detectable Rodder in a live electrical environment. Electrical shock or death may result if conductive rod touches an exposed circuit.**

## Ruf Rod - 1/2" Diameter

The 1/2" Ruf Rod completes the range of DCD Duct Rodders. The storage basket is the same as the for the 7/16" rod at 40" diameter and can store up to 1000' of the 1/2" fiberglass rod.

The standard Ruf Rods include a female rod end, a swivel rod end and a pulling eye. The deluxe version includes accessories as listed below. All accessories that attach to the rod can be glued in the traditional manner or can be clamped with set screws. For extra security, they can be both glued and clamped.



Deluxe 1/2" Rod	Replacement Regular Rod	Rod Length	Weight	Deluxe Rod Accessories	Frame Replacement
56500-400	56600-400	400'	107 lb	Splice Connector (1) Flexible Guide Head (1) Roller Guide (1) Clevis End (1) Fiberglass Adhesive (1) Rod Gripper (1) Accessory Pouch (1)	56300-000
56500-500	56600-500	500'	120 lb		
56500-600	56600-600	600'	134 lb		
56500-700	56600-700	700'	147 lb		
56500-800	56600-800	800'	161 lb		
56500-900*	56600-900	900'	175 lb		
56500-1000*	56600-1000	1,000'	188 lb		
56500-1200*	56600-1200	1,200'	215 lb		

\* These lengths require the full capacity of the frame and are difficult to rewind into the cage without due care and attention to the layering of the rod.  
 Note: For Standard Rodder units that do not include accessories shown above, add 'X' to the part number.

## Duct Rodder Accessories

All Duct Rodders are offered in standard or deluxe packages. Separate accessory kits are available with contents listed in the table below.

The larger 5/16", 3/8", 7/16" and 1/2" Rodders are supplied with stainless steel accessories and all components attaching directly to the rod are designed to be glued on in the traditional manner or can be attached by means of four clamping set screws or can be both glued and screwed. The accessories supplied on the product at the factory are attached by screws only and can be glued by the customer if required.

The obvious advantage of the clamping system is that repairs or product changes can be carried out easily in the field with no time delay to allow the glue to dry. Spare set screws and hexagon keys are also supplied.

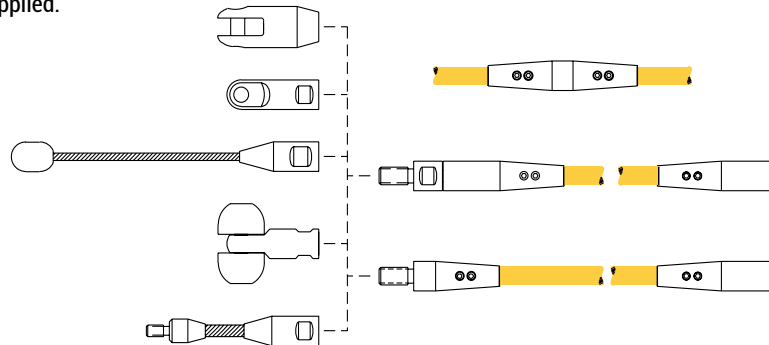

## Accessory Kits

Accessory Kit Part No.	For Rod Diameter	Male Rod End (57135)	Splice Connector (57100)	Flexible Guide Head (57110)	Roller Guide (57150)	Clevis End (57160)	Fiberglass Adhesive (57170)	Rod Gripper (57170)	Accessory Pouch (57170)
57000-001	3/16"	1	2	1*	1	-	1	1	1
57000-003	1/4"	-	1	1	1	1	1	1	1
57000-005	5/16"	-	1	1	1	1	1	1	1
57000-004	3/8"	-	1	1	1	1	1	1	1
57000-006	7/16"	-	1	1	1	1	1	1	1
57000-007	1/2"	-	1	1	1	1	1	1	1

\* Refers to 57110-001.

## Splice Connectors

These products are used to repair a break in the rod. Having a solid section in the middle of the rod may cause problems with bending at that point and care should be taken when winding rod with a solid connector. The five larger sizes are stainless steel and can be glued or screwed on, the two smaller sizes are brass and must be glued.

Part No.	For Rod Diameter	Weight
57100-001	3/16"	0.01 lb
57100-003	1/4"	0.09 lb
57100-005	5/16"	0.09 lb
57100-004	3/8"	0.14 lb
57100-006	7/16"	0.14 lb
57100-007	1/2"	0.14 lb

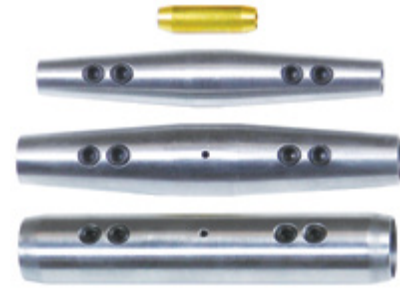

## Non-Metallic Splice Connectors for Detectable Rodders

Like the 57100 Series, these products are used to repair a break in the rod, but this new 57101 Series is made from non-metallic material, allowing it to be used with our Detectable Rodders. Available in three sizes.

Part No.	For Rod Diameter	Weight
57101-001	3/16"	0.02 lb
57101-005	5/16"	0.04 lb
57101-006	7/16"	0.06 lb



## Flexible Guide Heads

Flexible Guides are used for leading the rod around tight bends. The two larger sizes are stainless steel, the smaller sizes are brass.



Part No.	For Rod Diameter	Head Diameter	Overall Length	Threaded Connection	Weight
57110-000	3/16"	5/16"	3-1/2"	#12 UNC	0.02 lb
57110-001	3/16"	3/8"	3-1/2"	#12 UNC	0.03 lb
57110-002	1/4", 5/16"	9/16"	6"	5/16" UNC	0.11 lb
57110-004	3/8", 7/16", 1/2"	3/4"	12"	3/8" UNC	0.27 lb

## Pulling Eyes

Pulling Eyes are used for tying wire or pull tape to the end of the rod or used as a leader. They screw directly onto the rod end and are supplied with the rodder.



Part No.	For Rod Diameter	Body Diameter	Threaded Connection	Weight
57120-000	3/16"	1/4"	#12 UNC	0.01 lb
57120-001	3/16"	3/8"	#12 UNC	0.02 lb
57120-002	1/4", 5/16"	1/2"	5/16" UNC	0.05 lb
57120-004	3/8", 7/16", 1/2"	5/8"	3/8" UNC	0.27 lb

## Rod Ends

These are used as a means of attaching accessories to the rod. Male rod ends are standard on the leading end of the smaller 3/16" rodders, which have no fitting on the back end. The larger rodders are all fitted with female ends on the back end of the rod.



Female Rod End Part No.	Male Rod End Part No.	For Rod Diameter	Body Diameter	Threaded Connection	Weight
-	57135-001	3/16"	1/4"	#12 UNC	0.01 lb
57130-003	57135-003	1/4"	1/2"	5/16" UNC	0.07 lb
57130-005	57135-005	5/16"	1/2"	5/16" UNC	0.07 lb
57130-004	57135-004	3/8"	5/8"	3/8" UNC	0.13 lb
57130-006	57135-006	7/16"	5/8"	3/8" UNC	0.13 lb
57130-007	57135-007	1/2"	5/8"	3/8" UNC	0.13 lb

## Swivel Connectors

The Swivel Connector allows any attachment to the rod to rotate freely. These have bronze bearings and are supplied as standard on all 1/4" and larger rodders.



Part No.	For Rod Diameter	Body Diameter	Threaded Connection	Weight
57140-003	1/4"	1/2"	5/16" UNC	0.10 lb
57140-005	5/16"	1/2"	5/16" UNC	0.10 lb
57140-004	3/8"	5/8"	3/8" UNC	0.20 lb
57140-006	7/16"	5/8"	3/8" UNC	0.20 lb
57140-007	1/2"	5/8"	3/8" UNC	0.20 lb

## Roller Guides

The Roller Guide is used to push through conduit with cable already in place. The rollers prevent the rod from wedging in under the cable as they rotate on hardened shoulder bolts. The shank attaches directly to the swivel rod end to provide axial rotation. The Roller Guides are recommended for use with the detectable duct rods to make a better electrical connection with the walls of the ducting.

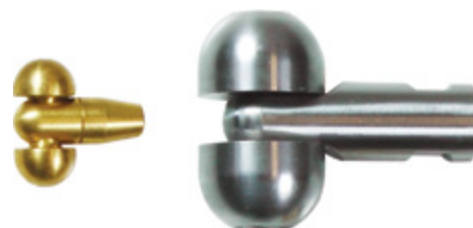

Part No.	For Rod Diameter	Body Diameter	Across Rollers	Threaded Connection	Weight
57150-001	3/16"	3/8"	1-1/16"	#12 UNC	0.05 lb
57150-002	1/4", 5/16"	1/2"	1-3/16"	5/16" UNC	0.14 lb
57150-004	3/8", 7/16", 1/2"	5/8"	1-11/16"	3/8" UNC	0.34 lb

## Clevis Ends

The Clevis allows attachment of pulling ropes, etc. without the need of extra shackles.





Part No.	For Rod Diameter	Body Diameter	Threaded Connection	Weight
57160-002	1/4", 5/16"	5/8"	5/16" UNC	0.08 lb
57160-004	3/16", 3/8", 7/16", 1/2"	7/8"	3/8" UNC	0.22 lb



## Sonde Connections

Other sizes may be available upon request.

Part No.	For Rod Diameter	Body Diameter	Threaded Connection	Weight	Type	
57131-003	1/4"	1/2"	Rod to M10x1.5 Female	0.06 lb	 Male Rod End Replacement	
57131-005	5/16"	1/2"	Rod to M10x1.5 Female	0.06 lb		
57131-004	3/8"	5/8"	Rod to M10x1.5 Female	0.12 lb		
57131-006	7/16"	5/8"	Rod to M10x1.5 Female	0.13 lb		
57131-007	1/2"	5/8"	Rod to M10x1.5 Female	0.13 lb		
57170-001	3/16"	1/2"	#12 UNC Female to 1/4" UNC Male	0.04 lb		 Rigid Adapter
57170-002	1/4", 5/16"	1/2"	5/16" Female to 1/4" UNC Male	0.04 lb		
57170-004	3/8", 7/16", 1/2"	5/8"	3/8" Female to 1/4" UNC Male	0.08 lb		
57170-007	3/8", 7/16", 1/2"	5/8"	3/8" Female to #12 Male	0.10 lb		
57170-011	3/8", 7/16", 1/2"	5/8"	3/8" UNC Female to 3/8" UNC Female	0.10 lb		
57170-014	3/16"	1/2"	#12 UNC Female to M10x1.5 Female	0.04 lb		
57170-015	1/4", 5/16"	5/8"	5/16" UNC Female to 3/8" UNC Male	0.10 lb		
57170-016	1/4", 5/16"	5/8"	5/16" UNC Female to 7/16" UNC Male	0.10 lb		
57170-021	3/16"	3/8"	#12 UNC Female to #12 UNC Female	0.04 lb		
57170-023	1/4", 5/16"	5/8"	5/16" UNC Male to 3/8" UNC Male	0.04 lb		
57170-024	3/16"	1/2"	#12 UNC Female to M5x0.8 Male	0.04 lb		
57170-028	1/4"	5/8"	1/4" UNC Female to 3/16" UNC Female	0.13 lb		
57170-030	3/8", 7/16", 1/2"	3/4"	3/8" Female to M12x1.75 Male	0.17 lb		
57170-003	1/4", 5/16"	1/2"	5/16" UNC Female to 1/4" UNC Male	0.10 lb		
57170-005	3/8", 7/16", 1/2"	5/8"	3/8" UNC Female to 1/4" UNC Male	0.13 lb		
57170-009	3/8", 7/16", 1/2"	5/8"	3/8" UNC Female to 3/8" UNC Male	0.14 lb	 Flexible Adapter	
57170-012	1/4", 5/16"	1/2"	5/16" UNC Female to M10x1.5 Female	0.10 lb		
57170-013	3/8", 7/16", 1/2"	5/8"	3/8" UNC Female to M10x1.5 Female	0.14 lb		
57170-017	1/4", 5/16"	5/8"	5/16" UNC Female to 5/16" UNC Male	0.14 lb		
57170-018	1/4", 5/16"	5/8"	5/16" UNC Female to 3/8" UNC Female	0.14 lb		
57170-019	3/8", 7/16", 1/2"	1/2"	M10x1.5 Female to M10x1.5 Male	0.13 lb		
57170-020	3/16"	1/4"	#12 UNC Female to M10x1.5 Female	0.11 lb		
57170-022	1/4", 5/16"	1/2"	5/16" UNC Female to M5x0.8 Female	0.11 lb		

## Rod Counter

The Rod Counter is made from welded steel and aluminum and is designed to count the fiberglass rod as it's spooled off the Duct Rodder frame. It fits all of our Standard and Detectable rodder frames and works with all our diameter rods, from the small and compact 3/16" diameter Reel Rod to the heavy duty 1/2" diameter Ruf Rod. Smaller rods (3/16" and 1/4") require the S-bar Frame Adapter.



Part No.	Description	Fits Frames	Weight
57180-000	Rod Counter (Imperial)	5/16" - 1/2"	2.0 lb
57180-005	Rod Counter (Imperial) with Frame Adapter *	3/16" - 1/2"	2.2 lb
57181-000	Rod Counter (Metric)	5/16" - 1/2"	2.3 lb
57181-005	Rod Counter (Metric) with Frame Adapter *	3/16" - 1/2"	2.5 lb

\* Frame Adapter only fits 3/16" and 1/4" frames.

## Miscellaneous

It's always good to have these extra products on hand when working with Duct Rodders.

Part No.	Description	Weight
57170-006	Rod Gripper (for all rod sizes)	0.09 lb
57170-008	Fiberglass Adhesive (3 g)	0.01 lb
57170-010	Loctite Adhesive 495 Super Bonder (1 oz. bottle)	0.06 lb



## Wire Mesh Grips for Duct Rodders

The smaller sized Wire Mesh Grips come with an already attached swivel while the three largest sizes simply have a pulling eye. In both cases, they will screw to the 3/16" diameter Rod ends. They are especially useful for pulling bundles of small wires in premise applications.



Part No.	Size Range	Approximate Breaking Strength	Weight
60000-066	0.16" to 0.24" dia.	250 lb	0.01 lb
60000-060	0.24" to 0.35" dia.	250 lb	0.02 lb
60000-061	0.35" to 0.47" dia.	250 lb	0.03 lb
60000-062	0.47" to 0.59" dia.	250 lb	0.03 lb
60000-063	0.59" to 0.75" dia.	250 lb	0.06 lb
60000-064	0.75" to 0.98" dia.	250 lb	0.10 lb
60000-065	0.98" to 1.20" dia.	250 lb	0.16 lb

## Hand Rodder

DCD Hand Rods are high quality fiberglass with brass end fittings that easily attach together with 3/4" - 10 UNC threads. Hand Rods are available in 5' or 10' lengths.



Part No.	Rod Diameter	Length	Weight
57500-010	5/8"	10'	3.0 lb

## Fiber Optic Cage

Originally designed for Optical Fiber Cable designed to be installed to the home, this product allows the installer to pull a bundle of cable without its own spool. Its primary advantage is that it's significantly smaller and lighter than other products on the market.

Cable can be removed from its original packaging and secured into place on the frame, keeping the cable organized when the product is payed-out. The adjustable arms can be moved by hand, and allow for loading/unloading of a spool and operating the frame without any tools.

An additional handle for cranking the unit (not shown) also makes it very convenient to spool cable, extension cords, rope or hoses back onto the frame for quick jobsite cleanup. The bundle can be left on the frame for storage or zip-tied and removed for convenient bundling.



Part No.	Bundle Inside Diameter	Bundle Outside Diameter	Bundle Width	Weight
50500-010	4" to 18-1/2"	26" maximum	5" maximum	8.3 lb

## Power Blower

The DCD Power Blower is unique, a portable unit with the maximum pressure available in this class of line blowers: up to 30% higher. While there are several other similar products on the market, the DCD unit offers an excellent list of special features, including:

- Acceptable for outdoor use (not in rain).
- Heavy duty industrial three-stage motor with sealed bearings and delivering up to 95 cfm and 5 psi.
- A heavy-duty 2" hose made of crush resistant polyethylene, 15' long, which will stand up in temperatures from -40°F to +140°F.
- The blowers operate at 110/120VAC and require 15 amp source. A 220V/110V voltage convertor and a plug adapter are also available.



Although other manufacturers have a higher cfm rating, that will only increase the speed of the dart. The higher pressure rating is key because this will allow a dart carrying pull tape or twine to travel further with higher loads, even though it might take a few seconds longer (see below for a full explanation).

DCD also offers a full line of blowing accessories detailed on the following pages, available as kits or individually to build your own toolbox. DCD Line Blowing products feature a range of innovations to suit your application and go farther.

Part No.	Description	Weight
58400-000	Power Blower 110V	20.8 lb
58400-110	Power Blower with 15' Hose (2" dia.) and Seal Offs for 1/2" to 6" duct	26.8 lb
58400-200	Power Blower (58400-000) with Voltage Converter (58400-201)	74.7 lb
58400-201	Voltage Converter to convert 220V power to 110V	58.0 lb
58400-220	Power Blower (58400-000) with Voltage Converter (58400-201), 15' Hose (2" dia.), and Seal Offs for 1/2" to 6" Duct	94.8 lb
58410-025	25' Optional Hose (2" dia.)	10.5 lb

## Understanding Blower Performance

The output of a blower is usually specified in terms of its flow rate (cfm) and its pressure (psi). The flow rate determines how fast the blower can move a projectile, and the pressure determines how much load the projectile can pull and how far it can pull it.

When a blower is running with an unrestricted outlet, it will produce its maximum specified flow rate because there is no resistance against it.

If the blower is attached to a length of empty conduit, the blower has to move all the air in the conduit to push any through. Friction against the conduit wall will resist that movement. As the blower works against this backpressure, its flow rate drops.

Therefore a blower can never produce its maximum advertised flow rate in a practical application due to air friction in the duct.

As the length of conduit increases, friction increases, backpressure increases, and flow rate decreases. At some point, the backpressure will increase to a point at which it equals the maximum pressure that the blower can generate, and the flow rate will be zero.

When a projectile is inserted, it blocks the conduit. As more air is pushed in behind the projectile, the backpressure rises until it exceeds the projectile's drag and it begins to move along the conduit. Therefore the drag creates the backpressure, which, in turn, determines the blower flow rate and ultimately the speed of the projectile.

As the projectile moves down the conduit, the drag force increases because of the weight and friction of the line being pulled is increasing. At some distance, the increasing backpressure equals the maximum pressure that the blower can develop, and the projectile will stall.

Because only blowing pressure can overcome backpressure, a blower with higher blowing pressure capability will ultimately go farther. The DCD Power Blower is designed around a high-pressure motor to go farther. More pressure, more distance.

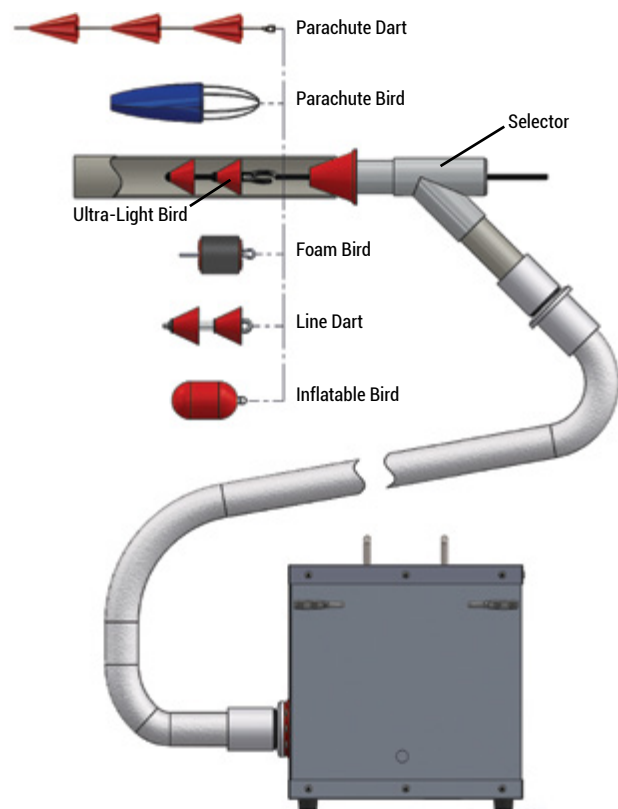

## Hose Assembly

The Hose Assembly is made from crush-proof 2" hose and is 15' or 25' in length. At the end where the Seal Off Body attaches, there is a swivel connector allowing the body to be turned in any direction.



Part No.	Description	Weight
58410-015	Hose Assembly - 2" dia. x 15' L	7.10 lb
58410-025	Hose Assembly - 2" dia. x 25' L	10.50 lb
58410-100	Carrying Bag for Hose	1.93 lb

## Seal Offs

The three Seal Off sizes are designed to cover all duct sizes from 1/2" to 6". Each of the units will attach directly onto the Seal Off Body which, in turn, attaches onto the Hose Assembly.



Part No.	Description	Weight
58420-010*	Seal Off Adapter - 1/2" to 1-1/2"	0.36 lb
58420-020*	Seal Off Adapter - 1-1/2" to 3"	0.72 lb
58420-030*	Seal Off Adapter - 2-1/2" to 6"	2.01 lb
58420-040*	Seal Off Body	1.46 lb
58420-000	Kit - Includes above parts marked *	4.55 lb

## Line Darts

DCD Line Darts are unique for several reasons. The colour coded cones match the Seal Kits (58200 series). The edges of the cones are tapered to allow better flexing when required to go around bends etc. The thin edges will also flare out to give better sealing and faster blowing once under pressure. Spare cones are available and replacement is simple.



Part No.	Nominal Duct Size	Length	Weight	Spare Cones
58300-100	1"	2-5/8"	0.04 lb	58350-100
58300-125	1-1/4"	3-1/16"	0.06 lb	58350-125
58300-150	1-1/2"	3-1/2"	0.07 lb	58350-150
58300-200*	2"	5"	0.17 lb	58350-200
58300-250*	2-1/2"	5-1/4"	0.18 lb	58350-250
58300-300*	3"	5-5/8"	0.27 lb	58350-300
58300-400*	4"	7-1/8"	0.39 lb	58350-400
58300-500	5"	8-3/8"	0.75 lb	58350-500
58300-600*	6"	9-1/4"	0.94 lb	58350-600
58300-800	8"	10-31/32"	1.76 lb	58350-800
58300-1100	11"	14-21/32"	4.04 lb	58350-1100
58300-KT1	Kit - Includes above parts marked *	-	6.00 lb	-

## Parachute Darts

Also known in the industry as a Triple Shuttle, this device is intended to be blown through a duct with compressed air and pull tape or rope which is attached to the rear eye of the dart. Similar to the line darts and ultralight birds, the fabric is flexible, allowing it to flex when going around bends. It consists of three synthetic fabric parachutes attached to our tried and tested flexible fiberglass rod. The use of three parachutes provides the best reliability in catching air and pulling the tape down the conduit.



Part No.	Nominal Duct Size	Length	Parachute Size	Weight
58340-200	1" to 2"	19-1/2"	1-1/8"	0.09 lb
58340-400	2-1/2" to 4"	29-1/2"	2-1/4"	0.13 lb
58340-600	4-1/4" to 6"	37-1/2"	4-1/4"	0.15 lb
58340-800	6-1/4" to 8"	37-1/2"	5-1/4"	0.17 lb
58340-1200	10-1/4" to 12"	37-1/2"	6-5/8"	0.20 lb



## Foam Birds

DCD Foam Birds are one of the more common ways to carry pull tapes through empty ducting. The product can also be used to spread lubricant through the duct before pulling cable. Sizes are standard and will fit duct sizes 2" through 6".



Part No.	Nominal Duct Size	Weight
58230-125	1-1/4"	0.06 lb
58230-200*	2"	0.06 lb
58230-250*	2-1/2"	0.06 lb
58230-300*	3"	0.09 lb
58230-350	3-1/2"	0.12 lb
58230-400*	4"	0.14 lb
58230-500	5"	0.27 lb
58230-600*	6"	0.39 lb
58230-KT1	Kit - Includes above parts marked *	0.74 lb

## Ultra Light Birds

Unique to DCD, these birds are made out of polyurethane and, as the name implies, are about half the weight of the regular Line Darts. The cones are very tough yet extremely thin – so thin, in fact, that they can be easily inverted in the event that the dart gets stuck and it is necessary to pull them back out.



Part No.	Nominal Duct Size	Weight
58320-200*	2"	0.04 lb
58320-250*	2-1/2"	0.04 lb
58320-300*	3"	0.08 lb
58320-350	3-1/2"	0.11 lb
58320-400*	4"	0.14 lb
58320-500	5"	0.19 lb
58320-600*	6"	0.34 lb
58320-KT1	Kit - Includes above parts marked *	1.02 lb

## Inflatable Birds

Although many companies offer this Inflatable style of bird, DCD's version is made of coated nylon and stitched for greater strength. The purpose of the Inflatable is to be able to blow through ducting already containing cable.



Part No.	Nominal Duct Size	Weight
58330-075	3/4" to 1-1/4"	0.01 lb
58330-150	1-1/2" to 2-1/2"	0.03 lb
58330-300	3" to 4"	0.06 lb
58330-500	5" to 6"	0.07 lb
58330-KT1	Kit - Includes all above parts	0.62 lb

## Parachute Birds

With a large open mouth, these Parachutes are able to grab all the air blown into the duct and will travel faster and farther than any other model. They are made out of coated nylon and can be used in occupied duct.



Part No.	Nominal Duct Size	Color Code	Weight
58335-100	1" to 2"	Red	0.04 lb
58335-200	2" to 3"	Blue	0.15 lb
58335-300	3" to 4"	Brown	0.12 lb
58335-400	4" to 6"	Green	0.15 lb
58335-KT1	Kit - Includes all above parts		0.89 lb

## Control Valve

The Control Valve is an integral part of the DCD blowing system. A ball valve allows control of air flow and quick disconnect fittings are attached at both ends. Three Rope Guides are included with each Control Valve purchased.



Part No.	Description	Weight
58000-000	Control Valve with Rope Guides	2.47 lb
58000-188	Rope Guide - 3/16"	0.10 lb
58000-250	Rope Guide - 1/4"	0.07 lb
58000-375	Rope Guide - 3/8"	0.04 lb

## Control Valve Adapter

The Control Valve Adapter allows connection of the Control Valve to the Seal Off Adapters (58420 series).



Part No.	Description	Weight
58000-100	Control Valve Adapter	4.0 lb

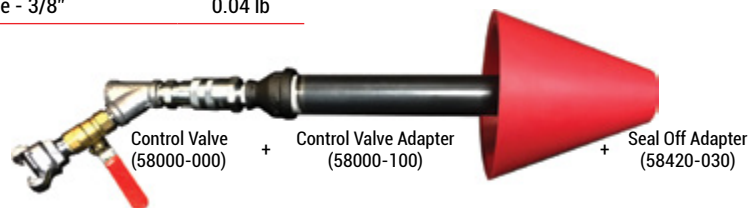

## Innerduct Seals

DCD offers two types of seals. The Innerduct Seal is a screw-in type that requires one product for each duct size. The second type is a Universal Seal which is a tapered product suitable for all duct sizes from 1" to 2". This is for use on short distance blowing where simply holding the seal against the end of the duct will do the job and save time.

The Kit comprises all four Innerduct Seals plus the Universal Seal. A Control Valve and Rope Guides are also included.



Part No.	Description	Nominal Duct Size	Weight
58100-000	Universal Seal	1" to 2"	1.50 lb
58100-100	Innerduct Seal	1"	1.40 lb
58100-125	Innerduct Seal	1-1/4"	2.20 lb
58100-150	Innerduct Seal	1-1/2"	3.02 lb
58100-200	Innerduct Seal	2"	3.96 lb
58150-000	Universal Kit with Control Valve, 4 Innerduct Seals, and 1 Universal Seal	1" to 2"	18.0 lb

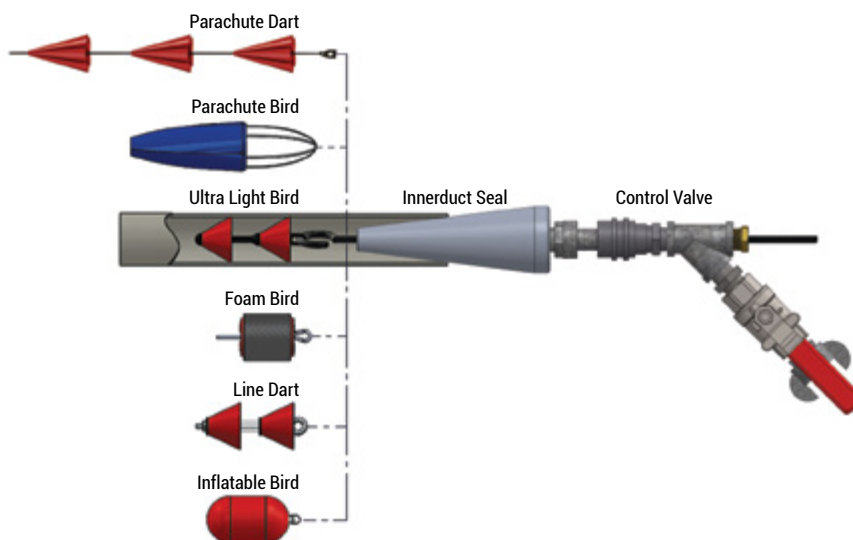

## Duct Seals

Duct Seals are unique for several reasons. The expandable seals are colour coded for easy recognition. They are made from a specially formulated polyurethane designed to give maximum sealing and expansion properties.

While a single seal is difficult to align properly, a double seal is expensive.

The DCD unit has a single seal, but supports it with an alignment washer. Economical but effective. All seal sizes fit over the same Handle Assembly and changing the size of seal used is a breeze. Just unscrew two nuts, slide off one Seal Kit and slide on the next one.

The end of the unit is fitted with a quick release coupling. Each Seal Kit comes complete with the polyurethane seal, two compression washers and one stabilizing washer. Just order the size of seal you need plus one Handle Assembly. Next time, just order the new size of seal you need.

Note: All seals have been tested to at least 15% higher than stated values. The actual pressure attained may depend on the condition of both the duct and the Seal Kit. Care should be taken at all times when working with pressurized systems.

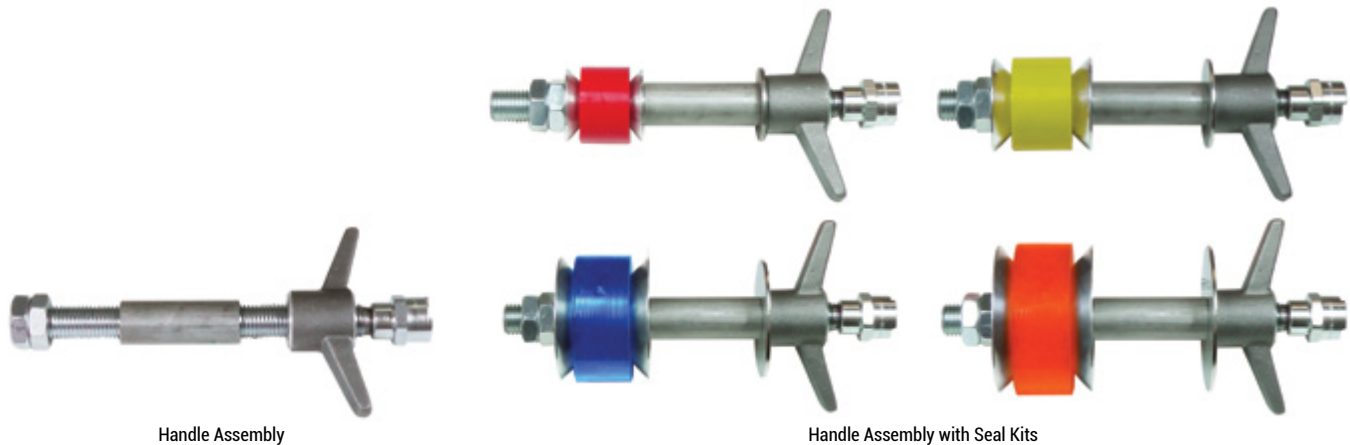

Part No.	Description	Nominal Duct Size	Minimum Duct Inside Diameter	Maximum Duct Inside Diameter	Color Code	Maximum Tested Pressure	Weight
58200-000	Handle Assembly	-	-	-	-	-	3.00 lb
58200-200	Duct Seal Kit	2"	1-13/16"	2-5/16"	Green	40 psi	0.23 lb
58200-250	Duct Seal Kit	2-1/2"	2-3/16"	2-3/4"	Red	35 psi	0.45 lb
58200-300	Duct Seal Kit	3"	2-13/16"	3-3/8"	Yellow	30 psi	0.93 lb
58200-350	Duct Seal Kit	3-1/2"	3-1/4"	3-13/16"	White	25 psi	1.23 lb
58200-400	Duct Seal Kit	4"	3-5/8"	4-1/4"	Blue	20 psi	1.59 lb
58200-500	Duct Seal Kit	5"	4-1/2"	5-1/8"	Orange	15 psi	2.67 lb
58200-600	Duct Seal Kit	6"	5-3/8"	6-1/16"	Black	10 psi	3.81 lb
58200-800	Duct Seal Kit	8"	7-5/8"	8"	Red	10 psi	9.40 lb

Note: Handle Assembly and one Duct Seal Kit are required to properly use this product.

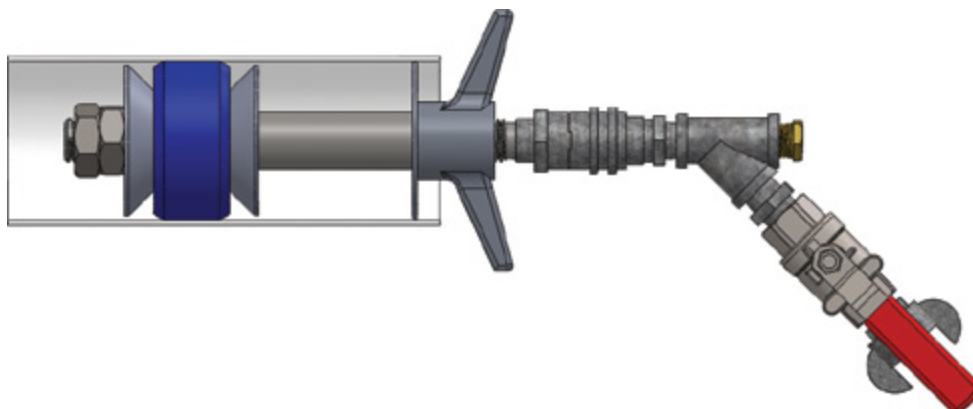

## Spool Frame with Support Cones

The DCD Spool Frame is engineered for years of trouble free usage. While DCD offers this product for carrying our Pull Tapes, it can also be used for carrying data and communication cable drums. It has an easy fold up frame that is convenient for carrying or storage and does not require removing the spool or the 1/2" dia. spool support bar.

After a customer request, we designed the support cones, which prevents the spool from rocking during use and provides increased stability for the unit.



58540-015



58540-020

Part No.	Description	3:1 Safe Working Load	Capacity	Weight
58540-010	Spool Frame with Bar	100 lb	16-1/2" W x 20" dia.	7.85 lb
58540-020	Spool Frame with Bar and Cones	100 lb	16-1/2" W x 20" dia.	8.25 lb
58540-015	Replacement Cones	-	-	0.40 lb

## Tapes and Twine

DCD partnered with Arnco in handling a wide range of high performance Bull-Line™ Pull Tape products to expedite cable installation. Choose from woven polyester tape products which are available in a variety of strength and lengths. A single pull tape eliminates the additional labor required for string, rope or winch line combinations.

All Bull-Line™ tape is manufactured with the Stiff-Tape™ lubricated coating, resulting in the highest performance pull table available in the industry.

Whatever the choice, Bull-Line™ Pull Tapes have continually provided a superior alternative to plastic pull ropes in cable installations through all types of conduit. Bull-Line™ Pull Tapes meet or exceed all pull line requirements of Bellcore GR-356-CORE.

Polyester Bull-Line™ is the most economical pull tape, very strong and durable and the elongation at yield is about 12% to 15%. Detectable tape have a 22 gauge solid copper wire woven into the tape.

Note: Can be pulled with our Fiber Cable Puller (42700 series).



Part No.	Description	Tensile Strength	Weight
58500-530	Pull Tape Pre-Lubricated - 1/2" x 3,000'	1,250 lb	24.5 lb
58500-630	Pull Tape Pre-Lubricated - 5/8" x 3,000'	1,800 lb	32.5 lb
58500-665	Pull Tape Pre-Lubricated - 5/8" x 6,560' (2,000 m)	1,800 lb	78.0 lb
58500-730	Pull Tape Pre-Lubricated - 7/8" x 3,000'	2,500 lb	48.5 lb
58500-765*	Pull Tape Pre-Lubricated - 7/8" x 6,560' (2,000 m)	2,500 lb	109.0 lb
58510-550	Detectable Pull Tape - 1/2" x 5,000'	1,250 lb	54.5 lb
58510-650	Detectable Pull Tape - 5/8" x 5,000'	1,800 lb	70.5 lb
58520-001	Measuring Tape - 3/16" x 3,000'	160 lb	3.7 lb
58530-001	Blowing Twine with Pail and Lid - 7,000'	180 lb	12.0 lb
58530-002	Blowing Twine with Pail and Lid - 3,000'	400 lb	12.5 lb

\* Wood reel standard.

Note: Other sizes available upon request. Wood reels available in pallet quantities only.



## Overhead Products Introduction

In 2006, DCD Design took on the Cable Spinning Equipment Company and began producing the Lineman™ and Eagle cable lashers. In doing so, DCD took on a long history of quality and innovation.

These lashers were previously manufactured by Cable Spinning Equipment Company, Inc. in New London, MN and before that, in Topeka, KS. The original company was founded in the late 1930's by Mr. Dory Neale.

Their history in lashers goes back to their early patents in 1942 when Mr. Neale had the first ever patent on a cable spinner. That was for the one-man spinner shown in the photograph to the right. From those days onward, there have been several other patents and many innovative improvements.



## Model Q Lasher

The Model Q hand-type Lasher is made for short span jobs like splicing or repair, traffic light installation, control cables, aerial inserts for underground construction or any job that would be simpler with a hand-held, variable tension lasher.

The Q Lasher adjusts easily according to how you wrap the wire around the tension rollers and is compatible with either .045" or .061" S-type lashing wire.

The rugged body is of cast aluminum with a removable flange for easy loading. Wire tension rollers are of hardened tool steel.



Part No.	Maximum Strand	Maximum Lash	Wire Size	Spool Size	Overall Dimensions	Weight
61100-000	1/2"	1-15/16" dia.	0.045" to 0.061"	225' or 375' per coil	9-1/2" L x 5" W x 3" H	2.0 lb

## Falcon Lasher

The Falcon Lasher is a completely redesigned lasher, incorporating design elements of our previous Eagle, Lineman and Model K lashers, as well as new design concepts that simplify the lasher to make it more robust and lower maintenance.

This new lasher will single or double lash without strand traction. It is also equipped with a clutch handle to allow easy mounting and passing the unit around a pole without cutting the lashing wire or removing it from the drive wheels.

The capacity has been expanded beyond the Lineman™ Lasher and the use of innovative, modern engineering materials makes it lightweight and practical for smaller jobs previously done by the Eagle Lasher.

Weighing in at 20 lb, the Falcon Lasher is lighter than even smaller capacity lashers on the market. Compared to lashers of similar capacity, it weighs less than half the weight of typical lashers.

Magazine style doors provide easy loading of metallic or non-metallic lashing wire. Front and rear rollers made from Delrin allow smooth passage of cable and also protect your cable from damage. A simplified rear gate design with quick release mechanisms allows for efficient adjustment of the rear roller.

We are so confident in our new design that we are extending the DCD Limited Warranty Policy from 6 months to 12 months for this product.

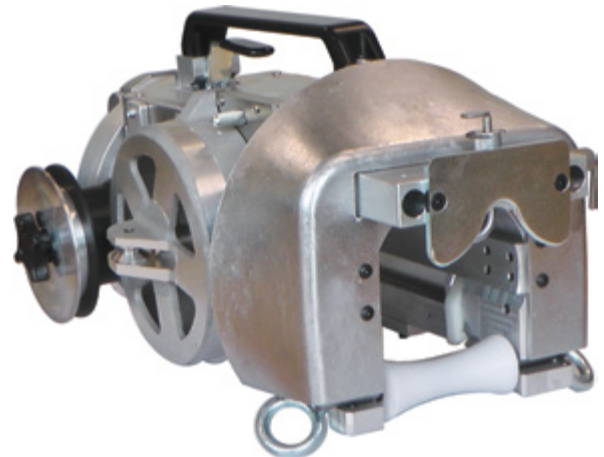

Part No.	Maximum Strand	Maximum Lash	Wire Size	Spool Size	Overall Dimensions	Weight
61800-000	1/2"	3-1/2" dia.	0.038" to 0.061"	1,200' per coil	20" L x 11" W x 10" H	21.3 lb

## Eagle Lasher

The Eagle Lasher was designed and built to meet the requirements of modern cable lashing jobs. Sized to install CATV or fiber optic cables, it's lightweight, durable and simple. Since its introduction, the design has proven itself on the strand, from the Arctic Circle to Asia Minor.

With a bundle capacity of 2-1/4" or single cable up to 2", the Eagle lasher will single- or double-lash most Last Mile or FTTH installations. Careful material selection and precise CNC machining have trimmed the weight of the machine to just 25 lb. – significantly less than other lashers of this size range. The Eagle lasher also now uses a wire quick release trigger, mounted below the handle, for easy, one-hand engagement and release for continuous lashing and quick transfer time around poles.

Like all the DCD lashers, the Eagle does not need traction from the strand; it uses the tension from the lashing wire to drive rotation. This lasher uses industry standard straight-hub wire spools that are loaded into a pair of drop down magazine for added convenience. The lasher will also work with standard stainless lashing or non-metallic lashing wire.

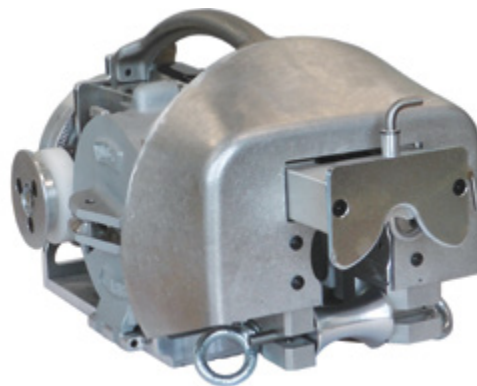

Part No.	Maximum Strand	Maximum Lash	Wire Size	Spool Size	Overall Dimensions	Weight
61700-000	3/8"	2-1/4" dia.	0.038" to 0.061"	1,200' per coil	18" L x 18" W x 8" H	24.0 lb

## Lineman™ Lasher

The Lineman™ Lasher is the pull type cable lasher for tough jobs, especially in dusty, wet or icy conditions. Use it to lash single or multiple cables up to 3" outside diameter and for single and double overlashing.

You won't get snagged in trees and tight places with the Lineman™ Lasher because of the smooth, tapered cowl. Transfer time around poles is cut by as much as one-third, with the wire quick release trigger mounts below the handle for easy, one-hand engagement and release for continuous lashing.

Versatility means less downtime and smooth operation. A key feature is that the Lineman™ requires no strand traction to drive rotation – this means you can now lash in any weather. The tough, precision drive system needs no adjustment and delivers even lashing action. The strand brake keeps wire tight prevents the lasher from sliding backward when forward motion is halted.

The Lineman™ Lasher holds up to 1200' per coil of 0.045" lashing wire without reloading, and works compatibly with up to 1/2" strands. A flat base ensures the lasher won't roll around in transit, and the ergonomic handle and controls add to total precision performance.



Part No.	Maximum Strand	Maximum Lash	Wire Size	Spool Size	Overall Dimensions	Weight
61400-000	1/2"	3" dia.	0.038" to 0.061"	1,200' per coil	19-1/2" L x 12" W x 12" H	38.0 lb

## Lasher Accessory - Tow Rope

Both the Eagle Lasher and Lineman™ Lasher come standard with a tow rope. However, a replacement can be ordered if required.



Part No.	Description	Overall Length	Weight
61439-000	Tow Rope (3/8" Rope x 7/16" Hook)	60"	1.0 lb

## Lasher Accessory - Halo Brush Guard

Halo Brush Guards are designed to sit at the leading edge of your Lineman™ or Eagle Lasher, so that branches and other obstacles are pushed out of the way during lashing and are less likely to be caught up in the entrance of the machine.

The guards are available in upper and lower models.



61442-000 & 61773-000



61436-000

Part No.	Description	Overall Dimensions	Weight
61442-000	Halo Ring Guard Kit - Lineman™	2" L x 13-3/4" W x 9-1/4" H	5.6 lb
61773-000	Halo Ring Guard Kit - Eagle	2" L x 13-3/4" W x 9-1/4" H	5.6 lb
61873-000	Halo Ring Guard Kit - Falcon	2" L x 13-3/4" W x 9-1/4" H	5.6 lb
61436-000	Halo Brush Guard	2-1/2" L x 9-3/4" W x 4-7/16" H	1.6 lb

## Overlash Assembly - Lineman™ & Falcon

When overlashing, the strand is already lashed to the cable and is no longer accessible for latching on with the strand lock. The overlash assembly will compensate by adjusting down to the already lashed bundle to provide stability and guide the machine. It mounts to the front of your Lineman™ or Falcon Lasher and can be adjusted down to the existing cable, accommodating a bundle as large as 3" dia.



Part No.	Overall Dimensions	Weight
61438-000	2-3/4" L x 4-7/16" W x 6-5/16" H	3.3 lb

## Rear Gate Kit - Lineman™

The Rear Gate guides and supports the cable exiting the lasher up towards the strand to aid in the lashing process. If the rear gate is damaged, a replacement is available.



Part No.	Overall Dimensions	Weight
61400-SK01	2-7/16" L x 5-1/2" W x 5-1/4" H	1.5 lb

## Wire Spool Plastic Guard Flange - Lineman™

The wire spool plastic guard is intended for use with the Lineman Lasher (61400-000) and can be inserted over top of the lashing wire spool and under the lashing wire flange. This allows the flange to be tightened even more securely and provides good grip on tough-to-use lashing wires, preventing twisting or bunching of the lashing wire while the spool is in the machine.



Part No.	Outside Diameter	Inside Diameter	Material	Weight
61409-065	6"	1-3/4"	Flexible High-Hardness Plastic Resin	0.06 lb

## Lashing Wire

The difference between DCD Lashing Wire and other lashing wires isn't visible to the eye. While all lashing wires may look and feel alike, DCD lashing wire is specially annealed for extra durability where the lash meets the strand. Wound in continuous coils for easy payout, DCD lashing wires won't come back to haunt you. Instead, the lash holds tight and stays even. DCD gives you multiple choices of size and type: aluminum, galvanized, various grades of stainless and non-metallic. All come in popular sizes to match any job, and while our sizes and types vary, our quality doesn't.



### Straight Hub

Industry standard coils (5-1/2") to fit DCD's three main Lashers, as well as other lashers with drop-down doors.



### Tapered Hub

Standard outside diameter to fit a tapered Cable Spinning Equipment hub (D Lashers).



### Disposable Metal Reels

Pre-coiled on 6" aluminum reels to fit Legacy K & Special K lashers with a 1-1/4" mounting post.



### Q-Sized

Compact coils (4" diameter) to fit the DCD Model Q Lasher. Available in three sizes.



### Non-Metallic Material

A lasher tension adjustment mechanism is necessary to compensate for the softer aramid strand.

Part No.	Wire Type	Lineman	Eagle	Falcon	Model K	Special K	Model S	Model Q	Straight-Hub	Modified DD	Model	Wire Diameter	Material	Coils per Box	Length	Net Box Weight	Total Coil Weight
61010-020	Straight Hub				✓	✓	✓				10A-3A	0.061"	316 Stainless	6	650'	42.0 lb	7.00 lb
61010-050		✓	✓	✓	✓	✓	✓				13A-3A	0.045"	430 Stainless	6	1,200'	41.0 lb	6.56 lb
61000-050	Tapered Hub				✓	✓					13A-1A	0.045"	430 Stainless	6	1,200'	41.0 lb	6.56 lb
61020-030	Disposable Metal Reels				✓	✓					11AK-1AK	0.061"	430 Stainless	5	750'	42.0 lb	8.19 lb
61020-050					✓	✓					13AK-1AK	0.045"	430 Stainless	5	1,200'	43.0 lb	8.31 lb
61020-060					✓	✓					23ANM-1AK	-	Non-Metallic	5	1,200'	11.0 lb	1.87 lb
61030-010	Q-Sized							✓			10AS-1AS	0.061"	316 Stainless	8	225'	20.0 lb	2.30 lb
61030-020								✓			11AS-1AS	0.061"	430 Stainless	8	225'	20.0 lb	2.26 lb
61030-030								✓			13AS-1AS	0.045"	430 Stainless	12	375'	18.0 lb	2.05 lb
61040-009	Non-Metallic								✓	✓	-	0.050"	Non-Metallic	6	900'	8.5 lb	0.91 lb

## Lashing Wire Clamps

DCD Lashing Wire Clamps are available in a range of sizes to suit your strand diameter. Two-piece clamps offer independent jaws; one-piece clamps form the jaws from a single metal plate. Metallic clamps (shown) are furnished with a double ended stud bolt and washers and free running nuts, all galvanized. Non-metallic type clamps are also available, but be sure to specify strand diameter.



Part No.	Model	Strand Size	Type	Clamps Per Box	Weight
61090-001	D-901	0.250" to 0.437"	Two Piece	100	11.0 lb
61090-002	E-902	0.250" to 0.375"	One Piece	100	10.0 lb
61091-228	NM-LC5-1	0.228" to 0.256"	Non-Metallic	100	0.5 lb
61091-449	NM-LC5-6	0.449" to 0.511"	Non-Metallic	100	0.5 lb
61091-453	NM-LC5-7	0.453" to 0.546"	Non-Metallic	100	0.5 lb

## Pin Guard

The Pin Guard is for use in overhead electrical work in live environment scenarios to guard against accidental line contact. Our pin guards are made from high impact, UV-resistant plastic. The product is dielectric tested, full plastic construction, and the lug eye fits standard Hot Sticks (standard shotgun sticks).



Part No.	Guard Dimensions	Handle/Lug Dimensions	Weight
62600-000	14-3/4" x 15-5/8"	1-21/64" x 7/16" (Hole size: 0.600")	1.9 lb



00005	13-14	00662	28	32560	57	57100	78
00010	13-14	00664	28	32600	56, 60	57101	78
00015	13-14	00670	29	32620	56	57110	78
00020	13-14	00671	29	32650	57	57120	78
00025	13-14	00674	29	32655	57	57130	79
00027	13-14	00675	29	32700	58	57131	80
00030	13-14	00678	29	32800	52-53	57135	79
00035	9, 13-14	00679	29	32810	52	57140	79
00037	9, 13-14	00680	30	32830	52-53	57150	79
00040	9, 13-14	00681	30	32900	55	57160	79
00045	9, 13-14	00682	31	32950	54	57170	80-81
00050	13-14	00690	31	35000	59, 61	57180	80
00101	9, 40-41	00695	30	35100	60	57181	80
00501	27	00696	32	35300	61	57500	81
00503	4-5	00697	32	40000	70-71	58000	85
00504	6, 9	00698	32	40010	71	58100	85
00505	14	00800	33	40030	72	58150	85
00506	14	00801	34	41000	62-63	58200	86
00508	7-12	00802	34	42000	68	58230	84
00510	61	00810	35	42100	64	58300	83
00515	61	00811	35	42110	64	58320	84
00520	15	00812	36	42120	64	58330	84
00521	15	00820	34	42130	64	58335	84
00522	15	00821	35	42200	66-68	58340	83
00530	17	00830	36	42300	65	58400	82
00531	16	00831	36	42310	65	58410	83
00535	17	00925	37, 40-41	42315	65	58420	83
00536	16	00926	37, 40-41	42320	65	58500	87
00537	23	08000	50	42330	65	58510	87
00540	23	08100	50	42400	68	58520	87
00550	17	08400	51	42410	69	58530	87
00551	16	08450	50	42420	69	58540	87
00555	17	08500	51	42430	69	60000	81
00560	18-22	23125	25	42500	69	61000	91
00565	19-21	23250	25	42600	70, 72	61010	91
00566	19-21	23375	25	42700	72	61020	91
00570	18-20	23500	25	50500	81	61030	91
00575	22	24000	38, 40-41	52000	74	61040	91
00600	45	24005	37-39	52100	74	61090	91
00604	44	24006	37-39	52200	74	61091	91
00605	44	24007	38	52300	74	61100	88
00615	45	24008	39	52400	74	61400	89-90
00616	46	24100	39-41	52500	75	61409	90
00617	46	24200	42	52600	75	61436	90
00620	47	24300	42	52700	75	61438	90
00621	47	24500	43	53500	75	61439	89
00622	47	25000	43	53600	75	61442	90
00625	46-47	32000	52	53700	75	61700	89
00626	46-47	32100	52	53800	75	61722	41
00630	47	32200	52-53	53900	75	61773	90
00631	47	32210	52-53	54000	76	61800	88
00650	48	32220	52	54100	76	61873	90
00651	48	32300	53	54200	76	62600	91
00652	24	32400	53	56000	76	90000	43
00653	24	32450	54	56100	76	90024	42
00654	24	32460	56	56200	76	90027	49
00655	24	32500	54, 60	56300	76-77	90030	12
00656	24	32501	54	56500	77	93100	40-41
00660	25	32510	57	56600	77	93106	40-41
00661	28	32550	57, 60	57000	77	C2012	46

## Shipments to U.S.A.

- All pricing is FOB Blaine, WA.
- There are no duties added to the prices shown. Taxes will be applied where applicable.
- Standard DCD shipping policy is that freight will be prepaid and added to the invoice unless otherwise stated on the customer order.
- Contact Customer Service for info about our "free freight" policy.

## Minimum Order

A handling fee of \$25.00 may be added to all orders under \$100.00 net value.

## Shipments to Canada

- All pricing is FOB Richmond, BC. Taxes will be added as per your jurisdiction.
- Freight will be prepaid and added to the invoice unless otherwise stated on the customer order.

## Loss or Damage

The carrier is responsible for any loss or damage that occurs during transit. Any claim should be filed with the delivery transport company.

## International Shipments

- All pricing is FOB Richmond, BC.
- Applicable duties and/or taxes may be added to the prices shown.
- Freight will be prepaid and added to the invoice unless otherwise stated on the customer order.

## Prices

Prices subject to change without notice. All orders subject to acceptance at the factory. We reserve the right to invoice prices in effect at time of shipment.

## Returned Material Information

- Product returns will only be authorized within 6 months of invoiced date.
- All returned product must have a Returned Material Authorization (RMA) number assigned by the factory. For all returns, please fill out the RMA form on our website ([www.dcdesign.com/rma-form.php](http://www.dcdesign.com/rma-form.php)).
- All product returns must have freight prepaid. No collect shipments will be accepted.
- All returned product is subject to a minimum 25% re-stocking charge. Only product in an "as new" condition will be accepted. If product is damaged or not in original packaging, a higher re-stocking charge may be assessed.
- Credit will be issued for product returned again replacement or future orders only - under no circumstances will DCD offer cash refunds.
- For product being returned for service or repair, after receiving the product DCD will submit a quotation for the repair work. This must be authorized by the customer prior to the work being commenced.
- Due to the need for excessive testing, Breakaway Pins will not be accepted as returns, unless for warranty claims.

## Limited Warranty

DCD Design & Manufacturing Ltd. extends the following warranty to the original purchaser of these goods for use, subject to the qualifications indicated: DCD Design & Manufacturing Ltd. warrants to the above party for use that the goods or any component thereof manufactured by DCD Design, will be free from defects in workmanship for a period of 3 to 12 months (depending on the type of product) from the date of purchase, provided such goods are installed, maintained, and used in accordance with DCD Design & Manufacturing's written instructions. See website for more details about the different warranty periods.

The following is the LIMITED WARRANTY POLICY for DCD DESIGN & MANUFACTURING LTD. (DCD) as it pertains to all Products in this catalog shipped to any market place including USA, Europe or elsewhere unless otherwise specified on any given order.

1. DCD warrants only that all Products supplied by them will be free of defects in design, material or workmanship and will conform to DCD's published configurations and specifications therefore.
2. Upon receipt of written notice from the distributor or customer, within the 3 to 12 month period, of any such defect, DCD shall promptly repair or replace the defective product without charge to distributor or customer or, at the sole discretion of DCD, may refund the price paid by the distributor for such defective product, provided it is clearly shown that such defects were caused by poor design, workmanship or materials. It is understood that the environment in which these products are used may be extremely hazardous and damage or excessive wear to the product can be caused by any one of many known or unknown elements. This warranty will not be in effect if an unreasonable amount of damage or wear or careless use of the product is found to be the cause of the defect.
3. All other warranties, either express or implied, for this product including, but not limited to, any implied warranties of merchantability and fitness for a particular purpose, are hereby disclaimed. If this product is not free of defects as warranted in paragraph 1 above, your sole and exclusive remedy shall be repair, replacement, or refund as provided in paragraph 3 above. In no event shall DCD or any of its authorized distributors be liable to any distributor or customer or any third party for any damages in excess of the purchase price of the product. This limitation applies to damages of any kind including direct or indirect damages, lost profits, lost savings or other special, consequential or incidental damages whether for breach of contract, tort or otherwise or whether arising out of the use of or inability to use such product even if DCD or an authorized distributor has been advised of the possibility of such damages or of any claim by any other party. The foregoing limitation of liability applies to DCD and all authorized distributors and is required to be, and will be deemed to be, included in any warranty, express or implied, provided by such authorized distributors.

## WARNING

**IMPORTANT:** All DCD products are designed and manufactured in a manner to satisfy both the design requirements and claimed capacities. At no time should any product be modified, neither should any replacement parts not supplied and approved by DCD Design & Manufacturing Ltd. be used on DCD products. Such instances as using a standard Hexagon Bolt in place of a specially designed Clevis Pin can result in damage to the product and/or to property and may result in severe injury or death to operators or persons near by. In any such instances, the terms of this warranty will be voided and DCD will accept no responsibility for product failure or personal injury.

1-888-794-8357  
604-232-4445  
dcddesign.com



6620 McMillan Way  
Richmond, BC  
Canada V6W 1J7