

# Multispindle Heads

Boîtiers Multibroche / Teste Multiple



“Perfect work requires passion, precision  
and well designed and reliable tools.  
Madaula’s focus  
is to supply these tools to world-wide industry”



# Tradition in precision

Since 1956 **Madaula** has stood for the highest quality and the best reliability of its products. We have more than 60 years of experience in design, development and manufacture all kind of heads for the machine tool industry.



Depuis 1956, **Madaula** est synonyme de la plus haute qualité et de la meilleur fiabilité pour ses produits. Nous avons plus de 60 ans d'expérience dans la conception, le développement et la fabrication de tous types de têtes pour l'industrie de la machine-outil.

Dal 1956 **Madaula** è sinonimo di massima qualità e di grande affidabilità. Abbiamo più di 60 anni di esperienza nella progettazione, sviluppo e produzione di tutti i tipi di teste per il settore delle macchine utensili.



# Innovation and reliability

We're focused on our ability to create products adapted to our customer's needs, reduce their manufacturing cost, thereby improving their competitive edge in the market. We work to ensure optimally designed, precise, robust and durable products. We love challenges. Our goal is to turn your vision into reality and thereby increase your productivity.

Nous nous sommes consacrés sur notre capacité à créer des produits adaptés aux besoins des clients, à réduire leurs coûts de fabrication et ainsi améliorer leur avantage compétitive sur le marché. Nous travaillons pour créer des produits de conception optimale, durables, robustes et précis. Nous aimons les défis. Notre objectif est d'augmenter votre productivité.

Siamo concentrati sulla nostra capacità di creare prodotti adatti alle esigenze dei nostri clienti, ridurre i loro costi di produzione, migliorando in tal modo il loro vantaggio competitivo nel mercato. Lavoriamo costantemente per progettare in modo ottimale i nostri prodotti per renderli precisi, robusti e durevoli. Noi amiamo le sfide. Il nostro obiettivo è quello di trasformare la vostra richiesta in realtà e di conseguenza aumentare la vostra produttività.

# All over the world



Our head office and factory are located in Barcelona, recognized city throughout the world by the creativity and constant innovation of its industries. We sell all over the world with subsidiaries in Germany, USA, Italy, France, Brazil and India, with representatives all over the world. We export the 80% of our production.

Notre siège social et l'usine sont situés à Barcelone, ville reconnue mondialement par sa la créativité et constante innovation. Nous vendons partout dans le globe avec des filiales en Allemagne, USA, Italie, France, Brésil et l'Inde, et avec des représentations dans le monde entier. Nous exportons le 80% de notre production.

La nostra sede principale e lo stabilimento si trova a Barcellona, città riconosciuta in tutto il mondo per la creatività e l'innovazione costante delle sue industrie. Vendiamo in tutto il mondo con filiali in Germania, Stati Uniti, Italia, Francia, Brasile e India con i rappresentanti di tutto il mondo. Esportiamo l'80% della nostra produzione.

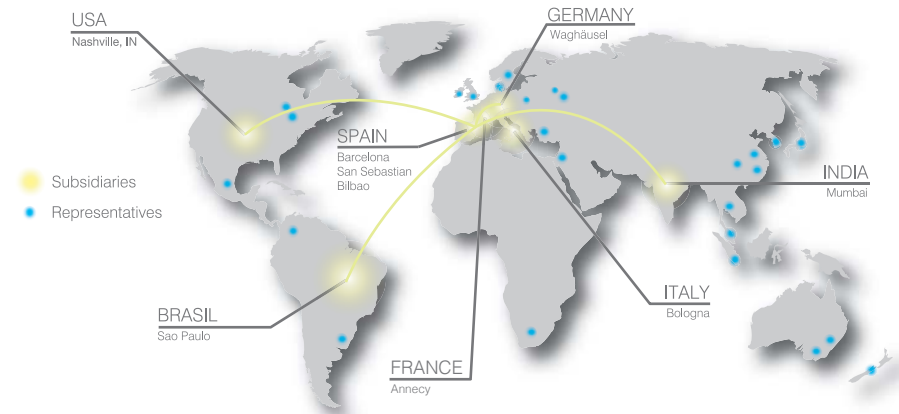

# Manufacturing facilities

We welcome you to our facilities. Madaula has a continuous improvement policy, we invest to improve our technical production, assembly and quality departments.

Soyez les bienvenus dans nos nouvelles installations. Madaula investit constamment afin d'accroître sa capacité de production. Nous avons développé nos départements usinage et montage mais aussi qualité.

Abbiamo il piacere di informarvi a riguardo i nostri nuovi servizi. Madaula investe per migliorare la propria capacità di produzione di utensili. Ampliamo i nostri reparti di assemblaggio e di qualità.



# Application fields

## Aerospace

Aéronautique / Aerospaziale

## Heavy industry

Industrie lourde / Industria pesante

## Orthopaedics

Orthopédie / Ortopedia

## Automotive

Automobile / Automotive

## Machine tool equipment

Équipement de machine-outils /  
Attrezzature per macchine utensili

## Power generation

Génération d'énergie / Produzione di energia

## Components

Composants mécaniques / Componenti

## Medical

Médical / Medicaale

## Railway engineering

Ferroviaire / Ingegneria ferroviaria

## Electronics

Électronique / Elettronica

## Micro-mechanics

Micro-mécanique / Micro-meccanica

## Watch-making industry

Industrie horlogère / Settore orologeria

## Energy

Énergie / Energia

## Defense

Défense / Difesa

## Wind industry

Industrie éolienne / Settore eolico

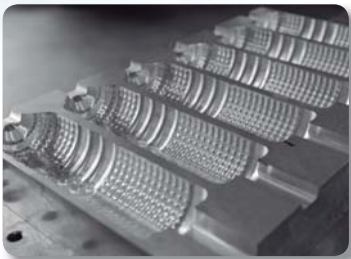

Turbine image by Kollected

# Passion for precision

Precise and rigid manufacture

Adaptable to all types of machines

100% Checked and tested

High speed rotation

Longer tool life

- 1** **Application: Drilling, tapping, reaming, milling & boring.**  
Application: perçage, taraudage, alésage, fraisage & perforation.  
Lavorazione: foratura, maschiatura, alesatura, fresatura & barenatura.
- 2** **All type of tapers and norms available: ISO, CAT, BT, DIN, HSK, CAPTO.**  
Tous types de cônes et des normes disponibles: ISO, CAT, BT, DIN, HSK, CAPTO.  
Tutti i tipi di coni standard disponibili: ISO, CAT, BT, DIN, HSK, CAPTO.
- 3** **Our standard heads as well as the special ones meet your machining requirements.**  
Aussi bien pour les modèles standards que pour la fabrication spéciale, nos boîtiers s'adaptent à vos besoins d'usinage.  
Sia per versione standard come speciale, le nostre teste si adattano alle sue necessità di fabbricazione.
- 4** **Multiple output options: from 2 up to 100 spindles, no matter the heads sizes.**  
Multiples options de sortie: depuis 2 sorties jusqu'à plus de 100, la taille des pièces n'est pas un problème.  
Diverse opzioni di uscita: da 2 uscite a più de 100, non importa il volume dei pezzi.
- 5** **A tailor-made project for each application will be made.**  
Nous étudierons personnellement chaque application.  
Si realizzerà un studio personalizzato de ogni applicazione.
- 6** **Different speeds for every spindle to suit all types of applications.**  
Vitesses différentes pour chaque sortie, permettant l'adaptation parfaite pour chaque application.  
Velocità differenziate per ogni uscita per un perfetto utilizzo specifico in base all'applicazione.
- 7** **All type of heads for each type of batch (small, medium-sized and large) is available.**  
Nous disposons d'un modèle de boîtier pour chaque type de série (petite, moyenne et grande).  
Disponiamo di un tipo di teste per ogni serie (piccola, mediana e grande).
- 8** **Also available with coolant through the spindle.**  
Disponibile avec passage du liquide de refroidissement à travers de la broche.  
Disponibili con refrigerante interno (mandrino).

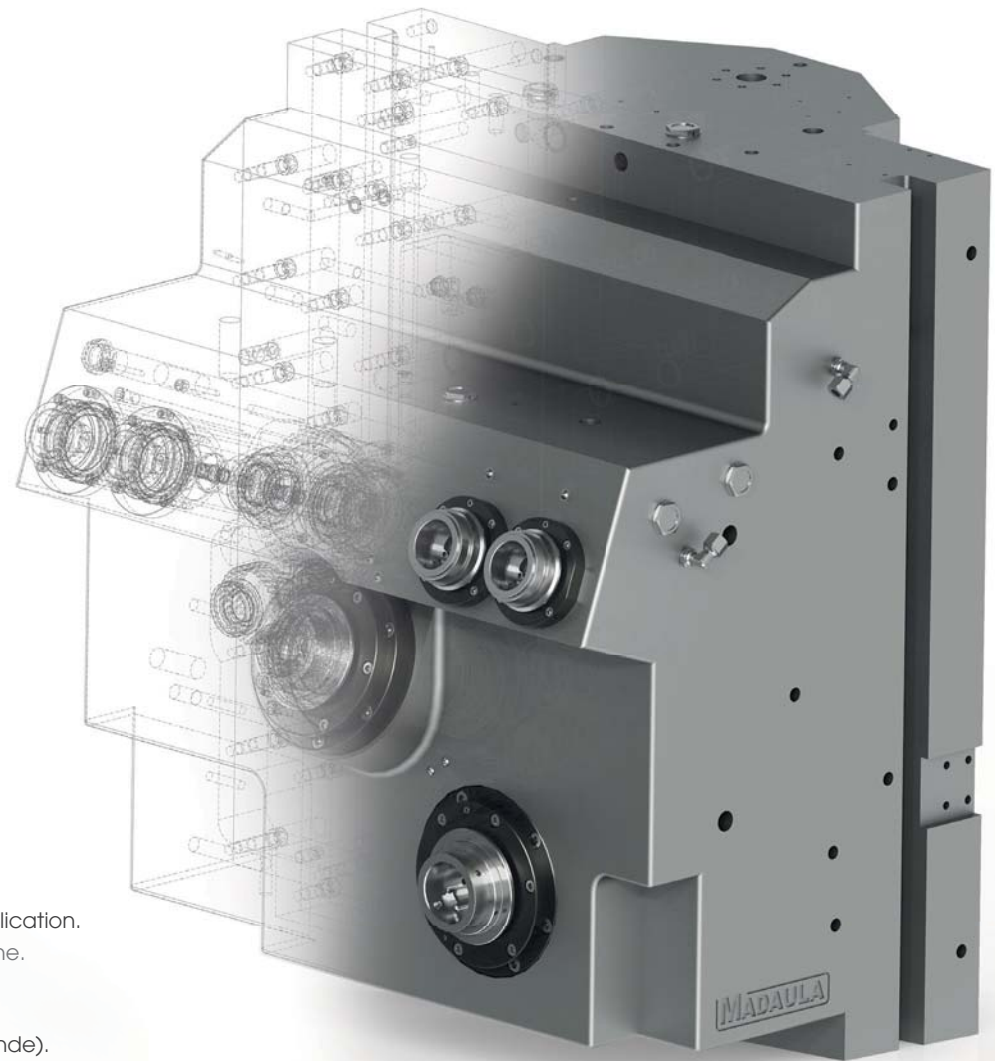

# STATIONARY









**2** Arbor Outputs Reducer

**3** Outputs Speeder 

**7** Outputs with Internal Coolant 

**Application**

HEAVY INDUSTRY - ENERGY - POWER GENERATION - DEFENSE

Attachment	Unit slide	Flanged	Flanged
	2x - Saw Cutters	3x - HSK-100	7x - HSK-50
<b>R.P.M Max</b>	535	1.800	5.000
	 5.6:1	1:3 	1:1.25 / 1:2.5 
	100	1.200	150
	Grease	Oil bath	Grease

# STATIONARY







**2** Outputs Recessing Head 

**6** Outputs fixed at 20° 

**14** Outputs drilling & milling Head

## Application

AUTOMOTIVE - ENERGY - POWER GENERATION - DEFENSE

Attachment	Table	to Machining unit	to Machining unit
	2x - Built-in grooving system	4x - HSK-63 / 2x - HSK-80	12x - HSK-63 / 2x - HSK-80
<b>R.P.M Max</b>	350	2.500	2.500
	2:1 	1:1	1:1
	800	2.000	2.500
	Recirculation Oil Mist	Recirculation Oil Mist	Recirculation Oil Mist



# EXCHANGEABLES



**4** Square outputs

**4** Outputs with internal coolant 

**6** Outputs with internal coolant 

**Application**

AEROSPACE - AUTOMOTIVE - COMPONENTS - MACHINE TOOL

**Attachment**

Any type of taper

	4x - ER-16M	4x - ER-16	6x - ER-25
<b>R.P.M Max</b>	3.000	3.000	2.000
	1:1	1:1	 2:1
	6.5	8	12
	Grease	Grease	Grease

# LIVE TOOLING



**2** Outputs Offset Axial

**4** Square Outputs Radial

**5** Outputs Axial

**Application**

AEROSPACE - AUTOMOTIVE - COMPONENTS - MACHINE TOOL

Attachment	VDI-40	VDI-25	VDI-50 DIN-4580
	2x - ER-32	4x - WELDON Ø20	5x - ER-32
<b>R.P.M Max</b>	4.000	6.000	4.500
	1:1	1:2	1:1.5
	12	8	20
	Grease	Grease	Grease



# LIVE TOOLING







**2** Different Outputs Radial

**2** Outputs Offset Axial

**4** Square Outputs Radial

## Application

AEROSPACE - AUTOMOTIVE - COMPONENTS - MACHINE TOOL

Attachment	BMT-45	BMT-65	BMT-85
	2x - ER-25 / ER-16	2x - ER-25	4x - ER-25
<b>R.P.M Max</b>	5.000	6.000	6.000
	1:1	1:1	1:1
	6	8	15
	Grease	Grease	Grease

# OTHER UNITS



**4** Line Outputs Speeder

**4** Square Outputs

**2** Outputs fixed at double angle

**Application** AEROSPACE - AUTOMOTIVE - COMPONENTS - MACHINE TOOL - TRANSFER MACHINES

<b>Attachment</b>	Flanged	Flanged	Flanged
	4x - ER8-M	4x - Cyl.Ø20	2x - HSK-40
<b>R.P.M Max</b>	3.000	4.000	6.000
	1:2 	1:1	1:1
	3.5	25	20
	Grease	Grease	Air-oil

# CMX Adjustable Multispindle Heads

CMX-/2

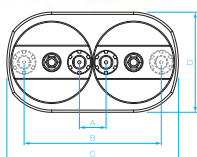

CMX-/L3

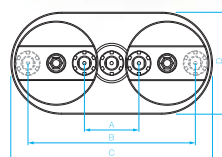

CMX-/3

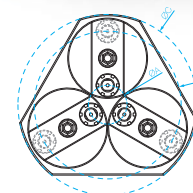

CMX-/4

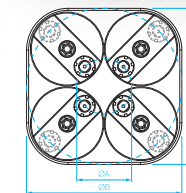

CMX	A mm	B mm	C mm	D mm		Cast mm	Steel mm			R.P.M Max	
12/2	12	72	92	52	ER-8	4	5	M3	1:1	4.000	0.9
12/L3	24	84	104	52							1.2
12/3	Ø18.5	Ø78.5	Ø100	-							1.4
12/4	Ø29.5	Ø89.5	Ø111	-							2.0
18/2	18	98	122	75	ER-11	6	7	M5	1:1	3.500	2.1
18/L3	36	116	140	75							3.2
18/3	Ø27	Ø107	Ø130	-							3.6
18/4	Ø42	Ø122	Ø148	-							4.5
24/2	24	124	155	90	ER-16	8	10	M6	1:1	3.500	4.5
24/L3	48.5	148.5	180	90							5.1
24/3	Ø35.5	Ø135.5	Ø166	-							6.3
24/4	Ø55	Ø155	Ø185	-							7.5
33/2	33	160	203	106	ER-20	13	14	M12	1:1	3.000	6.3
33/L3	66	193	236	106							8.4
33/3	Ø48	Ø175	Ø217	-							9.5
33/4	Ø73	Ø200	Ø242	-							13.9

# Everything is possible

Customized products for Innovative solutions: We match the tool to the part and to the machine.

Our team of engineers and technicians are working together to create new products to enhance the machine capabilities and increase the productivity of our customers.

## 60 years of experience

in the development of special products.

60 ans d'expérience dans le développement de produits spéciaux.

60 anni di esperienza nello sviluppo di prodotti speciali.

## Successful technical experience

and market knowledge.

Réussi savoir-faire technique et connaissance du marché.

Esperienza tecnica e successo di mercato

## Engineers and technicians

working to together.

Ingénieurs et techniciens qui travaillent ensemble.

Ingenieri e tecnici che lavorano assieme.

## Ingenuity and open mind

to find the best solutions.

Ingéniosité et l'esprit ouvert pour trouver les meilleures solutions.

L'ingegno e la mente aperta per trovare le migliori soluzioni.



Continuous innovation: We ensure close cooperation with our customers worldwide.

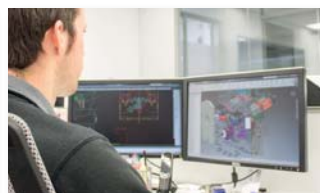

Innovation non-stop:

Nous assurons une étroite coopération avec nos clients dans le monde entier.

Innovazione continua:

Garantiamo una stretta collaborazione con i nostri clienti in tutto il mondo.

# Special products

Design and production according to the customer specifications. More than 8000 special designed and manufactured heads as per our customer's requirements.

Conception et fabrication selon les spécifications des clients. Plus de 8000 types spéciaux fabriqués.

Progettazione e produzione secondo le specifiche del cliente. Più di 8000 offerte speciali progettate su misura.



# Wide range of solutions



Heads & accessories



Angle heads



Spindle speeders



Live tooling for CNC lathes



Live tooling for swiss type lathes



High frequency spindles