



PROETI

Producción de Equipos Técnicos e Industriales, S.A
Ctra. Algete M-106, Km 4,100. 28110. Algete - (Madrid) - ESPAÑA

Telephone: +34 91 628 29 40

Fax: +34 91 629 00 59

Apartado de Correos N°2. Algete

www.proetisa.com



6

Material Testing Equipment



Material Testing Equipment

PROETI



Proeti - who we are

Proeti opened its business in 1985 manufacturing laboratory equipment for the control and testing of construction materials used in Civil Engineering projects. Since then we have been able to cover a complete range of testing equipment for Concrete, Cement, Asphalt, Steel, Rock, Aggregates and Soils. Our mission is to offer our clients personalised attention by analysing their needs and providing solutions by using the experience and knowledge we have acquired over more than 23 years.

Our offices are located 25 km from Madrid, well communicated by road and very near the International Airport and one of largest train stations in the city. Our facilities cover an area of 2300 m² that include 5 buildings for manufacturing, storage, packaging, offices, a calibration laboratory, a conference room, an exhibition area and a technical service area.



Our mission

To manufacture the most advanced laboratory equipment for our clients. To this end, in Proeti we have developed a business culture founded on the following Principles:

Solution factory

At Proeti, all our services and products are directed towards satisfying the needs of our clients. Therefore, this is the main theme of our company's activity. Rather than being a challenge, the principle is a strategic priority of the first order. Proeti operates as an agile and efficient "Solution Factory".

Mandatory quality

This aspect must be the predominant mandatory principle in all the business areas of the company, from the design and production of our products to marketing and customer service. This principle translates into a philosophy of continuous improvement.

Search for creativity

Proeti constantly searches for ways to increase its level of competitiveness and dynamics by the permanent application of creativity, leading to the development of new lines of production and service, based on strict policies that promote Research and Development.

Internal cohesion

At Proeti, the main asset we have for attaining our goals are our employees. Proeti is a closely knit family company that recognises the value and potential for progress and leadership of all the individuals on our staff. Thus, our constant effort to generate an environment that features the cohesion, integration and commitment of all our personnel.

Business culture and values

The complete satisfaction of our clients is our priority and *raison d'être*.

Design flexibility allows us to adapt to the needs of our clients in a market undergoing continuous change.

Quality, founded on the professionalism of Proeti's staff, is the mainstay of our relationship with our clients.

Prominent alliances with our distributors.

Investment in the qualification and certification of all company personnel.

The search for excellence through service.

We offer personalised solutions to the needs of our clients through our team of technicians, who are highly experienced in the various technological areas that we cover.



Research and development

At Proeti, we have progressed to the point of becoming a leading manufacturing company in our sector. The importance given to innovation in Proeti is so crucial that we can affirm without doubt that all our product lines have been the result of our work in R+D. This requirement for innovation has been the single most important factor in our position as a leading manufacturer of Material Testing and Control Equipment.



Quality policy

At Proeti, S.A, our commitment to quality is not new. In fact, in 1996 we were one of the first companies to be certified as an "ENAC Calibration Laboratory", and in 1999 our quality assurance system obtained the ISO 9001 certification. Since then, Proeti, S.A. has continued making progress in the implementation of measures that guarantee the quality of all its processes.

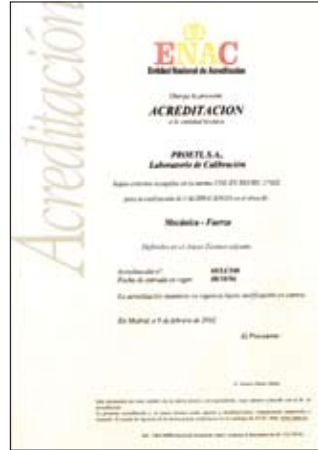

Customer service

Within the framework of Proeti, S.A. Principles and Values, we consider our commitment to quality as one of the principle strategic pillars of our business activity. This quality is always oriented towards the complete confidence of our clients in the company, whether directly, through a system that guarantees unsurpassed attention to their needs, or indirectly, through a policy of internal and external communication where the client is our main concern and *raison d'etre*. As evidence, at Proeti we are not only concerned about certifying our Quality System, but about performing the necessary tests and certifications of our products in the corresponding approved institutions according to current standards so that our clients can be sure at all times that they are purchasing products of total confidence.

International presence

In recent years, Proeti has pursued a geographical diversification and growth strategy oriented to markets with high development potential, where our company can capitalise its capacity and experience to obtain significant market presence.

Our philosophy in those countries we are present in is to adapt to the internal market by designing, manufacturing and marketing products that serve the needs and purchasing power of our clients.

In the coming years, we will continue to analyse new opportunities to enter foreign markets that allow us to grow, because we are convinced that part of the growth of the company must come from a presence in the international market that creates opportunities for Proeti to compete in the future of a world that is becoming increasingly smaller.

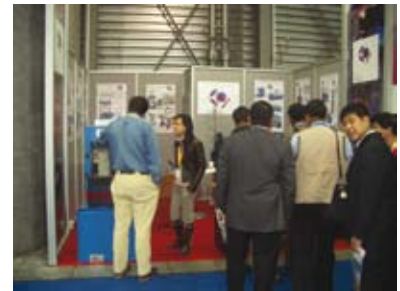

How to find proeti

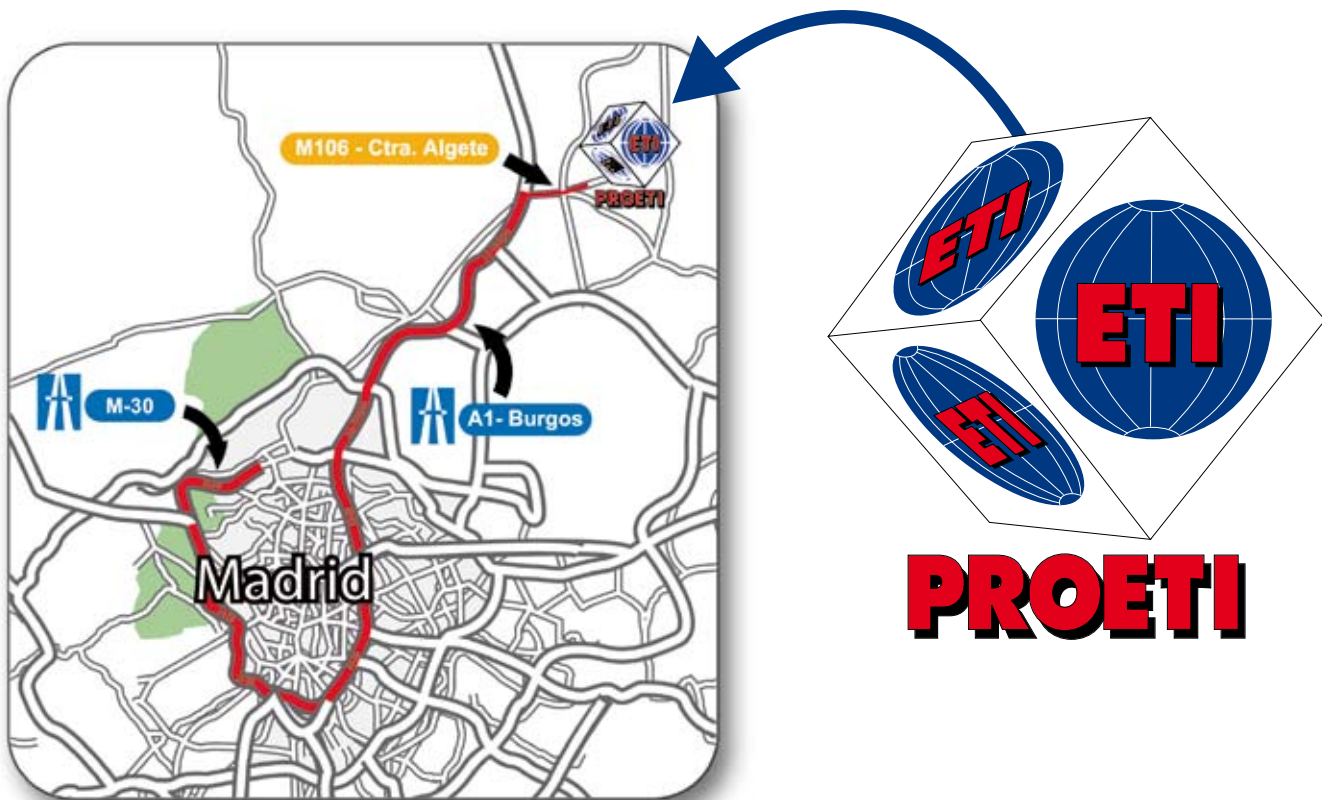

PROETI, S.A.

Producción de Equipos Técnicos e Industriales, S.A

Ctra. Algete M-106, Km 4,100. 28110. Algete. Madrid. SPAIN

Phone 34 916282940

Fax 34 916290059

P.O. Box No.2. Algete

E-mail: comercial@proetisa.com, commercial@proetisa.com, export@proetisa.com, s.tecnico@proetisa.com, calidad@proetisa.com, nuclear@proetisa.com

Website www.proetisa.com

New new website

New web page, divided into sections for real time access to all the new products developed by Proetisa.

Our "ON LINE catalogue" section offers access to all the equipment, accessories and spare parts manufactured by Proeti, as well as quote requests and any other information that you may need.

Our download section offers access to our most recent software, manuals, etc



table of contents

1

weighing and drying techniques

2

rocks and aggregates

3

cements

4

concrete

5

soils

6

bitumens

7

steels

8

general material

1

WEIGHING AND DRYING TECHNIQUES



Electronic scales

Analytical scales

Autocalibration with internal weight (except P0001/1)
 Reset the entire reading range.
 RS-232 interface.
 ± 0.0001 g linearity.
 Operating temperature 14/40° C.
 Equipped for hydrostatic weighing.

Model	Capacity	Precision	Plate	Weight
P0001/1	110 g	0.0001 g	8.5 cm	7 kg
P0001/2	210 g	0.0001 g	8.5 cm	7 kg
P0001/3	310 g	0.0001 g	8.5 cm	7 kg
P0001/4	510 g	0.001 g	8.5 cm	7 kg



Electronic scales I

With full scale automatic calibration.
 RS-232 I/O data output.
 On/off display.
 Graphic bar indicating the position and scale used.
 Response time: 2-3 seconds.
 Operating temperature: 10 - 40° C.
 Voltage: 220 V. +10% with external power supply.
 Consumption: 14 VA.

Accessories

P0032 Hydrostatic weighing hook.

Model	Capacity	Precision	Plate	Weight
P0003	510 g	0.001 g	110 mm	5.8 kg
P0004	620 g	0.01 g	150 mm	5.8 kg
P0005	1,000 g	0.01 g	150 mm	5.8 kg
P0006	3,200 g	0.01 g	150 mm	5.8 kg
P0007	3,300 g	0.1 g	190 mm	5.8 kg
P0008	2000 / 4000 g	0.01 / 0.1 g	150 mm	5.8 kg
P0009	6,300 g	0.1 g	190 mm	5.8 kg
P0010	8,500 g	0.1 g	190 mm	5.8 kg



Electronic scales II

Scales with high internal resolution: 1/60,000.
 Software calibrated.
 Power supply: 110 v, 220v + 10%.
 Full range tare function.
 Weights in: grams, pounds or ounces
 Optional modules: Mini-Printer Interface. RS232C.
 Internal module for printer: DP-343.
 Keypad with buttons.
 Internal rechargeable battery.
 Measurements: 390x345x120 mm.

Model	Capacity	Precision	Plate
P0020	30 kg	1 g	320x240 mm
P0020/1	15 kg	0.5 g	320x240 mm
P0020/2	6 kg	0.2 g	320x240 mm



Electronic scales III

Full scale automatic calibration with external mass.
 Full range tare function.
 2/3 second stabilisation time.
 Power supply: 220 V ± 10% with external power supply.
 Operating temperature: 10 - 40° C.
 Operation with relative humidity of up to 85%.
 RS232 output.

Model	Capacity	Precision	Plate
P0028	25 kg	0.5 g	400x500 mm
P0028/1	6.5 / 35 Kg	0.1 / 1 g	400x400 mm
P0028/2	50 kg	1 g	400x500 mm



Large capacity electronic scales

Large capacity electronic scales

- Part counter function.
- Software calibrated with external weights.
- Full range tare function.
- IP 66 load cell.
- Stainless steel platform.
- Internal rechargeable battery with 120h in standby mode.
- Power supply: 110/220 V.
- Optional: RS232C.

Model	Capacity	Precision	Plate
P0024	100 kg	10 g	442x332 mm
P0024/1	60 kg	5/10 g	442x332 mm
P0024/2	30 kg	5/10 g	442x332 mm
P0024/3	15 kg	1/2 g	442x332 mm

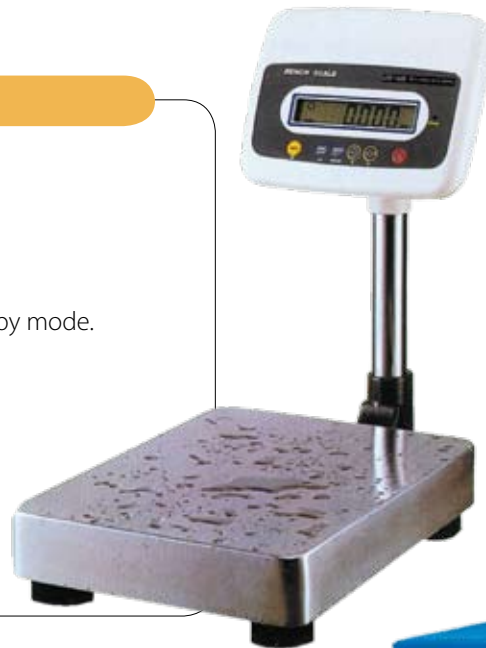

P0030 Hydrostatic weighing frame

BS 812/2 -1881:114. ASTM C127. AASHTO T85. EN 12390/7

The hydrostatic weighing system consists of a rigid frame which includes a water tank mounted upon a platform. A mechanical lifting system allows the water tank to be raised in order to submerge the sample suspended beneath the scale. (not included with the equipment).

Approx. measurements: 510 x 510 x 1150 mm.

Weight: 50 kg.

Accessories

P0030/1 Support for suspending test cubes and cylinders.

A0565 Stainless steel basket of Ø 200 x 200, with 3.35 mm mesh.

Spares:

P0030/2 Bucket for hydrostatic weighing.



P0031 Anti-vibration table for scales

Equipped with an anti-vibration system that is independent from the rest of the table. It comprises a large inertial mass that rests on the vibration and impact damper elements. It has a capacity to absorb more than 90% of the amplitude of vibrations with frequencies in excess of 750 cycles / minute. The unit is manufactured from melamine and stratified laminates. The auxiliary work panel is post-formed and hollow, with a stainless steel or treated aluminium edge moulding.

Approx. measurements: 100 x 80 x 90 cm.



Mechanical precision scales

Scales designed in accordance with the specifications required by construction industry laboratories.

P0050 CENT – 0 - GRAM SCALES

Supplied complete with stainless steel plate.

Capacity: 310 g.

Sensitivity: 0,01 g.

Weight: 3 kg.



Triple beam mechanical scales

Complete with stainless steel plate, tare device and set of weights.

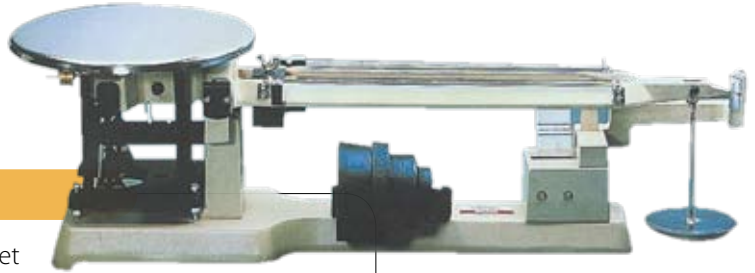

Model	Capacity	Precision	Plate
P0060	20 kg	1 g	280 mm
P0062	2,610 g	0.1 g	150 mm

Platform scales

Automatic scales

Automatic scales with clear and direct reading. Full metal structure, with digital display.

Model	Capacity	Precision	Plate
P0090	60 kg	5/10 g	430x530 mm
P0091	150 kg	20 g	430x530 mm
P0092	300 kg	50 g	430x530 mm
P0093	600 kg	200 g	450x600 mm



Dynamometers

2 second stabilisation time. Approximate net weight: 250 gr. Power supplied with 9 V battery included.

Measurements: 90x80x30 mm.
Total length including hook: 105 mm.



Model	Capacity	Precision
P0100	15 kg	20 g
P0101	25 kg	50 g
P0102	50 kg	50 g

Sets of weights

Set of weights

In order to control and verify the weighing equipment used in laboratories, the high quality and precision of the calibration masses is essential. The weights are classified according to the tolerance or maximum permissible error. The material used and the quality of finish affect their classification. The weights are manufactured from stainless steel or chrome plated brass (cast iron) of the following classes: E1; E2; F1; F2; M1; M2. On request, each set can be supplied with a Traceability Certificate issued by an accredited mass laboratory.



P0154 ENAC calibration certificate

JX-100	JX-200	JX-500	JX-1000	JX-2000	JX-5000	JX-100000
50 g	100 g	200 g	500 g	1000 g	2000 g	5000 g
20 g	50 g	100 g	200 g	500 g	1000 g	2000 g
10 g	20 g	100 g	100 g	200 g	1000 g	1000 g
10 g	10 g	50 g	100 g	100 g	500 g	1000 g
5 g	10 g	20 g	50 g	100 g	200 g	500 g
2 g	5 g	10 g	20 g	50 g	100 g	200 g
2 g	2 g	10 g	10 g	20 g	100 g	100 g
1 g	2 g	5 g	10 g	10 g	50 g	100 g
500 mg	1 g	2 g	5 g	10 g	20 g	50 g
200 mg	500 mg	2 g	2 g	5 g	10 g	20 g
200 mg	200 mg	1 g	2 g	2 g	10 g	10 g
100 mg	200 mg	500 mg	1 g	2 g	5 g	10 g
50 mg	100 mg	200 mg	500 mg	1 g	2 g	5 g
20 mg	50 mg	200 mg	200 mg	500 mg	2 g	2 g
20 mg	20 mg	100 mg	200 mg	200 mg	1 g	2 g
10 mg	20 mg	50 mg	100 mg	200 mg	500 mg	1g
5 mg	10 mg	20 mg	50 mg	100 mg	200 mg	500 mg
2 mg	5 mg	20 mg	20 mg	50 mg	200 mg	200 mg
2 mg	2 mg	10 mg	20 mg	20 mg	100 mg	200 mg
1 mg	2 mg	5 mg	10 mg	20 mg	50 mg	100 mg
	1 mg	2 mg	5 mg	10 mg	20 mg	50 mg
		2 mg	5 mg	5 mg	20 mg	50 mg
		1 mg	2 mg	2 mg	10 mg	20 mg
			2 mg	2 mg	5 mg	20 mg
			1 mg	1 mg	2 mg	5 mg
					2 mg	2 mg
					1 mg	2 mg
						1 mg

Class f1 individual chrome plated brass weights, case included. OIML densities

Model	Capacity
P0163/1	1 g
P0163/2	2 g
P0163/3	5 g
P0163/4	10 g
P0163/5	20 g
P0163/6	50 g
P0163/7	100 g
P0163/8	200 g
P0163/9	500 g
P0163/10	1,000 g
P0163/11	2,000 g
P0163/12	5,000 g
P0163/13	10,000 g
P0163/14	20,000 g

Drying ovens

Ovens with analogue indicator and control.

These ovens have been specially designed for drying large quantities of samples. Adjustable temperatures ranging from ambient temperature to 200°C ± 1° C. Convection or forced air circulation (as requested). Metal structure with double chamber and thermal insulation. Internal enclosure, trays and stainless steel baffle door. Control panel comprising start-up switch, indication lights, temperature regulation thermostat and front precision thermometer. Supplied with two trays with adjustable height supports.

Model	Capacity	Internal measurements	External measurements	Power
P0200 (NC)	36 l.	40 x 30 x 30 cm	67 x 43 x 43 cm	28 kg 1,100 W
P0201 (NC)	80 l.	50 x 40 x 40 cm	77 x 53 x 53 cm	42 kg 1,600 W
P0202 (FA)	80 l.	50 x 40 x 35 cm	77 x 53 x 53 cm	42 kg 1,600 W
P0203 (NC)	150 l.	50 x 60 x 50 cm	77 x 90 x 68 cm	63 kg 2,000 W
P0204 (FA)	150 l.	50 x 60 x 45 cm	77 x 90 x 68 cm	63 kg 2,000 W
P0205 (FA)	216 l.	60 x 60 x 60 cm	87 x 110 x 68 cm	80 kg 3,600 W
P0206 (FA)	288 l.	80 x 60 x 60 cm	108 x 110 x 78 cm	92 kg 3,600 W
P0207 (FA)	400 l.	100 x 80 x 50 cm	140 x 145 x 75 cm	125 kg 4,100 W
P0208 (FA)	720 l.	120 x 100 x 60 cm	160 x 165 x 85 cm	170 kg 5,000 W

NC Natural convection
FA Forced air.



Drying ovens

Ovens with electronic - digital control

These ovens have been specially designed for drying large quantities of samples. Adjustable temperatures ranging from ambient temperature to 200°C ± 1° C. Convection or forced air circulation (as requested). Metal structure with double chamber and thermal insulation. Internal enclosure, trays and stainless steel baffle door. Control panel comprising start-up switch, indication lights, temperature regulation thermostat and front precision thermometer. Supplied with two trays with adjustable height supports.

Model	Capacity	Internal measurements	External measurements	Power
P0220 (NC)	36 l.	40 x 30 x 30 cm	67 x 43 x 43 cm	28 kg 1,100 W
P0221 (FA)	36 l.	40 x 30 x 30 cm	67 x 43 x 43 cm	28 kg 1,100 W
P0222 (NC)	80 l.	50 x 40 x 40 cm	77 x 53 x 53 cm	42 kg 1,600 W
P0223 (FA)	80 l.	50 x 40 x 40 cm	77 x 53 x 53 cm	42 kg 1,600 W
P0224 (NC)	150 l.	50 x 60 x 50 cm	77 x 90 x 68 cm	63 kg 2,000 W
P0225 (FA)	150 l.	50 x 60 x 50 cm	77 x 90 x 68 cm	63 kg 2,000 W
P0226 (FA)	216 l.	60 x 60 x 60 cm	87 x 110 x 68 cm	80 kg 3,600 W
P0227 (FA)	288 l.	80 x 60 x 60 cm	108 x 110 x 78 cm	92 kg 3,600 W
P0228 (FA)	400 l.	100 x 80 x 50 cm	140 x 145 x 75 cm	125 kg 4,100 W
P0229 (FA)	720 l.	120 x 100 x 60 cm	160 x 165 x 85 cm	170 kg 5,000 W



Cabinet type ovens

This type of oven has the same structure and regulation characteristics as the aforementioned models. Manufactured for adjustable temperatures ranging from ambient temperature up to 200° C. Temperature control and regulation can be analogue or digital. Air circulation is guaranteed by a motor that produces horizontal air flow, thus accelerating the drying process. These ovens are made to order, based on the customer's capacity and control requirements.

Heating plates

Rectangular digital heating plates

Plate built from non-deformable steel plate
Metal unit painted in epoxy paint. Heating elements are uniformly distributed over the entire plate, providing good temperature homogeneity. Adjustable plate temperatures up to 400°C (200°C depending on model). Digital regulation temperature control and 4 digit display. 1°C resolution. Manufactured in accordance with EC directives.



Model	Control	Plate measurements	External measurements	Temperature	Power
V0125	Digital	200 x 400 mm	190 x 220 x 480 mm	400 °C	2,000 W
V0126	Digital	250 x 500 mm	190 x 280 x 580 mm	400 °C	3,000 W

V0130 Circular heating plates

Non-deformable steel circular heating plate. Injected outer unit painted with epoxy paint. Includes safety thermostat which disconnects the plate if the temperature exceeds 350°C. Electronic voltage regulation allows power to be adjusted between 10% and 100%. As an optional accessory it can include a connection for a contact thermometer or digital programmer installed at the back. Equipped with an illuminated on switch and a resistor operation indication light. Manufactured in accordance with EC directives.



Accessories

- V0130/1** Support rod 12 x 450 mm.
- V0130/2** Rear socket for contact thermometer.
- V0130/3** TCD-1 (Digital contact thermometer).

Quick drying methods

P0250 Hot air dryer

Used to dry small amounts of soil and aggregates, as well as for other general laboratory uses.

Approximate weight: 1.6 kg.



P0254 Microwave oven

Specially designed for quick drying and for general laboratory use.

Measurements: 460 x 330 x 300 mm (h x a x f).



P0255 Electronic scale. Humidity determination. 200 g Sensitivity 0.001g.

Temperature selection from 50° to 180° C.
 Time selection: 1 minute to 999 minutes.
 Automatic assessment of the sample stable weight when it has lost its humidity.
 Dry residue % and wet residue % on screen indication.
 Able to record five samples in the memory.
 Minimum sample weight: 140 mg, Maximum 200g.
 Acoustic warning when the test is complete.
 RS-232 data output.
 Optional printer.
 Humidity accuracy: ± 0.01 %.
 Includes: aluminium plates / special sample pincers, two extra plates.
 This model has three screens to facilitate the sampling process.



2

ROCKS AND AGGREGATES



Sample preparation

Trays

Sampling trays made of galvanised sheet metal or stainless steel

Dimensions

Galvanised sheet metal	Stainless steel	Dimensions
A0001	A0010	20 x 20 x 5 cm
A0002	A0011	40 x 20 x 5 cm
A0003	A0012	40 x 40 x 5 cm
A0004	A0013	60 x 40 x 5 cm
A0005	A0014	60 x 60 x 5 cm
A0006	A0015	100 x 100 x 5 cm



Standards EN 933/1, 933/2 – UNE 7050/3, 7050/4 – ISO 3310/1, 3310/2, 9044 - BS 410 DIN 4187 – NF X11-504 – AASHTO T27 - ASTM E11

Sieves with steel mesh



Mesh size		Frame diameter (mm) / References							
ISO 3310/1	ASTM E-11	Ø 200	Ø 8	Ø 250	Ø 300	Ø 12"	Ø 315	Ø 400	Ø 450
0.032 mm		A1100	A1200	A1300	A1400	A1500	A1600	A1700	A1800
0.038 mm	No. 400	A1101	A1201	A1301	A1401	A1501	A1601	A1701	A1801
0.040 mm		A1102	A1202	A1302	A1402	A1502	A1602	A1702	A1802
0.045 mm	No. 325	A1103	A1203	A1303	A1403	A1503	A1603	A1703	A1803
0.050 mm		A1104	A1204	A1304	A1404	A1504	A1604	A1704	A1804
0.053 mm	No. 270	A1105	A1205	A1305	A1405	A1505	A1605	A1705	A1805
0.056 mm		A1106	A1206	A1306	A1406	A1506	A1606	A1706	A1806
0.063 mm	No. 230	A1107	A1207	A1307	A1407	A1507	A1607	A1707	A1807
0.071 mm		A1108	A1208	A1308	A1408	A1508	A1608	A1708	A1808
0.075 mm	No. 200	A1109	A1209	A1309	A1409	A1509	A1609	A1709	A1809
0.080 mm		A1110	A1210	A1310	A1410	A1510	A1610	A1710	A1810
0.090 mm	No. 170	A1111	A1211	A1311	A1411	A1511	A1611	A1711	A1811
0.100 mm		A1112	A1212	A1312	A1412	A1512	A1612	A1712	A1812
0.106 mm	No. 140	A1113	A1213	A1313	A1413	A1513	A1613	A1713	A1813
0.112 mm		A1114	A1214	A1314	A1414	A1514	A1614	A1714	A1814
0.125 mm	No. 120	A1115	A1215	A1315	A1415	A1515	A1615	A1715	A1815
0.140 mm		A1116	A1216	A1316	A1416	A1516	A1616	A1716	A1816
0.150 mm	No. 100	A1117	A1217	A1317	A1417	A1517	A1617	A1717	A1817
0.160 mm		A1118	A1218	A1318	A1418	A1518	A1618	A1718	A1818

Mesh size		Frame diameter (mm) / References							
ISO 3310/1	ASTM E-11	Ø 200	Ø 8	Ø 250	Ø 300	Ø 12"	Ø 315	Ø 400	Ø 450
0.180 mm	No. 80	A1119	A1219	A1319	A1419	A1519	A1619	A1719	A1819
0.200 mm		A1120	A1220	A1320	A1420	A1520	A1620	A1720	A1820
0.212 mm	No. 70	A1121	A1221	A1321	A1421	A1521	A1621	A1721	A1821
0.224 mm		A1122	A1222	A1322	A1422	A1522	A1622	A1722	A1822
0.250 mm	No. 60	A1123	A1223	A1323	A1423	A1523	A1623	A1723	A1823
0.280 mm		A1124	A1224	A1324	A1424	A1524	A1624	A1724	A1824
0.300 mm	No. 50	A1125	A1225	A1325	A1425	A1525	A1625	A1725	A1825
0.315 mm		A1126	A1226	A1326	A1426	A1526	A1626	A1726	A1826
0.355 mm	No. 45	A1127	A1227	A1327	A1427	A1527	A1627	A1727	A1827
0.400 mm		A1128	A1228	A1328	A1428	A1528	A1628	A1728	A1828
0.425 mm	No. 40	A1129	A1229	A1329	A1429	A1529	A1629	A1729	A1829
0.450 mm		A1130	A1230	A1330	A1430	A1530	A1630	A1730	A1830
0.500 mm	No. 35	A1131	A1231	A1331	A1431	A1531	A1631	A1731	A1831
0.560 mm		A1132	A1232	A1332	A1432	A1532	A1632	A1732	A1832
0.600 mm	No. 30	A1133	A1233	A1333	A1433	A1533	A1633	A1733	A1833
0.630 mm		A1134	A1234	A1334	A1434	A1534	A1634	A1734	A1834
0.710 mm	No. 25	A1135	A1235	A1335	A1435	A1535	A1635	A1735	A1835
0.800 mm		A1136	A1236	A1336	A1436	A1536	A1636	A1736	A1836
0.850 mm	No. 20	A1137	A1237	A1337	A1437	A1537	A1637	A1737	A1837
0.900 mm		A1138	A1238	A1338	A1438	A1538	A1638	A1738	A1838
1.00 mm	No. 18	A1139	A1239	A1339	A1439	A1539	A1639	A1739	A1839
1.12 mm		A1140	A1240	A1340	A1440	A1540	A1640	A1740	A1840
1.18 mm	No. 16	A1141	A1241	A1341	A1441	A1541	A1641	A1741	A1841
1.25 mm		A1142	A1242	A1342	A1442	A1542	A1642	A1742	A1842
1.40 mm	No. 14	A1143	A1243	A1343	A1443	A1543	A1643	A1743	A1843
1.60 mm		A1144	A1244	A1344	A1444	A1544	A1644	A1744	A1844
1.70 mm	No. 12	A1145	A1245	A1345	A1445	A1545	A1645	A1745	A1845
1.80 mm		A1146	A1246	A1346	A1446	A1546	A1646	A1746	A1846
2.00 mm	No. 10	A1147	A1247	A1347	A1447	A1547	A1647	A1747	A1847
2.24 mm		A1148	A1248	A1348	A1448	A1548	A1648	A1748	A1848
2.36 mm	No. 8	A1149	A1249	A1349	A1449	A1549	A1649	A1749	A1849
2.50 mm		A1150	A1250	A1350	A1450	A1550	A1650	A1750	A1850
2.80 mm	No. 7	A1151	A1251	A1351	A1451	A1551	A1651	A1751	A1851
3.15 mm		A1152	A1252	A1352	A1452	A1552	A1652	A1752	A1852
3.35 mm	No. 6	A1153	A1253	A1353	A1453	A1553	A1653	A1753	A1853
3.55 mm		A1154	A1254	A1354	A1454	A1554	A1654	A1754	A1854
4.00 mm	No. 5	A1155	A1255	A1355	A1455	A1555	A1655	A1755	A1855
4.50 mm		A1156	A1256	A1356	A1456	A1556	A1656	A1756	A1856
4.75 mm	No. 4	A1157	A1257	A1357	A1457	A1557	A1657	A1757	A1857
5.00 mm		A1158	A1258	A1358	A1458	A1558	A1658	A1758	A1858
5.60 mm	No. 3½"	A1159	A1259	A1359	A1459	A1559	A1659	A1759	A1859
6.30 mm	1/4"	A1160	A1260	A1360	A1460	A1560	A1660	A1760	A1860
6.70 mm	0.265"	A1161	A1261	A1361	A1461	A1561	A1661	A1761	A1861
7.10 mm		A1162	A1262	A1362	A1462	A1562	A1662	A1762	A1862
8.00 mm	5/16"	A1163	A1263	A1363	A1463	A1563	A1663	A1763	A1863

Mesh size		Frame diameter (mm) / References							
ISO 3310/1	ASTM E-11	Ø 200	Ø 8	Ø 250	Ø 300	Ø12"	Ø 315	Ø 400	Ø 450
9.00 mm		A1164	A1264	A1364	A1464	A1564	A1664	A1764	A1864
9.50 mm	3/8"	A1165	A1265	A1365	A1465	A1565	A1665	A1765	A1865
10.00 mm		A1166	A1266	A1366	A1466	A1566	A1666	A1766	A1866
11.20 mm	7/16"	A1167	A1267	A1367	A1467	A1567	A1667	A1767	A1867
12.50 mm	1/2"	A1168	A1268	A1368	A1468	A1568	A1668	A1768	A1868
13.20 mm	0.530"	A1169	A1269	A1369	A1469	A1569	A1669	A1769	A1869
14.00 mm		A1170	A1270	A1370	A1470	A1570	A1670	A1770	A1870
16.00 mm	5/8"	A1171	A1271	A1371	A1471	A1571	A1671	A1771	A1871
18.00 mm		A1172	A1272	A1372	A1472	A1572	A1672	A1772	A1872
19.00 mm	3/4"	A1173	A1273	A1373	A1473	A1573	A1673	A1773	A1873
20.00 mm		A1174	A1274	A1374	A1474	A1574	A1674	A1774	A1874
22.40 mm	7/8"	A1175	A1275	A1375	A1475	A1575	A1675	A1775	A1875
25.00 mm	1"	A1176	A1276	A1376	A1476	A1576	A1676	A1776	A1876
25.40 mm		A1177	A1277	A1377	A1477	A1577	A1677	A1777	A1877
26.50 mm	1.06"	A1178	A1278	A1378	A1478	A1578	A1678	A1778	A1878
28.00 mm		A1179	A1279	A1379	A1479	A1579	A1679	A1779	A1879
31.50 mm	1¼"	A1180	A1280	A1380	A1480	A1580	A1680	A1780	A1880
35.50 mm		A1181	A1281	A1381	A1481	A1581	A1681	A1781	A1881
37.50 mm	1½"	A1182	A1282	A1382	A1482	A1582	A1682	A1782	A1882
40.00 mm		A1183	A1283	A1383	A1483	A1583	A1683	A1783	A1883
45.00 mm	1¾"	A1184	A1284	A1384	A1484	A1584	A1684	A1784	A1884
50.00 mm	2"	A1185	A1285	A1385	A1485	A1585	A1685	A1785	A1885
53.00 mm	2.12"	A1186	A1286	A1386	A1486	A1586	A1686	A1786	A1886
56.00 mm		A1187	A1287	A3187	A1487	A1587	A1687	A1787	A1887
63.00 mm	2½"	A1188	A1288	A1388	A1488	A1588	A1688	A1788	A1888
71.00 mm		A1189	A1289	A1389	A1489	A1589	A1689	A1789	A1889
75.00 mm	3"	A1190	A1290	A1390	A1490	A1590	A1690	A1790	A1890
80.00 mm		A1191	A1291	A1391	A1491	A1591	A1691	A1791	A1891
90.00 mm	3½"	A1192	A1292	A1392	A1492	A1592	A1692	A1792	A1892
100.0 mm	4"	A1193	A1293	A1393	A1493	A1593	A1693	A1793	A1893
106.0 mm		A1194	A1294	A1394	A1494	A1594	A1694	A1794	A1894
112.0 mm		A1195	A1295	A1395	A1495	A1595	A1695	A1795	A1895
125.0 mm	5"	A1196	A1296	A1396	A1496	A1596	A1696	A1796	A1896
Bottom		A1198	A1298	A1398	A1498	A1598	A1698	A1798	A1898
Cover		A1199	A1299	A1399	A1499	A1599	A1699	A1799	A1899



Sieves made of perforated sheet metal

Mesh size		Frame diameter (mm) / References							
ISO 3310/1	ASTM E-11	Ø 200	Ø 8	Ø 250	Ø 300	Ø 12"	Ø 315	Ø 400	Ø 450
4.00 mm	No. 5	A2000	A2100	A2200	A2300	A2400	A2500	A2600	A2700
4.50 mm		A2001	A2101	A2201	A2301	A2401	A2501	A2601	A2701
4.75 mm	No. 4	A2002	A2102	A2202	A2302	A2402	A2502	A2602	A2702
5.00 mm		A2003	A2103	A2203	A2303	A2403	A2503	A2603	A2703
5.60 mm	No. 3½	A2004	A2104	A2204	A2304	A2404	A2504	A2604	A2704
6.30 mm	1/4"	A2005	A2105	A2205	A2305	A2405	A2505	A2605	A2705
6.70 mm	0.265"	A2006	A2106	A2206	A2306	A2406	A2506	A2606	A2706
7.10 mm		A2007	A2107	A2207	A2307	A2407	A2507	A2607	A2707
8.00 mm	5/16"	A2008	A2108	A2208	A2308	A2408	A2508	A2608	A2708
9.00 mm		A2009	A2109	A2209	A2309	A2409	A2509	A2609	A2709
9.50 mm	3/8"	A2010	A2110	A2210	A2310	A2410	A2510	A2610	A2710
10.00 mm		A2011	A2111	A2211	A2311	A2411	A2511	A2611	A2711
11.20 mm	7/16"	A2012	A2112	A2212	A2312	A2412	A2512	A2612	A2712
12.50 mm	1/2"	A2013	A2113	A2213	A2313	A2413	A2513	A2613	A2713
13.20 mm	0.530"	A2014	A2114	A2214	A2314	A2414	A2514	A2614	A2714
14.00 mm		A2015	A2115	A2215	A2315	A2415	A2515	A2615	A2715
16.00 mm	5/8"	A2016	A2116	A2216	A2316	A2416	A2516	A2616	A2716
18.00 mm		A2017	A2117	A2217	A2317	A2417	A2517	A2617	A2717
19.00 mm	3/4"	A2018	A2118	A2218	A2318	A2418	A2518	A2618	A2718
20.00 mm		A2019	A2119	A2219	A2319	A2419	A2519	A2619	A2719
22.40 mm	7/8"	A2020	A2120	A2220	A2320	A2420	A2520	A2620	A2720
25.00 mm	1"	A2021	A2121	A2221	A2321	A2421	A2521	A2621	A2721
26.50 mm	1.06"	A2022	A2122	A2222	A2322	A2422	A2522	A2622	A2722
28.00 mm		A2023	A2123	A2223	A2323	A2423	A2523	A2623	A2723
31.50 mm	1¼"	A2024	A2124	A2224	A2324	A2424	A2524	A2624	A2724
35.50 mm		A2025	A2125	A2225	A2325	A2425	A2525	A2625	A2725
37.50 mm	1½"	A2026	A2126	A2226	A2326	A2426	A2526	A2626	A2726
40.00 mm		A2027	A2127	A2227	A2327	A2427	A2527	A2627	A2727
45.00 mm	1¾"	A2028	A2128	A2228	A2328	A2428	A2528	A2628	A2728
50.00 mm	2"	A2029	A2129	A2229	A2329	A2429	A2529	A2629	A2729
53.00 mm	2.12"	A2030	A2130	A2230	A2330	A2430	A2530	A2630	A2730
56.00 mm		A2031	A2131	A2231	A2331	A2431	A2531	A2631	A2731
63.00 mm	2½"	A2032	A2132	A2232	A2332	A2432	A2532	A2632	A2732
71.00 mm		A2033	A2133	A2233	A2333	A2433	A2533	A2633	A2733
75.00 mm	3"	A2034	A2134	A2234	A2334	A2434	A2534	A2634	A2734
80.00 mm		A2035	A2135	A2235	A2335	A2435	A2535	A2635	A2735
90.00 mm	3½"	A2036	A2136	A2236	A2336	A2436	A2536	A2636	A2736
100.0 mm	4"	A2037	A2137	A2237	A2337	A2437	A2537	A2637	A2737
106.0 mm	4.24"	A2038	A2138	A2238	A2338	A2438	A2538	A2638	A2738
112.0 mm		A2039	A2139	A2239	A2339	A2439	A2539	A2639	A2739
125.0 mm	5"	A2040	A2140	A2240	A2340	A2440	A2540	A2640	A2740
125.0 mm	5"	A2040	A2140	A2240	A2340	A2440	A2540	A2640	A2740

Wet sieving

Sieve for wet sieving fine materials

A0460

Made entirely of stainless steel with a ring measuring Ø 200 x 100 mm high and mesh size ASTM No. 200 (0.074 mm).

A0461

Made entirely of stainless steel with a ring measuring Ø 200 x 200 mm high and mesh size ASTM No. 200 (0.074 mm).



Cover and bottom

Made entirely of stainless steel for wet sieving. Consisting of a cover with water intake and a bottom with drainage outlet.

A0462

Cover and bottom Ø 200 mm.

A0463

Cover and bottom Ø 8".

A0464

Cover and bottom Ø 250 mm.

A0465

Cover and bottom Ø 300 mm.

A0466

Cover and bottom Ø 12".

A0467

Cover and bottom Ø 315 mm.

A0468

Cover and bottom Ø 400 mm.

A0469

Cover and bottom Ø 450 mm.

A0500 Ultrasound bath for sieve cleaning

Designed for maintenance and cleaning of sieves, glass and other laboratory instruments. Made of AISI 304 stainless steel and equipped with a heater, 0° - 90°C adjustable, timer, drain and two operating powers.

Capacity: 9 litres.

Power supply: 220 V. / 50 Hz.

Internal dimensions: 300 x 240 x 150 mm.

External dimensions: 300 x 270 x 370 mm.



Sieve brushes

A0501 Soft hair brush.

A0501/1 Soft hair brush Ø 3 mm (BS 812)

A0502 Tin bristle brush.

A0502/1 Tin and nylon bristle brush.

A0503 Round brush with bristles Ø 30 mm.

A0503/1 Flat brush with soft hair bristle.

A0503/2 Flat brush with nylon.



Standards UNE 933, -1

The equipment described below has been designed and manufactured to facilitate laborious sieving work, thus providing better and more homogeneous results.

A0505 Rocking sieve shaker

Holds up to 6 sieves measuring \varnothing 200 or 8" x 2" high, plus bottom and cover. Powered by an electric motor that transmits movement via a belt to the eccentric shaft. The machine includes a connection box and main on/off switch. The base has 4 anti-vibration legs.

Power supply: 220 V. 50/60 Hz.

Dimensions: 700 x 360 x 850 mm.

Weight: 25 kg.

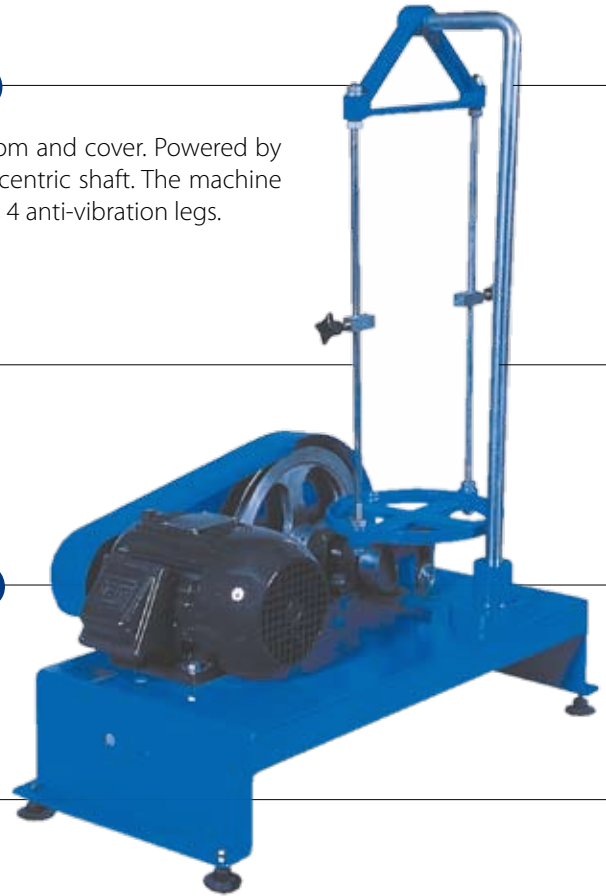

A0506 Rocking sieve shaker

Similar to the model above, this model holds up to 6 sieves measuring \varnothing 8" or 12" or \varnothing 200 or 300 mm plus bottom and cover.

Power supply: 220 V. 50/60 Hz.

Dimensions: 1070 x 760 x 460 mm.

Weight: 58 kg.

A0509 Laboratory vibrosieve shaker

This model has been designed specifically for tests "in situ" tests or in civil engineering laboratories. Powered by an electric motor, it can sieve up to 10 sieves measuring \varnothing 8" or 200 mm plus bottom and cover. Equipped with a 0 - 60 min programmable timer, a power meter to adjust the vibration speed and a main on/off switch.

Power supply: 220 V. 50/60 Hz.

Dimensions: 990 x 600 x 550 mm.

Weight: 35 kg.

A0511 Laboratory vibrosieve shaker

This model has been designed specifically for tests "in situ" tests or in civil engineering laboratories. Powered by an electric motor, it can sieve up to 8 sieves measuring \varnothing 8" or 200 mm, 250 mm, 12" or 300 mm and 315 mm plus bottom and cover. It can also be used for wet sieve tests.

Power supply: 220-240 V. 50/60 Hz. Single phase. 110 W

Dimensions: 950 x 400 x 350 mm.

Weight: 24 kg.



Standards UNE 933, -1

A0508 Electromagnetic sieve shaker

Powered by electromagnetic pulses. This model is specially recommended for sieve tests requiring greater levels of accuracy. This simple yet robust sieve shaker can also be used in wet sieve tests. The electronic control panel, provided separately, allows you to programme sieving times (1-999 minutes), vibration intensity and pauses between vibrations (especially indicated for sieving fine materials). The sieve shaker has capacity for up to 10 sieves measuring Ø 200-250-300-315 mm, 8" - 12", plus bottom and cover.

Power supply: 220 V. 50/60 Hz.

Dimensions: 380 x 440 x 1080 mm.

Weight: 65 kg.

Power: 750 W.



A0510 Electromagnetic sieve shaker

Similar to the previous models but with capacity for sieves measuring Ø 200 and 8" plus bottom and cover.

Power supply: 220 V. 50/60 Hz.

Dimensions: 320 x 385 x 850 mm.

Weight: 42 kg.



A0507 Electromagnetic sieve shaker

Similar to the model above, this model has capacity for sieves measuring Ø 200 -250-300-315-400-450 mm, 8" - 12" - 18", plus bottom and cover.

Power supply: 220 V. 50/60 Hz.

Dimensions: 480 x 500 x 1150 mm.

Weight: 85 kg.



Sieving machines

Standards UNE 933-10

A0504 Air jet sieving machine

This sieving machine is used for dry sieving products in the form of dust or granules. It is used to obtain granulometric curves of between 5 and 4000 microns. The operating principle is based on the use of an air jet that drags the fine particles through a sieve. This is achieved by a vacuum cleaner that generates a controlled low pressure through the vacuum cleaner connection outlet. Other accessories can be placed on the device, such as a cyclone to recover the material dragged by the air flow.

Size range 5 to 10 to 4000 microns.

Vacuum adjuster.

ON-OFF switch.

Integrated electronic control with the following functions:

Digital vacuum indicator from 0 – 99 mbar.

Vacuum meter calibration function.

0 - 99 minute programming.

Stop, start and pause modes.

Polished AISI 304 stainless steel interior.

Motor, 20 r.p.m. 14.7 W (220 V, 50/60 Hz).

IP 52.

Complies with EC directives (89/392/EEC), (91/368 CEE) (98/37 CEE), (98/44 CEE).

Weight 20 kg.

Vacuum cleaner available - 1200 W and 2400 W (220 V, 50/60 Hz).

Vacuum up to 65 mba.

This sieving machine is used in nearly all industrial sectors that process powdered products. The reliability and repeatability of results makes this equipment essential in powdered product quality control processes. The simplicity and extraordinary performance of this sieving machine make it essential for any quality control laboratory.

The unit consists of:

Sieving machine.

Connection cable.

Plexiglass cover.

Small plastic hammer.

Vacuum cleaner and connection tube.

Instructions manual.

Accessories

A0504/1 Vacuum cleaner.

A0504/2 Sieve with 0.0020 mm mesh size.

A0504/3 Sieve with 0.032 mm mesh size.

A0504/4 Sieve with 0.036 mm mesh size.

A0504/5 Sieve with 0.038 mm mesh size.

A0504/6 Sieve with 0.040 mm mesh size.

A0504/7 Sieve with 0.063 mm mesh size.



A0512 Soundproof cabin

For sieve shakers A0507 – A0508 – A0509 and A0511. Internally coated with insulating material to reduce noise levels in compliance with EC directives.



Standards ASTM E11



A0515 Large-capacity sieve shaker

Designed for test sample classification of flat rocks, sand, gravel, coal, slag, minerals and similar materials. Capacity for up to six sieves and a receiver bottom. Each sieve can hold almost 30 kg of material. The device is supplied without the sieves, which must be order separately, specifying mesh size. (See table with mesh sizes and please consult for other sizes).

Power supply: 220 V. 50/60 Hz.

Dimensions: 570 x 760 x 1200 mm

Weight: 170 kg

Reference	Opening	Reference	Opening	Reference	Opening
A0515/1	4"	A0515/10	3/8"	A0515/19	No. 30
A0515/2	3 1/2"	A0515/11	7/16"	A0515/20	No. 40
A0515/3	3"	A0515/12	5/16"	A0515/21	No. 50
A0515/4	2 1/2"	A0515/13	1/4"	A0515/22	No. 60
A0515/5	2"	A0515/14	No. 4	A0515/23	No. 80
A0515/6	1 1/2"	A0515/15	No. 8	A0515/24	No. 100
A0515/7	1"	A0515/16	No. 10	A0515/25	No. 140
A0515/8	3/4"	A0515/17	No. 16	A0515/26	No. 200
A0515/9	1/2"	A0515/18	No. 20	A0515/27	Bottom

Accessories:

A0516 Soundproof cabin for large-capacity sieve shaker machine.

Flakiness index and particle shape

Standards BS 812

Determining flakiness index

A set of seven rectangular sieves made of painted sheet metal with calibrated slots, sizes are shown in the table below:



Reference	Slot width	Slot length	Dimensions
A0520	4.9	30	290 x 237 x 75
A0521	7.2	40	305 x 248 x 75
A0522	10.2	50	330 x 257 x 75
A0523	14.4	60	358 x 271 x 75
A0524	19.7	80	391 x 283 x 75
A0525	26.3	90	424 x 293 x 75
A0526	33.9	100	467 x 305 x 75

Standards EN 933, -3; NF P18-561

Determining particle shape

A set comprising a series of 13 sieves measuring 30 x 30 cm with bars from Ø 5 mm to 15 mm separated as shown in table below:

Reference	Slot width	Reference	Slot width
A0530	2.5 mm	A0537	12.5 mm
A0531	3.15 mm	A0538	16.0 mm
A0532	4.0 mm	A0539	20.0 mm
A0533	5.0 mm	A0540	25.0 mm
A0534	6.3 mm	A0541	31.5 mm
A0535	8.0 mm	A0542	40.0 mm
A0536	10.0 mm	A0543	Bottom



Tests to determine the geometric properties of aggregates. Flow assessment

Standards EN 933-6

Determining flakiness index

A0518 Vibrating table and flow unit to determine the mechanical and geometrical properties of any type of aggregate. This unit consists of a vibrating tray with spirit level, four rubber springs, a 10 kg base plate and an unbalanced weight vibrator. The equipment also includes a flow unit with a total mass of 42.3 ± 0.1 kg with a metal trough, plug, mobile metal skirt to release material flow and a plastic tube with internal $\varnothing 125 + 2 \times 610 + 10$ mm.

Characteristics:

Rotation speed: 2970 ± 20 r.p.m.

Vibration frequency: 50Hz.

Vibrating amplitude with empty flow unit: 0.18 ± 0.02 mm.

Power supply: 3 x 380 V. 50/Hz.

Base plate dimensions: 400 x 400 x 500 mm.

Total dimensions: 400 x 520 x 1200 mm.

Weight: 170 kg approx.



Determining clay, silt and dust content in aggregates

Standards ASTM C 117; BS 812

Testing for materials finer than 75 μ m

Gravimetric system used to determine the clay, silt, and dust content of a portion of material finer than 75 μ m.

A0545 Bottle stirrer, fixed speed of 80 rpm.

V1005 1l capacity flask with lid.

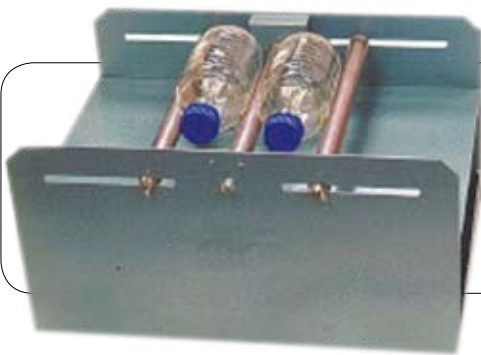

Standards EN 933-9; NF P94-068; NF P18-592

Methylene blue test

This test is used to measure the methylene blue absorption capacity of sand fines. Methylene blue test equipment, consisting of:

A0550 Electronic paddle stirrer with digital reading. Supplied complete with stirring paddle, support and fixing chuck. Speed adjustable between 400-700 rpm.

V7552 Burette, with 50 ml glass stopcock.

A0552 Box of filter paper, $\varnothing 125$ mm.

A0553 300 mm glass rod.

V6806 Beaker, 600 ml.

A0555 Methylene blue (25 g box).

V0190 Base plate support measuring 190 x 135 mm. Rod measuring $\varnothing 9 \times 500$ mm.

V0265 Double straight chuck.

V0266 Burette clamp.



Apparent and relative density. Absorption and specific weight

The results obtained for the relative density of aggregates depends on the test method used. It is advisable to conduct a study on the aggregates themselves, choosing the type of test based on the resulting aggregate after comparison.

Standards EN 1097-6; UNE 7140, 7083, 83.133; ASTM C128, C127; AASHTO T84; BS 812; NLT 154; DIN 12039

Determining particle density and water absorption

V6363 500 ml calibrated flask.

A0560 Set consisting of a tapered mold, funnel and tamper to determine the absorption of fine aggregate.

A0561 500 ml pycnometer with plug, capillary tube and funnel.

A0561/1 1000 ml pycnometer with plug, capillary tube and funnel.



Standards EN 1097-7; NF P18-558; BS 812; NLT 155

Filler relative density test

A0562 1000 ml pycnometer to determine the specific weight of sand and fine aggregates. Consisting of a glass bottle with an aluminium cone.

A0563 1000 ml pycnometer with notches on the side to ensure the cover is securely fitted.

A0564 2000 ml pycnometer with notches on the side to ensure the cover is securely fitted.



Standards UNE 1097-6; NLT 153/92

Coarse aggregate relative density test

A0565 Metal basket measuring \varnothing 20 x 20 cm with handle to test coarse aggregate sizes of less than 38 mm.

A0566 Metal basket measuring \varnothing 25 x 25 cm with handle to test coarse aggregate sizes above 38 mm.

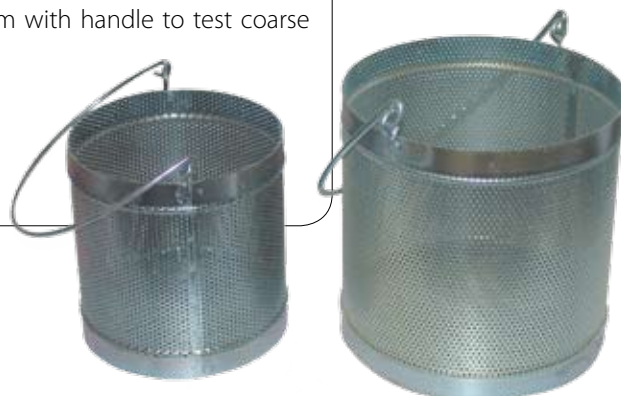



Standards BS 812

Coarse aggregate density using the water displacement

A0570 This device uses the water displacement method to measure the density of coarse aggregate and consists of a cylindrical metal container measuring \varnothing 150 mm x 350 mm high and a siphoning tube at 250 mm from the base.

Weight: 3 kg

A0570/1 250 ml calibrated test tube.

Standards EN 1097-3; NLT 156; ASTM C29; BS 812

Apparent density of aggregates

A0576 20 dm³ metal container complete with handles.

A0577 10 dm³ metal container complete with handles.

A0578 5 dm³ metal container complete with handles.

A0579 1 dm³ metal container complete with handles.

H0002 Steel rod measuring \varnothing 16 x 600 mm.



Standards BS 812

Determining moisture content

A0580 Siphon can unit for determining the relative moisture content in known conditions. Consisting of a measuring cylinder with 500 ml capacity, stirring rod, rubber tubes and clamps.

Weight: 3.5 kg



Standards UNE 103.302; ASTM 854; ASTHO T100; BS 1377:2

Specific weight of aggregates

V6361 100 cc calibrated flask with polyethylene stop.

V5562 Bevelled pycnometer with 50 cc capacity.

V5572 Flared pycnometer with 50 cc capacity.





Standards EN 1097-4; NLT 177; BS 812

Determination of voids in filler

A0590 Device for compacting filler, consisting of a base measuring 100 x 150 mm with two guiding columns, a cylinder with internal \varnothing 25 mm and a graduated puncher that slides freely on the cylinder without side scraping.

Weight: 4 kg.

Accessories

A0590/1 Impact counter to fasten to the device.

A0590/2 Pack of 100 25 mm filters.

Standards ASTM C70; AASHTO T142

Surface moisture of fine aggregate

A0597 Chapman flask to determine surface moisture in fine aggregate. The flask is graduated to 200 ml between two bulbs and from 375 to 450 ml above the second bulb.

Weight: 500 g.



Standards EN 1367-4; BS 812:102

Determination of drying shrinkage

A0607 Triple mold measuring 50x50x200 mm, with contact points for shrinkage tests.

A0607/1 Pack of 12 mold contact points.

A0607/2 Reference bar for calibration.

C0037 Linear variation meter (see cements section).



Standards NLT 354; BS 812

Flakiness and elongation index of road aggregates



The size aggregates used for a flexible surface is defined by the percentage of flat and elongated particles measuring between 63 and 6.3 mm.

A0600 Slotted gauge to measure the flakiness index of the aggregate. Made of galvanised sheet metal.

Weight: 700 g.

A0601 Bar gauge to determine the elongation index of the aggregate.

Weight: 1.5 kg.



Shape coefficient

Standards EN 933-4

A0605 Gauge to determine the shape coefficient of the aggregate. Made of galvanised sheet metal with modified notches.

Weight: 500 g.



Standards EN 933-4; DIN 4226; CNR 95

A0606 Vernier calliper for aggregates. Calliper to determine the shape factor of aggregates for concrete.

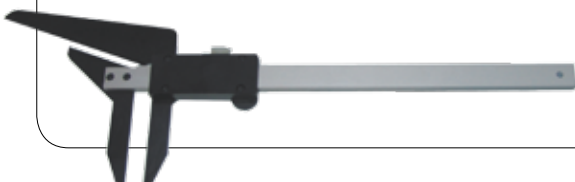

Potential alkali reactivity of cement aggregates

Standards EN 96; UNE 146.507, 146.507-1; ASTM C289

Test to determine potential chemical reaction of aggregates on contact with cement alkalis.

A0610 Reactivity container

Made of stainless steel with an airtight lid.

Capacity: 59 cm³.



Carbonate content of aggregates

Standards UNE 103.200: NLT 116

A0615 Bernard calcimeter

Made of metal and used to determine the carbonate content of aggregates and soils. When hydrochloric acid is added to the sample, the carbonate in the sample is released in the form of CO₂. Consequently, the release CO increases the pressure, which in turn increases the water level in the deaeration burette.

The difference in the levels measured indicates the amount of CO₂ that has been released, thus allowing the carbonate content to be calculated. The unit consists of a support, a burette with capacity for 100 cm³, a level tube with a tank measuring Ø 40 x 140 mm long, an Erlenmeyer flask of 250 cm³ with a rubber stop pierced by a glass tube, a glass tube with 3 cm³ capacity and a flexible rubber tube.

Approx. weight: 12 kg.

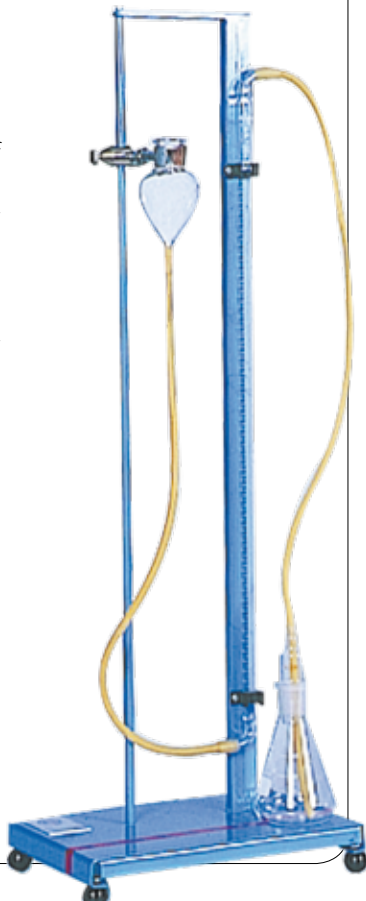

A0616 Dietrich - Frühling calcimeter

For determining CaCO₃, particularly in lime samples. The equipment consists of a glass container where the reaction takes place between the calcium carbonate contained in the aggregate and the diluted hydrochloric acid. The gas that is generated is collected and measured in a special device connected to the container. Therefore, the volume of gas released indicates the amount of CaCO₃ contained in the sample.

Approx. weight: 12 kg.



Aggregate consistency

Standards EN 1367-2; NLT 158; ASTM C86

Baskets and accessories

The perforated nickel plated brass baskets and the brass mesh bucket are used to hold aggregate samples in order to study their ability to withstand frost.

A0621 Brass bucket and mesh.

A0624 Bucket 160 x 120 mm Ø, mesh size 3.35 mm.

A0624/1 Bucket 120 x 95 mm Ø, mesh size 1.18 mm.

A0624/2 Bucket 120 x 95 mm Ø, mesh size 0.60 mm.

A0624/3 Bucket 80 x 65 mm Ø, mesh size 0.15 mm.

A0624/4 Bucket 120 x 95 mm Ø, mesh size 0.50 mm.

V0966 Density meter.

A0622 Brass bucket with handle and 0.6 l capacity.

A0623 Brass bucket with handle and 1.8 l capacity.



Abrasion test

Standards EN 1097-2; NLT 325; ASTM C131, C535; AASHTO T 96; NF18-573

A0625 Los Angeles machine

To determine the abrasion resistance of aggregates. The machine consists of a steel cylinder 12 ± 0.5 mm thick with an internal Ø of 711 x 508 ± 1 mm internal length with horizontal rotation shaft. The cylinder rotates at 30-33 rpm. The motor and the cylinder are mounted on a firm steel base. The control panel consists of the on-off switches and the automatic turn counter with digital display. Supplied complete with a set of 12 abrasive balls and a sample tray.

Power: 1 hp.

Power supply: 220/380 V. 50 Hz.

Dimensions: 1120 x 860 x 820 mm.

Weight: 350 kg.

Accessories

A0625/1 Set of 12 abrasive balls, in compliance with EN 1097-2 NF P 18-573.

A0625/2 Set of 12 abrasive balls, in compliance with UNE 83116; ASTM C131; ASSHTO T96; NLT 325; CNR No.34.

A0625/4 Soundproof cabin.

In compliance with 89/392 CEE.



Mechanical properties

Crushing resistance

Standards UNE 83112; BS

This test determines the crushing resistance of aggregates subjected to a load or compression applied gradually. The equipment can be supplied in two different sizes depending on the aggregate requiring study.

A0630 Standard equipment to determine the crushing resistance of aggregates measuring more than 9.5 mm. Supplied complete with a cylindrical mold measuring \varnothing 150 mm, piston, base plate, compaction rod and measuring cylinder.

A0631 Equipment to determine the crushing resistance of aggregates measuring less than 9.5 mm. Supplied complete with a cylindrical mold measuring \varnothing 75 mm, piston, base plate, compaction rod and measuring cylinder.



Standards UNE 7134; ASTM C235

Aggregate consistency

A0640 Sclerometer to determine soft particles contained in coarse aggregates. Consisting of a \varnothing 1.6 mm needle with a round head mounted on a moving cylinder weighing 1 kg with free fall.

Weight: 63 kg.

Standards BS 812; NF P18-574

Impact resistance

A0635 A device to test the impact resistance of aggregates in compliance with BS 812, of robust steel build, protected against corrosion and equipped with an automatic impact counter. Supplied complete with a cylinder measuring \varnothing 76 x 52 mm deep and a compaction rod measuring \varnothing 9.5 x 300 mm long.

Dimensions: 440 x 320 x 930 mm.

Approx. weight: 55 kg.

Accessories and spare parts:

A0635/1 Cylinder measuring \varnothing 76 x 52 mm.

A0635/2 Compaction rod measuring \varnothing 9.5 x 300 mm.

A0636 A device to test the impact resistance of aggregates in compliance with NF P 18-574, of robust steel build, protected against corrosion and equipped with an automatic impact counter. Supplied complete with a cylinder measuring \varnothing 102 x 52 mm deep and a compaction rod measuring \varnothing 9.5 x 300 mm long.

Dimensions: 440 x 320 x 930 mm.

Approx. weight: 55 kg.

Accessories and spare parts:

A0636/1 Cylinder measuring \varnothing 102 x 52 mm in compliance with NF P 18-574.

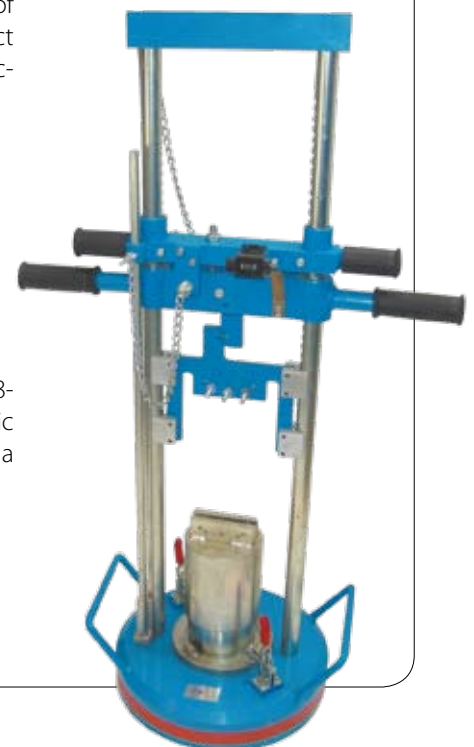

Abrasive wear resistance test

Standards UNE 127.005

Wear resistance

The purpose of this test is to determine the wear of the tested material under certain conditions. A specimen of a known size rotates around a shaft passing through the centre, whilst also being pressed by a predetermined weight on a flat circular crown that rotates on its own shaft and whilst water and the abrasive element are released from dosers on the rotating crown.

A0645 Tribometer to determine the wear resistance of marble, cement tiles and similar materials. The machine is supplied with an automatic counter and power meter for regulation of the wear elements. Speed: 30 rpm.

Specific specimen load: 0.06 N/mm².

Power supply: 220/380 V. 50 Hz.

Dimensions: 1100 x 900 x 1300 mm.

Weight: 550 kg.

Spares

A0645/1 Abrasive material (5 kg).



Standards EN 1341, 1342,1343; Standards UNE 1339, 10545-6; UNE 13748-2

Wear resistance

A0650 Abrasion machine to determine the wear resistance of cement tiles. An electro-mechanically driven machine with a Ø 200 mm disc 70 ± 0.1 mm thick. The pressure of the disk on the specimen is generated by a 14 kg counterbalance. A dosing hopper with a capacity for 10 l of abrasive material is mounted on an adjustable support. The control module includes an automatic meter with rpm selection control, an indication light and emergency stop button. The machine is completely closed to prevent dust escaping and to minimise noise. It is equipped with a safety system that stops the machine automatically if the doors are opened. Manufactured in compliance with EC safety requirements.

Test speed: 75 rpm.

Abrasive outlet: 3 l/min (adjustable).

Power supply: 220/380 V. 50 Hz.

Dimensions: 800 x 1360 x 1700 mm.

Weight: 300 kg.

Accessories:

A0650/1 Spare disk.

A0650/2 Abrasive (25 kg sack).

A0650/3 Marble specimen, 150 x 150 x 50 mm thick.





Standards EN 1097-8; UNE EN 1342; ASTM C131, C535; BS 812-3 A0651 Dorry Machine

To determine the resistance of aggregates to surface wear. This device consists of a round surface of \varnothing 600 mm that rotates horizontally while a funnel continuously discharges a jet of sand on the surface, in front of each specimen. After passing under the specimens, the material is separated and collected. The machine is supplied complete with two specimen molds, two collection trays, two plates, weights and adjustments hooks.

Power supply: 220/380 V. 50 Hz.

Dimensions: 650 x 800 1000 mm.

Weight: 200 kg.

A0651/1 Dorry set of two molds.

A0651/2 Abrasive sand, 25 kg sack.

Standards UNE EN ISO 10545-7/1996

A0653 Abrasion meter

A measuring instrument to determine the abrasion resistance of glazed ceramic in compliance with standard ISO 10545; EN 102.

Characteristics:

Fully automatic operating cycle.
Electrical operation.
Three test stations.
Pre-selectable automatic turn interruption.
Tough, robust equipment.
Wet (PEI) or dry (MCC) abrasion loads.

The equipment includes:

700 g of steel balls with \varnothing 5 mm.
52.5 g of steel balls with \varnothing 3 mm.
43.75 g of steel balls with \varnothing 2 mm.
8.75 g of steel balls with \varnothing 1 mm.
30 g of aluminium oxide, grain size 80 (FEPA).
20 ml of deionised or distilled water.



Standards UNE EN ISO 10545-2

Masonry materials. Determination of dimensions and surface quality.

A0652/2 Warpage tester. Analogue or digital system for specimens from 100 x 100 mm to 650 x 650 mm, supplied with six analogue or digital gauges with 10 mm stroke x 0.01 mm accuracy.

Options

A0652/1 Calibrated model plate measuring 300 x 300 mm.

A0652/2 Calibrated model plate measuring 400 x 400 mm.

V0016 Analogue gauge 10 mm x 0.01 mm.

V0024 Digital gauge 10 mm x 0.001 mm.

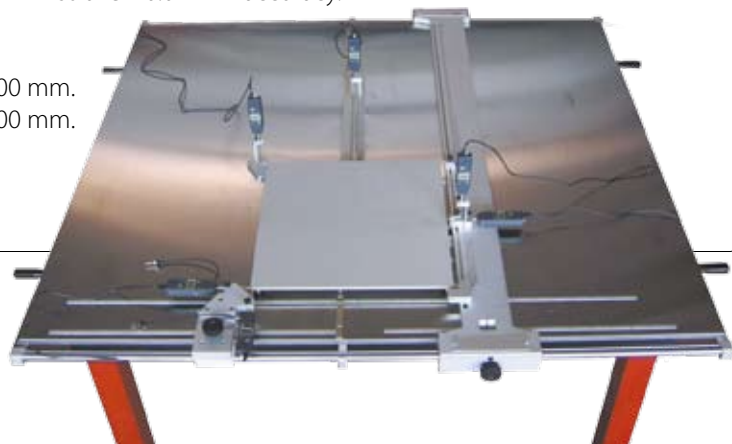

Friability coefficient. Fragmentation resistance

Standards EN 1097-1; UNE 83.115; AFNOR P18.572; NF P18-576

A0655 Micro-deval machine

The machine consists of a robust iron frame in which four test cylinders measuring \varnothing int. 200 \pm 1 mm x 154 \pm 1 mm high rotate at constant speed on two metal rollers covered with anti-wear rubber. Each cylinder has an hermetically sealed lid to guarantee airtightness. The digital command and control panel is vibration free and includes electronic adjustment, selection and automatic end-of-cycle stop technology. The machine is supplied complete with safety protection and emergency stop in compliance with EC machine directives, with a collection tray. Abrasion balls are not included and must be ordered separately (see accessories).

Rotation speed: 100 \pm 5 rpm.

Power supply: 220/380 V. 50 Hz.

Dimensions: 1120 x 1240 x 520 mm.

Weight: 110 kg.

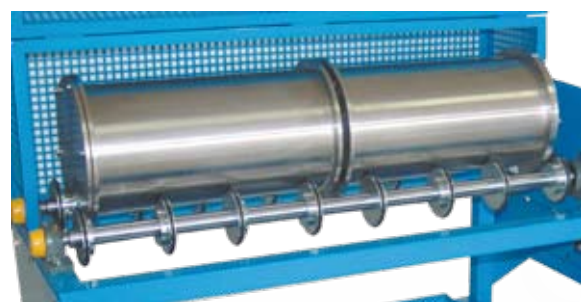
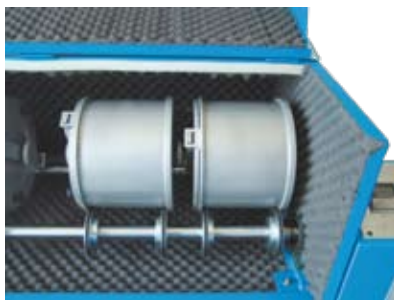

Accessories:

A0655/1 Steel balls of 10 mm diameter. 25 kg pack.

A0655/1/2 Steel balls of 18 mm diameter. 50 unit pack. Fulfils standard NF P18-576.

A0655/1/3 Steel balls of 30 mm diameter. 10 unit pack. Fulfils standard NF P18-576.

A0655/2 Standard spare cylinder. Stainless steel.

A0655/3 Stainless steel cylinder of 200 mm diameter x 400 mm long. Complies with NF P18-576.

A0655/4 Soundproof protection system.

A0655/5 Non-soundproof protection system.

Standards NF P18-577

A0656 Deval machine

Machine designed to test the abrasion resistance of aggregates subjected to friction and impacts. It consists of a frame that rotates at 30-33 rpm, supporting two cylinders at an angle of 30° from the rotation axis. The digital command and control panel is vibration free and includes electronic adjustment, selection and automatic end-of-cycle stop technology. The machine is supplied complete with collection trays.

Power supply: 220/380 V. 50 Hz.

Dimensions: 1450 x 650 x 900 mm.

Weight: 180 kg.

Accessories:

A0656/2 Soundproof cabin with microswitch.



Accelerated aggregate polishing

Standards EN 1097-8; NLT 174; BS 812:114; NF P18-575; ASTM E303

The wear value of an aggregate provides a measurement of resistance to the wear produced by the tyres of a vehicle in similar conditions to those that occur on a road surface. Vehicle tyres passing over a road surface causes wear to the aggregate, this wear condition is one of the main factors that affect skid strength. The actual relationship between PSV and skid resistance will vary

depending on the traffic conditions, the type of surface and other factors. The PSV test is performed in two stages. The accelerated sample polishing test, followed by wear measurement with the friction test.

A0660 Machine to determine the accelerated polishing coefficient (A.P.C.)

The machine consists of a wheel that turns at 320 rpm. There are 14 sample holders on the perimeter of the wheel. A solid rubber wheel is housed in a vertical position on the top part of the wheel, bearing on it with a force of 725 N. Two containers feed the abrasive material and water. The first container holds grain abrasive mixed with water and the second one holds powdered abrasive also mixed with water.

Both spill the material on the place where both wheels meet. The machine is supplied complete with the wheel, a side plate, rubber rings, rubber tyre, transmission belt, abrasive material feeder, grain abrasive, powdered abrasive, tool set, set of 4 sample holder molds and two mold bases.

Tyre speed: 315 to 325 rpm.

Power supply: 220/380 V. 50 Hz.

Dimensions: 1520 x 720 x 740 mm.

Weight: 175 kg.

Accessories and spare parts:

A0660/1 Grain abrasive (25 kg).

A0660/2 Powder abrasive (25 kg).

A0660/3 Control stone (25 kg).

A0660/4 Rubber tyre.

A0660/5 Spare mold.

A0660/6 Mold base.

A0660/7 Rubber ring.



Skid resistance coefficient

Standards EN 1097-8; EN 13036-4; NLT 175; ASTM E303; BS 812:114; NF P15-578

This test was developed by the Road Research Laboratory of Great Britain, an organisation dedicated to studying problems relating to the design, construction, maintenance and use of highways. The machine consists of an adjustable pendular arm

and a spring-loaded rubber footing mounted on the end of the arm. The base has three adjustable legs and a spirit level to level the pendulum.

A0661 TRRL Pendulum skid resistance tester

Complete with 6 rubber footings for "in situ" testing, thermometer, graduated perspex scale, two spanners, water bottle, folding chair with instrument tray, transparent plastic cover, portable case and instruction manual. The device is calibrated using a "Criggion" stone, characterised as being an exceptionally consistent material.

Dimensions: 790 x 650 x 230 mm.

Dimensions with box: 830 x 750 x 350 mm.

Weight: 32 kg.

Spare parts:

A0661/1 Base plate.

A0661/2 Spare rubber element for PSV test.

A0661/3 Spare rubber element for in situ test.

A0661/5 Large rubber footing (6).

A0661/6 Small rubber footing (6).



Rock samples

A0668 Polishing machine

For preparing rock, mineral, ceramic or metalographic samples. Equipped with a \varnothing 250 mm disc that rotates at various speeds, 200 and 400 rpm, depending on the material to be polished.

Power supply: 220 V. / 50 Hz.

Dimensions: 430 x 370 x 640 mm.

Weight: 30 kg.

Accessories:

A0668/1 Diamond paste for polishing (10 g), 3 micron.

A0668/2 Adhesive polishing cloth \varnothing 250 mm.

A0668/3 Lubrication oil 1l.

A0668/4 Pack of 100 non-adhesive sanding discs measuring \varnothing 250 mm (800 grain).



Standards UNE 1744-1

Jaw Crusher

A0670 Jaw crusher. A machine used in laboratories to crush samples of aggregate, minerals and similar materials in order to reduce their size. The crusher has an input opening measuring 80 x 50 mm, and the size of the crushed material can be set to as little as 1 mm. Production capacity, depending on the material to crush, is 5 dm³/h.

Container capacity: 2.5 dm³.

Power supply: 220 V. / 50 Hz.

Dimensions: 800 x 300 x 600 mm.

Weight: 106 kg.

Accessories:

A0670/1 Set of jaws.

A0670CE Jaw Crusher. This machine is identical to the one above but is equipped with a safety system (noise / trapping) in compliance with the EC directive.



Standards UNE 83120

A0722 Large capacity jaw crusher

Large capacity equipment for crushing ballast featuring following technical characteristics:

Input dimensions: 600 x 300 mm.

Output opening: adjustable between 1 and 90 mm.

Production per hour: 35 TM/h.

Motor power: 30 CV.

Weight: 4,000 kg.

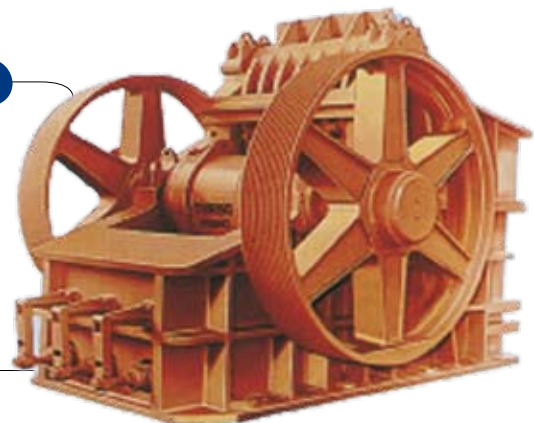

A0671 Culatti micro-whisk mill

This small mill works on the hammer mill principle and was designed specifically for cases where the milling of small amounts of substances in different grain sizes is required. Using this device eliminates practically all material losses, since the milling chamber becomes airtight when closed. The device is supplied with three sieves with mesh sizes of 1, 2 and 3 mm.

Technical characteristics

Electronic speed adjustment: 0 to 5000 rpm.

Hopper capacity: 120 c.c. approx.

Collection tube capacity: 35 c.c.

Maximum sample size: 6 mm.

Airtight milling chamber.

Approx. milling time: 30 to 120 sec.

Power supply AC: 220/50 Hz – 200 W.

Accessories:

A0671/4 Sieve mesh size 1 mm.

A0671/6 Sieve mesh size 2 mm.

A0671/7 Sieve mesh size 3 mm.

A0671/8 Sieve mesh size 4 mm.

A0671/9 Sieve mesh size 5 mm.

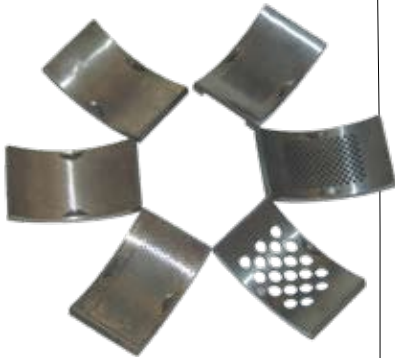

Rock durability

This method was designed to determine rock deterioration while subjected to wear by water.

Standards NLT - 251; ASTM D 4644

A0675 Slake durability tester

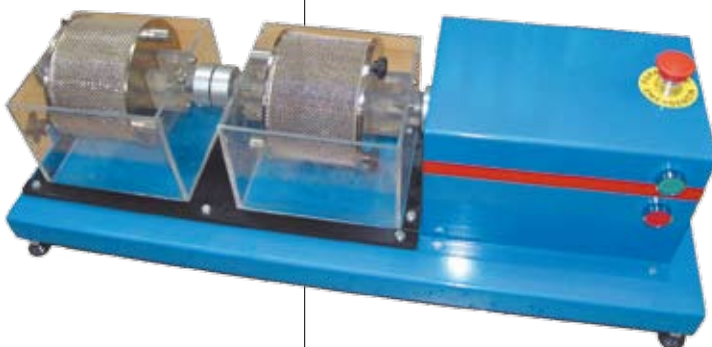

This consists of a base-mounted motor that rotates two stainless steel drums measuring $\varnothing 140 \times 100$ mm long with a mesh size of 2 mm at 20 rpm. The drums are submerged into 20 mm of water inside two tanks made of plexiglass.

Power supply: 220 V. / 50 Hz.

Dimensions: 830 x 290 x 300 mm.

Weight: 35 kg.

Accessories:

A0675/1 Stainless steel drum measuring $\varnothing 140 \times 100$ mm.

Rock strength index

Standards NLT - 252; ASTM D5731



Standards UNE 1744-1

Digital point load unit

A0678 Digital point load unit, developed based on a prototype created at the Imperial College of London. The apparatus consists of a rigid chassis supporting a test frame consisting of two columns with an adjustable connecting bridge at the top, a hydraulic piston activated by a manual pump, a millimetre rule to measure the distance between two cone-shaped points made of special steel, a pressure sensor and a digital display with a microprocessor. The H0206/1 display is mounted on an adjustable vertical shaft

Dimensions: 406 x 150 x 170 mm.

Weight: 16 kg.

A0679 Point load unit consisting of a rigid chassis supporting a test frame made up of two columns with an adjustable connecting bridge at the top, a hydraulic piston activated by a manual pump, a millimetre rule to measure the distance between two cone-shaped points made of special steel, and a digital pressure gauge.

Dimensions: 406 x 150 x 170 mm.

Weight: 16 kg.

A0680 This machine is identical to the one above but includes a pressure gauge graduated to 400 kg/cm².

Accessories:

A0680/1 Pressure gauge up to 400 kg/cm².

A0680/2 Pressure gauge up to 100 kg/cm².

A0680/3 Pressure gauge up to 20 kg/cm².

A0680/4 Set of cone-shaped points.

A0680/5 Safety system in compliance with EC directive.

A0680/6 Protection mask.



Sample cutter

H0150 Sample cutter

A cutter adapted for cutting rocks and construction elements. It includes a device for cutting specimens obtained by core barrels as well as irregular rock specimens. Supplied with disc protection and a submergible pump for water recirculation and cooling.

Power: 3 hp.

Motor: 220v-50hz.

Disc Ø in millimetres: 330 / 350 – 25.4.

Cutting length: 600 mm.

Accessories:

H0154 Cutting disc Ø 300 x 25.4 mm.

H0155 Cutting disc Ø 350 x 25.4 mm.



Tilt test

A0750 Apparatus to determine the roughness coefficient

The equipment consists of an adjustable tilted plane where the rock sample is placed. The test is carried out by slowly tilting the plane until the rock slides. The roughness index is calculated from the sliding angle.

Tilting angle: 0 – 50°

Total dimensions: 270 x 175 x 265 mm.

Weight: 5 kg.



H0394 Ultrasound equipment

Portable ultrasound equipment with the following characteristics:

Measuring range: 0-9999.9 μ s.

Resolution: 0.1 μ s.

Accuracy: + 0.1 μ s.

Display of distance between probes.

Propagation speed measurement m/s.

Memory capacity: up to 50 readings.

Data output: RS232C (Windows hyperterminal).

Outputs: TRG and OUT for viewing on an oscilloscope.

Autonomy: 12 hours with 2300mAh batteries.

Screen: Feedback LCD with two lines (operation in low light conditions).

Supplied with:

Portable case.

Two 150 kHz probes.

Two 150 cm connection cables.

Reference block.

Coupling paste.

Pack of rechargeable batteries.

Battery charger.

RS232C cable.



Rock mechanics

Standards D3148, D2938, D5407, D2664

Determining the elasticity modulus, Poisson coefficient and shear modulus

The single axis test is carried out by applying an increasing load at a constant pressure speed of between 0.5 and 1.0 MPa/s. Axis and diameter deformation must be measured with great precision (approx. 5×10^{-6}). Afterwards, loading and unloading cycles are applied to determine compressibility properties. These tests require the use of a servo power system. The system should be servo-controlled and not simulated, since the tests require application of very precise loads during very precise time periods. The machine is controlled by the software installed. The software

was developed by our own IT department. Programming, in a Labview environment, enables the machine to be controlled via the National Instruments card (installed in the PC). The card, the software and the servo-control provide precise test control, to ensure gradients are controlled during both loading and unloading processes. The system captures up to 100,000 data per second. As a result, the applied force is controlled very effectively and real test result graphs can be obtained. In turn, the 16-channel card allows the user to add new transducers to the machine for new

tests, such as elasticity modulus calculations, Poisson coefficient, etc. The machine's control facilitates dynamic tests. For example, the application of a load during a period of time without breaking the specimen, reducing the load and maintaining the time period, applying a second load (equal to or greater than the first load) and so on while programming as many loading and unloading cycles as desired.

Single axis tests with extensometric bands

The purpose of the test is to establish a method to determine stress-deformation curves, elasticity module (Young) and Poisson coefficient in single axis compression of a regular cylindrical specimen. The extensometric bands must be previously installed on the specimen to be tested. The orientation and position of the bands is very important because they will condition the results of the test. The extensometric bands must be chosen according to the grain size of the rock to be tested. Four bands should be placed on each specimen, two for axial deformation and two for diametral deformation. To obtain optimal results, each band should be installed in a complete Wheatstone bridge. Data is collected by a computer, although it is first passed through a signal conditioner. The software performs the process automatically, starting the test, controlling the cycles, collecting data, etc. The data can be viewed in real time while the test is being performed.



Equipment required

The system is exportable, i.e., these tests can be performed with other concrete presses other than those manufactured by PROETI.

2000 kN to 3000 kN press with computer control. The press has to be servo-controlled. Ideally, it would allow gradient control during loading and unloading (see concrete section). In many cases, electro-mechanical multipurpose testing machines can be used for these tests, depending on the rock section to be tested.

Extensometric bands.

Signal conditioner with capacity for 16 bands.

Compatible PC.

Data collection card.

Elasticity software.



H0235 3000 kN press.

S0373 Multipurpose testing machine for 300 kN.

H0561 Extensometric bands with 10 mm base length.

H0562 Extensometric bands with 20 mm base length.

H0563 Extensometric bands with 30 mm base length.

H0564 Extensometric bands with 60 mm base length.

H0560 Signal conditioner with capacity for 16 bands.

H0235PC Compatible PC.

H0240/1 Elasticity software.



Packs of extensometric bands come in sets of 10. It is very important to choose the correct band. It must be suitable for the rock type and rock grain size.

Single axis tests with LVDT sensors

The purpose of the test is to establish a method to determine stress-deformation curves, elasticity modulus (Young) and Poisson coefficient on the single axis compression of a regular cylindrical specimen. LVDT sensors are the best option when the nature of the rock does not allow for placement of extensometric bands. This occurs in very porous rocks, plastic rocks or rocks of a with very plastic behaviour. A compression gauge is required to position the LVDTs. Two LVDTs are positioned to measure diametral deformation and another two are placed to measure axial

deformation. Data is collected by computer, although the data from the LVDT first passes through a data collection box that carries out the analogue / digital conversion. The software performs the process automatically, starting the test, controlling the cycles, collecting data, etc. The data can be viewed in real time while the test is being performed.

The system is exportable, i.e., these tests can be performed with other concrete presses other than those manufactured by PROETI.

Equipment required

2000 kN to 3000 kN press with computer control. The press has to be servo-controlled. Ideally, it would allow gradient control during loading and unloading (see concrete section). In many cases, electro-mechanical multipurpose testing machines can be used for these tests, depending on the rock section to be tested.

LVDT sensors.

Data collection box with 16 channels.

Compatible PC.

Data collection card.

Elasticity software.

H0235 3000 kN press.

S0373 Multipurpose testing machine for 300 kN.

S0237 LVDT 2 mm sensor.

S0200 Data collection box.

H0253 Compression gauge/extensometer.

H0235PC Compatible PC.

H0235/2 Elasticity software.



Elasticity software

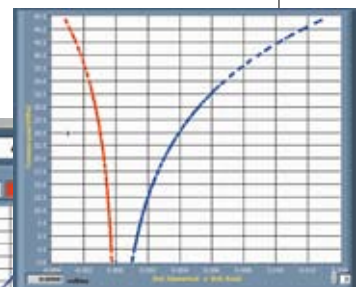
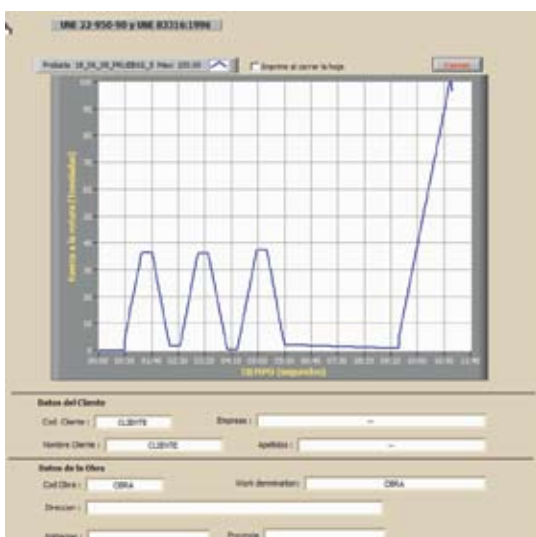
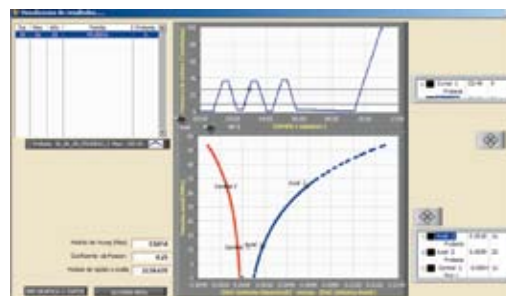
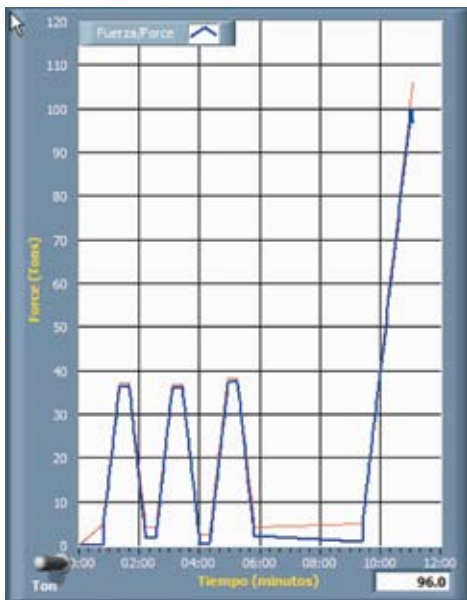

Devices for rocks

A0681 Device for indirect tensile strength in rock samples measuring \varnothing 90 mm.



A0682 Device for indirect tensile strength in rock samples measuring \varnothing 70 mm.



A0683 Niche type device for testing point loads in testing machines.

Standards ASTM D5607 – ISRM

A0685 Portable equipment for direct shear test on rocks

Designed to determine stability and skid resistance in rocks measuring a maximum of 115 x 125mm, or specimens of \varnothing 102 mm. The device consists of a shearing box with a diagonal section. The upper half has a vertical piston to apply load and the lower half has two horizontal pistons for reversible cutting action. The pressure is applied to the pistons by manually operated hydraulic pumps and the load is displayed on two Bourdon pressure gauges.

Maximum dimensions for irregular samples: 125 x 110 mm.

Maximum dimensions for cylindrical specimens: \varnothing 102 mm.

Horizontal displacement: gauge measuring 25 x 0.01 mm.

Dimensions: 600 x 250 x 460 mm.

Weight: 46 kg.

Accessories:

A0685/1 British Gypsum Crystacal plaster to prepare specimens, sack of 25 kg.

A0685/2 Mold to prepare sample.

A0685/3 Set of gauges (4) measuring 10 x 0.002 mm, complete with support in compliance with ASTM D5607.

A0685/4 Complete pressure stabiliser with pump to absorb sample volume changes and guarantee constant load during the test.



Rock classification

Standards ASTM D 5873

A0715 Sclerometer for rocks

Used for rock classification tests. The rock sample is placed horizontally on a special guide and the rebound index is obtained from the mean of several measurements taken perpendicularly to the longitudinal axis.

Weight: 2 kg.

Accessory:

A0715/1 Universal support-guide for testing any type of standard rock.

Weight: 10 kg.



V0043 Geologist's hammer

V0043 Geologist's pick hammer with hard plastic handle.

V0043/1 Geologist's chisel hammer with hard plastic handle.

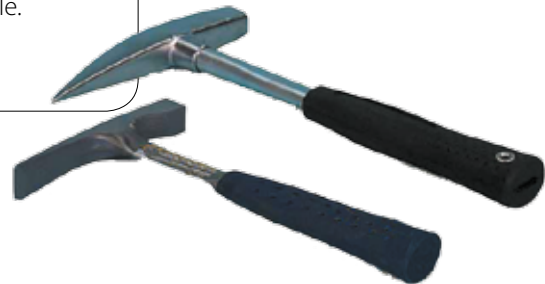

Standards EN 101

V0069 Set of minerals as per the Mohs hardness scale

Used to identify minerals according to surface hardness. The set consists of 10 reference minerals: 1 (Talcum) 2 (Plaster) 3 (Calcite) 4 (Fluoride) 5 (Apatite) 6 (Feldspar) 7 (Quartz) 8 (Topaz) 9 (Corundum) 10 (Diamond).

Dimensions: 180 x 120 x 20 mm approx.

Weight: 500 g.



Barton perthometer

A0718 Barton perthometer 300 mm. Used to visibly evaluate rock roughness. Manufactured in tempered steel.

Dimensions: 300x120 mm.

Weight: 1 kg.

A0718/1 Barton perthometer 150 mm, similar to model A0718 but 150 mm long.



Hoek cells for triaxial tests on rocks

Standards ASTM D 5873

To use at pressures of up to 70 Mpa. Hoek cell tests are used to determine strength and elastic properties of cylindrical rock specimens subjected to triaxial compression.

The cell consists of:

A zinc-plated steel body with two side connections, one for the hydraulic pressure system and the other to expel the air from inside the cell (or to connect to a pressure measuring system).

Two zinc-plated threaded bushings used as the head of the casing.

Two tempered and ground pistons for uniform single axis load application on the specimen.

A high strength rubber sleeve to make the confined pressure uniform (can be used in other tests).

A0691 Hoek AX Triaxial Cell measuring \varnothing 30.10 x 60 mm.

A0692 Hoek BX cell measuring \varnothing 42.04 x 85 mm.

A0693 Hoek NX cell measuring \varnothing 54.74 x 100 mm.

A0694 Hoek cell measuring 1.5" \varnothing 38.10 x 75 mm.

Accessories:

Load distribution plates to prevent the piston of the cell from damaging the compression machine plates.

A0691/1 Load distribution plates for AX cell.

A0692/1 Load distribution plates for BX cell.

A0693/1 Load distribution plates for NX cell.

A0694/1 Load distribution plates for 1.5" cell.

Spare parts:

A0691/2 Set of pistons for AX cell.

A0692/2 Set of pistons for BX cell.

A0693/2 Set of pistons for NX cell.

A0694/2 Set of pistons for 1.5" cell.

A0691/3 Rubber sleeve for AX cell.

A0692/3 Rubber sleeve for BX cell.

A0693/3 Rubber sleeve for NX cell.

A0694/3 Rubber sleeve for 1.5" cell.



A0705 Laboratory core barrel probe

To obtain irregular rock samples. Supplied complete with a specimen locking system, cooling device and collection container.

Power supply: 220 V. / 50 Hz.

Weight: 50 kg approx.

Accessories:

A0705/1 Diamond core measuring \varnothing 30.10 x 200 mm long.

A0705/2 Diamond core measuring \varnothing 42.04 x 200 mm long.

A0705/3 Diamond core measuring \varnothing 54.74 x 200 mm long.

A0705/4 Diamond core measuring \varnothing 38.10 x 200 mm long.



A0706 Horizontal extractor

To extract the rock sample from the rubber sleeve without spilling the confined fluid. The adapters need to be ordered separately.

A0706/1 Set of adapters to remove NX samples \varnothing 30.10 x 60 mm.

A0706/2 Set of adapters to remove NX samples \varnothing 42.04 x 85 mm.

A0706/3 Set of adapters to remove NX samples \varnothing 54.74 x 100 mm.

A0706/4 Set of adapters to remove 1.5" samples \varnothing 1.538.10 x 75 mm.

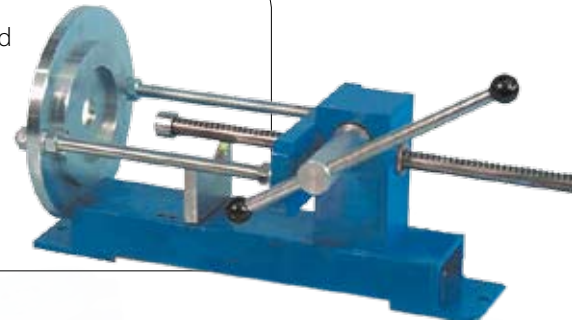

A0707 Constant pressure hydraulic system for Hoek cells

Maintains the desired pressure on the cells. Consists of a manual pump to apply pressure up to 70 Mpa, precision pressure gauge, tank and connections to distribute the pressure throughout the Hoek cell.

Weight: 15 kg approx.



Accessory:

A0707/1 Pressure stabiliser complete with pump to absorb sample volume changes and guarantee constant load during the test.

Rock permeability with Hoek cells

To measure permeability or water flow with a rock sample inserted in a Hoek cell with a controlled system of pressurised water. The test is performed with the Hoek cells used in the triaxial compression test adapted to the corresponding head. These heads

are supplied in pairs and must be ordered separately, replacing the standard head. The set is made up of a top and bottom plug, complete with additional accessories.

Models:

A0691/5 Samples measuring \varnothing 30.10 mm.

A0693/5 Samples measuring \varnothing 42.04 mm.

A0692/5 Samples measuring \varnothing 54.74 mm.

A0694/5 Samples measuring \varnothing 38.10 mm.

A0710 Permeability device mounted on a tripod, connected to the cell head. 50 ml burette with 0.1 ml divisions.

Accessories:

A0710/1 Nylon tube (25 m).

A0708 Constant oil/water pressure system permeability tests. Used to force water flow through the Hoek cell. The hydraulic pressure can be adjusted between 0 and 3500 kPa using the valve located on the control panel. The system is equipped with a motor-driven hydraulic pump and a tap to connect to the upper head of the cell. Supplied complete with a pressure gauge with a scale from 0 – 3500 kPa.

Power supply: Single phase 220/240 V. 50 Hz.

Dimensions: 310 x 300 x 400 mm.

Weight: 20 kg approx.



Ballast tests

Ballast sieves

Rectangular sieves measuring 490 x 380 mm made of a stiff painted sheet metal frame and bars with the following intermediate spans:

Reference	Opening
A0735	25 mm
A0736	16 mm
A0737	12.5 mm
A0738	8 mm
A0732	Bottom

Rectangular sieves measuring 490 x 380 mm made of a stiff painted sheet metal frame and square mesh with the following mesh sizes:

Reference	Opening
A0742	80 mm
A0743	63 mm
A0744	50 mm
A0745	40 mm
A0746	31.5 mm
A0747	22.4 mm
A0732	Bottom

Square sieves measuring 300 x 300 mm made of stainless steel in compliance with Standard EN 933-3 and with the following mesh spans:

Reference	Mesh size
A0542/I	40 mm
A0541/I	31.5 mm
A0540/I	25 mm
A0539/I	20 mm
A0538/I	16 mm
A0537/I	12.5 mm
A0536/I	10.0 mm
A0535/I	8.0 mm
A0534/I	6.3 mm
A0533/I	5.0 mm
A0532/I	4.0 mm
A0531/I	3.15 mm
A0530/I	2.50 mm
A0543/I	Bottom



A0766 Template for aciculars

Mobile template with two ball bearings for tests with aciculars and flakes.

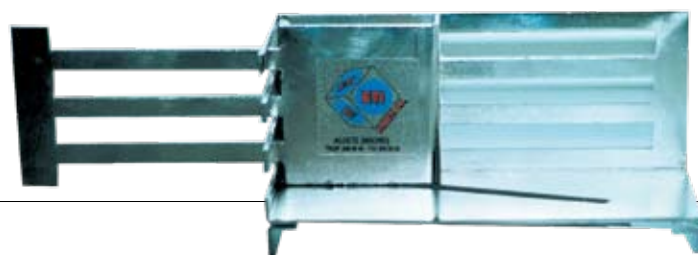

3

CEMENTS



Sampling

Standards EN 196/7; UNE 80.401; ASTM C 183; AASHTO T127

C0001 Sampling equipment for cement in sacks

For sampling cement in sacks. Consisting of two concentric brass tubes with lengthways slots. The inner tube rotates and closes the slots, preventing the sample from escaping.

Internal volume: 1.2 litres.

Dimensions: Ø 32 x 700 mm.

C0002 Sampling device

For sampling cement in sacks or transport vehicles. Consisting of two concentric brass tubes with lengthways slots. The inner tube rotates and closes, preventing the sample from escaping.

Internal volume: 3 litres.

Dimensions: 40x1500 mm.

C0003 Sampling spoon with handle



Chemical tests

Standards EN 932/1; UNE EN 196-2

C0005 Flame photometer

Designed for routine determination of Sodium (Na) and Potassium (K); with the possibility of incorporating additional filters to measure Lithium (Li), Barium (Ba) and Calcium (Ca). For user safety, the device includes an automatic power failure detector, making it ideal for industrial, clinical and educational use.

Technical characteristics:

Wavelength range: 405 - 700 nm.

Reading display: High contrast digital (LCD).

Zero: Automatic.

Photometric range: 0 - 100.0%.

Transmittance: 0.000 - 3.500.

Absorbance: 0 - 9.999.

Concentration/Factor 9.999

Photometric linearity: 1%.

Lamp: Long-lasting tungsten.

Photometric accuracy: 1 %.

Repeatability: ± 0.5% T.

Response time: 3 seconds.

Stability: Drift of 0.003 h after 1/2 h warm up at 0 A.

Data input: Membrane keypad.

Dimensions: 225 x 230 x 90 mm.

Weight: 1.8 kg.



Accessories:

C0005/1 Barium filter.

C0005/2 Calcium filter.

C0005/3 Lithium filter.

C0005/4 Air compressor.

C0005/5 Butane regulator.

Supplied complete with an electronic power failure safety device, sodium and potassium filters, connection tubes and collars, compression plug, water separator, fuses and instruction/maintenance manual.

Determining cement fineness

Standards EN 196-6; UNE 80.122; ASTM C 204; BS 4359; NF P-15 442; AASHTO T153

Cement fineness is a property that can be carefully controlled during the manufacturing process. The total specific surface of cement represents the surface area available for hydration. There are several methods for measuring the specific surface of cement.

Air permeability is the method used that provides the most accurate and repetitive results.

C0010 Blaine Permeability Meter

Used to determine the specific surface of cement. The instrument consists of a support with a U-shaped manometer tube, a stainless steel cell with a perforated disc and a piston, a suction pump, manometer fluid and filter paper.

Dimensions: 380 x 150 x 150 mm.

Weight: 1.5 kg.

Accessories:

C0010/2 Reference cement 114p (10 g).

C0010/8 Glass thermometer -10 +50 °C.

Spare parts:

C0010/1 Filter paper (1000 units).

C0010/3 Manometer fluid (100 ml).

C0010/4 U-shaped manometer tube.

C0010/5 Stainless steel cell with perforated disc.

C0010/6 Perforated disc.

C0010/7 Suction pump.



Standards UNE EN 451-2; DM 3/6/68

C0012 Apparatus to determine residue by means of water flow

Used to determine the fineness of cement. Consisting of a shower type spraying lid with a stopcock and pressure gauge; a sieve measuring \varnothing 85 x 95 mm high, made of chrome plated brass and two stainless steel meshes with mesh sizes of 0.18 and 0.09 mm. The test consists in placing a 25 g cement sample in the sieve and washing it with the shower for 2 minutes. The cement residue that remains is obtained by drying the sieve at 110°C.

Dimensions \varnothing 80 x 130 mm.

Weight: 2.5 kg.

Spare parts:

C0012/1 Spare mesh with mesh size 0.18 mm.

C0012/2 Spare mesh with mesh size 0.09 mm.



C0013 Apparatus for determining fly ash by wet method

Consisting of a special sieve measuring \varnothing 50 mm made of stainless steel and with a mesh size of 0.045 mm, a spray nozzle of \varnothing 17.5mm with 17 holes measuring \varnothing 0.5 mm according to specifications, an 80 mm pressure gauge and connection couplings to the water supply.

Approximate weight: 3 kg



Consistency

Determining setting times and the consistency of cement requires the use of a clean mix with standard consistency. The Vicat test is generally indicated as the method to use in order to determine the water content, which produces the required consistency. Mortar, silt and cement consistencies are determined using a probe penetration method, as specified in EN standards for these types of materials. The setting point or useful life of fresh mor-

tar is also determined by the probe penetration method. Other frequently used methods include the jolting table or the falling ball method. The corresponding instruments required to perform these tests are described in this section.

Vicat method

Standards EN 196-3; ASTM C187, 191; BS 4550; AASHTO T131; NF P15-414 P15-431; DIN 1168

This method is used to determine the amount of water needed to produce a cement paste with standard consistency.

C0015 Manual Vicat needle

Consisting of a base with support, a sliding probe measuring \varnothing 10 mm and weighing 300 g, and a graduated scale. Supplied complete with a \varnothing 1.13 mm needle for initial setting and a \varnothing 1.13 mm needle for final setting, a \varnothing 120 mm glass base and a tapered mold measuring (EN) \varnothing 70/80 x 40 mm.

Accessories and spare parts

- C0015/1** \varnothing 1 mm needle for initial setting (ASTM, AASHTO).
- C0015/2** \varnothing 1.13 mm needle for initial setting (EN, BS, DIN, NF, UNE).
- C0015/3** \varnothing 1.13 mm needle for final setting (EN, NF, DIN, BS).
- C0015/4** Additional weight of 700 g (EN, NF).
- C0015/5** Glass base (EN, ASTM).
- C0015/6** Vicat mold \varnothing 70/80x40mm (EN, NF).
- C0015/7** Vicat mold \varnothing 60/70x40mm (ASTM, AASHTO).
- C0015/8** \varnothing 10 mm probe (EN, ASTM).
- C0015/9** Bronze mold \varnothing 80/90x40mm (BS).
- C0015/10** Bronze split mold \varnothing 80/90x40 mm (BS).
- C0015/11** Glass thermometer ranging from -10 to 50°C .
- C0015/12** \varnothing 1.13 mm hardened needle for initial setting. (EN, BS, DIN, NF, UNE).



C0015/Y Vicat manual needle for plaster

Consisting of a base, a sliding probe measuring 10 mm and weighing 100 g, and a graduated scale. Supplied complete with needle, \varnothing 120 mm glass base and tapered mold in compliance with UNE standards.

Accessories and spare parts:

- C0015/Y/1** 100 g probe.
- C0015Y//2** Conical penetration needle of \varnothing 8 x 50 mm long.

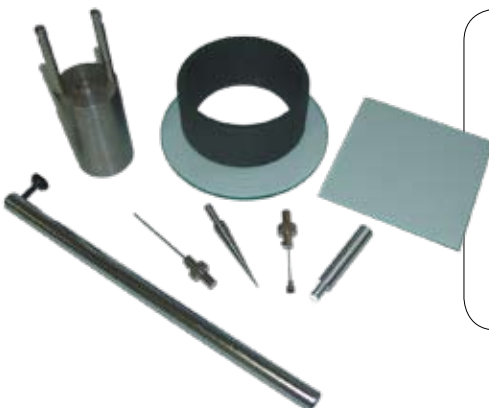

Consistency

Standards EN 196/3; D.M. 3/6/68; ASTM C191; DIN 1164 1168; BS 4550; NF P15-414; P15-431; AASHTO T131

This type of test has traditionally been conducted using a simple apparatus consisting of a base and a support, a sliding probe and a graduated scale (manual Vicat needle) to read the penetration depth.

The apparatus described here is completely automatic, thereby eliminating possible test inaccuracies and guaranteeing maximum reliability. This instrument records the results on paper, so an operator is not necessary and the progress of the test can be determined without doubts or inaccuracies.

C0016 Automatic Vicat apparatus

Automatic Vicat needle to determine the setting time, operating at fixed intervals, with data recording. With this needle, the entire process is automatic from the moment the test parameter are selected, thus preventing any of the possible errors made during a manual process. The equipment also includes a program for testing plaster, in compliance with DIN 1168. The probe weighs 300 g (1000 g AFNOR) and needle diameter is 1.13 mm (1 mm ASTM). The equipment performs a complete penetration cycle in 30 seconds or at intervals of 1 - 5 - 10 - 15 - 30 minutes between penetrations.

The equipment enables the selection of any of the following test programs:

Standards EN - AFNOR - BS - DIN

26 penetrations, mold Ø 70/80/40.

Standard ASTM

41 penetrations, mold Ø 60/70/40.

Standard UNE

90 penetrations, mold Ø 80/90/40.

Plaster tests as per DIN 1168

22 penetrations.

This apparatus is made of a light alloy making the instrument sufficiently solid and resistant to withstand any working conditions. Its light weight makes it easy to transport. Testing times ranging from 1 to 99 minutes can be selected and it has program start delay ranging from 0 to 360 minutes. The sample tray turns automatically so the needle penetrates in a different position every time from a pre-selected position depending on the selected testing standard. Optionally and on request, an automatic needle cleaning device can be mounted, without modifying the section or the results of the test. Initial and final setting times are drawn on the diagram based on the number and depth of the penetrations. When the test is completed, the device stops automatically. In the event of a power failure, an error message will appear on the display when the test restarts to indicate the time when the interruption occurred (number of penetrations made and test time lapsed).



Technical characteristics:

Membrane keypad with backlit LCD display of 128X64 pixels.
 Needle height calibration programme.
 Test execution programme.
 Language selection, Spanish, French, German and Italian.
 Support tray for glass base with automatic centring system.
 Automatic system to adjust the pressure of the chart recorder pen on the paper.
 Power supply: 15V DC – with electric power supply 100-250V/1ph/43-63Hz.
 Dimensions: 200x420x300 mm.
 Weight: 11 kg.

The apparatus is supplied complete with:

1.3 mm diameter needle (EN, BS, DIN, NF, UNE).
 1 mm diameter needle (ASTM, AASHTO).
 300 g probe.
 Ø 70/80 x 40 mm tapered mold (EN).
 Ø 120 mm glass base.
 Chart recorder pen.
 Chart recorder paper (100 units).
 Instructions manual.
 Test accessories for different standards must be requested separately.
 With the specific accessories, available to order, the apparatus can also perform the consistency test for GIPS plasters.

Accessories and spare parts:

C0016/1 Ø 1 mm needle for initial setting (ASTM, AASHTO).
C0016/2 Ø 1.13 mm needle for initial setting (EN, NF, DIN, BS).
C0016/3 Ø 1.13 mm needle for final setting (EN, NF, DIN, BS).
C0016/4 Additional weight of 700 g (EN, NF).
C0016/5 Needle cleaning device.
C0016/6 Consistency test probe.
C0016/7 Ø 10 mm consistency test probe (EN, ASTM).
C0015/6 Vicat mold Ø 70/80x40 mm (EN, NF).
C0015/7 Vicat mold Ø 60/70x40 mm (ASTM, AASHTO).
C0015/9 Bronze mold Ø 80/90x40mm (BS).
C0015/10 Bronze split mold Ø 80/90x40 mm (BS).
C0016/10 Glass base.
C0016/11 Set of five chart recorder pens.
C0016/12 Chart recorder paper (100 units).
C0016/13 300 g probe.

Accessories for plaster:

C0016/14 Cone-shaped mold.
C0016/15 100 g aluminium probe.
C0016/16 Tapered point.

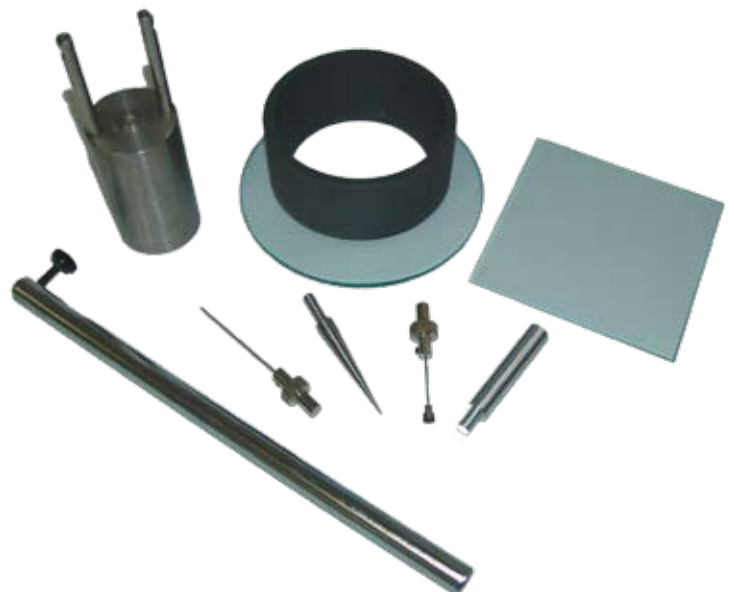

C0016/18 Thermostat controlled heating and cooling unit

The system produces water at a controlled temperature of $20^{\circ}\text{C} \pm 1^{\circ}\text{C}$ that is recirculated in the C0016/17 tank for testing at controlled temperature and humidity levels, as indicated in Standard EN 196-3. It can be used with a single Vicat needle.

Power supply:

Single phase 220-240 V/50 Hz. 1150 W.

Dimensions:

625 x 380 x 410 mm.

Weight: 26 kg.



C0016/17 Molding tank

For testing samples immersed in water. The test must be performed in a room with controlled temperature of $20^{\circ}\text{C} \pm 1^{\circ}\text{C}$. The saturated humidity is obtained by immersing the sample in water as indicated in Standard EN 196-3.

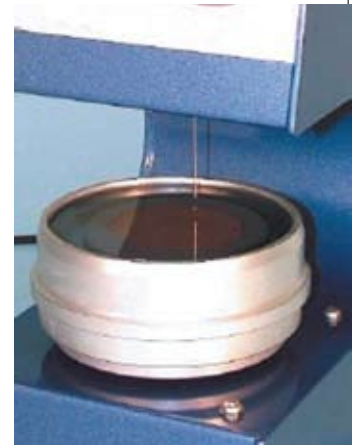

Gilmore method

Standards ASTM C91, C141, C266; AASHTO T 154

C0017 Gilmore Apparatus

Used to determine the setting time of cement. Consisting of two horizontal supporting arms, a vertical adjustable supporting shaft and two needles with stainless steel tips. Made of a light aluminium alloy, it includes two calibrated weights as per specifications.

Weight: 3 kg.

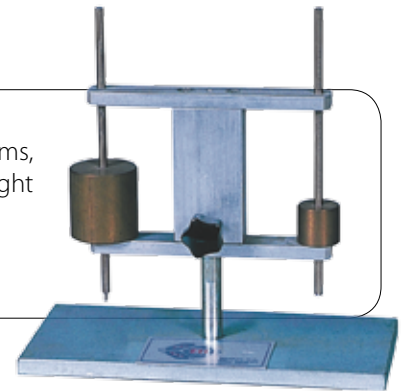

Standards EN 413-2, 459-2, 1015-4.

C0018 Penetration plunger device

Used to determine consistency in mortar, silt and cement. The apparatus consists of a robust base with a device for locating the testing cup. Fall height can be adjusted up to 100 mm. The equipment is supplied complete with test cup and tamper.

Dimensions: 200 x 200 x 700 mm.

Weight: 10 kg.



Jolting tables

Jolting tables are used to determine cement and mortar consistency. PROETI manufactures several models, depending on the standard required.

Standards UNE 83.258

C0019 Manually operated jolting table

Consisting of a round glass table measuring $\text{Ø} 350$ mm, supported by a cast steel base in the form of a tripod and a crank that raises a cam allowing the table to fall from a height of 10 mm. Supplied complete with a $\text{Ø} 100$ mm bronze mold and a tamper made of non-absorbent material.

Dimensions: 300 x 290 x 300 mm.

Weight: 20 kg.



Standards EN 1015-3; EN 459-2

C0020 Motor-driven jolting table

Consisting of a round stainless steel table measuring \varnothing 300 mm, supported by a cast steel base in the form of a tripod and a gear motor that raises a cam allowing the table to fall from a height of 10 mm. Supplied complete with an electronic impact meter with automatic stop mode, a \varnothing 100 mm bronze mold and a wooden tamper.

Power supply: 220 V. / 50 Hz.

Weight: 45 kg.

Accessories

C0019/1 \varnothing 70/100 x 60 mm tapered mold as per EN.

C0019/2 \varnothing 40mm wooden tamper.

Spare parts

C0019/3 Jolting table glass.



Standards ASTM C230; BS 4551

C0021 Manually operated jolting table for mortar.

Consisting of a round stainless steel table measuring \varnothing 254 mm, supported by a cast steel base in the form of a tripod and a crank that raises a cam allowing the table to fall from a height of 12.7 mm. Supplied complete with \varnothing 101.6 mm bronze mold and wooden tamper.

Weight: 20 kg.

Accessories

C0021/1 \varnothing 101.6/69.9 x 50.8 mm tapered mold.

C0021/2 12 x 25 x 250 mm wooden tamper.



Standards ASTM C230; BS 4551

C0022 Motor-driven jolting table for mortar

Consisting of a round stainless steel table measuring \varnothing 254 mm, supported by a cast steel base in the form of a tripod and a gear motor that raises a cam allowing the table to fall from a height of 12.7 mm. Supplied complete with an electronic impact meter with automatic stop mode, a \varnothing 101.6 mm bronze mold and a wooden tamper.

Power supply: 220 V. / 50 Hz.

Weight: 25 kg.

Accessories

V0076 Sample diameter gauge (200 x 0.02).

V0077 Sample diameter gauge (300 x 0.02).

V0079 Digital sample diameter gauge (200 x 0.02).



Falling ball consistency

Standards BS 4551-1, 6463-4

C0023 Falling ball apparatus

Used to measure the consistency of cement mortar. The test consists in allowing a \varnothing 25 mm acrylic ball fall freely from a height of 250 mm onto a mortar sample contained in a mold measuring \varnothing 100 x 25 mm. The penetration of the ball in the mortar determines the consistency of the sample being tested.

The apparatus basically consists of a height adjustable vertical support, a falling device, an acrylic ball and a brass mold.

Weight: 6 kg.

Accessories

C0023/1 Device to measure the penetration of the ball in the sample. Consisting of a metal support with 25 x 0.01 mm dial gauge.

Spare parts

C0023/2 \varnothing 100 x 25 mm brass mold.

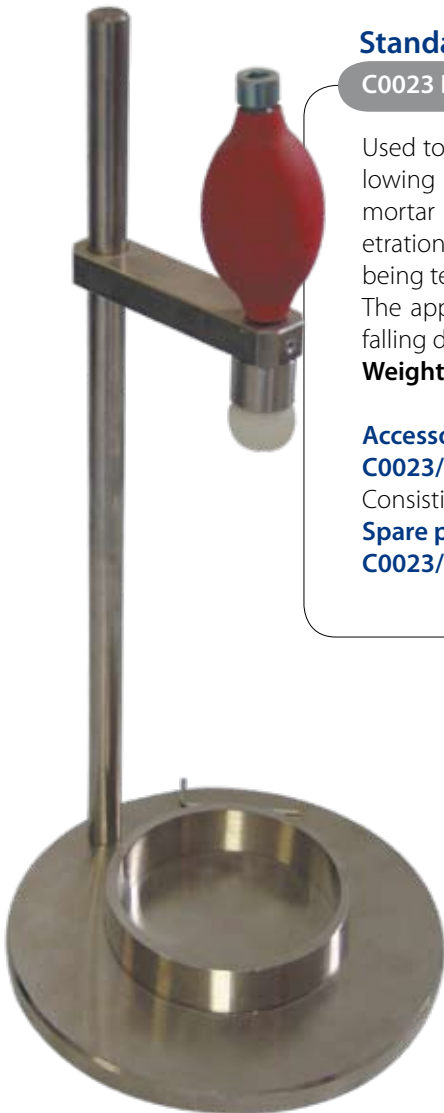

Standards EN 413-2; AFNOR P18-452

C0024 LCL Plasticity meter

Used to verify the homogeneity of a fresh mortar mix based on its plasticity, as specified in Standard EN 413-2. The unit consists of a small rectangular container divided by a removable separator and a vibrator coupled to one of the walls of the container. The test consists of introducing the fresh mortar into the first compartment and removing the spacer that divides the container. This automatically activates the vibrator; the test ends by recording the vibration time required for the sample to spread homogeneously over the second compartment.

Power supply: 220 V. / 50 Hz.

Dimensions: 400 x 200 x 200 mm.

Weight: 18 kg.



Stability and expansion

Cement consistency is especially important. It is essential that it does not experience any notable change in volume once hardened. Volume variations are not apparent over a period of months

or even years. Therefore, test methods have been developed to determine the consistency of the material to be tested.

Le Chatelier test

This method is used to determine dimensional stability or expansion in cement.

Standards UNE EN 196-3; UNE 80.103; EN ISO 9597; BS 6463; NF P15-4362

C0030 Le Chatelier water bath

Made of stainless steel and equipped with 1000 W heating elements to enable the water to reach boiling point in 25 minutes. Temperature regulation system controlled by electric thermostat, from ambient temperature to 100°C. Supplied complete with heating element cover-tray, cover and thermometer. Provides capacity for 6 simultaneous tests.

Power supply: 220 V. / 50 Hz.

Internal dimensions: 310 x 300 x 150 mm.

Spare parts

C0031 Le Chatelier mold, Ø 30 x 300 mm long.

C0032 Glass plates (2), 50 x 50 mm.

C0033 Le Chatelier clamp to hold the glass plates.

C0033/1 Equipment to check the Le Chatelier clamps.

C0034 100 g weight to place on the glass plates.

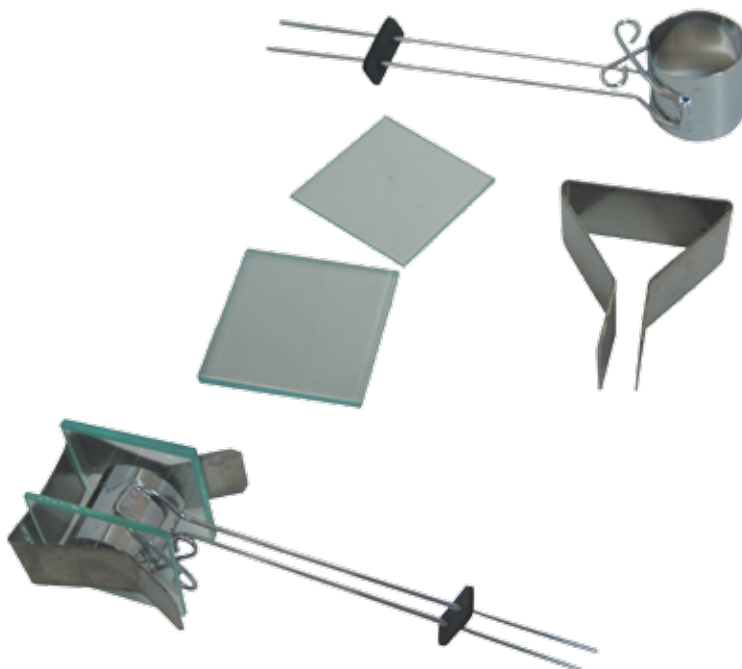

Autoclave for expansion tests

This method is used to determine dimensional stability or expansion in cement.



Standards ASTM C141, C151; UNE 80113

C0035 Autoclave

Autoclave designed for performing expansion tests on cement specimens. Consisting of a high pressure cylindrical container made of special heat insulated steel and coated in a protective layer or film. Heating is carried out by means of two electrical resistance elements. The control panel includes: a pressure gauge with an integrated pressure regulator, a thermostat, and buttons for temperature input and equipment start/stop. The autoclave includes a safety valve.

Power supply: 1 x 220-240 V. 50 Hz. 3500 W. 295 psi.

Internal dimensions: 450 x 475 x 1080 mm.

Weight: 75 kg.

Standards ASTM C490, C348; BS1 881, 6073; NF P18-427; UNE 80113

Expansion test molds

C0040 Three-gang prism mold for producing specimens measuring 25.4 x 25.4 x 287 mm, made of treated and ground steel, fully dismountable, in compliance with UNE 7207.

C0041 Two-gang prism mold for producing specimens measuring 25 x 25 x 250 mm, made of treated and ground steel, fully dismountable, in compliance with ASTM C490.

C0042 Two-gang prism mold for producing specimens measuring 75 x 75 x 254 mm, made of treated and ground steel, fully dismountable, in compliance with BS 1881, 6073.

C0043 Three-gang prism mold for producing specimens measuring 40 x 40 x 160 mm, made of treated and ground steel, fully dismountable, in compliance with ASTM C348.

C0044 Three-gang prism mold for producing specimens measuring 70 x 70 x 280 mm, made of treated and ground steel, fully dismountable, in compliance with NF P 18-427.

C0040/1 Contact points for C0040 mold (pack of 12).

C0040/1 Contact points for C0041 and C0042 molds (pack of 12).

C0040/1 Contact points for C0043 and C0044 molds (pack of 12).

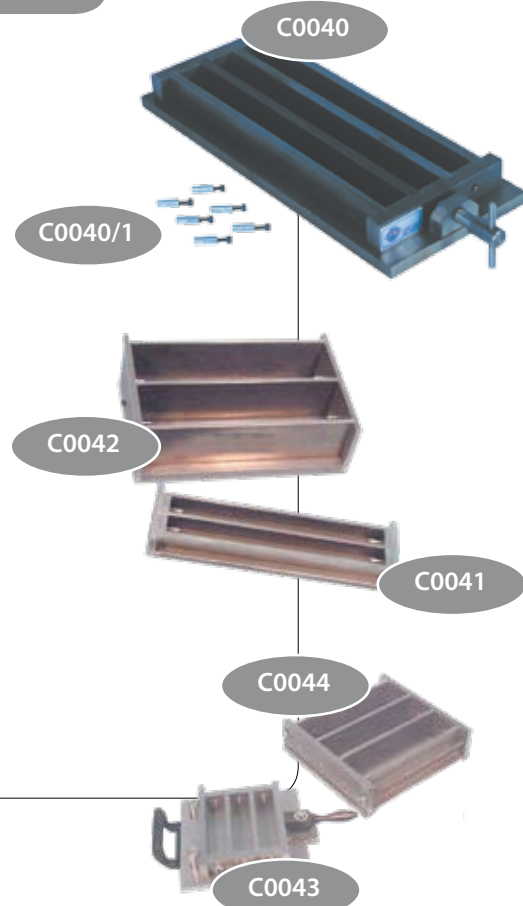

Standards EN 1367-4, 12617-4; ASTM C151; C490; NF P15-433; P18-427; BS 1881:5, 6073, 812: 102; DIN 1164

C0037 Shrinkage measuring device

Designed to measure linear variation in mortar specimens. Consisting of a steel frame with an adjustable bridge at the top and a dial gauge measuring 5 x 0.001mm. The reference bar must be ordered separately.

Dimensions: 0180x450 mm

Weight: 10 kg.

Accessories:

C0037/1 Reference bar for specimens measuring 25x25x250 and 75x75x254 mm as per ASTM C490 y BS 1881.

C0037/2 Reference bar for specimens measuring 40x40x160 as per EN 12617, ASTM C348 and NF P15-433.

C0037/3 Reference bar for specimens measuring 70x70x280 mm as per NF P18-427.

C0037/4 Reference bar for specimens measuring 50x50x200 mm as per EN 1367-04.

V0014 Dial gauge, 5 x 0.001 mm.

V0023 Digital dial gauge, 25 x 0.001 mm, with RS232 connection to a PC.

V0023/1 Connection cable from the digital dial gauge to the PC.



Construction lime



Standards EN 459/2

C0058 Apparatus to determine apparent density

Consisting of a cylindrical container with capacity for 1 L, a connection element with closing valve and a feeder head with closing lever mounted on springs to hold and release the valve.

Weight: 5 kg

Lime stability test

Standards EN 459/1 - BS 890, 1191

C0038 PAT Test



Used to determine the stability of lime and plaster. Consisting of a brass mold measuring $\varnothing 100 \times 5$ mm high, with an inner angle of 5° and a glass base plate. Three molds are needed to perform the test.



Standards EN 459/2

C0062 Hydration container

Designed to determine the hydration properties of quicklime. Comprising a metal container with a thermally insulated double wall and lid.

Internal dimensions: $\varnothing 113 \pm 0.5 \times 140$ mm.

Total dimensions: $\varnothing 155 \times 160$ mm.

Standards EN 459/2

C0059 Kleine apparatus to determine the carbon dioxide level

Consisting of a 50 ml Erlenmeyer flask for decomposition, an absorption container with a KOH (potassium hydroxide) solution, levelling bottle with a sealing liquid, a burette, a glass tube for coating, stopcocks and capillary tubes, all of which is mounted on a wooden panel.

Approximate weight: 10 kg.

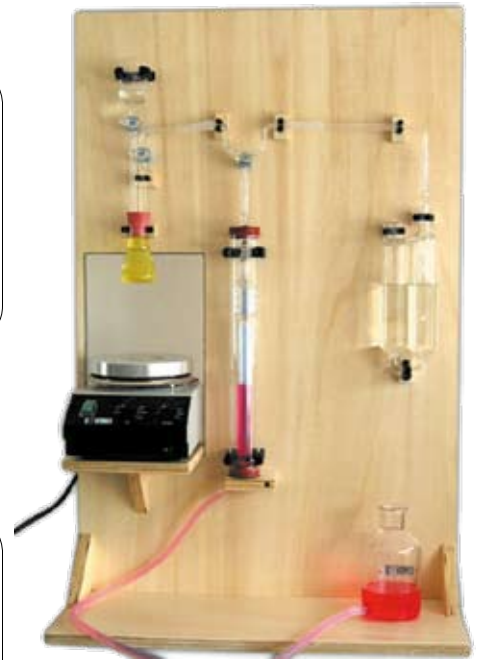

Plaster expansion

Standards BS 1191; UNE 6782

C0039 Plaster extensometer

Used to measure linear expansion in plaster mixes. Consisting of a V-shaped container measuring 100 x 60 x 25 mm with a square, closed end that transmits the movement to a 10 x 0.01 mm dial gauge.

Dimensions: 250 x 80 x 60 mm.

Weight: 3 kg.

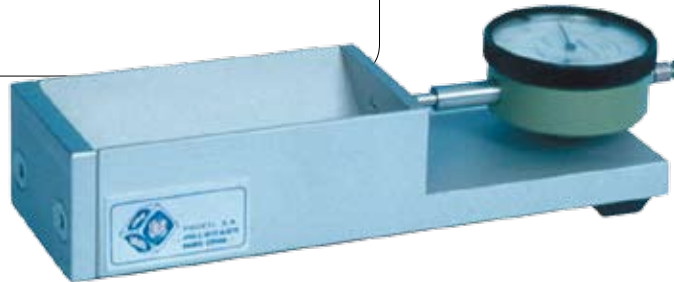

Cement hydration heat

Standards EN 196/8 – ASTM C 186 – BS 4550, 1370 – DIN 1164

C0045 Calorimeter

Designed to determine the hydration heat of hydraulic and Portland cement. Consisting of a Dewar glass housed in a wooden box opened split into two halves for easy access and easy replacement. A second wooden box, also split into two halves, houses the first box and guarantees perfect heat insulation. The device is supplied complete with a constant speed electrical stirrer, Beckmann thermometer and glass funnel. The stirrer paddle must be ordered separately, depending on the test standard.

Power supply: 1 x 230 V. 50 Hz. 150 W.

Dimensions: 350 x 250 x 680 mm.

Weight: approx. 12 kg.

Accessories

C0045/1 Stirrer paddle in compliance with EN 196/8.

C0045/2 Stirrer paddle in compliance with ASTM C186.

S0023 Electrical paraffin heater.

Spare parts

C0045/3 Dewar Glass.

C0045/4 Beckmann Thermometer.

C0045/5 Glass funnel.



Occluded air and density

Mortar has a wide variety of uses, the most frequent of which is that of bonding bricks and blockwork. Both occluded air and density are important if the hardness and strength of the mortar are to be adequate. Specifications often require minimum den-

sity and occluded air values. The devices described below have been designed to perform standard tests on mortar and similar materials.

Determining occluded air in mortar

Standards UNE EN 1015/7; EN 413/2, 459/2, - UNE 83.815 - DIN 18.555

C0050 Manual air entrainment meter, capacity 1 l

Designed to determine the volume of air contained in fresh mortar and silt mixtures. The reading is performed directly using a pressure gauge that indicates the percentage value, with a range 0 – 50%. Supplied with a manual air pump.

Volume: 1 l.

Dimensions: Ø 200 x 320 mm.

Weight: 3.5 kg.



C0051 Electric air entrainment meter, capacity 1 l

Designed to determine the volume of air contained in fresh mortar and silt mixtures. The reading is performed directly using a pressure gauge that indicates the percentage value, with a range 0 – 50%. This model includes an electric mini-compressor that supplies pressurised air at a constant pressure during the entire test.

Power supply: 1 x 230 V / 50 Hz.

Volume: 1 l.

Dimensions: Ø 200 x 320 mm.

Weight: 4 kg.

Accessories:

C0050/2 Filling hopper.



Standards ASTM C185 – AASHTO T 137

Density method for determining air content in mortar mixtures

The density method for determining air content in mortar provides more repeatable results than those provided by the pressure method. The equipment needed is simple, although it does require knowledge of the specific gravity of the components and the mix proportions by weight.

C0060 400 ml measure, 76 x 90 mm.

C0056 Glass base plate, 100 x 100 mm. Thickness: 6.4 mm.

C0057 Hard plastic tamper, Ø 37.5 ± 0.5 mm.

C0061 Leveller, 100 x 3 x 19 mm.



Standards UNE EN 196-2; 1996

V9994 Thermo-cement spectrophotometer system

The thermo-cement system is a unit consisting of a spectrophotometer with a 200 ml thermostated cuvette for titrimetric assessment by photometry, an adjustable speed paddle stirrer and PID digital temperature controller for temperatures of up to 99.9°C with 0.1°C of accuracy. The unit complies with standard UNE – EN196-2:1996 for the colorimetric analysis of cement.

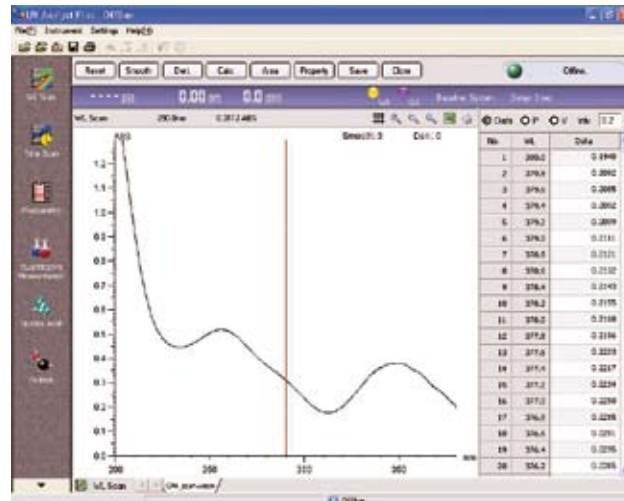

Spectrophotometer:

200 ml heated cuvette and Pt100 temperature sensor.
 Concave diffraction grating, 1200 lines.
 Bandwidth: 5 nanometres.
 Range: 330 – 850 nm (in 0.1 nm).
 Scales: Abs 0.170-2.000.
 Trans 0-150%.
 Scanning: from 60 to 800 nm/minute.
 LCD screen, graphic data and printing.
 RS232 port and parallel port.

Supplied with a stirrer and an opening in the lid of the sample compartment to adapt the assessment burette and the stirrer.

Power supply: 230V/50-60 Hz.

Digital visible spectrophotometer for the analysis of cement in compliance with UNE-EN196.2:1996, with thermostatic cuvette tray, cuvette and stirrer.



V9994/1 Temperature controller d-85

Range: ambient to 99.9°C.

Accuracy: ± 0.1°C.

Proportional adjustment: PID.

Digital display: current and programmed temperature.

Power supply: 230V / 50-60 Hz.

Spare parts

V9994/2 200 ml optical glass cuvette.

V9994/3 Adjustable paddle stirrer.

Determining workability

This test consists of pouring 1 l of sample into the hopper, ensuring that it is evenly distributed. Thirty seconds later, the discharge bar is pulled slowly upwards to release the paste and allow it uniformly run through the slump trough. The “slump value” is

determined by measuring the horizontal distance between the centre of the discharge opening and the end of the paste after 30 seconds.

Standards EN 13395-2

C0064 Apparatus for testing the slump of paste

Made of galvanised steel sheeting, consisting of a filling funnel measuring \varnothing 200 mm with an opening of 35 mm, a discharge bar to release the paste, and the slump trough.

Dimensions: 930 x 150 x 350 mm

Weight: 12 kg



Standards EN 1015-9

C0063 Complete workability period unit in accordance with standard EN 1015-9

Used to determine the workability period of a sample of fresh mortar. After a slump value is defined, the workability can be defined by measuring the time in minutes until the sample reaches its stiffness or workability limit.

The unit consists of:

- Rigid brass mold.
- Penetration probe.
- Brass washer and support.
- Scale not included.



Relative density of hydraulic cement

EN 196/6; UNE 83.103; NLT 155; ASTM C188; AASHTO T 133; BS 4550

C0065 Le Chatelier Flask

For determining the density of hydraulic cement. Graduated between 0 and 1 cm³ and between 18 and 24 cm³.

Capacity: 250 ± 0.05 cm³.



Relative density of cement

Standards EN 196/6; NLT 157; ASTM C91, C110

C0067 Equipment for measuring the apparent density of cement

As specified by the "Committee of Construction Materials Testing Methods". Consisting of a funnel-shaped sieve with a tripod, with 1 l capacity, spatula and leveller.

Dimensions: Ø 350 x 520 mm.

Weight: 3 kg.



Apparent density of plaster

Standards UNE 102032

C0067/1

Equipment to determine the apparent density of plaster.



Grout fluidity

Standards EN 455; NF P18-358, P18-507

C0068 Funnel viscosity meter

Designed to measure the viscosity of fluid cement and mortar mixtures. Supplied complete with four interchangeable nozzles measuring Ø 8, 9, 10 and 11 mm for use depending on mortar viscosity, a base plate, a height adjustable plate and a graduated plastic container.

Dimensions: Ø 160 x 370 mm.

Weight: approx. 8 kg.

Accessories:

C0068/1 Ø 12.5 mm interchangeable nozzle.

C0068/2 Ø 150 mm sieve, mesh size 1.5 mm.

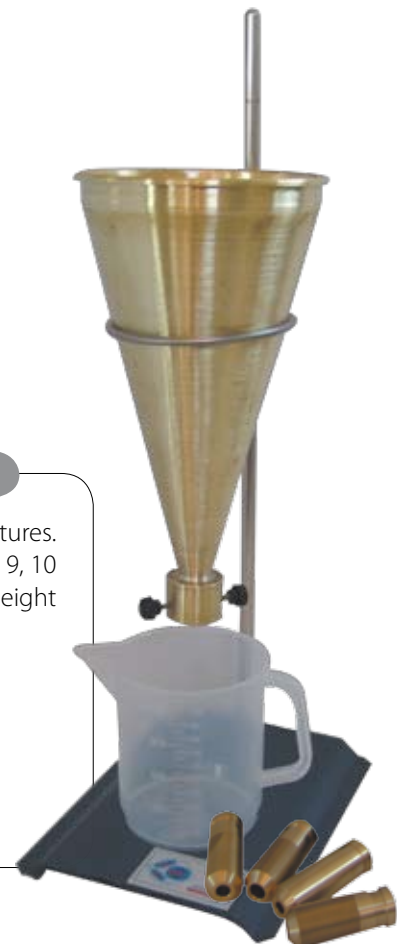



Determining permeability

Standards EN 1015-19, UNE EN 1015-21

C0073 Apparatus to determine water permeability.

In compliance with Standard UNE EN 1015-21. Consisting of a metal base to hold the 1000 ml graduated glass burette, a metal cone measuring \varnothing 200 mm and 100 mm high.

C0072

Equipment to determine the steam permeability hardened mortar used in rendering and plastering. Consisting of a round PVC test container with an intake section of approx. 0.02 m^2 on which the test specimen is sealed. Complete with airtight seal.



C0071

Round mold made of flexible material to facilitate removal of the sample from the mold.



Water retention

Standards ASTM C91, C110

C0070 Water retention equipment

Designed to determine how much water is retained in cement and silt. Consisting of a water suction device, three-way stopcock, adjustable base support, mercury column and filtering funnel.

Dimensions: 400 x 300 x 600 mm.

Weight: approx. 8 kg.

Cracking test

Standards NF P15-434

C0075 Mold

Designed to measure the formation of cracks in cement. Consisting of a base plate, split mold, central crown and collar.

Weight: 8 kg.



Mixing, molding, curing and breaking

The results of strength tests on cements and other materials such as lime and fly ash depend on the method and the quality of the equipment used. With publication of ISO 679 and the conse-

quent publication of EN 196/1, a standard system has been developed for strength tests, based on the compression strength of mortar prisms.

Mixing

Standards EN 196/1, 196/3, 413/2, 459/2; ISO 679; ASTM C305; AASHTO T 162

The correct sequence for homogeneous mixing is important if the results are to be repetitive and uniform. Mixers should be sufficiently powerful in order to ensure that the speed of the motor is not affected by the components of the mixture; they are designed to ensure that mixing action and paddle do not decompose the individual sand particles and preferably to provide automatic mixing cycles.

C0085 Electrical laboratory mixer

Of a robust construction, with two planetary rotation speeds for the mixing process.

Vat capacity: 5 litres.

Supplied complete with vat, stainless steel paddle, sand dispenser and protection door that stops the test automatically if opened, in compliance with Directive EC 89/392.

Power supply: 380 V three phase 50 Hz.

Dimensions: 340 x 460 x 500 mm.

Weight: 44 kg.



C0086 Automatic laboratory mixer

Of a robust construction, especially designed for the effective mixing of cement and mortar pastes. Including three cycles with automatic mixing sequences.

Vat capacity: 5 litres.

Equipped with two speeds: 140 ± 5 or 275 ± 5 rpm for rotation and 62 ± 5 or 125 ± 5 rpm for planetary movement.

Providing the option to select automatic mixing or one of the two automatic programmes.

When a programme is selected, speed changes, stops and mixing times are notified by a sound signal. Equipped with an automatic dispenser for filling the hopper with sand within the required 30 time frame. Supplied complete with vat, stainless steel paddle, sand dispenser and protection door that stops the test automatically if opened, in compliance with Directive EC 89/392.

Power supply: 380 V. three phase 50 Hz.

Dimensions: 340 x 460 x 700 mm.

Weight: 45 kg.

Accessories and spare parts:

C0085/1 Stainless steel vat, capacity 5 l.

C0085/2 Mixing paddle with an anchoring system, as per EN 196/1.

C0085/3 Mixing paddle adapter.

C0085/4 Dispensing hopper for manually adding water, additives, etc. to the vat during the various mixing cycles.

C0085/5 Standard sand, as per EN 196/1. In bags of 1,350 g.



C0087 Computerised, programmable automatic mixer

Of a robust, durable construction for intensive use in the laboratory.

Characteristics:

Silent, low maintenance planetary transmission.

Automatic sand dispenser designed to guarantee correct filling, free of residue and without separating fine and coarse parts.

Additive dispenser (see accessory C0087/1).

Automatic water dispenser (see accessory C0087/2).

Transparent safety shield for the mixing area, allowing you to watch the mixture during the test and check the rotation speed on the rpm counter.

Supplied complete with polished stainless steel vat and paddle. Easy, fast vat assembly and removal.

Programming:

Different programmes with automatic mixing cycles as per standards.

The operator can use a PC to personalise up to 3 different mixing cycles.

Sound signals synchronised with the test cycles.

High resolution and contrast LCD display to view the status of the various test functions.

Allows manual mixing cycles.

Able to store up to 100 tests and upload them to a PC via an RS232 connection.

- Various language selection options.

- Detailed indication of all the test parameters, displays the current cycle and its status via a progress bar, speed, active phase (sand, water) status of the test (correct execution or test interruption with loss of results) current test type.

Power supply: 1x 220-240V 50Hz.

Dimensions: 530 x 620 x 780 mm.

Weight: 85 kg.

Accessories and spare parts

C0087/1 Dispensing hopper for manually adding water, additives, etc. to the vat during the various mixing cycles.

C0087/2 Dispensing funnel with hopper for automatically adding water (via software) to the vat during the mixing phase.

C0087/4 Polished, stainless steel mixing paddle.

C0087/3 Stainless steel vat, capacity 5 l.



Sample preparation

Standards EN 196/1, 196/3, 413/2, 459/2; ISO 679; NF P15-413 P18-401; ASTM C109, 348; AASHTO T 106; BS 4550

Proper preparation during the molding of cubes and prisms is essential if the strength tests to be performed on the sample are to be significant. The molds should be made of a material capable of withstanding tough operating conditions.

The molds described in this section have been designed and manufactured according to the requirements of the aforementioned standards.

C0089 "Certified" triple mold for 40 x 40 x 160 mm specimens

Made of treated and ground steel, fully dismountable, with hardness in excess of 400 HV. All components are marked with an identification number to facilitate assembly. Each mold is individually verified with calibrated instruments to certify hardness, perpendicularity, flatness and roughness, and are engraved with a unique serial number.

Dimensions: 290 x 195 x 50 mm.

Weight: 8 kg.

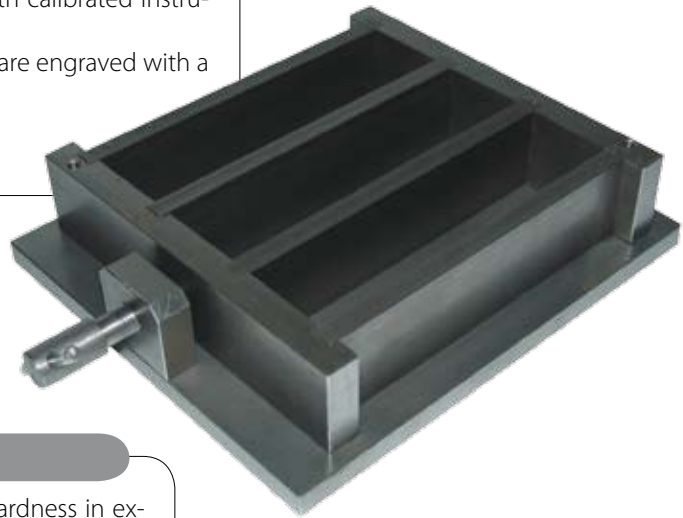

C0090 Triple mold for 40 x 40 x 160 mm specimens

Made of treated and ground steel, fully dismountable, with hardness in excess of 200 HV. All components are marked with an identification number to facilitate assembly. The surfaces are polished to fulfil a tolerance of 0.1 mm as specified in the standard.

Dimensions: 290 x 195 x 50 mm.

Weight: 8 kg.

Accessories:

C0089/1 Glass sheet measuring 200 x 200 mm to cover the mold.

C0091 Aluminium filling hopper.

C0092 Set of EN 196/1 spatulas for levelling the molds.

C0092/1 300mm Leveller.

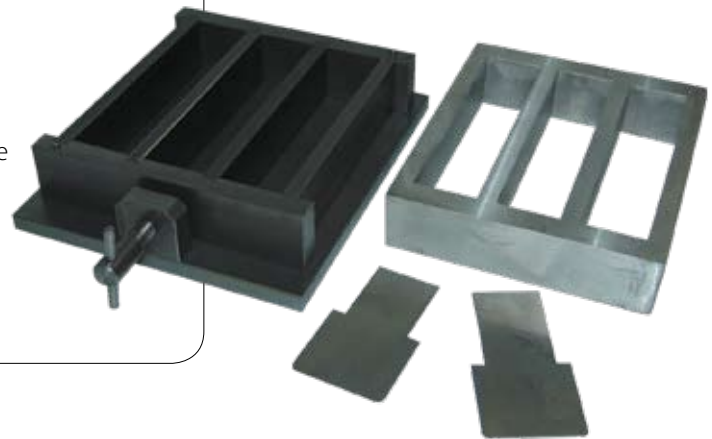

Standards ASTM C109; AASHTO T132

C0095 Triple mold for 50x50x50 mm samples

Made of treated and ground steel, fully dismountable, with hardness in excess of 200 HV. All components are marked with an identification number to facilitate assembly.

Dimensions: 120 x 215 x 60 mm.

Weight: 5.5 kg.



Standards NF P18-401

C0097 Triple mold for 70 x 70 x 280 mm specimens

Made of treated and ground steel, fully dismountable, with hardness in excess of 200 HV.

Weight: 5.5 kg

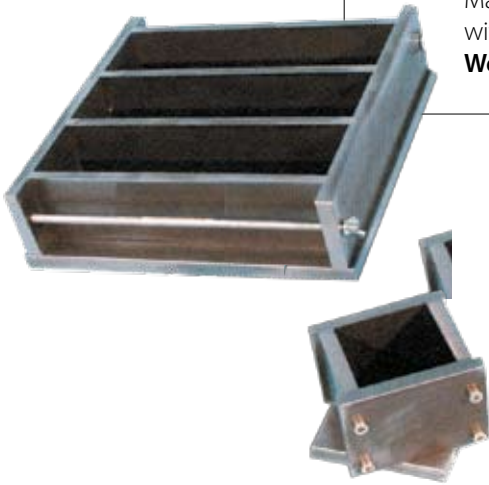

Standards BS 4550

C0096 Cubic mold for 70.7mm samples

Made of treated and ground steel, fully dismountable, with hardness in excess of 200 HV.

Dimensions: 100 x 100 x 90 mm.

Weight: 3 kg.

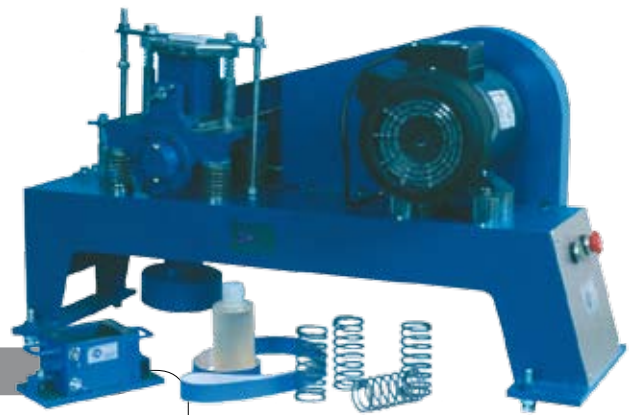

C0098 Vibrating machine for 70.7 mm molds

Designed to prepare cubic mortar specimens measuring 70.7 mm per side. The mold platform is mounted on four springs joined to an eccentric shaft that vibrates the samples at 12000 cycles/min according to technical specifications.

Power supply: 1x 220-240 V. / 50 Hz. 250 W.

Dimensions: 950 x 330 x 550 mm.

Weight: 95 kg.

Standards EN 196/1; NF P15-413; ISO 679; BS 3892; D.M. 3/6/68

C0100 Automatic mortar compactor

Automatic compactor for samples measuring 40 x 40 x 160 mm. Fastening system for easy mold placement and removal. Supplied complete with automatic preselector and digital display of the number of impacts, emergency stop button and connection cable.

Power supply: 1 x 220/240 V. 50 Hz.

Dimensions: 980 x 280 x 400 mm.

Weight: 60 kg.

Accessories:

C0090 Triple mold for 40 x 40 x 160 mm mortar specimens.

C0091 Aluminium filling hopper, 40 x 40 x 160 mm.

C0092 Set of spatulas (2), to level the mold.

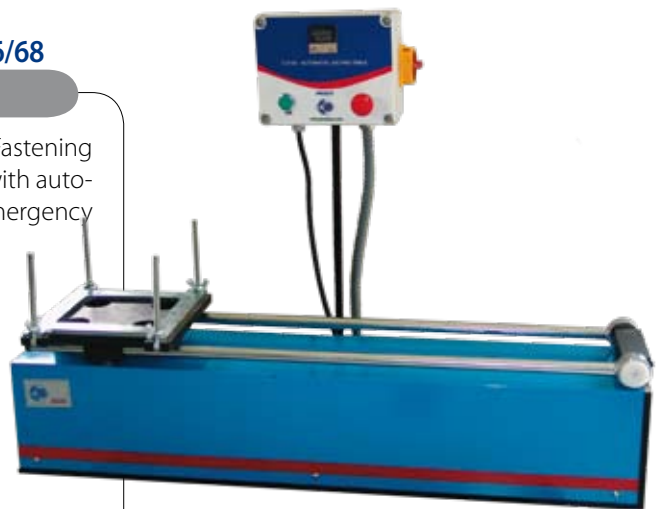

Sample curing

Standards EN 196/1; ISO 679

Standard EN 196 states that prior to the test, the specimens must be cured for at least 24 hours at $20 \pm 1^\circ\text{C}$ and 90% RH. The specimens must then be removed from the molds and submerged in

water for the required curing time, generally 48 hours, 72 hours, 7 and 28 days.

C0105 Water bath for curing mortar specimens

Made of metal with a double body. Includes an immersion thermostat and resistance elements shielded in stainless steel, an electronic temperature control system, programming, digital display and visible alarm in the event of overtemperature. Supplied complete with rack with capacity for 40 specimens measuring $40 \times 40 \times 160$ mm.

Temperature control range: ambient to 100°C .

Power: 220 V. / 50 Hz.

Dimensions: $300 \times 500 \times 200$ mm.

Accessories:

C0105/1 Immersion cooler of up -10°C .



Standards EN 196/1; ASTM C87, C109, C190, C191; UNE 80102

C0106 Large curing cabinet

Designed to cure large amounts of mortar and concrete samples. Made of aluminium and polycarbonate, complete with a resistance element heating system, digital precision thermostat and four sample trays. Saturated humidity conditions are achieved inside the chamber by water nebulisers activated by an air compressor (optional).

Range of humidity: 95% to saturation.

Range of temperature: ambient to $+30^\circ\text{C}$.

Accuracy: $\pm 1^\circ\text{C}$.

Internal dimensions: $1090 \times 470 \times 1200$ mm.

External dimensions: $1370 \times 540 \times 1490$ mm.

Power supply: $1 \times 220-240$ V / 50 Hz. 2000 W.

Weight: 100 kg.

Accessories:

C0105/1 Immersion cooler, for temperatures between ambient temperature and -10°C .

C0105/3 Air compressor.



Determining cement strength

Standards EN 196/1; ASTM C109; BS 3892; DIN 1164; NF P18-411; AS 2350

These machines have been studied and designed to test cement prisms measuring 40 x 40 x 160 mm for both bending and compression strength.

Proeti offers several versions, depending on the capacity and degree of sophistication of the machine required. All the machines include an electrical cutoff system that stops the test automatically when rupture is detected.

Semi-automatic versions require little operator intervention in order to perform the test. These models are equipped with a hydraulic motor pump to operate at low pressures with highly accurate results. They also include a manual two-stroke valve for fast piston approach and automatic change to ensure the required pressure for the test, thus avoiding time losses.

Automatic servo-hydraulic version: These machines perform the test automatically at the touch of a button. This range includes an extremely silent servo-controlled hydraulic unit, which contains a pump that accurately regulates the oil flow that activates the piston, thus controlling the rotation speed of the mo-

tor pump unit. This system guarantees reliability, accurate results and high levels of precision.

Multi-test electro-mechanical servo-controlled version: These models are equipped with a direct current servo-motor, a gearbox, transmission belt, ball screws, stroke transducer, speed setting and various electrical control and safety mechanisms. They are so versatile that they are used in most standard tests at restricted speeds, for bending, compression and tensile strength (see soil section).

Fulfilling safety requirements and in compliance with standard EC 89/392, the test area includes a protection system that protects the operator against possible pieces of specimen which may be ejected during the test.

General Characteristics

Test frame that guarantees high level of stability.

Easy to use and maintain, designed for continuous use.

Designed in accordance with the specifications of International Standards EN, ASTM, AASHTO, BS, UNE, DIN, NF.

Single or double chassis versions.

Round, tempered and ground compression plates in compliance with ISO 6507-1, the top plate has a hinge joint for perfect positioning. 250 kN and 300/15 kN capacity.

Measuring systems with digital display, with a microprocessor or computerised.

Versions with a motor pump with manual load adjustment or automatic servo-control.

All versions are supplied with ENAC Official Calibration Certificate, in compliance with ISO-EN 7500-1.

Models:

C0110 Motor-driven press with 250 kN capacity and H0206/1 digital display



Single body test area, designed to house the corresponding test devices (not included, see accessories).

Maximum compression load capacity: 250 kN.

Force sensor 700 bar, output 2 m/V.

Piston activation via hydraulic motor pump unit with a manual flow or test speed adjustment valve that guarantees superior precision and handling.

H0206/1 digital measurement unit with two-channel microprocessor, including memory, load speed indicator, rupture detector with automatic stop and RS232C output. H0206/1 test software for data collection, data transfer for processing to PC and data viewing on screen in real time.

Accuracy and repeatability: $\pm 1\%$.

Power supply: 220-240 V 1ph 50 Hz 750 W.

Piston stroke: 110 mm.

Bottom plate diameter: 145 mm.

Top plate diameter: 80 mm.

Dimensions: 650 x 430 x 940 mm.

Weight: approx. 190 kg.

C0117 Motor-driven press with double piston test frame of 300/15 kN capacity for compression and bending strength tests.



Double test area for compression and bending strength tests

Maximum compression load capacity: 300 kN with force sensor.

Maximum bending strength capacity: 15 kN, with load cell.

C0116 Bending and C0115 compression devices included.

Top plates with hinged joint seating.

Piston stroke: 110 mm.

Double load range 300 and 15 kN.

Piston activation via hydraulic motor pump unit with a manual flow or test speed adjustment valve that guarantees superior precision and handling. H0206/1 digital measurement unit with microprocessor, including memory, load speed indicator, rupture detector with automatic stop, RS232C output and two selectable measurement channels. H0206/1 test software for data collection, data transfer for processing to PC and data viewing on screen in real time.

Accuracy and repeatability: $\pm 1\%$.

Power supply: 220-240 V 1ph 50 Hz 750 W.

Bottom plate diameters: 145 mm.

Top plate diameters: 80 mm.

Dimensions: 820 x 430 x 940 mm.

Weight: approx. 210 kg.

C0123 Automatic servo-controlled press with double piston test frame of 300/15 kN capacity for compression and bending strength tests.

Double test area for compression and bending strength tests

Maximum compression load capacity: 300 kN with force sensor.

Maximum bending strength capacity: 15 kN, with load cell.

C0116 Bending and C0115 compression devices included.

Top plates with hinged joint seating.

Piston stroke: 110 mm.

Double load range 300 and 15 kN.

Piston activated via servo-controlled hydraulic unit by means of a H0206/PLUS module. This unit is designed to control the machine completely and perform compression and bending strength tests adapted to any standard.

H0206/PLUS digital measuring unit with microprocessor, including memory, load speed indicator, rupture detector with automatic stop, RS232C outputs, four selectable measurement channels and multi-language servo-control software.

Accuracy and repeatability: $\pm 1\%$.

Power supply: 220-240 V 1ph 50 Hz 750 W.

Bottom plate diameters: 145 mm.

Top plate diameters: 80 mm.

Dimensions: 850x460x940 mm.

Weight: approx. 255 kg.



H0206/1 Digital Display Module UDI 14/2

14-bit Microprocessor board.

Backlit alphanumeric LCD display with 9 mm characters.

Two data collection channels for connection to force, pressure or displacement transducers.

Two RS232C outputs for connection to a printer or PC.

Stores data in Excel format. (*.xls)

Measurement units available: N; daN; KN; Kgf; Nm; g; Kg; bar; mbar; Mpa; atm; V; mV; mV/V; mm; μm .

Menu available in 4 languages (Spanish, English, Portuguese and Italian).

Auto tare key (zero).

Peak activation key.

Key to transfer data in real time to a PC or printer.

PROETI UDI16/4 software for test data collection and transfer to a PC for printing or saving.

Power supply: 1X220-240V AC 50/60 Hz 30VA.

Dimensions: 200 x 80 x 130 mm.

Weight: 1 kg.



H0208 Software PROETI UDI16/4

This software can be used to perform the test and view the characteristic test curve for load/time or load/deformation (depending on the configuration of the H0206/1 module) in real time on a PC at the same time. The curve data can be saved in Excel format. The software is supplied separately and only runs on the H0206/1 module.

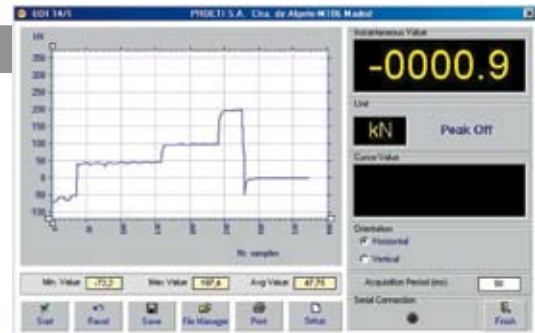

H0206/PLUS Digital Force Display Module with Microprocessor UDI 16/4 PLUS



16-bit microprocessor board.

Back-lit LCD display with 240 x 128 pixel.

Four programmable data collection channels for connection to force, pressure or displacement transducers.

Two RS232C outputs for connection to a printer or PC.

Stores data in Excel format. (*.xls).

Measurement units available: N; daN; KN; Kgf; Nm; g; Kg; bar; mbar; Mpa; atm; V; mV; mV/V; mm; μm .

Menu available in 4 languages (Spanish, English, Portuguese and Italian).

PROETI UDI16/4PLUS software for data/curve collection in real time.

Choice of the specimen area to test.

Choice of degree of load (N/s; Mpa/s; kg/cm²*s) and tolerance \pm % of value entered

User selectable measurement channels.

Automatic calculation of maximum force (Fm), Load

Unitary (Rm), Mean Degree.

Memorisation of data in format

Allows memorised data to be uploaded to a PC in Excel format (.xls).

Power supply: 1X220-240V AC 50/60 Hz 30VA.

Power supply: 220 V. 50/60 Hz.

Dimensions: 230 x 145 x 180 mm.

Weight: 2 kg.



H0209 Software Proeti TCSOft2004Plus

Developed in the Windows XP environment to perform concrete and cement tests on servo-controlled machinery (test performance, calibration, diagnosis, management and data files). Open, interactive design to satisfy a variety of requirements for material testing laboratories in order to perform mechanical strength tests on composite samples, cement, ceramics, etc. in complete compliance with International Standards (EN, UNI, ASTM, ISO). Thanks to its flexibility, the operator can enter a wide range of methods and calculations (even personalised) to perform compression and bending strength tests. The software also provides control diagnostics and direct remote connection with Proeti's Technical Service.

Main characteristics:
Test selection (Compression/Bending).

Automatic or manual setting of the top press bridge using the up/down pushbuttons.

Performs the test according to the selected standard, automatic adjustment of the graphic area during the test performance phase.

Real time display of loads, stroke, extensometer displacement, load/deformation curve with or without the extensometer. Data entry (calculation system, preload, load limits, extensometer stroke, displacement speed, test performance speed, load maintenance, etc).

Speed selection in mm/min, load gradient in N/s.

Selection of automatic piston return at the end of the test and initial test parameter reset.

Limit switch safety management for automatic stopping of movement actuators.

Data file for each curve in .mdb format with ACCESS SQL engine for external preparation.

Create folders.

Search for data using filters.

Create personalised reports.

Print a report at the end of the test with the customer logo, specimen data, notes, results, curve graphs.

Choice of printing the test report three different ways:

- A report of all the tests performed, including customer data, specimen data, notes, results and curve graphs.
- List of test results selected by the operator.
- Report of the test curve graphs selected by the operator in a single graphic area
- Zoom function to analyse the curve when the test is complete and print the area selected on the report.
- Customer logo and information input as the header on test reports



Standards EN 12390-1; EN 196-1

Servo-controlled unit

A hydraulic unit that is servo-controlled by module H0206 Plus or by PC software. This unit was designed to control the machine and the tests completely. The system is capable of performing compression and bending strength tests adapted to any standard. The standard version consists of a unit connected to the loading piston. The machine is controlled by software that manages the tests, prepares graphs and presents the results. The load control system is completely new and emulates a servo-valve using a pump that accurately controls oil flow to the piston, controlling the rpms of the pump motor. This new system developed by Proeti guarantees reliability and productivity, accurate results, repeatability and extreme precision. Another very significant characteristic of this new system is its low level of noise. The unit is extremely quiet.

The complete unit consists of:

PC with Windows XP and 19" TFT monitor or higher.

HP deskjet printer (optional).

High pressure connection tube from the unit to the test frame/piston.

Multilingual servo-control software to perform tests in compliance with EN 12390-3, EN 12390-5 and EN 196-1.

All test data and the rupture curves are saved in *.mdb format to facilitate export to databases (Access, Excel) for custom management by the client.

C0124 Servo-controlled unit.

H0235/6 Compatible PC.

H0209 Control software EN 12390-3, EN 12390-5, EN 196-1.



Accessories:

Devices for compression/bending tests. Placed between the machine plates without the need to use spacer plates to perform the tests.

Standards EN 196/1; ASTM C349; NF P15-451; PR EN/ISO 679

C0115 Devices for compression tests on specimens measuring 40 x 40 x 160 mm

Adapted for compression tests on specimens measuring 40 x 40 x 160 mm. The compression plates are made of special high-strength, ground steel; the top plate has a hinged joint seating.

Dimensions: 140 x 220 mm.

Weight: 8 kg.



Standards ASTM C109

C0115/3 Device for compression tests on cubes measuring 50 mm with 2" sides

Adapted for compression tests on mortar cubes measuring 50 mm with 2" sides.

Weight: 8 kg



C0116 Device for bending tests

Adapted for compression tests on specimens measuring 40 x 40 x 160 mm. The device is placed between the press plates.

Dimensions: 140 x 220 mm

Weight: 8 kg



H0205/4 Stand for Compression/Bending Test Machines

For both concrete or cement at the required working height. Made of painted sheet metal.



H0206/2 Lightweight, small thermal printer.

Paper width: 58 mm.

Printing width: 48 mm.

Interface: RS232.

Dimensions: 147 x 108 x 72 mm.

Weight: 610 g (with battery).

Operating temperature: 0° to 50°C.

Replaceable batteries: NiCd or NiMH.

Standards EN 196; ASTM C190, C348, C349; DIN 1164.

C0120 Motor-driven bending strength scale

Designed to determine the bending strength of mortar specimens measuring 40 x 40 x 160 mm or for bending tests on octoform specimens. The machine is shaped somewhat like a Roman scale; it consists of a solid aluminium body with a graduated horizontal arm, weights and counterweights. Three scales are engraved on the graduated arm. The machine is powered by a motor and ensures a constant load increase of 50 ± 10 N/sec; it can operate automatically without interruption or be controlled by the operator. The machine stops automatically once the specimen is broken, although it includes a limit switch. Accessories must be ordered separately.

Accuracy: $\pm 1\%$.

Power supply: 220-240 V. 50 Hz.

Dimensions: 1000 x 460 x 720 mm.

Weight: 52 kg.



Accessories to use with the C0120:

C0120/1 Clamp for bending strength tests, as per ISO.

C0120/2 Clamp for bending strength tests, as per AFNOR, articulated at four points.

C0120/3 Clamp for bending strength tests as per DIN.

C0120/4 Clamp for bending strength tests as per ASTM.

C0120/5 Clamp for tensile strength tests as per BS and ASTM.

C0120/6 Clamp for tensile strength tests, as per ISO.

C0121 Simple mold, designed for manufacture of octoform specimens (ingots), as per ASTM. Dimensions: 320 x 110 x 400 mm.

Weight: 7 kg.

C0122 Triple mold, designed for producing octoform specimens (ingots), as per ASTM.

Weight: 3 kg.

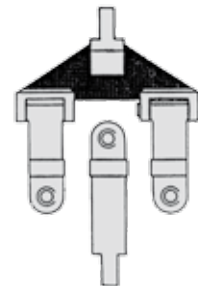
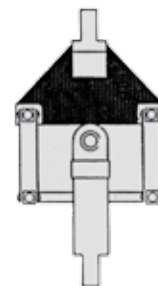
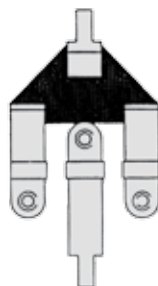

4

CONCRETE

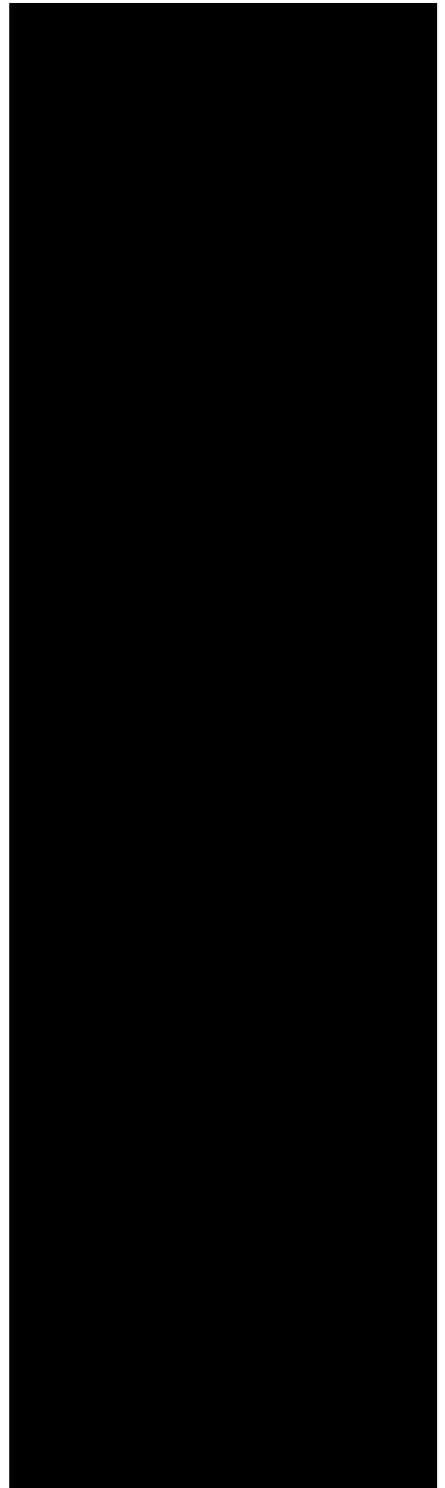

Collecting specimens to test consistency and workability

Standards EN 12350-2; UNE 7103, 83313; ASTM C143; AASHTO T119; BS 1881; DIN 1048; NF P18.305

Strict control of the water-cement ratio and concrete workability is essential to ensure that the concrete attains its maximum strength while remaining easy to pour at the worksite. This is achieved by using the following equipment:

Slump Cone Set

H0001 Slump cone, made of galvanised sheet metal, designed to measure concrete cohesiveness.

Weight: 1.8 Kg

H0002 Rod, made of galvanised steel.

Dimensions: Ø 16 x 600 mm

Weight: 1 Kg

H0003 Cone-filling hopper. Made of aluminium.

H0004 Base plate made of galvanised sheet metal, with a handle.

Dimensions: 60 x 40 cm

Weight: 3 Kg

H0004/2 Base plate measuring 1000x1000 mm with two concentric circles of 200 mm and 500 mm.

H0005 Graduated stainless steel ruler.

Length: 300 mm



Tests for self-compacting concrete

Standards EN 12350-2; RILEM REPORT No.23

Slump flow test

This test method is used to determine the deformability of freshly mixed self-compacting concrete. The deformation speed must be observed, as well as the expanded diameter of the specimen, deformed under its own weight. This test method is used for high fluidity concrete made with super plasticisers. It should not be used for concrete made of aggregate larger than 40 mm

Basic equipment

H0001/1 Cone with interior Ø 200 mm at the base, 100 mm at the top and 300 mm high. No legs

H0004/3 Square seating plate made of non-absorbent material, measuring 800 x 800 mm with two handles and two concentric circles of 200 mm and 500 mm

V0070 Stop watch.

V0047 Curved specimen collector.

V0161 Flexible ruler 1000 mm long

S0254/1 Bevelled screed with handles.

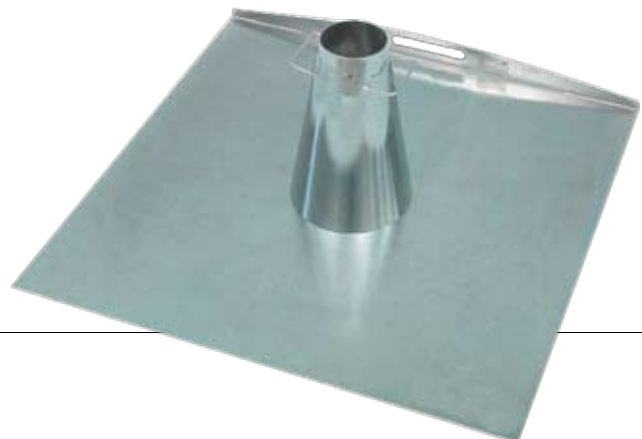



Standards EN 12350-9

"V" funnel test

This apparatus is used to calculate the segregation resistance of freshly mixed self-compacting concrete by observing the flow rate and the length of time that the specimens remain in the funnel. It consists of a stainless steel funnel placed vertically on a support base. The outflow orifice has a cover that can be opened at any time.

Basic equipment

V0070 Stop watch.

V0047 Curved specimen collector

H0010/1 Rigid ruler 900 mm long

S0254/1 Bevelled screed with handles

H0010 V funnel made of sheet metal with a capacity of 10 L, equipped with a seal valve for the outflow orifice

H0010/2 Polyethylene box of approx. 12 L

Approximate weight: 5.6 Kg

Standards EN 12350-10

"L" box test

This method is used to evaluate the self-compactability (confined fluidity) of freshly mixed self-compacting concrete. The "L" box can be used to evaluate several properties, such as filling capacity and segregation resistance.

Basic equipment

V0070 Stop watch.

V0047 Curved specimen collector.

S0254/1 Bevelled screed with handles.

H0011/1 Rectangular ruler 300 mm long

H0011 L box made of sheet metal consisting of:

A container with reinforced interior

A shutter consisting of three vertical bars 16 mm long and a 38 mm span

Front closing trap door.

Two marks at 200 and 400 mm, in the horizontal position of the box.

Approximate weight: 18.2 Kg



Standards EN 12350-12

"J" ring test

This method is used to determine the fluidity, the flow time and the capacity of the SCC to pass through obstacles. Made of galvanised steel with a diameter of 300 mm and 16 simple rods with a diameter of 18 mm.

Approximate weight: 10 Kg

H0013 "J" ring



"U" box test

This method is used to find the confined fluidity and the capacity of SCC to flow in confined spaces. Made of galvanised steel with a frame made of four 10 mm diameter bars and three 13 mm diameter bars.

Approximate weight: 25 Kg

H0009 "U" box

H0011/1 Rectangular ruler 300 mm long



Standards BS 1881 part 103, 5075
H0012 Compaction factor equipment

This equipment is used to determine the compaction factor for concrete with low, medium and high workability. The apparatus is manufactured in painted steel plate and consists of two cone-shaped hoppers with discharge doors assembled vertically on a cylindrical container.

Dimensions: 1310 x 250 x 400 mm

Weight: 40 Kg

Standards EN 12350-3; UNE 83.314; NLT -308; BS 1881:104
H0014 Vebe consistometer

This apparatus is used to determine the degree of consistency or "Vebe degree" of concrete. It consists of a vibrating table at the bottom of which are mounted a vibrator, a container, a cone, a funnel, a transparent plastic disc and a steel tamper with a round end.

Power supply: 380 V. 50-60 Hz.

Weight : 80 Kg

Dimensions: 450 x 450 x 900 mm

Standards EN 12350-4; DIN 1048
H0015 Walz Consistometer

Used to determine the consistency of fresh concrete. The unit consists of a metal container with handles, measuring 200 x 200 mm on each side and 400 mm high, oven-painted.

Weight: 6 Kg

Standards EN 12350-5; BS 1881-105; DIN 1048
H0016 Expansion test table

This equipment is appropriate for testing concrete mixes with high and very high workability. It consists of a double square wooden table measuring 70 cm per side, with a galvanized sheet metal top, and one of the bottom sides fitted with hinges. A galvanized sheet metal cone measuring \varnothing 130/200 x 200 mm is located on the middle of the table. The test consists of introducing the concrete through the cone and stirring it. Then, the top of the table is lifted and lowered 15 times in 15 seconds to a height of 4 cm. Finally, the concrete that has spread on the table is measured and its workability is evaluated. The equipment is supplied with the cone and a wooden tamper.

Cone dimensions: 130 x 200 x 200 mm

Table dimensions: 700 x 700 x 330 mm

Spare parts:

H0016/1 Cone-shaped mould measuring \varnothing 130/200 x 200 mm h.

H0016/2 Wooden tamper. Weight: 20 Kg

Standards ASTM C360

H0017 Kelly ball penetrometer

This device is used as an alternative to the Abrams Cone to determine fresh concrete plasticity or workability. The apparatus consists of a cylindrical weight that weighs 14 Kg, a stirrup and a graduated handle. The readings correspond to double the value of the readings with an Abrams Cone.

Dimensions: 350 x 150 x 350 mm

Weight: 15 Kg



Standards UNE 13748-1

H0018 Apparatus for testing tile impact resistance

This apparatus consists of a magnetic device that releases a steel sphere with 1 Kg of impact energy, a graduated bar to set the height of the fall and a box at the bottom measuring 50 x 50 cm with a centring device on which the sand is placed to set the test tile.

Dimensions: 800 x 870 x 1327 mm

Weight: 65 Kg

Spare parts

H0018/1 Steel ball 1Kg.



Standards ASTM C1362

H0020 K-Slump test

This test is used to determine the degree of compaction and workability of fresh concrete.

Height: 300 mm

Point diameter: 20 mm

Weight: 0.5 Kg



Standards ASTM C 403; AASHTO T 197

H0021 Concrete pocket penetrometer

Used to determine the setting time of concrete. The test consists of introducing the point of the penetrometer at regular intervals into the concrete to a depth of 25 mm. Concrete strength expressed in Mpa is indicated by a ring on the penetrometer scale.

Weight: 500 g

Dimensions: Ø 30 x 220 mm

Point surface: 32 mm



Standards UNE 83.311; ASTM C 403; AASHTO T 197
H0022 Concrete penetrometer

This device is used to determine the time during which the concrete can be handled. It is supplied with a carrying case, and includes a set of exchangeable points with the following sections: 16, 32, 65, 160, 325 and 650 mm² and an adaptor for small points.

Applicable force: 70 Kg

Dimensions: 440 x 360 x 100 mm

Weight: 4 Kg

Standards NF P18-452
H0025 LCL Plasticimeter

This is used to verify how homogeneous a fresh concrete mix is, depending on its workability, specifically in the case of concrete containing additives. The unit consists of a small rectangular container divided by a removable separator and a vibrator coupled to one of the walls of the container. The test consists of introducing the fresh concrete into the first compartment and removing the spacer that divides the container. This automatically activates the vibrator; the test ends by recording the vibration time required for the specimen to spread homogeneously over the second compartment.

Power supply: 220-240 V. 50 Hz.

Dimensions: 820 x 420 x 410 mm

Weight: 95 Kg

Standard LCPC (French Public Works Research Laboratory) method
H0026 Joisel apparatus

This apparatus is used to separate the various elements that form concrete in order to assess their proportions individually with an accuracy of 2%. The equipment consists of three stainless steel containers.

Dimensions: Ø 150 x 250 mm

Weight: 2 Kg.



Standards UNE EN 12350-5; ASTM C124; AASHTO T120

H0027 Motor-driven vibrating table

This device is used to determine the fluidity of fresh concrete. It is made up of a round table measuring \varnothing 762 mm resting on a base. It is supplied with a mould, a brass tamper with a wooden handle, an impact counter and main switch.

Dimensions: \varnothing 762 x 600 mm

Weight: 90 Kg

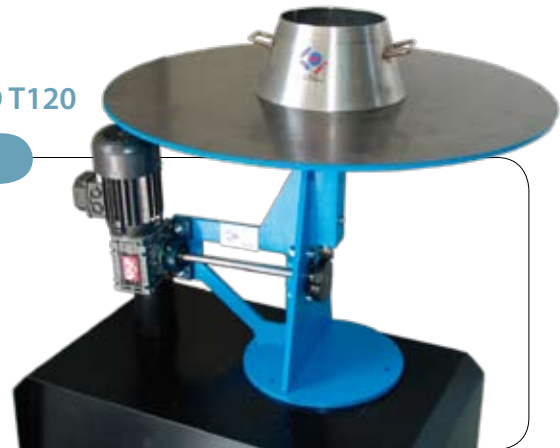

H0028 Manual vibrating table

This device is used to determine the fluidity of fresh concrete. It is made up of a round table measuring \varnothing 762 mm resting on a base. It is supplied with a mould and a brass tamper with a wooden handle.

Dimensions: \varnothing 762 x 600 mm

Weight: 75 Kg

Specific weight

Standards UNE EN 12350-6; UNE 7286, 83.317; ASTM C29, C138; BS 812, 1881, AASHTO T19

Calibrated volumetric containers

These containers are used to determine weight per cubic metre of fresh concrete. They are made from painted steel sheeting.

Models:

- H0030** 0.5 litre container
- H0031** 1 litre container
- H0032** 2 litre container
- H0033** 3 litre container
- H0034** 5 litre container
- H0035** 10 litre container
- H0036** 14 litre container
- H0037** 28 litre container



Air entrainment in fresh concrete

Standards EN 12350-7; UNE 7141, ASTM C231: BS 1881-106; DIN 1048

Trapped air can be defined as the amount of air that has been introduced into the concrete by airborne agents for particular reasons, in addition to the air already present in the concrete. The main advantages from the use of the trapped air meter are as follows: ice resistance, suitability for a wide range of weather conditions, durability and improved workability. The amount of trapped air should be accurately controlled by specific equipment since excessive air can cause loss of strength.

Air entrainment meters

H0046 Air entrainment meter. This device is designed to determine the amount of air contained in the concrete. The device is made of aluminium and includes a manual pressure pump connected to a pressure gauge.

Volume: 8 litres.

Pressure: 2 bar

Dimensions: Ø 250 x 450 mm

Weight: 12 Kg



H0046 Air entrainment meter. This device is designed to determine the amount of air contained in the concrete. This device is made of a light alloy and supplied with a manual pump.

Volume: 5 litres.

Pressure: 2 bar.

Dimensions: Ø 340 x 630 mm

Weight: 11 Kg



H0046 Electric air entrainment meter. This device is designed to determine the amount of air contained in the concrete. It consists of an 8 L tank, sealed with a lid with three hooks. The compression chamber inside the lid is connected to an electric mini-compressor and a loading electrovalve used to increase the pressure. Each of these components is activated by its corresponding push button. The electric mini-compressor generates pressure quickly and keeps it constant.

Volume: 8 litres.

Measurable air content: 0-100%.

Power supply: Single phase 220-240 V. 50 Hz.

Weight: 18 Kg

Accessories:

H0047/1 Calibration cylinder



H0049 Air in concrete meter. This device is ideal for "in situ" verification of the air content in each fresh concrete mix. The meter is 160 mm long and isopropyl alcohol must be used in carrying out the test.

Weight: 1.8 Kg

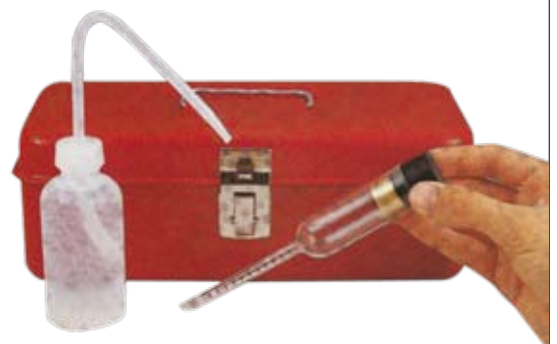

Specimen preparation

Standards EN 12390-2

Mixing

The purpose of mixing is to cover the surface of the aggregate particles with cement paste to obtain a uniform mixture. Rotating drum mixers are ideal to mix the small amounts of concrete normally used in a laboratory.

ETI concrete mixers

These mixers have been designed and built for specific use in official laboratories, institutions and universities. They are indispensable for obtaining a perfect mix of concrete and guaranteeing a high degree of homogeneity. Due to the considerable size of the vessel, models with capacity over 50 L are supplied with a cart for transportation and safety protection. Power supply: 220/380 V. 50-60 Hz.

Models

H0050 Laboratory mixer, holds 14 litres. Dimensions: 700 x 600 x 650 mm Weight: 80 Kg

H0051 Laboratory mixer, holds 50 litres. Dimensions: 780 x 700 x 800 mm Weight: 160 Kg

H0052 Laboratory mixer, holds 100 litres. Dimensions: 830 x 800 x 900 mm Weight: 200 Kg

H0053 Laboratory mixer, holds 150 litres. Dimensions: 1700 x 950 x 1180 mm Weight: 290 Kg

H0056 Small, light weight concrete mixer, designed to produce small amounts of concrete "in situ" or in a laboratory. Easy to handle and transport.

Capacity: 100 litres.

Dimensions: 770 x 1320 x 1370 mm

Weight: 55 Kg



Specimen preparation

Standards UNE EN 12390-1; UNE EN 12390-2; UNE 7240; DIN 51.229; ASTM C31, C192; AASHTO T23, T97; BS 1881-108; NF 18-401

Test procedures need specimens to be manufactured in standard sizes that are convenient for determining their compression and flexural strengths. The specific industrial tolerances for mould manufacture are very strict and require interior finish to be of high quality to meet the requirements of a number of international standards. The moulds must not undergo deformation during specimen manufacture.

Moulds for specimen preparation

Cubic moulds

For the preparation of concrete specimens. Made of undeformable steel and easy to disassemble.

Models:

- H0060** Dimensions 10 x 10 x 10 cm Weight: 10 Kg
- H0061** Dimensions 15 x 15 x 15 cm Weight: 13 Kg
- H0062** Dimensions 20 x 20 x 20 cm Weight: 16 Kg
- H0063** Dimensions 30 x 30 x 30 cm Weight: 20 Kg
- H0064** Dimensions 6" x 6" x 6". Weight: 14 Kg
- H0065** Dimensions 50 x 50 x 50 cm Weight: 46 Kg



Three-gang moulds

For the preparation of concrete specimens. Made of undeformable steel and easy to disassemble.

Models:

- H0070** Dimensions 10 x 10 x 10 cm Weight: 25 Kg
- H0071** Dimensions 20 x 20 x 20 cm Weight: 35 Kg
- H0072** Dimensions 30 x 30 x 30 cm Weight: 45 Kg
- H0073** Dimensions 15 x 15 x 15 cm Weight: 30 Kg
- H0074** Dimensions 6" x 6" x 6". Weight: 32 Kg



Cubic moulds

For the preparation of concrete specimens. Made of epoxy material and easy to disassemble.

Models:

- H0080** Dimensions 10 x 10 x 10 cm Weight: 1 Kg
- H0081** Dimensions 15 x 15 x 15 cm Weight: 1.5 Kg
- H0082** Dimensions 20 x 20 x 20 cm Weight: 3.5 Kg

Accessories:

- H0080/1** Filling hopper for 10 cm cubic mould
- H0081/1** Filling hopper for 15 cm cubic mould
- H0082/1** Filling hopper for 20 cm cubic mould



Moulds for specimen preparation

Prism moulds

For the preparation of concrete specimens. Made of undeformable steel and easy to disassemble.

Models:

- H0085** Dimensions 10 x 10 x 40 cm Weight: 20 Kg
- H0086** Dimensions 10 x 10 x 50 cm Weight: 27 Kg
- H0087** Dimensions 15 x 15 x 60 cm Weight: 45 Kg
- H0088** Dimensions 15 x 15 x 75 cm Weight: 60 Kg
- H0089** Dimensions 20 x 20 x 80 cm Weight: 90 Kg
- H0090** Dimensions 6" x 6" x 18". Weight: 30 Kg
- H0091** Dimensions 6" x 6" x 21". Weight: 35 Kg
- H0092** Dimensions 6" x 6" x 24". Weight: 46 Kg
- H0093** Dimensions 6" x 6" x 30". Weight: 60 Kg
- H0094** Dimensions 6" x 6" x 36". Weight: 75 Kg
- H0095** Dimensions 6" x 6" x 40". Weight: 140 Kg



Cylinder moulds

Hinged, made of stamped steel for the manufacture of cylinder moulds.

Models

- H0100** Dimensions Ø 100 x 200 mm Weight: 7 Kg
- H0101** Dimensions Ø 150 x 150 mm Weight: 8 Kg
- H0102** Dimensions Ø 150 x 300 mm Weight: 9.5 Kg
- H0103** Dimensions Ø 160 x 320 mm Weight: 10.2 Kg



Accessories

- H0102/1** Filling hopper for Ø 150 x 300 mm mould
- H0102/2** Compaction rod. 50 cm long

H0105 Cylinder mould for the preparation of Ø 150 x 300 mm specimens made of epoxy material, easy to disassemble.

Accessory

- H0105/1** Filling hopper

H0102C Calibrated cylinder mould measuring Ø 150x300 mm, in compliance with specifications EN-UNE 12.390-1 section 5.2.5 including a calibration certificate with ENAC traceability.



Compaction

Standards UNE EN 12390-2; ASTM C31, C 192; AASHTO T23, T126; BS 1881:108

When preparing the concrete specimens, it is extremely important that the distribution be homogeneous and as compact as possible. PROETI offers several compaction methods:

H0110 Vibrating laboratory table

To vibrate cubic and cylindrical specimens.

Vibration frequency: 3,000 rpm

Dimensions: 600 x 400 x 410 mm

Power supply: 220-380 V. 50/60 Hz.

Weight: 65 Kg



H0111 One-way vibrating table

Equipped with two vibrating tables placed at a distance from each other, that ensure one-way movement of the aggregates contained in the mix.

Vibration power: 120-260 Kw

Vibration frequency: 3000 rpm

Power supply: 220-380 V. 50/60 Hz.

Dimensions: 1170 x 550 x 500 mm

Weight: 108 Kg

Accessory

H0112 Cylinder mould anchoring device.

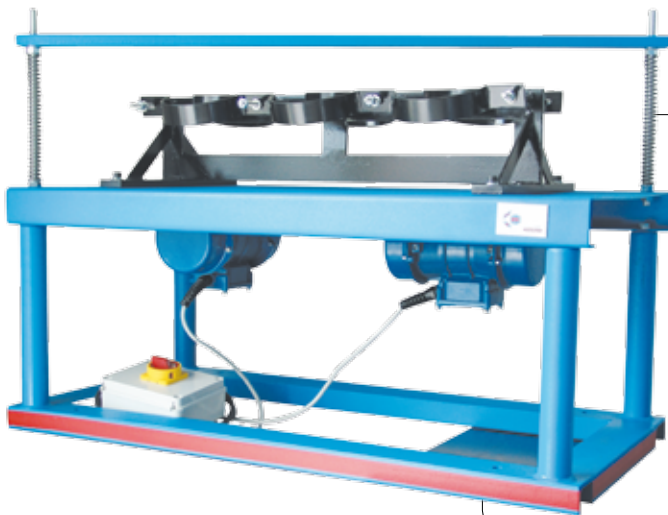

H0115 Needle vibrator

With double insulated electric motor, very useful for vibrating the concrete in the mould.

Needle diameter: 22 mm

Cable length: 1.5 m.

Dimensions: 220 x 70 x 630 mm

Power supply: 220 V. / 50 Hz.

Weight: 3 Kg



H0116 Needle vibrator

With internal combustion engine, used to vibrate concrete in the mould.

Needle diameter: 22 mm

Cable length: 1.5 m.

Power supply: 220 V. / 50 Hz.

Weight: 3 Kg



Specimen curing

Standards UNE EN 12390-2; EN 196; AASHTO T23; ASTM C31, C192; BS 1881-111

Curing is an important step in performing tests on concrete specimens. This stage includes the time period from specimen preparation to the beginning of test operations. There are several types of curing procedures available, depending on the purpose of the test; one of these is curing under specific humidity and temperature conditions. In order to control the concrete mix, the specimens must be held at a temperature of $20 \pm 2^\circ \text{C}$ and relative humidity equal to or higher than 95%. The equipment installed by PROETI satisfies the requirements of the specifications that govern the curing process.

H0120 Water bath for curing concrete specimens

Made of galvanized sheet metal, designed for curing both cubic and cylindrical concrete specimens. The equipment is supplied with thermostatically controlled heating elements and a bottom support tray under which the heating element, water inlet and draining tube are placed.

Standard dimensions: 1500 x 750 x 750 mm

Weight: 120 Kg

Spare parts:

H0120/1 Thermostatically controlled heating element.

H0120/2 Heating element cover tray



H0121 Thick plastic curing tank

The tank holds 650 litres and is used for curing and storing concrete specimens. It is made of high-strength polyethylene. The tank is fitted with a grille. Accessories that are not included but can be ordered are a thermostat and submersible circulation pump.

Internal dimensions: 1040 x 1040 x 605 mm

External dimensions: 1130 x 1130 x 760 mm

Capacity: 650 litres.

Weight: 30 Kg

Accessories:

H0121/1 Analogue thermostat with heating system.

H0121/2 Digital thermostat with heating system.

H0121/3 Plastic lid for H0121 tank.

H0121/4 submersible circulation pump.



Standards ASTM C684, BS 1881-112
H0122 Rapid curing tank

The tank is airtight, made of oven-painted galvanized steel plate with a stainless steel lid. Water temperature is maintained constant at the preset level by means of a set of resistors placed at the bottom of the bath. The control panel includes a main switch, On/Off push buttons, a timer that can be programmed between 0 and 12 h, a thermoregulator that can be programmed between 30-100°C, a thermostat and switches for the resistors. The tank can hold up to 8 specimens with sides measuring 200 mm or 16 cubic specimens with sides measuring 150 mm or 16 cylindrical specimens measuring Ø 150 mm

Power supply: 220-380 V. 50/60 Hz. 4500 W.

Internal dimensions: 910 x 660 x 680 mm

Weight: 135 Kg

Accessories:

H0122/1 Set of two resistors with a thermostat for specimen curing water baths.

Standards UNE EN 12390-2; EN 196; ASTM C31, C192;
Temperature and humidity control for concrete specimen curing chambers
H0125 Control panel. Including:

- Metal console / machined cabinet.
- Programmable PLC to control 2 channels (humidity and temperature), with digital display.
- 1 set of two PT100 probes for humidity + temperature
- Handling, control and connection elements.

H0127 Heating / cooling equipment. Including:

- Air cooled condensation unit.
- Incorporated heating unit.
- HDN-10N2 ceiling-mounted evaporator
- TEX expansion valve.
- Liquid visor 8" KAP
- KAP163 dehydrator.

DANFOSS KP15 high and low pressure cut-off switch



Humidifying systems

H0129 Humidifier. Sturdy, aesthetic compact sprayer for locations or chambers used for curing specimens, of up to 150 m³. Generates a very fine drop-free aerosol mist. Maintenance-free condensation motor equipped with built-in thermal overload switch. Easy to clean. Low power consumption, for use anywhere

Technical characteristics

Automatic control connected to the water mains and a level adjustment valve.

Humidifying capacity: 0.5 L / h

Calculated air volume: 80 m³ / h

Water tank capacity: 5 L.

Absorbed power: 40 W

Dimensions: Ø 360 x 23 mm (h)

Dry weight: 3.5 Kg

Power supply voltage: 110/220 V; 50 Hz



H0129/1 Humidifying with a nebulizer system including a distribution line of nebulizers connected to the water intake inside the chamber.

Electrovalve system to turn the water supply to the circuit of nebulizers on and off.

220 V / 12 V transformer system to power the electrovalve.



H0130 Humidifier similar to model H0129 but with a humidifying volume of 400 m³.

Capacity: 0.5 - 3.5 L/h.

Data storage system

H0126 Data acquisition system (temperature / humidity) to PC. PLC encoding and configuration and a completely integrated humidity / temperature system. The stored data can be accessed in-situ, by the printer or analysed in the PC. The software is in Spanish and multi-language, output RS232.

V0156 Electronic thermohygrograph data logger. A compact instrument with an integrated humidity / temperature probe that can be installed quickly and directly in-situ. The stored data can be accessed in-situ using the printer or analysed in the PC using the software. It is supplied with an optional sintered head for protection against dusty environments. RS232 interface. Software in Spanish (for Windows).

Technical data:

Probe type: NTC capacitive humidity sensor

Range:

Humidity: 0 100% RH

Temperature: - 10 °C..... + 50 °C

Resolution:

Humidity: 0.1 % RH (0..... + 100 RH)

Temperature: 0.1 °C (- 10 ...+50 °C)

Accuracy:

Humidity: ± 3% HR (+ 2 ... 98% RH)

Temperature: ± 0.4 °C (- 10 ..+ 50 °C)

Memory: 20000 readings

Measuring cycle: 2 s to 24 hours, programmable

Made of anodised aluminium

Operating temperature: - 20 °C + 70 °C.

Storage temperature: - 40 °C + 85 °C

Lithium batteries

Dimensions: 13 x 68 x 84 mm

Weight: 320 g

The equipment is supplied with a magnet, battery, software with interface and a calibration report.



V0156/2 Teflon sintered head. Ø 21 mm, can be threaded to a humidity probe. Protection for heavy mechanical loads and high speeds.

Optional

V0156/3 Digital display to connect to the data logger.

H0123 Partitionable chamber for curing concrete specimens

A partitionable chamber for curing specimens with self-supporting panels, consisting of a nucleus of injected polyurethane with a density of 40 Kg/m³ and covered with 80 mm thick, pre-lacquered steel plate on both sides. Pivoting door leaf injected with high density polyurethane. Double frame for panel assembly. Lacquered sheet metal finish. Stainless steel fastenings. Wide enough for carts.

Door dimensions: 1200 mm x 2200 mm

Chamber dimensions

3600 mm long

2000 mm wide

2500 mm high

Approximate specimen capacity 600

H0123/1 Shelves

Manufactured in galvanized steel, with height-adjustable shelves every 330 mm

The maximum load distributed uniformly on each level is 640 Kg for shelves measuring 1200 mm (length) X 500 mm (depth) and 530 Kg for shelves measuring 1500 mm (length) x 500 mm (depth). Protected against humidity.



Standards UNE EN 1367-1; UNE EN 10345-12

Freeze-thaw test

H0133 Environmental chamber for the freeze/thaw test

Thermostatic climate cabinet, designed for cold and heat testing of any kind of material.

Temperature range: $-20 + 80^{\circ}\text{C} \pm 5^{\circ}\text{C}$.

Humidity: 10 - 90% RH.

Interior made of stainless steel.

Exterior made of stainless steel, fine satin finish.

Internal forced air ventilation.

Useful capacity: 520 litres.

Internal dimensions: 620 x 630 x 1390 mm

External dimensions: 730 x 1000 x 2090 mm

Complete with height-adjustable trays.

Power supply: 220 V. / 50 Hz.

**Accessory**

H0134 Graphic humidity and temperature recorder.

V0200 Freezer chest

Freezer chests with a static evaporating system are attractive options for tests that do not require strict homogeneous results greater than $\pm 3^{\circ}\text{C}$ or where the specimens suffer degradation as a result of the forced air. These are used in tests where the cooling speed is very slow or for long term stability tests performed at constant set point. Maximum energy savings and minimum noise level. Easy-to-open lightweight access door.

Useful Volume: 200 litres.

Temperature range: room temperature to -40°C

Internal dimensions: 660 x 790 x 450 mm

**V0200/A Monoblock freezer chest with forced air cooling and electronic-digital temperature control**

Forced air freezer chests are especially designed to fast freeze liquids and for thermal fatigue studies in construction materials, plastic and rubber. Other than their air circulation design, their great advantages versus static evaporation freezers are their fast-freeze speed and excellent temperature recovery features.

Useful internal volume: 1,000 litres

Temperature range: room temperature to -25°C

Internal dimensions: 800 x 1830 x 700 mm

External dimensions: 1250 x 2750 x 900 mm



Specimen removal

Standards EN 12504-1

The most direct method of evaluating hardness of construction materials such as concrete is to remove a specimen from the area to be tested. The corer provides a fast, simple way to obtain suitably-sized quality specimens.

H0138 Electric Core Drilling Machine

Three speeds, 360° rotation to work at any angle. The steel base holds a column equipped with an adjustable fastening device. The machine has two wheels that make it extremely manageable, and four legs for lifting and positioning. The column includes a guide that is needed both to move the motor /core unit and to remove the unit. Unit movements are controlled by a handle. The motor includes a rapid connector system to cool the bit. Extensions can be attached to the vertical column to increase the depth to 2.7 m.

Power supply: 220-240 V. 50 Hz.

Absorbed power: 2000 W

Dimensions: 700 x 450 x 1200 mm

Weight: 100 Kg



H0139 Core Drilling Machine, petrol engine

Especially recommended for mobile laboratories and highway testing. Powered by a 4-stroke petrol combustion engine, mounted on a wheeled base. The machine head moves between two columns by means of a spindle. Supplied with a water-cooling device.

Motor power: 5 Hp.

Dimensions: 800 x 580 x 1230 mm

Weight: 150 Kg

Diamond crown bits:

H0141 Ø 50 x 350 mm

H0142 Ø 75 x 350 mm

H0143 Ø 100 x 350 mm

H0144 Ø 150 x 350 mm

H0145 Ø 200 x 350 mm

H0146 Extension for diamond crown bits. 500 mm long



Specimen cutting and grinding

For large concrete blocks taken from structures or obtained using a corer, a preliminary set of tasks must be carried out to prepare the specimen so that it complies with the required standard

Specimen cutting devices

These cutting devices are suitable for concrete specimens and construction components. Includes a device for cutting specimens obtained by corers as well as irregular rock specimens. Supplied with disc protection and a submersible pump for water recirculation and cooling. Some models include a pedal to control head movement.

Model	Power	Motor	Disc diameter mm	Length of cut
H0150	3 hp	220-50	300/350-25.4	600 mm
H0151	5.5 hp	220/380-50	400-25.4	600 mm
H0152	5.5 hp	220/380-50	500-25.4	600 mm
H0153	7.5 hp	220/380-50	600-25.4	550 mm

Model	Disc diameter
H0154	300 x 25.4 mm
H0155	350 x 25.4 mm
H0156	400 x 25.4 mm
H0157	500 x 25.4 mm
H0158	600 x 25.4 mm

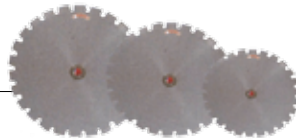

Standards EN 12390/3

H0161 Specimen grinder

Designed to polish and grind cylindrical and cubic specimens of concrete, stone, and natural rocks with a maximum height of 370 mm. This machine can simultaneously grind:

- 3 cubic specimens with 100 mm side length or
- 2 cubic specimens with 150 mm side length or
- 2 cubic specimens with 200 mm side length or
- 2 cylindrical specimens measuring \varnothing 100x200 mm, 110x220 mm, 150x300 mm, 160x320 mm

The specimens are fastened to the table using appropriate stirrups that guarantee perfect coupling and locking.

The rotating head has two speeds and moves in both directions powered by a separate motor. The column is completely protected against abrasive dust.

The accuracy of the vertical movement of the head is 0.05 mm. The base of the machine is made of sturdy sheet metal with a large lockable tool compartment.

Work table surface: 680 x 300 mm

Polishing head diameter: \varnothing 330 mm

Vertical spans: minimum 90 mm / maximum 370 mm

Power supply: 400 V 3ph 50 Hz 1500 W

Dimensions: 1300 x 1040 x 1500 mm

Weight: 430 Kg

The polishing machine is supplied with:

Water collection and decanting tank (50 L), electric pump, water-resistant protection screen, eight abrasion sections, set of locking stirrups for cubic specimens of side length 100 / 150 / 200 mm.



Accessories and spare parts:

H0161/1 Spare abrasion sections (8 units required).

H0161/2 Diamond polishing sections (8 units required), especially effective due to their long working life and good grinding action.

H0161/3 Set of fastening stirrups for cylinder specimens measuring \varnothing 100 / 110 / 150 and 160 mm

H0161/4 Set of fastening stirrups for simultaneous testing of 3 cubic specimens measuring 100 mm

Cylinder Capping Equipment

Standards UNE EN 12390-3, UNE 7240, 83303; ASTM C617; NF P18-416; BS 1881; AASHTO T23, T126

H0165 Electric vessel for melting sulphur

Rectangular shape with a capacity for 10 L. All stainless steel interior with double lining. Supplied with a thermostat for temperature control up to 300 °C.

Dimensions: 400 x 260 x 280 mm

Weight: 11 Kg



Accessories

H0165/1 Container with 10 litres of heating oil.

H0165/2 Stainless steel ladle to transfer sulphur.

H0165/3 Oil level dipstick.

H0166 Facing machine for cylinder specimens measuring \varnothing 150 mm

H0166/1 Plate for facing machine for cylinder specimens measuring \varnothing 150 mm

H0166E Special facing machine for specimens measuring standardised \varnothing 150 mm, with 60HRC plate hardness, as per Standard 83-303/84.

H0166/1E Plate for special facing machine for specimens measuring standardised \varnothing 150 mm with 60HRC hardness, as per Standard 83-303/84.

H0167 Facing machine for cylinder specimens measuring \varnothing 100 mm

H0168 Facing machine for cylinder specimens measuring \varnothing 75 mm

H0169 Micronised sulphur, 40 Kg package

H0171 Lampblack container, 11.5 Kg



Compression Testing Machines

A model for every need

Models designed to comply with the requirements of the most important international standards.

Wide range of models developing force ranging from 1500 to 6000 kN. A variety of measurement and control systems.

- *Manual models with analogue or digital display of force.*
- *Automatic models with manual loading speed control and digital display of force.*
- *Servo-controlled models with computer controlled digital display of speed and force.*

These models can be used for the following test specimen types:

- Concrete: cubic, cylinder, prism, bending tests, indirect tensile tests, etc.
- Flagstones.
- Ceramic test specimens.
- Rock and granite.

Wide range of test accessories.

Our machines are suitable for and cover the needs of our customers, from quality control laboratories to universities and research centres.

Our quality standards allow us to build sturdy, long-lasting, high-precision machinery capable of performing all types of tests.

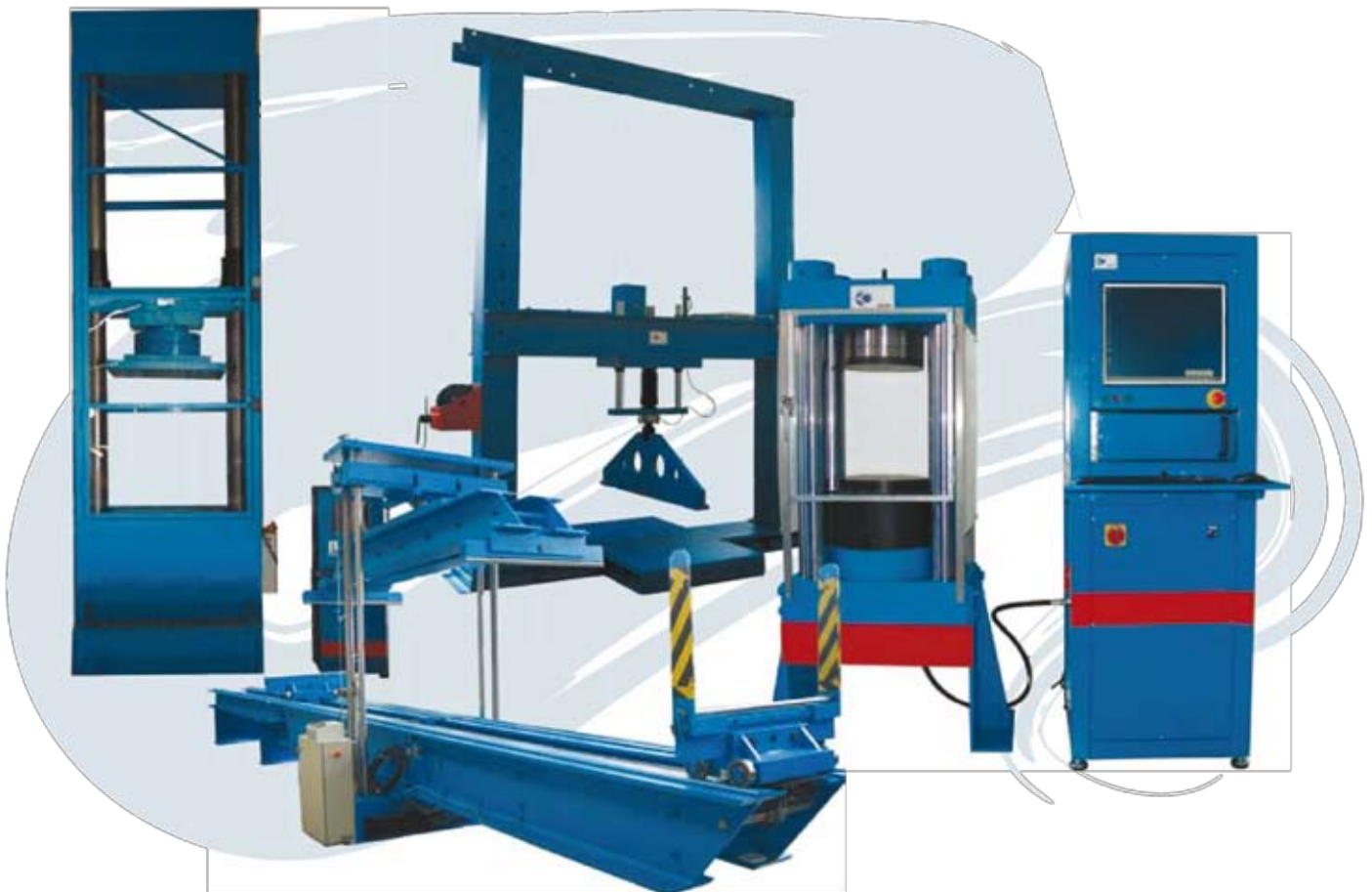

Compression Testing Machines

Standard UNE EN 12390-3, 12390-4; UNE 7281, UNE 83304; ASTM C39, E4, BS 1610; AASHTO T22, T71; DIN 51.220, 51.223; NF P18-411; BS 1610

This series of machines is designed to meet the needs of any compression test on concrete test specimens performed either in a laboratory or at a worksite. Class 1 construction with accuracy better than $\pm 1\%$ in compliance with international standards. This series features: sturdiness, measurement precision, easy handling, easy transportation and compliance with current standards. The rigid body structure in a weld-free frame ensures perfect repeatability and precision in test results. These machines can perform tests on the following types of test specimens, depending on their capacity and design:

Concrete test specimens:

- Cubic specimens.
- Cylindrical specimens.
- Prism specimens.
- Indirect tensile (Brazilian test).

Stone and concrete flagstones.

- Ceramic test specimens.
- Rock and granite.

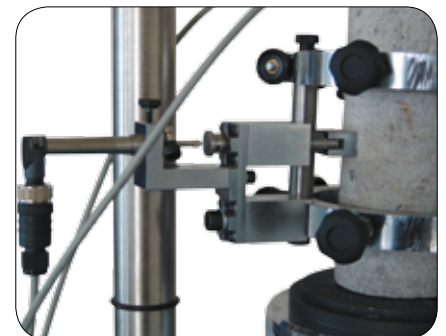
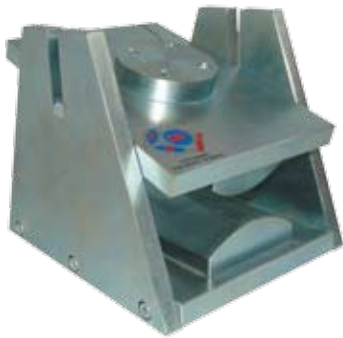



Testing area

This area consists of a compact, attractive, mechanically stable assembly of metal sections. The compression plates are tempered and ground, the bottom plate has concentric markings that are helpful for correct placement of test specimens. The upper plate includes a ball joint for perfect seating.

Hydraulic power pack

Powered by an electric motor with an oil tank and connections to the compression machines.



Pressure gauge

High precision, calibrated with maximum error under $\pm 1\%$.

Digital display with microprocessor

The display shows the load reading and the thrust unit value, works as a timer. Highly stable reading. When the test is finished, all the parameters can be seen on the screen and/or be sent to a printer.



Machines have display of force on a pressure gauge

Measurement and control systems

These machines are divided in groups according to capacity: 1200, 1500, 2000, 3000, 5000 and 6000 kN (other capacities on request). There are several options for load control and reading: pressure gauge, digital display, or PC

Compression test machines, capacity 1200 kN



H0200 Compact machine for 1200 kN hand powered, for compression tests in cylindrical, cubic, prism specimens and indirect tensile test. High precision pressure gauge reading, with reading error under $\pm 1\%$. Supplied with ENAC calibration certificate and instruction manual.

Compression test machines, capacity 1500 kN

H0210 Compact machine for 1500 kN hand powered, for compression tests in cylindrical, cubic, prism specimens and indirect tensile test.

High precision pressure gauge reading, with reading error under $\pm 1\%$. Supplied with ENAC calibration certificate and instruction manual .

H0212 Compact machine for 1500 kN motorised, for compression tests in cylindrical, cubic, prism specimens and indirect tensile test.

High precision pressure gauge reading, with reading error under $\pm 1\%$. Supplied with ENAC calibration certificate and instruction manual.



Compression test machines, capacity 2000 kN

H0220 Compact machine for 2000 kN hand powered, for compression tests in cylindrical, cubic, prism specimens and indirect tensile test. High precision pressure gauge reading, with reading error under $\pm 1\%$. Supplied with ENAC calibration certificate and instruction manual.

H0222 Compact machine for 2000 kN motorised, for compression tests in cylindrical, cubic, prism specimens and indirect tensile test. High precision pressure gauge reading, with reading error under $\pm 1\%$. Supplied with ENAC calibration certificate and instruction manual.

Compression test machines, capacity 3000 kN

H0230 Compact machine for 3000 kN hand powered, for compression tests in cylindrical, cubic, prism specimens and indirect tensile test. High precision pressure gauge reading, with reading error under $\pm 1\%$.

Supplied with ENAC calibration certificate and instruction manual.

H0232 Compact machine for 3000 kN motorised, for compression tests in cylindrical, cubic, prism specimens and indirect tensile test. High precision pressure gauge reading, with reading error under $\pm 1\%$. Supplied with ENAC calibration certificate and instruction manual.



Model	Capacity	Piston stroke	Free lateral spacing	Useful compression distance	Frame dimensions (mm)	Plate dimensions (mm)	Weight	Power supply
H0200	1200 kN	80 mm	230 mm	320 mm	460 x 600 x 810	190 x 190 x 50	280 Kg	Manual
H0210	1500 kN	80 mm	230 mm	320 mm	460 x 600 x 810	190 x 190 x 50	304 Kg	Manual
H0212	1500 kN	80 mm	230 mm	320 mm	460 x 600 x 810	190 x 190 x 50	344 Kg	220/380 V 50/60 Hz
H0220	2000 kN	80 mm	270 mm	320 mm	410 x 670 x 880	260 x 260 x 50	447 Kg	Manual
H0222	2000 kN	80 mm	270 mm	320 mm	410 x 670 x 880	260 x 260 x 50	487 Kg	220/380 V 50/60 Hz
H0230	3000 kN	80 mm	270 mm	320 mm	410 x 670 x 880	260 x 260 x 50	447 Kg	Manual
H0232	3000 kN	80 mm	270 mm	320 mm	410 x 670 x 880	260 x 260 x 50	487 Kg	220/380 V 50/60 Hz

Machines with digital display of force

Compression test machines, capacity 1500 kN

H0211 Compact machine for 1500 kN, hand powered, for compression tests in cylindrical, cubic, prism specimens and indirect tensile test. H0206/1 **digital display**. Supplied with ENAC calibration certificate and instruction manual.

Compression test machines, capacity 2000 kN

H0221 Compact machine for 2000 kN, hand powered, for compression tests in cylindrical, cubic, prism specimens and indirect tensile test. H0206/1 **digital display**. Supplied with ENAC calibration certificate and instruction manual.

Compression test machines, capacity 3000 kN

H0231 Compact machine for 3000 kN, hand powered, for compression tests in cylindrical, cubic, prism specimens and indirect tensile test. H02016/1 **digital display**. Supplied with ENAC calibration certificate and instruction manual.



Model	Capacity	Piston stroke	Free lateral distance	Useful compression space	Frame dimensions (mm)	Plate dimensions (mm)	Weight	Power supply
H0211	1500 kN	80 mm	230 mm	320 mm	450 x 600 x 810	190 x 190 x 50	304 Kg	Manual
H0221	2000 kN	80 mm	230 mm	320 mm	410 x 670 x 880	260 x 260 x 50	447 Kg	Manual
H0231	3000 kN	80 mm	230 mm	320 mm	410 x 670 x 880	260 x 260 x 50	447 Kg	Manual

Compression test machines, capacity 1500, 2000 and 3000 kN

H0213 Compact machine of 1500 kN capacity, motorised, for compression tests in cylindrical, cubic, prism specimens and indirect tensile test. H0206/1 digital display. Supplied with ENAC calibration certificate and instruction manual.

Technical characteristics

Capacity: 1500 kN.
Piston stroke: 80 mm
Free lateral distance: 270 mm
Distance between compression plates: 320 mm
Frame dimensions: 400 x 330 x 880 mm
Plate dimensions: 210 x 210 x 50 mm
Weight: 343 Kg approx
Power supply: 220/380 V. 50-60 Hz. Three phase.

H0223 Compact machine of 2000 kN capacity, motorised, for compression tests in cylindrical, cubic, prism specimens and indirect tensile test. H0206/1 digital display. Supplied with ENAC calibration certificate and instruction manual.

Technical characteristics

Capacity: 2000 kN.
Piston stroke: 80 mm
Free lateral distance: 270 mm
Distance between compression plates: 320 mm
Frame dimensions: 400 x 330 x 880 mm
Plate dimensions: 210 x 210 x 50 mm
Weight: 343 Kg approx
Power supply: 220/380 V. 50-60 Hz. Three phase.

H0233 Compact machine of 3000 kN capacity, motorised, for compression tests in cylindrical, cubic, prism specimens and indirect tensile test. H0206/1 digital display. Supplied with ENAC calibration certificate and instruction manual.

Technical characteristics

Capacity: 3000 kN.
Piston stroke: 80 mm
Free lateral distance: 270 mm
Distance between compression plates: 320 mm
Frame dimensions: 400 x 330 x 880 mm
Plate dimensions: 210 x 210 x 50 mm
Weight: 343 Kg approx
Power supply: 220/380 V. 50-60 Hz. Three phase.



Standard UNE EN 12390-3 for hardened concrete tests

Testing of specimen compression strength

These machines are designed to meet requirements for material compression tests, specifically on standard concrete test specimens: cubic, cylindrical and prism, as per standards EN 771/3, 12390-4, 12350; BS 1610, 1881; DIN 51220, 51302; NP 18411, 18412; ASTM C-39, E447; UNI 6686. Machine dimensions and design are suitable for performing other tests (bending, indirect tensile, etc) with the corresponding accessories. This equipment features high quality, sturdy construction, high precision, easy handling and compliance with current standards.

Testing area

This area consists of a compact, attractive, mechanically stable assembly of metal sections. The machine bed houses the unit, which consists of the sleeve with the piston on the lower bridge, including the pressure sensor; the upper crossbar closes off the test frame. Equipped with a user safety protection device, in compliance with standard CE 89/392.

The compression plates are tempered and ground in compliance with ISO 6507-1, the bottom plate has concentric markings that are helpful for correct placement of test specimens. The upper plate includes a ball joint for perfect seating.

Hydraulic motor pump group

The hydraulic pressure power pack is attached to the side of the machine and mounted on an anti-vibration system. The power pack is airtight and anti-pollutant with low noise level emission. It is equipped with a fine adjustment valve that acts on the oil flow through the circuit and facilitates selection of test speed. The unit is equipped with a device that shuts the system down automatically when specimen failure is detected.

Displays

H0206/1 digital display.

General Characteristics

14-bit Microprocessor board

Backlit alphanumeric display with 9 mm characters. Equipped with two data collection channels for connection to force, pressure or displacement transducers.

RS232C output for printer or PC.

Stores data in Excel format. (*.xls)

Measurement units available: N; daN; KN; Kgf; Nm; g; Kg; bar; mbar; Mpa; atm; V; mV; mV/V; mm; μ m.

Auto calibration key (zero)

Peak activation key.

Key for data transfer to PC or printer.

PROETI software for test data collection and transfer to a PC for printing or saving.

Power supply: 220 V. 50/60 Hz.

Dimensions: 200 x 80 x 130 mm

Weight: 1 Kg



H0206/PLUS Digital Force Display Module with UDI 16/4 PLUS Microprocessor

General characteristics

- 16-bit microprocessor board
- Back-lit LCD display with 240 x 128 pixel.
- Four programmable data collection channels for connection to force, pressure or displacement transducers.
- Two RS232C outputs for connection to a printer or PC.
- Stores data in Excel format. (*.xls)
- Measurement units available: N; daN; KN; Kg; Nm; g; Kg; bar; mbar; Mpa; atm; V; mV; mV/V; mm; μm .
- Menu available in 4 languages (Spanish, English, Portuguese and Italian).
- PROETI UDI16/4PLUS software for data/curve collection in real time.
- Choice of the specimen area to test.
- Choice of degree of load (N/s; Mpa/s; Kg/cm²s) and tolerance \pm % of value entered
- User selectable measurement channels.
- Automatic calculation of Maximum Force (Fm), Unit Load (Rm), average Degree Value.
- Recording of data in EXCEL format.
- Allows data saved in EXCEL format to be uploaded to a PC.

Power supply: 220 V 50/60 Hz.

Dimensions: 230 x 145 x 180 mm

Weight: 2 Kg

Software indicators

General Characteristics

- Allows the test to be followed from a PC and displays the test on the screen. The tests and curves can be saved in Excel format.
- Shows the characteristic load/time or load/deformation curve, depending on how the unit is set up and the configuration selected by the operator.
- Allows selection of a wide range of units of measurement for load gradient and test speed. (depending on the measurement transducer that is connected).
- Automatic mode peak function at the beginning of the test.
- View of the measurement channel/s chosen by the operator.
- Automatic calculation of Fm, Rm average gradient value and Lu values (when channel 2 is used for a displacement transducer).
- Stores data in Excel format. (*.xls)
- Easy to install PROETI computer software, allows test data to be collected and transferred to a PC (RS232C output), for printing or saving.
- View of data collection channel chosen by the operator.
- RS232C COM2 printing channel.
- RS232C COM1 PC connection channel.
- Operating temperature: + 10 °C to + 35 °C.



Machines with speed servo-control and digital force display

Standard UNE EN 12390-3 for hardened concrete tests Testing of specimen compression strength

This machine is designed to meet requirements for material compression tests, specifically on standard concrete test specimens: cubic, cylindrical and prism, as per standards EN 771/3, 12390-4, 12350; BS 1610, 1881; UNE 83304, 7242; DIN 51220, 51302; NP 18411, 18412; ASTM C-39, E447; UNI 6686. Machine dimensions and design are suitable for performing other tests (bending, indirect tensile, etc) with the corresponding accessories. This equipment features high quality sturdy construction, high precision, easy handling and compliance with current standards.

Testing area

This area consists of a compact, attractive, mechanically stable assembly of metal sections. The machine bed houses the unit, which consists of the sleeve with the piston on the lower bridge, including the pressure sensor; the upper crossbar closes off the test frame. Equipped with a user safety protection device, in compliance with standard CE 89/392.

The compression plates are tempered and ground in compliance with ISO 6507-1, the bottom plate has concentric markings that are helpful for correct placement of test specimens. The upper plate includes a ball joint for perfect seating.

Computerised servo-controlled group

A hydraulic unit that is servo-controlled by H0206 Plus module or by PC software. This unit was designed for complete control the machine and tests. The system is capable of performing compression and flexural strength tests adapted to any standard. The standard version consists of a unit connected to the loading piston. The machine is controlled by software that manages the tests, prepares graphs and presents the results.

The load control system is completely new and emulates a servo-valve using a pump that accurately controls oil flow to the piston, controlling the speed of rotation of the pump motor. This new system developed by Proetisa guarantees reliability and productivity, accurate results, repeatability and extreme precision.

Another very significant characteristic of this new system is its low noise level. The unit is extremely quiet.

The complete unit consists of:

PC with Windows XP and 19" TFT monitor or higher.

HP deskjet printer.

High pressure connection tube from the unit to the test frame/ piston.

Multilingual servo-control software to perform tests in compliance with EN 12390-3, EN 12390-5 and EN 196-1.

All test data and the failure curves are saved in *.mdb format to facilitate export to databases (Access, Excel) for custom management by the client.



H0260 Servo-controlled unit

H0261 Computer + Printer

H0209 Software

Servo-control software

The servo-control software has been designed for total control of the machine and the tests it performs. The system is capable of performing compression and flexural strength tests adapted to any standard. The press is controlled by the H0206 Plus module, equipped with four channels. These four channels can be dedicated and configured for all the possible options:

- Force – Force – Force – Force
- Force – Force – Deformation – Deformation
- Force – Force – Force – Deformation
- Force – Deformation – Deformation – Deformation
- Force – Deformation – Force – Deformation

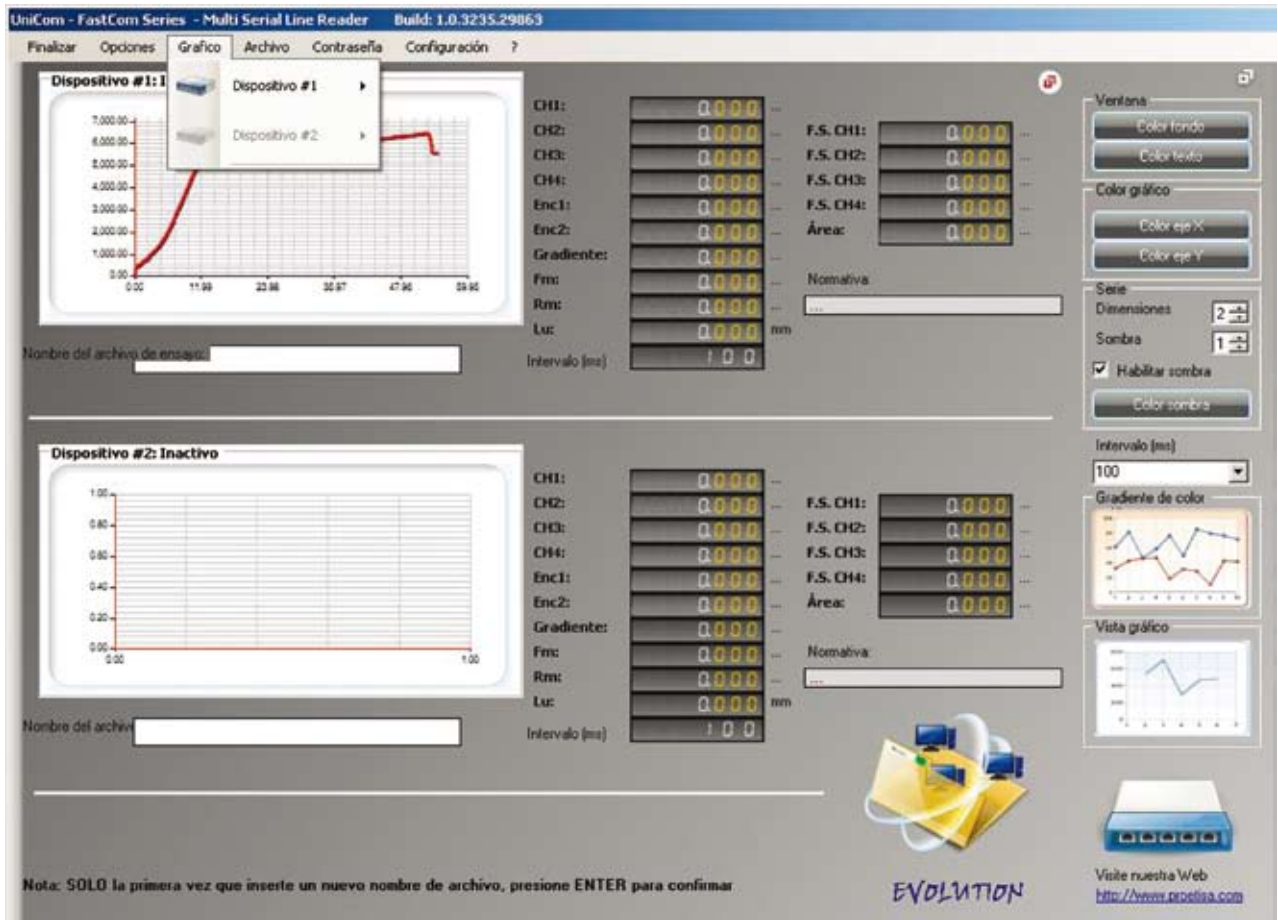

As many as four measuring bridges can be connected with a single module and the software. A combination press for concrete test specimen compression tests, plus a measuring bridge to test cement compressive strength failure, plus another measuring bridge to test cement flexural strength failure. The software manages all the tests, generates charts and presents the results. The load control system software is completely new and emulates a servo-valve using a pump that accurately controls oil flow to the piston, controlling the rotation speed of the pump motor. This new system developed by Proetisa guarantees high reliability and productivity, precise results, repeatability and extreme accuracy.



ETIMATIC

This unit is used for completely automatic test performance. All that is required is the push of a button and ETIMATIC does the rest.

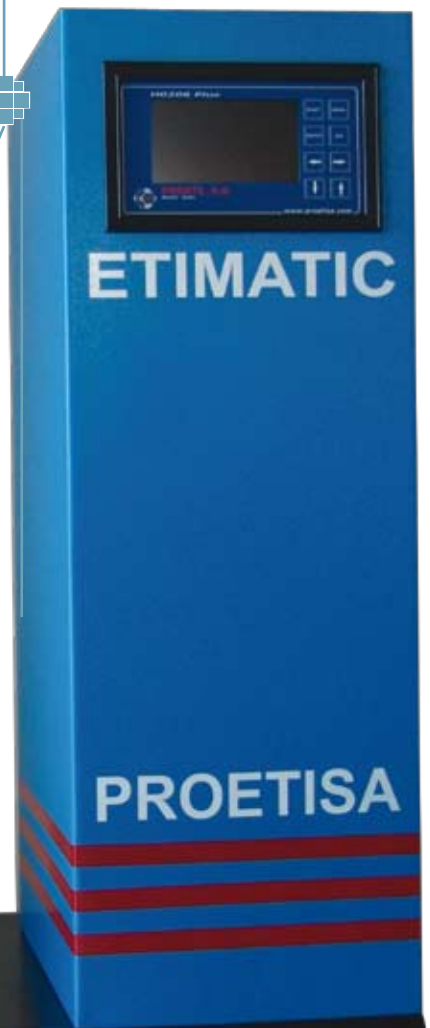



The **ETIMATIC** module includes a servo-assisted system that completely controls the load gradient. The operator simply has to choose the type of test specimen, its dimensions and start the test. The press and ETIMATIC will do the rest. The ETIMATIC unit can be installed in any measuring bridge in both concrete and cement machines. You can increase the productivity of your laboratory by purchasing this unit and modernising your old manual or motor powered press.

All cement, mortar and concrete tests are included in the internal firmware. Simply choose the Standard to apply.

- | | |
|---------------------------------------|---|
| Compression testing in concrete. | Compression testing in mortar / cement. |
| Flexural testing in concrete. | Flexural testing in mortar / cement. |
| Indirect tensile testing in concrete. | Flexural testing in mortar / cement. |

ETIMATIC will continuously display the load, the failure load and the strength calculation in the selected units in real time. ETIMATIC can be used with more than one measuring bridge.

For example, a rack for bending tests and another rack for compression tests can be connected.

The unit will control and perform the tests according to the Standard chosen.

The load control system is completely new and emulates a servo-valve using a pump that accurately controls oil flow to the piston, controlling the rotation speed of the pump motor.

This new system developed by Proetisa guarantees reliability and productivity, accurate results, repeatability and extreme precision.

Another very significant characteristic of this new system is its low noise level. The unit is extremely quiet.



H0206/PLUS Universal digital display

The press is controlled by the H0206 Plus module, equipped with four channels.

These four channels can be dedicated and configured for all the possible options:

- FORCE – FORCE – FORCE – FORCE
- FORCE – DEFORMATION – FORCE – DEFORMATION
- FORCE – FORCE – FORCE – DEFORMATION
- FORCE – DEFORMATION – DEFORMATION – DEFORMATION
- FORCE – DEFORMATION – FORCE – DEFORMATION

As many as four measuring bridges can be controlled with a single module and the software.

A combination press for concrete test specimen compression tests, plus a measuring bridge for cement compressive failure, plus another measuring bridge for cement / concrete flexural failure.

Machines with speed servo-control and digital force display - ETIMATIC Series

Compression testing machines, capacity 1500, 2000, 3000 and 5000 kN

H0214 Servocontrolled Compac Compression Testing Machine, 1500 KN capaci-

For compression tests in cylindrical, cubic, prism and indirect tensile test specimens. H0206 PLUS digital display reading with microprocessor. Supplied with ENAC calibration certificate and instruction manual.

The ETIMATIC module includes a servo-assisted system that completely controls the load gradient. The operator simply has to choose the type of test specimen, its dimensions and start the test. The press and ETIMATIC will do the rest. The display will continuously show the load, the failure load and the strength calculation in the selected units in real time.

The load control system is completely new and emulates a servo-valve using a pump that accurately controls oil flow to the piston, controlling the rotation speed of the pump motor. This new system developed by Proetisa guarantees reliability and productivity, accurate results, repeatability and extreme precision. Another very significant characteristic of this new system is its low noise level. The unit is extremely quiet. Press performance can be expanded by adding a rack for bending tests.

Technical characteristics

External unit dimensions: 720 X 420 X 1600 mm

Frame dimensions: 390 x 300 x 870 mm

Plate dimensions: 190 x 190 x 50 mm

Capacity: 1500 kN.

Piston stroke: 80 mm

Free lateral distance: 230 mm

Distance between compression plates: 320 mm

Weight: 344 Kg approx.

Power supply: 220/380 V 50-60 Hz. Three phase.



H0224 Servocontrolled Compac Compression Testing Machine, 2000 KN capaci-

For compression tests in cylindrical, cubic, prism and indirect tensile test specimens. H0206 PLUS digital display reading with microprocessor. Supplied with ENAC calibration certificate and instruction manual.

The ETIMATIC module includes a servo-assisted system that completely controls the load gradient. The operator simply has to choose the type of test specimen, its dimensions and start the test. The press and ETIMATIC will do the rest. The display will continuously show the load, the failure load and the strength calculation in the selected units in real time.

The load control system is completely new and emulates a servo-valve using a pump that accurately controls oil flow to the piston, controlling the rotation speed of the pump motor. This new system developed by Proetisa guarantees reliability and productivity, accurate results, repeatability and extreme precision. Another very significant characteristic of this new system is its low noise level. The unit is extremely quiet. Press performance can be expanded by adding a rack for bending tests.

Technical characteristics:

Capacity: 2000 kN

Piston stroke: 80 mm

Free lateral distance: 270 mm

Distance between compression plates: 320 mm

Frame dimensions: 390 x 300 x 870 mm

External unit dimensions: 720 X 420 X1 600 mm

Plate dimensions: 260 x 260 x 50 mm

Weight: 487 Kg approx.

Power supply: 220/380 V. 50-60 Hz. Three phase.

H0234 Servocontrolled Compac Compression Testing Machine, 3000 KN capaci-

For compression tests in cylindrical, cubic, prism and indirect tensile test specimens. H0206 PLUS digital display reading with microprocessor. Supplied with ENAC calibration certificate and instruction manual.

The ETIMATIC module includes a servo-assisted system that completely controls the load gradient. The operator simply has to choose the type of test specimen, its dimensions and start the test. The press and ETIMATIC will do the rest. The display will continuously show the load, the failure load and the strength calculation in the selected units in real time.

The load control system is completely new and emulates a servo-valve using a pump that accurately controls oil flow to the piston, controlling the rotation speed of the pump motor. This new system developed by Proetisa guarantees reliability and productivity, accurate results, repeatability and extreme precision. Another very significant characteristic of this new system is its low noise level. The unit is extremely quiet. Press performance can be expanded by adding a rack for bending tests.



H0254 Servocontrolled Compac Compression Testing Machine, 5000 KN capaci-

For compression tests in cylindrical, cubic, prism and indirect tensile test specimens. H0206 PLUS digital display reading with microprocessor. Supplied with ENAC calibration certificate and instruction manual.

The ETIMATIC module includes a servo-assisted system that completely controls the load gradient. The operator simply has to choose the type of test specimen, its dimensions and start the test. The press and ETIMATIC will do the rest. The display will continuously show the load, the failure load and the strength calculation in the selected units in real time.

The load control system is completely new and emulates a servo-valve using a pump that accurately controls oil flow to the piston, controlling the rotation speed of the pump motor. This new system developed by Proetisa guarantees reliability and productivity, accurate results, repeatability and extreme precision. Another very significant characteristic of this new system is its low noise level. The unit is extremely quiet.

Press performance can be expanded by adding a rack for bending tests.

Technical characteristics

Capacity: 5000 kN.

Piston stroke: 80 mm

Free lateral distance: 280 mm

Distance between compression plates: 320 mm

Frame dimensions: 390 x 300 x 870 mm

External unit dimensions: 720 X 420 X1 600 mm

Plate dimensions: 260 x 260 x 50 mm

Weight: 580 Kg approx.

Power supply: 220/380 V. 50-60 Hz. Three phase.



Accessories for testing machines

Accessories

H0270 A bending test frame with 150 kN capacity, designed to work jointly with compression test machines. This machine can perform bending tests on prism test specimens measuring 150 x 150 x 600 or 750 mm and 100 x 100 x 400 or 500. The upper and lower rollers can be easily adjusted to the dimensions of the test specimen. A single hydraulic unit with a hydraulic distribution valve acts on the compression or bending test frame.



Technical characteristics

Load capacity: 150 kN.

Maximum vertical span: 160 mm

Upper roller length: between 100 and 455 mm

Roller diameter: 160 mm

Maximum distance between upper rollers: 40 to 155 mm

Piston stroke: 50 mm

Power supply: 220/ 380 V. 50/60 Hz.

Dimensions: 540 x 460 x 1120 mm

H0205/4 High strength pedestal made of painted sheet metal, reinforced on the inside by electrically welded corners. To support presses of 1500/3000 kN capacity, external dimensions of 600 x 700 x 450 mm

S0360 150 mm deformation or displacement meter



Automatic computer-controlled machines

Automatic Compression Testing Machines 2000 to 6000 kN capacity, computer-controlled with ETIWIN system.

This type of machine has been specifically designed and built to meet the requirements of users that need to test material strengths at the worksite or in a laboratory. Class 1 construction with accuracy better than $\pm 1\%$ in compliance with international standards: UNE EN 12.390; AASHTO T22; ASTM E4

This series features: sturdiness, measurement precision, easy handling, easy transportation and compliance with current standards. The rigid body structure in a weld-free frame ensures perfect repeatability and precision in test results.

The machine consists of two parts:

- The test frame.
- The control desk.

Test Frame

The frame consists of an attractive, mechanically stable, compact, undeformable system of 4 columns. The bottom machine bed houses the sleeve and piston unit; the upper crossbar closes off the test frame.

The compression plates are tempered and ground in compliance with the requirements for hardness, flatness and smoothness described in standard UNE EN 12.390. The bottom plate has concentric markings that are very helpful for correct placement of the test specimens. The top plate includes a self-locking ball joint for perfect seating of the specimen.

Machine capacity and design allow it to be used to perform tests on the following types of test specimens:

Concrete test specimens

- Cubic specimens measuring 10, 15 and 20 cm
- Cylinder specimens measuring $\varnothing 15 \times 30$ y 16×32 cm
- Prism specimens measuring up to $350 \times 500 \times 250$ mm
- Indirect tensile test (Brazilian test)*.
- Prism test specimen bending test*.
- (With use of the corresponding accessory)*

Stone and concrete flagstones.

- Ceramic test specimens.
- Rock and granite.
- Prefabricated blocks.



The top plate includes a round self-locking ball joint with its centre of rotation on the base of the plate to prevent lateral stresses and the resulting application of axial forces on the test specimen.

The test frame includes a locking transparent FRONT DOOR for protection of the user against pieces of the specimen being ejected during the test. This complies with E.C. directives.

Control desk

Made of oven-painted steel sheet metal, consisting of the following basic components:

Hydraulic unit.

Computer system for test measurement, control and recording.

The test frame includes an emergency stop device and low voltage conditioners.



Desk dimensions: 1430 x 600 x 930 mm

Weight: 200 Kg approx.

The hydraulic unit is mounted on an anti-vibration system and housed in the lower part of the control desk. This high pressure hydraulic unit is airtight, anti-pollutant and with very low noise emission. It is powered by an electric motor and equipped with an on-off switch. The servo-control performs an automatic closed loop control of loads from 2000 Kg, to ensure that load application is constant and uniform.

The hydraulic cylinder and piston are made of special ground steel. An end-stop device restrains the piston. Given the high pressures that occur during compression tests, an O-ring has been placed in one of the grooves of the cylinder to reduce friction to a minimum.

The unit is equipped with a series of safety accessories:

Anti-overpressure valve.

Magnetic anti oil pollution filter.

Protection device against power anomalies.



System for test measurement, control and recording.

The system for data control, acquisition and collection is completely automatic and carried out by the following equipment and components.

Compatible PC.

National Instruments 16 channel card.

ETIWIN software.

The machine is controlled by software. The software was developed by our own IT department. Programming, in a Labview environment, enables the machine to be controlled via the National Instruments card (installed in the PC). The card, the software and the servo-control allow precise control of the test with capacity for collecting up to 100,000 data items per second. As a result, the applied force is controlled very effectively and real test result charts can be obtained.

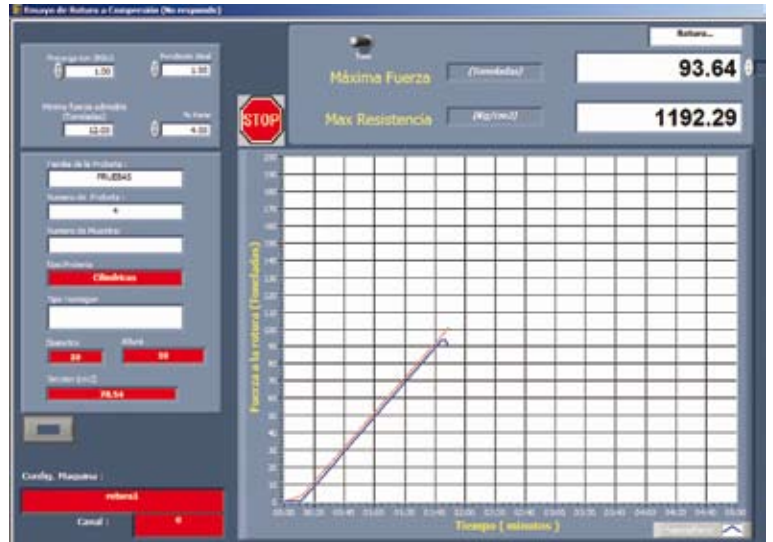

Tamaño	Nº Prueba	Edad Prueba	Tipo Prueba	Control de Humedad	Rotura	Rotura (Toneladas)
PRUBA1	1	47.000	Comprim	NORMAL	Romper Prueba	0.40
PRUBA2	2	47.000	Comprim	NORMAL	Romper Prueba	0.40
PRUBA3	3	47.000	Comprim	NORMAL	Romper Prueba	0.40
PRUBA4	4	47.000	Comprim	NORMAL	Romper Prueba	0.40
PRUBA5	5	47.000	Comprim	NORMAL	Romper Prueba	0.40
PRUBA6	6	47.000	Comprim	NORMAL	Romper Prueba	0.40
PRUBA7	7	47.000	Comprim	NORMAL	Romper Prueba	0.40
PRUBA8	8	47.000	Comprim	NORMAL	Romper Prueba	0.40
PRUBA9	9	47.000	Comprim	NORMAL	Romper Prueba	0.40
PRUBA10	10	47.000	Comprim	NORMAL	Romper Prueba	0.40
PRUBA11	11	47.000	Comprim	NORMAL	Romper Prueba	0.40
PRUBA12	12	47.000	Comprim	NORMAL	Romper Prueba	0.40
PRUBA13	13	47.000	Comprim	NORMAL	Romper Prueba	0.40
PRUBA14	14	47.000	Comprim	NORMAL	Romper Prueba	0.40
PRUBA15	15	47.000	Comprim	NORMAL	Romper Prueba	0.40
PRUBA16	16	47.000	Comprim	NORMAL	Romper Prueba	0.40
PRUBA17	17	47.000	Comprim	NORMAL	Romper Prueba	0.40



In addition, the 16 channel card can be used to add new transducers to the machine to perform new tests such as elastic modulus calculation, Poisson coefficient, etc.

The control of the machine makes it easier to perform dynamic tests. For example, the application of a load during a period of time without breaking the specimen, reducing the load and holding it steady for a period, applying a second load (equal to or greater than the first load) and so on while programming as many loading and unloading cycles as desired.

One of the advantages of this equipment is that it is completely automatic. A single push of a button instigates the following steps:

- The test is performed.
- The failure is detected.
- The results are saved.
- The equipment returns to its original position at maximum speed.
- The graph is displayed.
- The test is printed, etc.

The machine according to the description, consists of the following components:

- Test frame
- Compression plates
- Control desk
- Computer
- Printer
- ETIWIN programme

Quality

Our company has been awarded the UNE-EN-ISO 9001:2000 Quality Certificate. Our system and process controls guarantee the quality of the equipment we manufacture. The press is subject to strict controls during the manufacturing process, to guarantee the quality of the final product. The product is delivered with the following certificates:

- ENAC calibration certificate for force measuring instruments ISO 7500-1
- Plate hardness certificate. (in compliance with UNE EN 12.390).
- Plate flatness certificate. (in compliance with UNE EN 12.390).
- Plate smoothness certificate. (in compliance with UNE EN 12.390).

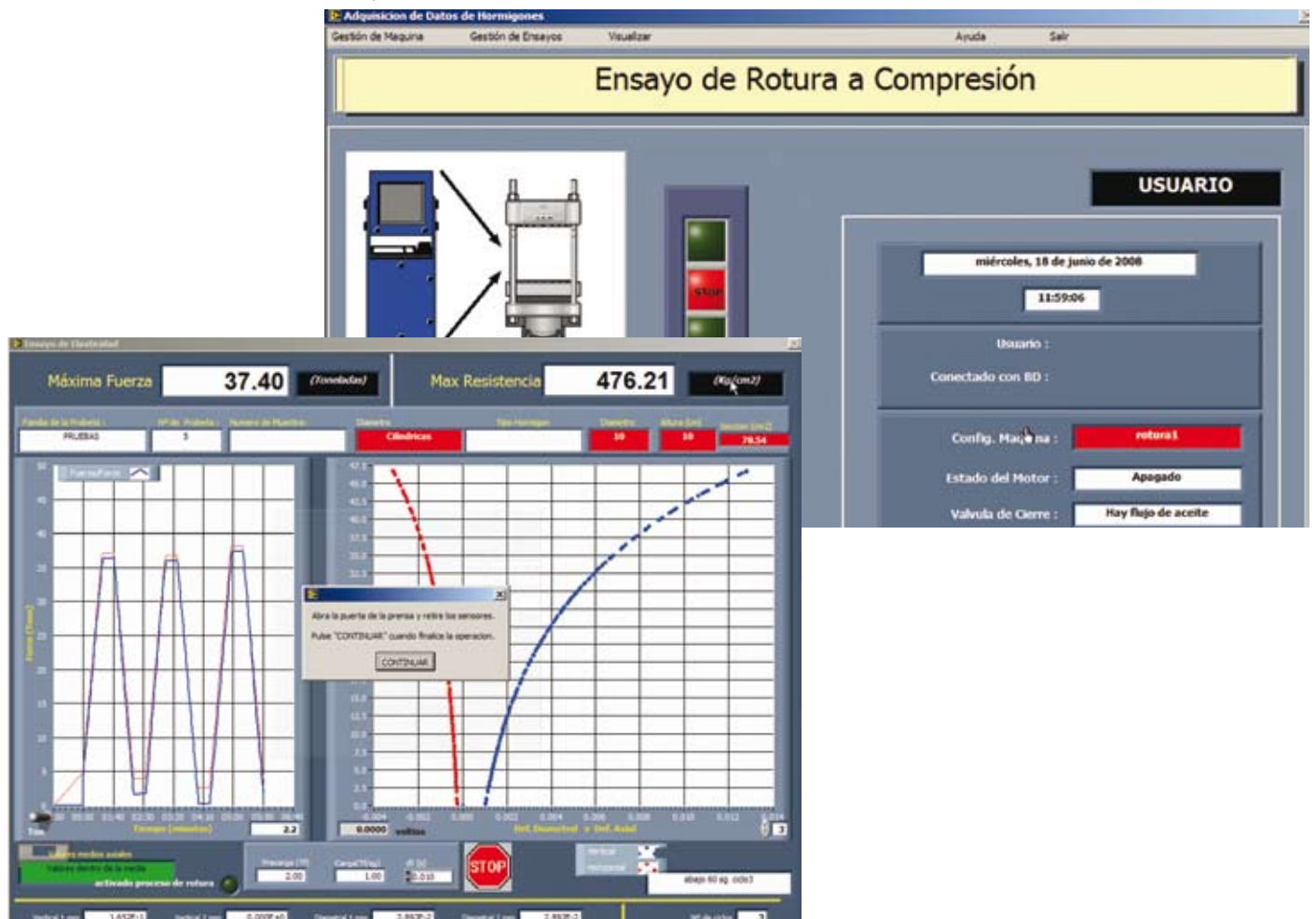

H0225 Automatic Compression Testing Machine, 2000 KN capacity

For material testing, computer-controlled by ETIWIN.

Description:

Computer-controlled compression testing machine with 2000 kN capacity. This machine can be used for compression tests in cylindrical, cubic, prism and indirect tensile test specimens. Computer control is provided in a separate module. The machine is supplied with ETI-WIN software, ENAC calibration certificate and instructions.

Technical characteristics:

Maximum force: 2000 kN.

Cylinder stroke: 150 mm

Cylindrical compression plates:

Bottom plate: \varnothing 350 mm

Top plate: \varnothing 285 mm

Supplementary plate: 50 mm x 300 mm

Test frame dimensions:

1730 x 950 x 490 mm

Distance between compression plates:

410 mm

Free lateral distance: 360 mm

Approximate frame weight: 1,500 Kg



H0235 Automatic Compression Testing Machine, 3000 KN capacity

For material testing, computer-controlled by ETIWIN.

Description:

Computer-controlled compression testing machine with 3000 kN capacity. This machine can be used for compression tests in cylindrical, cubic, prism and indirect tensile test specimens. Computer control is installed in a separate module. The machine is supplied with ETI-WIN software, ENAC calibration certificate and instructions.

Technical characteristics:

Maximum force: 3000 kN

Cylinder stroke: 150 mm

Cylindrical compression plates:

Bottom plate: \varnothing 350 mm

Top plate: \varnothing 285 mm

Supplementary plate: 50 mm x 300 mm

Test frame dimensions: 1730 x 950 x 490 mm

Distance between compression plates: 410 mm

Free lateral distance: 360 mm

Approximate frame weight: 1,500 Kg

H0255 Automatic Compression Testing Machine, 5000 kN capacity

For material testing, computer-controlled by ETIWIN.

Description:

Computer-controlled compression testing machine with 5000 kN capacity. This machine can be used for compression tests in cylindrical, cubic, prism and indirect tensile test specimens. Computer control is installed in a separate module. The machine is supplied with ETI-WIN software, ENAC calibration certificate and instructions.

Technical characteristics:

Maximum force: 5000 kN.

Cylinder stroke: 150 mm

Cylindrical compression plates:

Bottom plate: \varnothing 350 mm

Top plate: \varnothing 285 mm

Spare plate: 50 mm x 300 mm

Test frame dimensions: 1850 x 1050 x 540 mm

Distance between compression plates: 410 mm

Free lateral distance: 360 mm

Approximate frame weight: 1,860 Kg



H0265 Automatic Compression Testing Machine, 6000 kN capacity

For material testing, computer-controlled by ETIWIN.

Description:

Computer-controlled compression testing machine of 6000 kN capacity. This machine can be used for compression tests in cylindrical, cubic, prism and indirect tensile test specimens. Computer control is installed in a separate module. The machine is supplied with ETI-WIN software, ENAC calibration certificate and instructions.

Technical characteristics:

Maximum force: 6000 kN.

Cylinder stroke: 150 mm

Cylindrical compression plates:

Bottom plate: \varnothing 350 mm

Top plate: \varnothing 285 mm

Supplementary plate: 50 mm x 300 mm

Test frame dimensions: 1850 x 1050 x 540 mm

Distance between compression plates: 410 mm

Free lateral distance: 360 mm

Approximate frame weight: 1,860 Kg

Accessories

H0253 Compressometer, to determine the elastic modulus (Young). This instrument is used to measure vertical deformation in cylinder test specimens measuring \varnothing 150 x 300 mm during the compression test. It requires two LDVT displacement sensors (S0237/0) and two signal converters (S0238/0) neither of which are included.

H0253/1 Diameter deformation measuring device, to determine the elastic modulus (Young, Poisson and rigidity or shear modulus) if used together with the H0253. This machine is used to measure horizontal and vertical deformation (H0253) in cylinder test specimens measuring \varnothing 150 x 300 mm. It requires two LDVT displacement sensors (S0237/0) and two signal converters (S0238/0), neither of which are included.

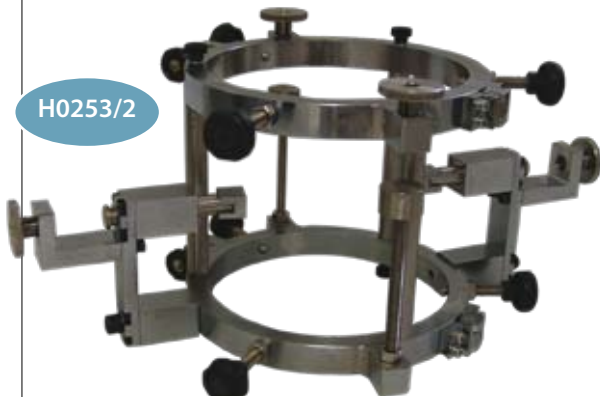

H0253/2 Compressometer-extensometer, to determine the elastic modulus (Young, Poisson and rigidity or shear modulus). This instrument is used to measure horizontal and vertical deformation in cylinder test specimens measuring \varnothing 150 x 300 mm and 160 x 320 mm during the compression test. It requires four LDVT displacement sensors (S0237/0) (two for vertical deformation and two for diameter deformation), not included and four signal converters (S0238/0). (V0024 digital comparators or V0015 analogue comparators can be used.)



Accessories II

H0253/3 Compressometer, to determine the elastic modulus (Young). This instrument is used to measure thrust and deformation in cubic test specimens measuring 150 mm per side during the compression test. It requires two LDVT displacement sensors (S0237/0), not included, and two signal converters (S0238/). (V0024 digital comparators or V0015 analogue comparators can be used.)



H0237/0

V0015



H0253/3



V0024



H0256 Bending device, adapted for prism test specimens measuring 150 x 150 x 600 mm. Supplied with steel rollers



EN 12390-6; ASTM C446; NF P18-408

H0257 Indirect tensile test device (Brazilian test), adapted for test specimens measuring \varnothing 150 x 300 and 160 x 320 mm. The device consists of a bottom supporting plate with a self-centring system and a top supporting element for the compression plate

H0273 Indirect tensile test device

Adapted for cubic test specimens measuring 100 and 150 mm

Dimensions: 350 x 250 x 264 mm

Accessories III

H0272 Device for kerb bending tests



S0237

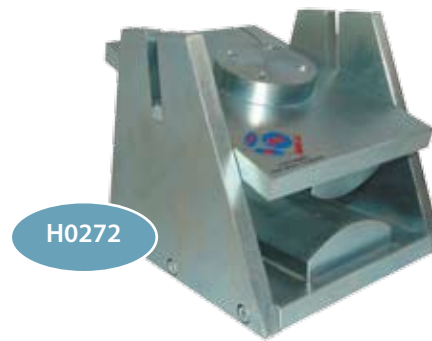

H0272

H0290 Brick facing machine



H0290

H0258 Bending test machine for ceramics, terrazzo, roof tiles, baked clay and brick, in compliance with standards UNE 127.006, 67-035, 67-03767-042,67100

S0237 LDVT displacement sensors (2 mm)

H0238/0 Signal converters



H0238/0



H0250
H0251



H0252

H0250 Reducing plate measuring 180 x 50 mm, made of steel.
Thickness: 50 mm

H0251 Reducing plate
measuring 180 x 75 mm, made of steel.
Thickness: 75 mm

H0252 Safety protection.

ETI-WIN software

Standards UNE EN 12390, EN 10002.2; ASTM C42; BS 1610

Software for concrete

The machine is delivered with the H0240 FAILURE PROGRAM. This software can be used to carry out all types of tests and efficient machine control. A series of software packages are available for automatic carrying out and calculations in respect of the following tests:

- Calculation of elastic modulus (Young, Poisson and shear).**
- Flexural strength test.**
- Indirect tensile failure test, Brazilian method.**

Our test specimen management system is also available for purchase. A database for joint processing of test specimens using the failure software.

H0240/1 Elasticity programme

Calculation of elastic modulus (Young, Poisson, shear).

H0240/2 Flexural strength program

H0240/3 Indirect tensile strength program (Brazilian)

H0240/4 Database program (management)



Determining the elastic modulus and strength characteristics of concrete specimens and test specimens in single axis conditions

Determining the elastic modulus, Poisson coefficient and shear modulus.

Standards ASTM D3148, D2938, D5407, D2664

The single axis test is carried out by applying an increasing load at a constant stress rate of between 0.5 and 1.0 MPa/s. Axis and diameter deformation must be measured with great precision (approx. 5×10^{-6}). Afterwards, loading and unloading cycles are applied to determine compressibility properties. These tests require the use of a servo-controlled force application system. The system should be servo-controlled and not simulated, since the tests require application of very precise loads during very precise time periods.

The machine is controlled by the software installed. The software was developed by our own IT department. Programming, in a Lab-view environment, enables the machine to be controlled via the National Instruments card (installed in the PC). The card, the software and the servo-control provide precise test control, to ensure gradients are controlled during both loading and unloading processes. The system captures up to 100,000 data items per second. As a result, the applied force is controlled very effectively and real test result graphs can be obtained. In addition, the 16 channel card can be used to add new transducers to the machine to carry out new tests such as elastic modulus calculation, Poisson coefficient, etc.

The control of the machine makes it easier to perform dynamic tests. For example, the application of a load during a period of time without breaking the specimen, reducing the load and holding it steady for a period, applying a second load (equal to or greater than the first load) and so on while programming as many loading and unloading cycles as desired.



Single axis tests with extensometric bands

The purpose of the test is to establish a method to determine stress-deformation curves, elastic modulus (Young) and Poisson coefficient in single axis compression of a regular cylindrical specimen.

The extensometric bands must be previously installed on the specimen to be tested. The orientation and position of the bands is very important because they will condition the results of the test. The extensometric bands must be chosen according to the grain size of the rock to be tested. Four bands should be placed on each specimen, two for axial deformation and two for diametral deformation.

To obtain optimal results, each band should be installed in a complete Wheatstone bridge. Data is collected by a computer, although it is first passed through a signal conditioner.

The software performs the entire process automatically, starting the test, controlling the cycles, collecting data, etc. The data can be viewed in real time while the test is being performed.



Equipment required

The system is exportable, i.e., these tests can be performed with other concrete presses other than those manufactured by our company.

Computer-controlled 2000 kN to 3000 kN press. The press has to be servo-controlled. Ideally, it should allow gradient control during loading and unloading (see concrete section). In many cases, electro-mechanical multi-purpose testing machines can be used for these tests, depending on the specimen section to be tested (concrete specimens)

Extensometric bands.

Signal conditioner with capacity for 16 bands

Compatible PC

Data collection card

Elasticity software.

H0235 3000 kN press

S0373 Multipurpose 300 kN testing machine

H0561 Extensometric bands with 10 mm base length

H0562 Extensometric bands with 20 mm base length

H0563 Extensometric bands with 30 mm base length

H0564 Extensometric bands with 60 mm base length

H0560 Signal conditioner with capacity for 16 bands

H0235PC Compatible PC

H0240/1 Elasticity software



Single axis tests with LVDT sensors

The purpose of the test is to establish a method to determine stress-deformation curves, elastic modulus (Young) and Poisson coefficient in single axis compression of a regular cylindrical specimen.

LVDT sensors are the best option when the nature of the rock does not allow for placement of extensometric bands. This occurs with highly porous specimens.

A compression gauge is required to position the LVDTs. Two LVDTs are positioned to measure diametral deformation and another two are placed to measure axial deformation. Data is collected by computer, although the data from the LVDT first passes through a data collection box that carries out the conversion.



The software performs the entire process automatically, starting the test, controlling the cycles, collecting data, etc. The data can be viewed in real time while the test is being performed.

Equipment required

The system is exportable, i.e., these tests can be performed with other concrete presses other than those manufactured by our company.

2000 kN to 3000 kN press with computer control. The press has to be servo-controlled. Ideally, it should allow gradient control during loading and unloading. In many cases, electro-mechanical multipurpose testing machines can be used for these tests, depending on the specimen section to be tested. (concrete specimens)

LVDT sensors

Data collection box with 16 channels

Compatible PC

Data collection card

Elasticity software.

H0235 3000 kN press

S0373 Multipurpose 300 kN testing machine

S0237 LVDT 2 mm sensor

S0200 Data collection box

H0254 Compressometer versus extensometer

H0235 Compatible PC

H0240/1 Elasticity software



Adquisición de Datos de Hormigones

Gestión de Máquina Gestión de Ensayos Visualizar Ayuda Salir

Elasticidad en HORMIGONES

UNE 22-950-90 y UNE 83316:1996

USUARIO

miércoles, 18 de junio de 2008

12:06:31

Usuario : _____

Conectado con ID : _____

Estado del Motor : Apagado

Valvula de Cierre : Hay flujo de aceite

Tiene Usted que calibrar (Por primera vez) o volver a calibrar (ha pasado 1 año de la instalación) Sensores a calibrar:
DFL1
DFL2

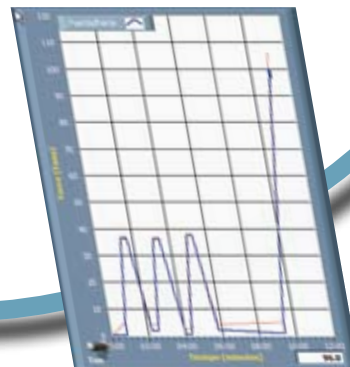
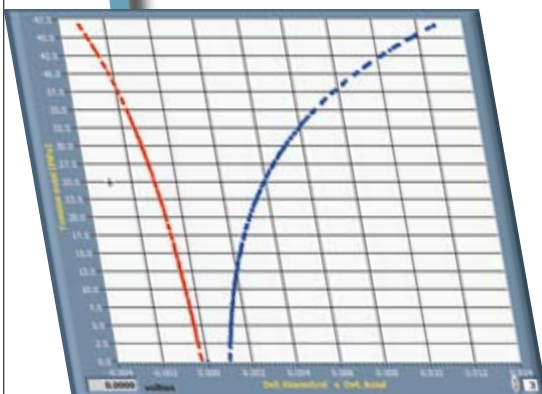
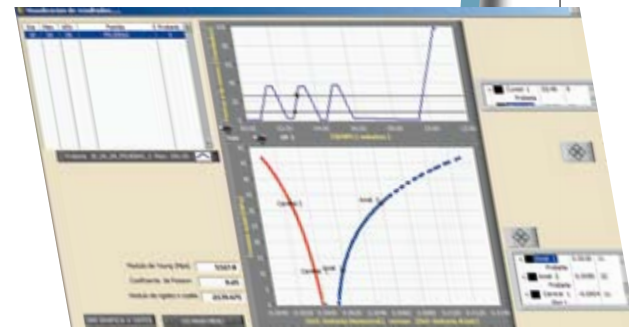
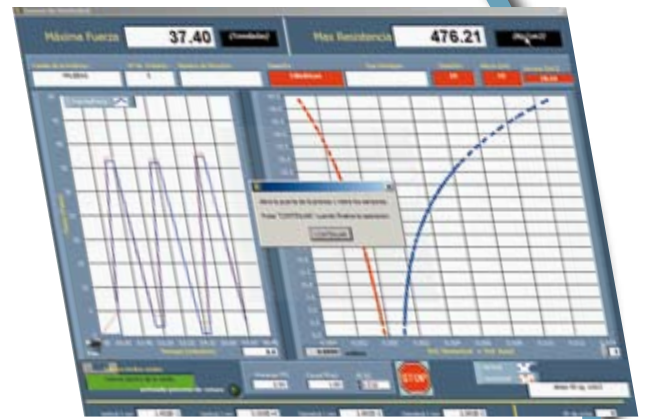
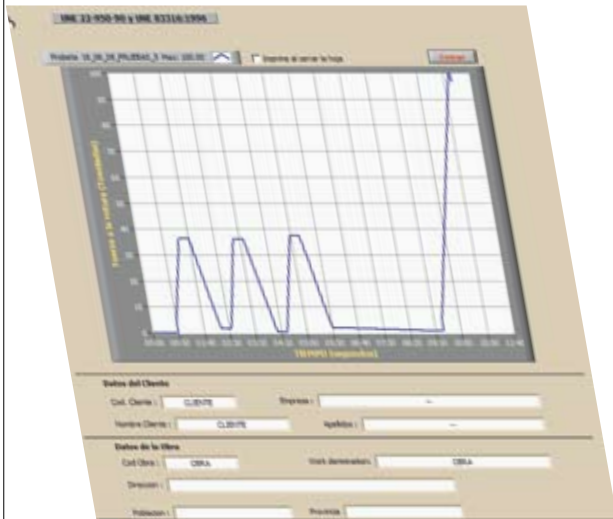

Machine for flexural testing of roof tiles, floor tiles and plaster boards

H0235 Electromechanical machine, suitable for flexural strength tests in roof tiles, floor tiles, plaster boards in tests that call for light loads applied gradually. Capacity: 30kN.

The rack is very stable and consists of two sturdy chrome steel columns joined by the machine bed at the bottom and an adjustable cross-head at the top.

The bottom area houses the direct current 0.33 V motor that drives the thrust spindle with a maximum stroke of 12 cm

The system includes protection measures against overloads, as well as an end-stop.

In the test area there are 2 lower supports on the spindle, one of which swivels, as does the top or loading roller to guarantee ideal load application.

The front part has a main on/off switch, a keypad for raising or lowering, test speed preselection and indicator lights.

Technical characteristics:

• Capacidad	30 kN x 125 mm
• Drive	Electromechanical by DC servo-motor and a ball screw shaft
• Controlled speeds	0 - 100 mm/min approach speed.
• Controlled speeds	100 mm/min return speed.
• Test speeds	0 - 300 N/s (0 to 100% speed).
• Control	CR-S Electronic with manual speed selection
• Approach system	Forward speed adjustment only.
• Spindle stroke	> 125 mm
• Force transducer	AEP TC-4 model for Tension/Compression.
• Overload capacity	150%.
• Linearity	0.10 %.
• Force precision	PROETI, S.A. guarantees better than 0.5% precision.
• Power supply	220 V. single phase + ground.
• Tools for flexural strength test in floor tiles:	Support rollers on mobile bottom platform. Two bottom supports measuring $\varnothing 40 \times 610$ mm, the lowest of which is a swinging support. Adjustable distance of up to >650 mm Dancing top roller $\varnothing 40 \times 610$ mm
• Dimensions:	1040 x 1220 x 850 mm (height x width x depth)
• Weight:	180 Kg

Supplied as per description with ENAC calibration certificate and instruction manual.



Standards EN 12390-5, EN 1340, UNE 83305; ASTM C78; AASHTO T97; BS 1881; NF P18-407; DIN 5 1227

Flexure strength test frame with capacity for 1500 kN

Sturdy frame designed for flexural strength tests on prism specimens measuring 10 x 10 x 40 or 50 cm and 15 x 15 x 60 or 75 cm, kerbs and beams. It can be used alone or in combination with any of the compression machine models described in this section.

The distance between the top and bottom rollers can be adjusted conveniently to the dimensions of the test specimen. The top rollers are hinged so they can be applied appropriately to the load.

Technical characteristics:

Roller length: 165 mm

Roller diameter: 16 mm

Piston stroke: 100 mm approx.

Dimensions: 1100 x 800 x 360 mm

Weight: 80 Kg

Models:

H0270 Flexural strength test frame for 150 kN, equipped with manual load degree adjustment and analogue display.

H0271 Flexural strength test frame for 150 kN, equipped with manual load degree adjustment and digital display.



Compression test machine for pipes

These diameter compression test machines for concrete pipes are made up of a sturdy frame of steel beams joined by high strength bolts that allow easy disassembly. The upper cross-head is moved by a manual winch (motorised on request), and locked at the desired height with pins that pass through the two vertical columns. The motorised hydraulic unit includes manual load adjustment, fast approach valves and flow adjustment.

H0280 Machine of 200 kN capacity for compression tests on pipes,

supplied with a hydraulic power pack and manual approach winch for the top cross-head. The applied load display is digital. The distance between the bottom supports can be adjusted.

Maximum pipe dimensions: 900 x 1800 mm

Dimensions: 3000 x 2300 x 4500 mm

Power supply: 220-240 V. 50 Hz Single phase.

H0281 Machine with 400 kN capacity for compression tests on pipes, supplied with a hydraulic power pack and manual approach winch for the top cross-head. The applied load display is digital. The distance between the bottom supports can be adjusted.

Maximum pipe dimensions: 2850 x 2000 mm

Dimensions: 3200 x 2500 x 5500 mm

Power supply: 220-240 V. 50 Hz Single phase.



Calibration instruments

Reference	kN	Dimensions
H0305	50	120x63 mm
H0306	100	120x44 mm
H0307	300	140x200 mm
H0308	600	140x200 mm
H0309	1000	140x200 mm
H0310	2000	140x200 mm
H0311	3000	140x200 mm
H0312	5000	170x280 mm

Load cells consisting of a steel block on which the extensometers are mounted, all within a protective casing. The force to be measured acts on the sensitive element and slightly deforms it. The variations in resistance of the extensometers are directly proportional to the applied load and measured by an instrument with a digital display. The advantages of these force transducers are their high precision and repeatability. These components are supplied with a calibration certificate, connectors and 2 m of cable.

H0315 Digital force display, designed and manufactured for connection to load cells for test machine control and calibration. Built with state-of-the-art digital microprocessor technology to provide highly stable readings and long-term calibration. Supplied with accessories and a carrying case.

Dimensions: 450 x 350 x 160 mm
Weight: 8 Kg



H0316 Portable printer

ENAC calibration laboratory The machine should be checked with standard equipment at regular intervals to guarantee reliability of results and accuracy of force precision to the materials during testing. PROETI has a laboratory certified by ENAC for force tests.



Concrete permeability and water absorption

Standards UNE EN 12390-8, EN 12364; DIN 1048; ISO 7031; ENV 206

Concrete water penetration test

Concrete permeability can be determined in a laboratory by applying water to the surface of concrete test specimens with specific dimensions at a controlled pressure and subsequently measuring the amount of water that has penetrated into the specimen.

The test is carried out by placing the specimen in a special chamber with adjustable height and locating the specimen between the top plate and bottom joint that delimit the test surface. Then the surface (100 mm) is subjected to water pressure for the time period specified in the standard. A precision pressure gauge is used to control the water pressure applied by a 10 bar compressor that can be ordered separately.

PROETI has several versions available for the test, for carrying out on cubic specimens with sides measuring 20, 15 or 10 cm.

H0330 Water penetration testing equipment for three specimens.

Equipment for testing cylinder specimens with sides measuring \varnothing 150, 100 and 75 mm or cubic specimens with sides measuring 150 and 100 mm and the following construction characteristics:

Compact construction.

Threaded rods to attach test specimens. These elements guarantee perfect securing to the test bench.

Rust proof material on parts in contact with water:

Stainless steel fixing rods.

Stainless steel fastening plate.

Stainless steel water collector

A simple control for each testing unit.

Retainer valve with 2 positions to simplify the operation.

Separate circuits for every three test specimen positions, adjustable with a precision valve and appropriate pressure gauge for calibration.

Sealing ring to ensure the test positions are airtight.

Dimensions: 1500 x 1600 x 530 mm

Weight: 150 Kg.

Supplied as described, with accessories for cylinder test specimens measuring \varnothing 150, 100 and 75 mm



H0331 Water penetration testing equipment for six specimens

Equipment with characteristics similar to those of model H0330, but capable of working with 6 test specimens simultaneously.

H0330/1 Compressor

Air compression limit: 10 bar.

Constant pressure: 8 bar.

Power supply: 220 V. / 50 Hz.

Approx. weight: 21 Kg

H0330.7 Rubber seal for cylinder moulds of the permeabilimeter

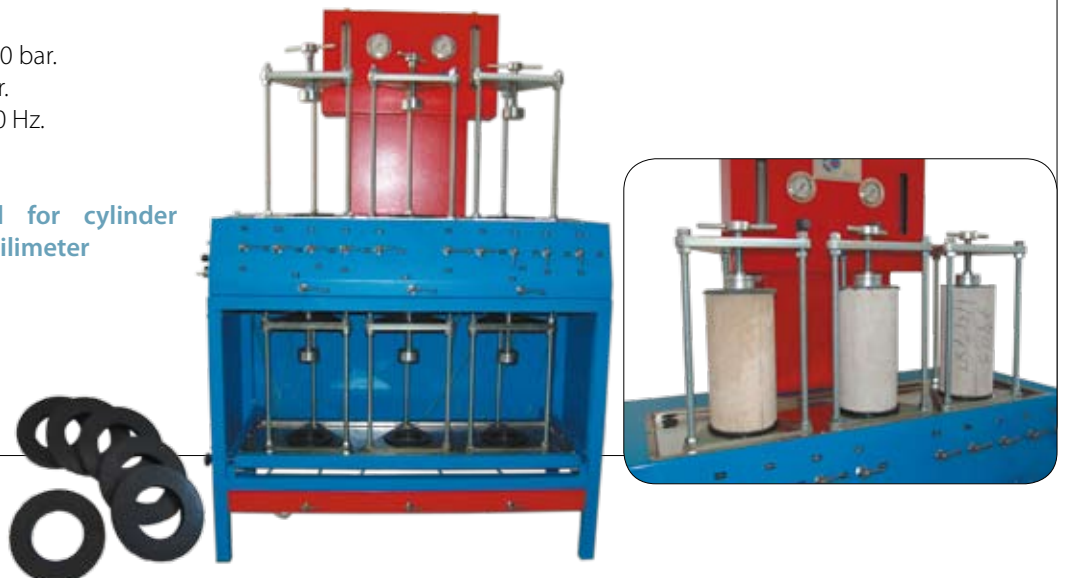

Concrete contraction test

This test is performed to determine hydraulic axis contraction in concrete test specimens of aggregates measuring up to 30 mm

Standards UNE 83318; ASTM 490; BS 1881

H0345 Mould

For manufacture of test specimens measuring 10 x 10 x 50 cm to determine concrete hydraulic axis contraction. Made of steel with ground interior surfaces.

Accessory:

H0345/1 Steel points for fitting to the mould (10 units).



H0346 Apparatus for measuring hydraulic contraction in concrete

In specimens measuring 10 x 10 x 50 cm, with a steel base, a comparator measuring 10 x 0.01 mm, and invar bar.

Adherence test – Beam Test

Moulds

H0350 Steel mould, for adherence tests on bars with \varnothing less than 16 mm. Supplied with base supports and comparators.

Spare parts:

H0350/1 Locking device for H0350 mould.

H0351 STEEL MOULD, for adherence tests on bars with \varnothing greater than 16 mm. Supplied with base supports and comparators.

Spare parts

H0351/1 Locking device for H0351 mould.

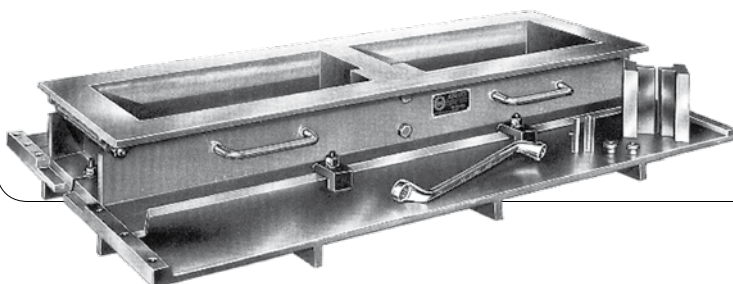

Non-destructive tests

Rebound Concrete Test Hammers

Standards UNE EN 12504-2; DIN 1048; ASTM C805; BS 1881; NF P18-417

This method is based on the principle that the rebound of an elastic mass depends on the hardness of the surface that it strikes. There are various models of esclerometer, with different springs for various types of concrete. The test is fast and does not damage the concrete in any way. The method is sometimes used along with ultrasound equipment.

H0360 Test Hammer

To measure the compression strength of normal concrete of various makes and sizes. Supplied with emery stone, case and instruction manual.

Percussion energy: 2.207 Nm.

Measurement range: 5 to 120 N/mm²

Weight: 1.7 Kg

Accessories

H0369 Calibration anvil, to verify the reading of the esclerometers.



H0362 Test Hammer

To test on walls less than 120 mm thick or artificial rocks.

Percussion energy: 0.735 Nm (0.075 Kgm).

Weight: 1.4 Kg

Accessories

H0369 Calibration anvil, to verify esclerometer readings.



H0367 Low percussion energy hardness tester

Designed to perform non/destructive tests on mortar, low strength materials and concrete thicknesses less than 10 centimetres to assess their compression strength.

Impact energy: 0.735 Nm.

Supplied with carrying strap, emery stone and instruction manual.

Weight: 1.4 Kg

H0368 Wood hardness tester

The only esclerometer on the market that provides reliable onsite evaluation of wood quality.

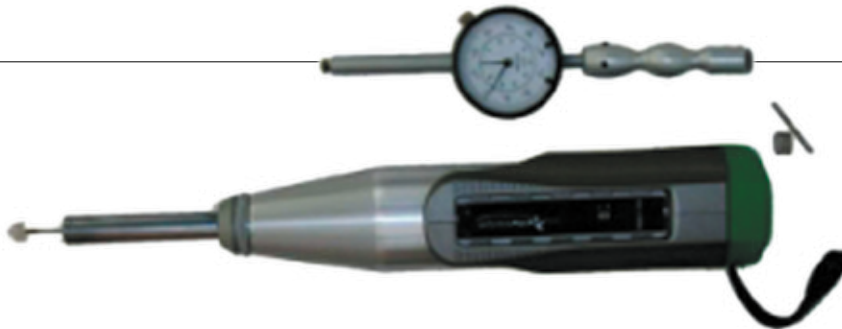
H0375 Digital Concrete Test Hammer

Designed to perform non-destructive tests on concrete uniformity, and to estimate its compression strength. The esclerometer strikes the concrete with a specific force, the rebound depending on the hardness of the concrete. The rebound "R" is measured by a sensor and displayed and processed on the display unit.

Display unit with non-volatile memory up to 20000 values.

LCD 64 x 124 mm graphic screen with RS 232C output.

Temperature range: -10° to +60°C.

Powered by 5 LR6 1.5 V. batteries with 60 h operation.

Impact energy: 2.207 Nm.

Measurement range: 10 to 120 N/mm² compression strength.

Supplied with: cable, carrying strap, emery stone and instruction manual.

Dimensions: 330 x 80 x 100 mm

Weight: 1.8 Kg





Standards ASTM C803; BS 1881

Windsor probe

This method is used to determine concrete strength via the penetration of a steel probe. The probe is fired into the concrete surface and the depth of penetration is measured. Concrete strength can be estimated "in situ", by calibrating the depth of penetration versus compression strength.



H0380 Windsor probe, supplied with propulsion unit, micrometric measuring unit, conversion table and carrying case. The ballistic loads must be ordered separately.

Dimensions: 500 x 250 x 150 mm

Weight: 14 Kg

H0380/1 Silver probe, for tests on concrete with natural aggregates. Pack of 75.

H0380/2 Silver probe, for tests on concrete with lightweight aggregates. Pack of 75.



Crack measurements



H0400 Crack detection microscope

Designed specifically to measure the width of fissures in concrete structures. A high definition apparatus that uses an adjustable light power supply equipped with high power batteries.

Supplied in a carrying case measuring: 40 x 90 x 150 mm

Magnifying power: 35X.

Measurement range: 4 mm

Divisions: 0.02 mm

Standards ASTM C426, BS 1881

H0400 Linear variation measurement

H0405 Analogue deformometer, for surface measurement of linear variations in concrete structures. The unit consists of a 5×0.001 mm comparator, calibration bar, 50 reference discs, glue, user instructions and a carrying case.

Measurement range: 200 mm

H0406 Analogue deformometer, for surface measurement of linear variations in concrete structures. The unit consists of a 5×0.001 mm comparator, calibration bar, 50 reference discs, glue, user instructions and a carrying case.

Measurement range: 300 mm

H0407 Digital deformometer, for surface measurement of linear variations in concrete structures. The unit consists of a millesimal 5 digit comparator, with display in millimetres and inches, a battery charger, calibration bar, 50 reference discs, glue, user instructions and a carrying case.

Measurement range: 200 mm

H0408 Digital deformometer, for surface measurement of linear variations in concrete structures. The unit consists of a millesimal 5 digit comparator, with display in millimetres and inches, a battery charger, calibration bar, 50 reference discs, glue, user instructions and a carrying case.

Measurement range: 300 mm

Spare parts:

H0405/1 Reference discs, pack of 50.

H0405/2 A tube of special glue.



Measuring deflections and sagging

An apparatus to determine deviation, whether tensile or compressive, in buildings, bridges, roofs of any suspended structure. The reading is taken on a comparator gauge. The equipment consists of a hinged support, comparator gauge, plumb and a roll of non-stretch wire.

Models:

H0410 Case for 1 item, 10 x 0.01 mm comparator

H0411 Case for 1 item, 30 x 0.01 mm comparator

H0412 Case for 3 items, 10 x 0.01 mm comparators

H0413 Case for 3 items, 30 x 0.01 mm comparators

H0414 Case for 3 items, one 30 x 0.01 mm comparator and two 10 x 0.01 mm comparators

Accessory:

H0415 Non-stretch wire roll (length 20 m).



Crack monitors, consisting of two plates partially superimposed one over the other. The top plate is stamped with a grid, while the bottom plate is calibrated in millimetres or fractions, marked by the movement of the grid over the bottom plate, beginning at zero.

H0409 Standard crack monitor made of acrylic resin, used to measure vertical and horizontal movement. Supplied in sets of 5.



H0409/1 TT2 angle crack monitor made of hard PVC, used to measure all types of cracks in angles undergoing two-way movement. Supplied in sets of 5.



H0409/2 TT3 floor crack monitor made of hard PVC, used to measure sinking or settling. Supplied in sets of 5.



H0409/3 TT4 crack monitor made of hard PVC, used to measure loss of flatness affecting any cracked surface. Supplied in sets of 5.



Bolt removal strength test

Standards EN 1542, 12504-3; ASTM C900; BS 1881:207

Bolt removal equipment

H0500 Manual bolt removal equipment

Used to measure concrete strength by applying extraction force on a preinserted bolt inserted in the concrete before setting. Hand operated hydraulic remover for bolts measuring up to 32 mm Ø and 200 kN capacity. The unit includes a hydraulic hollow piston, a calibrated aneroid pressure gauge and hydraulic components (hose, pump, rapid connectors...) without accessories.



H0501 Manual bolt removal equipment

Similar to model H0500, 300 kN capacity.

H0502 Manual bolt removal equipment

Similar to model H0500, 500 kN capacity.

H0505 Electrical-hydraulic bolt removal equipment

Used to measure concrete strength by applying extraction force on a preinserted bolt inserted in the concrete before setting. Electrical-hydraulic remover for bolts measuring up to 32 mm Ø and 200 kN capacity. The unit includes a hydraulic hollow piston, a calibrated aneroid pressure gauge and hydraulic components (hose, motor pump unit, rapid connectors...) without accessories.

H0506 Electrical-hydraulic bolt removal equipment

Similar to model H0505, 300 kN capacity.

H0507 Electrical-hydraulic bolt removal equipment

Similar to model H0505, 500 kN capacity.

H0510 Electrical-hydraulic bolt removal equipment with digital display.

Used to measure concrete strength by applying extraction force on a preinserted bolt inserted in the concrete before setting. Electrical-hydraulic remover for bolts measuring up to 32 mm Ø and 200 kN capacity. The unit includes a hydraulic hollow piston, a digital display, a pressure sensor and hydraulic components (hose, motor pump unit, rapid connectors...) without accessories.

H0511 Electrical-hydraulic bolt removal equipment with digital display.

Similar to model H0510, 300 kN capacity.

H0512 Electrical-hydraulic bolt removal equipment with digital display.

Similar to model H0510, 500 kN capacity.

Accessories and spare parts:

H0515 Cone-shaped clamp Ø 12 mm

H0515/1 Cone-shaped clamp Ø 16 mm

H0515/2 Cone-shaped clamp Ø 20 mm

H0515/3 Cone-shaped clamp Ø 25 mm

H0515/4 Cone-shaped clamp Ø 30 mm

H0515/5 Cone-shaped clamp Ø 32 mm

H0516 Cone-shaped clamp holder for clamps up to Ø 25 mm

H0516/1 Cone-shaped clamp holder for clamps up to Ø 32 mm



Pull-off test

Standards UNE EN 12618-2; EN 1542; UNE EN 12504-3

This test method uses a dynamometer to provide information about adhesive force and tensile strength for several layers of material: limes, plaster coating, mortar, cement and concrete. The test consists of making a round cut with a small drill measuring \varnothing 50 mm and then glueing a test disc over the cut with rapid glue. The disc is removed with the "Pull-Off" test apparatus that indicates its strength directly in N/mm^2 or in kN. All models are supplied with a carrying case, a test disc and a draw pin.

Models with pressure gauge

H0435 Pull-off, capacity: 5 kN (recommended for cements and plasters).

H0436 Pull-off, capacity: 16 kN.

H0437 Pull-off, capacity: 25 kN.

Models with an electronic unit

H0440 Pull-off, digital, capacity: 5 kN.

H0441 Pull-off, digital, capacity: 16 kN.

H0442 Pull-off, digital, capacity: 25 kN.

Accessories

H0445 Test discs \varnothing 50 mm (10 units).

H0445/1 Test discs \varnothing 20 mm (10 units).

H0446 Tungsten carbide drill \varnothing 50 mm

H0446/1 Tungsten carbide drill \varnothing 20 mm

H0453 Metolux glue, 1 Kg



Concrete ultrasonic monitoring

Standards EN 12504-3

The velocity of propagation of a material depends on its density and elasticity. These, in turn, are linked to the quality and strength of the material. As a result, information regarding material component properties can be obtained by ultrasound:

Concrete uniformity.

Holes, cracks, defects caused by fire or ice.

Elastic modulus.

Concrete strength test.

H0394 Ultrasonic Tester

Portable ultrasonic equipment with the following characteristics:

Measuring range: 0-9999.9 μ s.

Resolution: 0.1 μ s

Accuracy: + 0.1 μ s

Display of distance between probes.

Propagation speed measurement: m/s.

Storage in memory up to 50 readings.

Data output RS232C (Windows hyperterminal)

TRG and OUT outputs to view on an oscilloscope.

Battery life: 12 hours with 2300 mAh batteries

Screen: Feedback LCD with two lines (for operation in low light conditions).



The apparatus is supplied in a case for transport, including a carrying case, two 150 kHz probes, two 150 cm connection cables, a standard block, coupling paste, rechargeable batteries, battery charger, RS232C cable.

H0395 Ultrasonic Tester

Portable ultrasonic equipment with the following characteristics:

Measuring range: 0-1999.9 microseconds.

Operating temperature: -5 + 40°C.

Empty battery indication: flashing digits.

Maximum charging time: 8 hours.

Weight: 4 Kg

Dimensions: 310 x 290 x 110 mm

Cable length: 3.5 m.

Probe: piezoelectric crystal 55 kHz.

The apparatus is supplied in a carrying case along with two piezoelectric probes, a standard cylinder to check instrument settings, coupling paste and oscilloscope connection cables



H0396 NDE360 UPV Ultrasonic Equipment

Ultrasonic equipment to measure the velocity of propagation of ultrasound pulses in concrete, wood, masonry or rocks. The equipment consists of two piezoelectric transducers, a transmitter and receiver that generate and receive compression waves (P) and optionally shear waves (S). In compliance with ASTM C597.

Used in: Structural elements with two accessible sides, such as walls, screens, columns, etc.

To determine: Cracks, cavities, holes, lean concrete, etc.

Available models:

UPV-1 Includes two submersible 54 kHz transducers.

UPV-1S UPV option with shear waves.

Characteristics and advantages

- 4-channel multiplexer
- Portable and tough
- Colour touchscreen
- Back light
- 6-8 hours of operation (battery)
- 2 GB Flash memory
- Fast keys for Test, Accept and Reject
- Windows-software WINTFS for analysis

The equipment not only records arrival times or velocities of propagation, it also records the entire signal so that it can be studied or processed by software subsequently. Supplied with two water-resistant probes. As an option shear wave-sensitive probes can be supplied.



Rebar locator and corrosion monitors

In the construction industry, locating metal rebars and pipes in concrete structures is essential for the maintenance process. Damage caused by drilling through pipes can be substantial. When a drill strikes a metal rebar or joint, the drill bit is normally damaged or broken and the structure in the concrete can suffer serious damage.

Before performing maintenance, it is vital that the location and orientation of metal rebars and the thickness of the concrete layer are established. It is also useful to find out the current condition of the metal structures and identify cases of corrosion. This will be helpful during the progress of the maintenance tasks.

H0385 BH rebar locator

This instrument is easy to use and very accurate. It is used to locate and find the orientation of rebars and to measure the thickness of the overlying layer of concrete. The detector boasts a water-resistant (IP65), sturdy design, for use in the most demanding situations.

Fast and accurate: It quickly locates and determines the orientation of metal rebars in concrete.

Corrosion verification: The same instrument can be used to check probabilities of corrosion in rebars within the concrete structure.

Large easy-to-read illuminated screen: Easy to read data even where there is little or no light.

Interchangeable detection heads and half cell kits: Standard selection of detection heads with narrow corners, very thick, depth probe, copper half cell kit and silver half cell kit.

One handed operation: 4 key access and control of most functions.

Multilanguage menus: Choose your own operating language.

International rebar sizes: User choice of rebar sizes in metric, USA, ASTM/Canadian and Japanese systems.

Rechargeable battery: The batteries can be charged while inside the instrument or externally.

Ergonomic design: Designed for user comfort, the device can rest against the hip while taking measurements.



Rebar locators

H0386 SH rebar locator

This instrument is easy to use and very accurate. It is used to locate and find the orientation of rebars and to measure the thickness of the overlying layer of concrete. Auto-size mode to detect rebar diameters. Recording of up to 10,000 readings. The detector boasts a sturdy water-resistant (IP65) design for use in the most demanding situations.

Fast and accurate: It quickly locates and determines the orientation of metal rebars in concrete.

Corrosion verification: The same instrument can be used to check probabilities of corrosion in rebars within the concrete structure.

Large memory capacity: Recording of up to 10 linear batches of 1,000 readings each.

Large easy-to-read illuminated screen: Displays graphs, statistics, batches and numeric data and readings.

Interchangeable detection heads and half cell kits: Standard selection of detection heads with narrow corners, very thick, depth probe, copper half cell kit and silver half cell kit.

Covermaster® software: State-of-the-art data management to save readings of concrete layers and half cells, as well as fast and easy professional report generation.

Multilanguage menus: Choose your own operating language.

International rebar sizes: User choice of rebar sizes in metric, USA, ASTM/Canadian and Japanese systems.

Rechargeable battery: The batteries can be charged while inside the instrument or externally.

H0387 TH rebar locator

This instrument is easy to use and very accurate. It is used to locate and find the orientation of rebars and to measure the thickness of the overlying layer of concrete. Auto-size mode to detect rebar diameters. Recording of up to 240,000 readings. The detector boasts a sturdy water-resistant (IP65) design for use in the most demanding situations.

Fast and accurate: It quickly locates and determines the orientation of metal rebars in concrete.

Corrosion verification: The same instrument can be used to check probabilities of corrosion in rebars within the concrete structure.

Large memory capacity: Recording of up to 10 linear batches of 1,000 readings each.

Large easy-to-read illuminated screen: Displays graphs, statistics, batches and numeric data and readings.

Interchangeable detection heads and half cell kits: Standard selection of detection heads with narrow corners, very thick, depth probe, copper half cell kit and silver half cell kit.

Covermaster® software: State-of-the-art data management to save readings of concrete layers and half cells, as well as fast and easy professional report generation.

Multilanguage menus: Choose your own operating language.

International rebar sizes: User choice of rebar sizes in metric, USA, ASTM/Canadian and Japanese systems.

Rechargeable battery: The batteries can be charged while inside the instrument or externally.

Accessories

H0388/1 Standard detection head. Designed to cover all your measuring needs.

H0388/2 Narrow angle detection head. Accurate measurement of the overlying concrete layer when the space between each rebar is very narrow

H0388/3 Deep detection head. The ideal detection head to accurately measure rebars located at the bottom of the structure.

H0388/4 Depth probe. The ideal solution for locating joining pipes and multiple levels of metal rebars within a concrete structure.

H0388/5 Extension kit. This kit is used to check or scan bridge roofs and floors from a standing position. It can be connected to the standard detection head or a narrow angle detection head.

H0388/6 Half-Cell Probe Kit. The half-cell probe kit comes with a copper electrode bathed in copper sulphate (Cu/CuSO₄) or a silver electrode bathed in a silver chloride solution (Ag/AgCl). Each cell is airtight and does not need to be mixed with any other chemical component when applied. Supplied with a 25 m (80 ft) cable and a 5 year warranty for each kit.



Non-destructive tests on concrete

Standards ASTM C215, C666; BS 1881:209; NF P18-414

H0483 Resonant frequency meter

This equipment consists of 3 very simple components, the measuring unit, hammer and accelerometer. This RT-1 digital unit is fast, simple, easy to operate and more economic than old analogue vibrator units. It complies with the ASTM C215 concrete resonant frequency test to determine dynamic properties and durability versus freeze-thaw cycles (ASTM C666). Young's dynamic modulus (E), shear modulus (G) and Poisson's ratio (ν) for concrete, rock, masonry, coal and any other cylindrical material, beams or specimens can be obtained in seconds. Standard equipment includes a worksheet to calculate all the moduli, length, bending and torsion.

Characteristics

- Accurate results in seconds.
- High resolution colour screen
- Can be learned in under 10 minutes
- Damping Calculation.
- Data download & analysis in a PC via RS232C.
- AC (100-240 VAC) or rechargeable batteries
- Can be used for testing small specimens.
- Easy, quick to use. Uses plastic materials in compliance with ASTM C215.

Equipment & Software:

- Portable equipment
- Accelerometer.
- BNC Microdot cable.
- Round head hammer.
- Test specimen holder.
- Accelerometer holder kits.
- Small specimen impactor.
- Adhesive/Spatula.
- Carrying case.
- Calculation worksheet.
- Software for downloading, processing and analysis.



H0484 NDE 360 Equipment

Low cost system with 8 available tests for pavement, structure tests, foundations and seismic geophysical profiles:

NDE 360 SE
 NDE 360 IR
 NDE 360 SEIR
 NDE 360 SIR
 NDE 360 SASW-S
 NDE 360 SASW-G
 NDE 360 UPV
 NDE 360 PS
 NDE 360 IE

Characteristics and advantages

4-channel multiplexer
 Portable and tough
 Colour touchscreen
 Backlight
 6-8 hours of operation (battery)
 2 GB Flash memory
 Rapid keys for Test, Accept and Reject
 Windows-software WINTFS for analysis

Specifications

Converter: A-D 16 bits.

2 Microseconds, 500 kHz sampling speed on two channels

Nyquist maximum frequency: 250 kHz

Gain values can be selected per channel separately: x1, x10, x100 x1000.



The NDE 360 is a sturdy, rugged apparatus powered by 8 batteries for END tests. To complete the NDE 360 system, choose one of the following options:

- Pavements, Structural Tests and Tunnels
- Echo Impact
- Surface wave tests
- Speeds in pre-manufactured panels (defects)
- Ultrasound pulse speed
- Data collection for computerised tomographic speed imaging
- Equipment for monitoring foundation integrity and depth
- Time and/or frequency domain monitoring systems (ASTM D5882)
- Parallel seismic analysis
- Ultraseismic analysis
- Surface seismic wave systems (Geophysics)
- Surface wave test

New tests can be added to the equipment from the initial configuration.



H0484/5 NDE 360 SASW-S

Equipment used to determine rigidity, speed and thicknesses in layered systems (normally not exceeding 3 metres) without making holes (specimens) and with one accessible side. The SASW method is a powerful tool used to identify changes in the properties of materials at a variety of depths in a layered system.

Used in:

Pavement, concrete blocks, tunnels, structural concrete. Study of fire damage, freezing. Depth of damaged concrete. Estimation: strength of concrete, masonry and rocks with non-destructive correlation. Study of concrete depth (gunite thickness) and competence along the length of a tunnel.

Available models:

SASW-S Supplied as shown with two accelerometers and an SASW bar.

SASW-S+G Similar to the above with a triaxial geophone



H0484/6 NDE 360 SASW-G

Equipment used to prepare speed profiles and measure thicknesses of soil layer systems located over rock.

Used in:

Study of subsurface rock and soil up to a depth of 33 metres. Determination of speed profiles and thickness of soil layer systems located over rock.

Available models:

SASW-G2 2 data channels with 4 geophones: (2) 1 Hz and (2) 4.5Hz

SASW-G4 4 data channels with 8 geophones: (2) 1 Hz and (2) 4.5Hz

SASW-G8 8 data channels with 8 geophones: (4) 1 Hz and (4) 4.5Hz



H0484/8 NDE 360 IE

Equipment used to study concrete, mortar and masonry integrity. This equipment also measures the thickness of these elements

Used in:

Floors, beams, highways, tunnels, dams, columns, walls, screens, etc.

Detection of:

Thickness, cracks, cavities, delamination, beehives.

Available models:

IE-1 Includes hand equipment with solenoid impactor and displacement transducer (measures thicknesses from 6 cm to 40 cm)

IE-W Similar to the above but submersible
IE-2 Combines the IE-1 with an instrumented hammer and an accelerometer, thicknesses from 6 cm to 100 cm concrete

IE-T IE-1 equipment with a second transducer for thickness measurements, in compliance with ASTM



H0484/4 NDE 360 SIR

Equipment used to study structural supports, internal delamination, fractures, cavities and structural integrity.

Slab impulse response

For use in concrete slabs, concrete pavement, tunnels, premanufactured elements and structural concrete elements in general.

The Slab Impulse Response (SIR) consists of striking the structure with an instrumented hammer and recording the structural vibration with a geophone. Highly flexible, mobile responses indicate deficient supports and structural damage.

Available models:

SIR-1 Includes instrumented hammer (1.4Kg), 4.5 Hz geophone and transducer multi-axis.



H0484/1 NDE 360 SE-1, H0484/2 NDE 360 IR-1, H0484/3 NDE 360 SE/IR

Equipment used to study pile integrity in time and frequency domains. Used in: Driven piles and piles manufactured onsite

Detection of: Cracks, cavities, soil intrusion, washed concrete, uncured concrete, section variations, etc.

Monitoring pile integrity and depth

Available models:

1. NDE 360 SE-1 shows echoes in time domain

2. NDE 360 IR-1 shows echoes in frequency domain

3. NDE 360 SE/IR: Combines the SE-1 and the IR-1, simultaneously showing the curves in the time and frequency domains. Supplied with instrumented hammer and accelerometer.

4. NDE 360 SE/IR/PS-1 Echo/Impulse/Parallel seismic. Combines the SE-1 and the IR-1 with hydrophones.

5. NDE 360 SE/IR/PS-1G: Echo/Impulse/Parallel seismic. Combines the SE-1 and the IR-1 with hydrophones + Geophone system consisting of a hydrophone and triaxial geophone + IX software



H0484/7 NDE 360 PS

Equipment used in parallel seismic tests. Used to determine pile or foundation depths, even when the head is not accessible.

Measurement of depth, foundation type to determine unknown foundation depths even when the tops (heads) are not accessible.

Available models:

1. NDE 360 PS-1 Includes 1-Hydrophone and IX PS software

2. NDE 360 PS-1G Includes 1-Hydrophone, a triaxial geophone and IX PS software



Non-destructive tests on concrete. Pile integrity

H0484/9 NDE 360 US

Equipment used to measure pile depth (length). Used to determine pile and/or foundation depths when the head is accessible.

Used in:

Piles, bridge and harbour pillars.
Measurement of unknown depth of foundations and piles. It requires that the head or top part be partially exposed.

Available model:

US-1 Includes a triaxial receiver, instrumented hammer and IX US software.



H0460 IT-System Equipment

Supplied with Windows software, RS-232 connection cable, transducer, power plug-adaptor, hammer, printer cable, modem cable and carrying case.

The Integrity Test (IT-System) is used to determine irregularities and/or failures in concrete piles, locating the exact place of the failure. The IT-System can be run by a single operator and test more than 60 piles in one hour. The test is performed by resting a transducer or geophone on the head of the pile and striking the head with the hammer supplied for that purpose. The IT system records the hammer impact followed by the response from the pile and shows both results. If the operator wants to, he can store the signal in the unit memory, including all the information regarding the pile identification number, day, time, place, magnifying factor, filter length, etc. The operator can print the results or connect the equipment to any computer with Windows to transfer or analyse the results or send them to a printer or plotter.



Non-destructive tests. Vibration measurement

The VIBRA system automatically measures vibrations continuously in three perpendicular directions. The system records maximum vibration and frequency values. It operates on standard batteries (for 1 month) and automatically sounds an alarm when a vibration level is surpassed.

The VIBRA system is easily installed by connecting the sensor to the object to be tested and pressing a key. The display shows the day and time and the vibration recorded at that moment. The keypad can be used to review the memory and the maximum level of recorded vibration.

This equipment is during pile driving, pile installation / removal, construction and demolition work, studies on the effects of heavy traffic, speed bands, movement of machinery

Characteristics:

- Sturdy build
- Compact, lightweight
- Reflection and scratch-resistant screen
- Alkaline D batteries
- USB port
- Lightweight geophone with levelling ball
- Wide speed range (0-100 mm/s)
- Vibration frequency recording: 0.8 - 100 Hz
- Totally standards compliant
- Digital geophone detection (digital ID)
- Digital input of vibration codes
- Optional: data, status and alarm via email GPRS/internet
- Complies with Standards (DIN45669, DIN4150, SBR) 'Vibrations in buildings'

H0465 VIBRA equipment, supplied with the following components:

- 3D transducer with cable and waterproof field case.
- RS-232 connection cable.
- Windows software.

H0466 VIBRA + equipment, supplied with the following components:

- 3D transducer with cable and waterproof field case.
- RS-232 connection cable.
- Windows software.



Non-destructive tests. Pile driving (PDA-System)

The PDA-System is used to measure the force and acceleration of each impact during the pile driving process. This measurement system is used mainly to check pile strength. The idea is to offer operators immediate, detailed information regarding soil resistance. The main purpose is to avoid unnecessary driving in order not to disturb the surroundings. The equipment has an accelerometer equipped with specially developed electronics that firmly adheres to the pile. Data are collected by a computer with a WINDOWS system and special software that calculates displacement speed, dynamic strength, etc., in real time. The accelerometer must be secured to one of the faces of the pile (near the head), with a cable connecting the accelerometer to the PC, where the data are processed and displayed on the screen.

H0470 PDA-System Equipment

The equipment includes PDA software, two voltage indicators, two accelerometers, a connection box, cable and cable holder (50 m) and instruction manual.

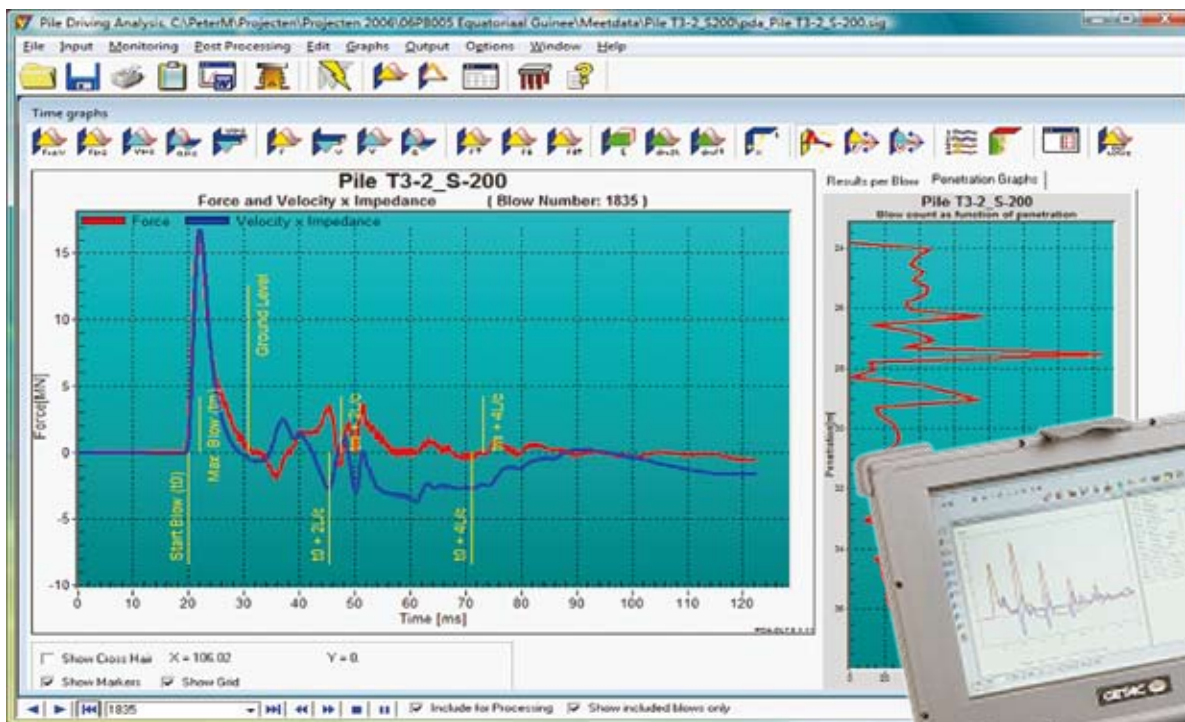

Cross-hole equipment



The Cross-hole test system, or CSL, is used to test a wide range of foundation structures, from piles manufactured “in situ” to walls. A structure can only be tested if it can be accessed by pipes and probes, in such way that the probes can be introduced through the pipes. When used as a system for checking structure quality, it becomes a powerful instrument for the detection and evaluation of all kinds of defects that affect concrete integrity.

The Cross-hole testing system (CSL) – The CSL testing system consists of propagating ultrasound waves through two or more access pipes. These pipes are previously filled with water to measure the speed and energy of the propagated waves. The test can be carried out for any kind of foundation or concrete structure that has two or more access pipes (or probes) that can hold water. The CSL can also be applied to submerged piles and structures that do not have internal pipes but can be fitted with external pipes. The computer tomographic imaging tests are carried out when the defects detected are critical and require an in-depth study.

The Crosshole sound profile system consists of 4 basic components. These four components are: a portable Freedom Data PC

with a high speed data collection card, the CSL software for data collection and analysis, the CSL modules of the impulse generator and the amplifier; a lowering / lifting unit with depth meter; and two transducers. These components are inter-connected by cables to form a complete system.

Easy collection and analysis of digital data with the battery-powered laptop.

Computer imaging (2D and 3D) of the pile and defects by software (speed).

All the data and tests are stored in the hard disc.

Output for printer and optional portable field printer.

Real time display of test results with clear presentation of the time signal, speed and/or energy, as well as classic bands and computer imaging.

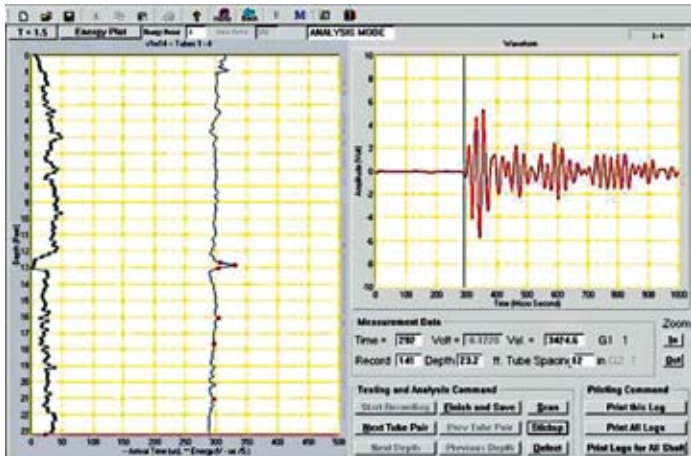

Software

The software enables completely automatic operation, both for adjustment of equipment and the detection and delimitation of defects. Colour frames are used for clear identification of sound concrete as opposed to damaged concrete. The CSL software is a program that measures the first signal arrival in real time. It can collect data simultaneously through one (CSL-1) or two channels (CSL-2). The software can also be used with computer imaging programs and use computer imaging data to obtain 2D and / or 3D images of the defects (TOMO-1 software, optional). This software can be run manually or automatically by the user. The basic equipment provides testing distances of up to 6 metres of concrete.

Internally powered by 12 VDC batteries, external 12 VDC (car charger) or directly plugged into the mains.

CSL-1 for a single time recording or CSL-2 for two recordings at the same time.

Crosshole test

Monitoring of concrete works by ultrasound is not new in the field of non-destructive testing. The test consists of generating an ultrasound signal and receiving it at a known distance. The width of the signal from the time of transmission to the time of reception provides the elastic characteristics of the material to be tested. Two or more metal pipes are anchored to a reinforcement inside the work piles, and fastened so that they are diametrically opposite each other.

For each pair of pipes, the measurement is performed by two probes placed at the same depth; one of them generates the sound signal and the other one receives it. The measurements are made by having the probes removed from the length of both pipes at the same time. The acoustic coupling between the two probes and the concrete pile is essential. This coupling is performed by filling the measurement pipes with water.

The diagrams obtained by using this method are very uniform and show the depth and possible defects of the pile with great accuracy. The technique adopted for signal display allows for rapid interpretation of concrete characteristics and pile execution.

H0480 Crosshole testing equipment (CSL- 1)

With the following components:

Freedom data PC, a weatherproof industrial laptop computer with Windows XP / Windows Vista, TFT high contrast colour screen, large capacity hard disc, Pentium mobile or equivalent, network card, USB ports, external connections for VGA, COM1, LPT1, etc.

CSL1 software for data recording and processing and automatic generation of reports in Office.

Ultrasound wave transmitter and receiver measuring $\varnothing 1.5''$ or special probes with much smaller diameters.

The probes are entirely interchangeable and can be used as transmitters or receivers.

An ultrasound pulse generator to excite the transmitter, with synchronised activation systems to initiate the recording system.

Equipment to determine recording depths.

Encoder / pulley to lift the probes.

Tripod.

Two cable coils for 80 metres of usable cable.

Amplifying systems and cabling for the CSL test.

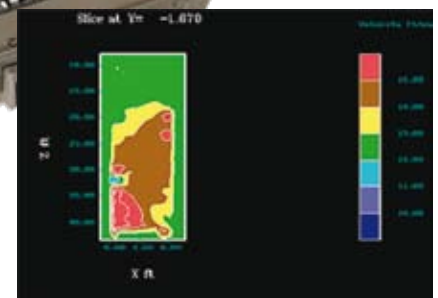

H0481 Crosshole testing equipment (CSL-2)

Similar to the CSL-1 model but equipped with 3 probes for 2 simultaneous recordings.

Crosshole test Down-Hole;Up-Hole in soils and rocks

Standards ASTM D4428-D4428M-00 Crosshole seismic test

CS (Crosshole Seismic) tests are performed to provide information on the dynamic properties of soil, rock, design and analysis of structures to combat earthquakes, studies of liquefaction potential, settling failure and foundation designs subject to dynamic loads. Tests and research provide compression wave and shear wave speed profiles versus depth.

Other parameters such as quotients and Poisson modulus can be easily determined from the measurements of compression and shear wave speeds. In addition, material damping can be determined by CS tests. Apart from CS tests, Downhole Seismic (DS) requiring a single probe can be performed.

The Crosshole Seismic method is a test method that is used to determine soil and rock properties. A power supply capable of generating compression and shear waves is lowered through one of the drill holes. Also lowered are a pair of geophone receptors with 3 equal components (triaxial geophones), to the same depth through 2 additional drill holes made with equal spacing increments (normally 3 and 7 metres from the source perforation) in line, as shown in the picture. The receivers are attached to the sides of the drill hole walls, from where they detect the passage of the compression and shear waves.



Access and Requirements

CS tests require two or more (normally three) drillings / holes. These drill holes generally have a diameter of 3-4 inches and are coated with PVC and grouted to ensure good wave energy transmission. The tests are simplified by using an inclinometer with a box instead of PVC pipe. The typical distance between two adjacent perforations is 3 metres, although this distance is greatly influenced by the type of material.

Drillings / holes for the receiver are made to the total depth to be studied. For tests that use a separating spoon (ex., for specimen collection) as a transmitter, the drillhole advances as the required measurement intervals are defined (equal intervals of 60-150 centimetres) and tested. If a power supply with a hammer attached to the drill hole wall is used, the transmitter hole can be drilled to the total depth to be studied, before the test.

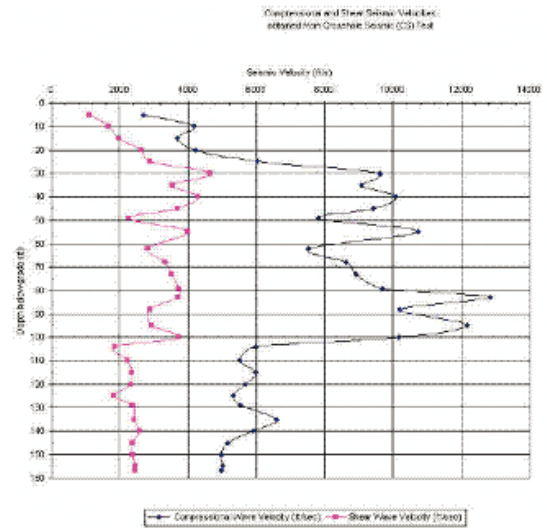

Data collection

For a CS test, the transmitter is lowered to the measurement depth in the hole, this must progress at the same pace as the drill hole. For later tests, one or two receivers (triaxial receivers) are lowered simultaneously to the same depth through the other drill holes. Orientation bars are fastened to the transmitter and receiver, unless sleeved inclinometers are used. The power supply is turned on at the surface to generate the compression and shear waves. In some cases, when a specimen collector is used as the power source, the upper part of the transmitter bars are struck by an instrumented hammer (or the transmitter inside the drill hole is triggered) to generate compression and/or shear waves with enough energy. The vertical component of the receiver is used to capture the shear waves that are vertically polarised (SV). The polarised energy is generated in both directions, which duplicates the data and allows effective measurement of shear wave arrival. The radial component detects the propagation of compression waves (P) and the tangential component detects the shear waves propagated horizontally (SH). The input value of the hammer and/or PS-V source and receiver output are recorded in the Freedom NDT. The drilling continues to the next measurement depth and the transmitter is placed (or lowered to the next measurement depth) and the process continues until all the required measurements have been taken.

In a DS study, the normal source is a hammer that strikes a board on the surface and requires a single drilling. The triaxial geophones, spaced at approximately three metres, are lowered together with the probe (downhole). The source (hammer) generates compression and shear waves that are recorded by the geophone/s. The vertical receiver component is used to capture the compression waves that are propagated vertically (P) and the radial component captures the shear waves polarised horizontally (SH).

Compared with surface methods, the CS test is the most accurate method to determine soil and rock properties. This method can detect thin low speed strata located between high speed strata, which is not possible with surface methods such as Spectral Analysis of Surface Waves (SASW) or Diffraction Study Tests. In addition, the precision and resolution of the CS method are constant at any test depth, while in surface methods these two characteristics diminish at greater depths.

In cases where carrying out 2 or 3 drillings is expensive or not practical, Downhole tests can be performed. If the tests are carried out on rocks, it is not necessary to place the probes in pipes.

H0482/D Downhole test equipment

H0482/U Uphole test equipment

H0482/C Cross-hole test equipment

5

SOILS

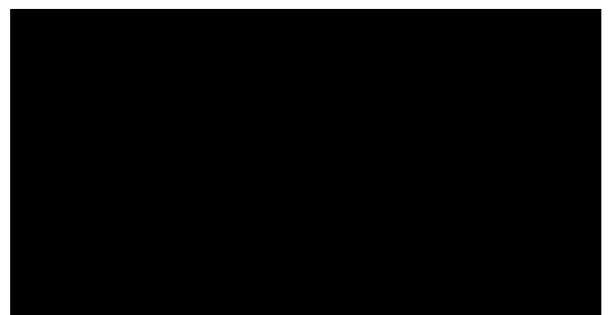

Sampling

S0001 Unaltered terrain sampling equipment

This equipment is used to obtain unaltered samples measuring \varnothing 38 mm. The equipment consists of: A "T"-shaped handle, extendable to 900 mm.

Percussion device.

Stainless steel sampler, \varnothing 38 x 230 mm long.

Accessories:

S0001/1 Sampler made of stainless steel, \varnothing 38 x 230 mm long.

S0001/2 Manual extractor for samples of \varnothing 38 mm.

S0001/3 Extension, 900 mm long.

Standards ASTM D420, D1452; AASHTO T86, T202

Manual core-head bits

Designed for terrain investigation and exploration.

Manufactured in galvanised steel. Supplied with a "T"-shaped handle

Models:

S0002 Manual core-head bit, \varnothing 80 mm

S0003 Manual core-head bit, \varnothing 100 mm

S0004 Manual core-head bit, \varnothing 150 mm

S0001/4 Extension, 1000 mm long.

Standards ASTM D2937; CNR No.22; BS 1377:9

Surface sampler with cutting ring

Used for sampling in compacted terrain or unaltered soil to assess density and degree of compaction.

The equipment consists of a hammer that slides on a rod and strikes a head which houses a sample collector pipe with a cutting edge. Made of anti-corrosion cadmium steel.

Models

S0006 Soil sampler with pipe of int \varnothing 73 x 66 mm long and 5 Kg hammer

Total weight: 10 Kg

S0007 Soil sampler with pipe of int \varnothing 100 and capacity 1/30 cubic feet and 10 Kg hammer

Total weight: 16 Kg

S0005 Motor-powered core-head bit

This equipment is used by an operator for easy, fast collection of altered terrain samples. Powered by a 1.5 Hp internal combustion engine without speed inverter. Equipped with a double handle for use by a single operator. The equipment drills holes of up to \varnothing 200 mm and maximum depth of 1 m

Weight: 10 Kg

Accessories:

S0005/1 Core-head bit measuring \varnothing 60 x 1000 mm long.

S0005/2 Core-head bit measuring \varnothing 80 x 1000 mm long.

S0005/3 Core-head bit measuring \varnothing 100 x 1000 mm long.

S0005/4 Core-head bit measuring \varnothing 150 x 1000 mm long.

S0005/5 Core-head bit measuring \varnothing 200 x 1000 mm long.

S0008 Sampling equipment

Comprising a cylinder with cutting edge \varnothing 130 x 130 mm high, rubber hammer and wooden sleeper for hammering.



Classification of samples

Standards UNE EN 932-1; NLT 148/91; ASTM C136, C702, D271, D421, D492; AASHTO T27, T87; BS 1377, 812

Sample dividers

Used to divide samples into representative parts by means of a series of hoppers. Made of painted sheet metal and supplied with three sample containers.

Models:

S0010 Sample divider with 8 hoppers measuring 3" and 3 containers with handles.

Dimensions: 490 x 880 x 450 mm **Weight:** 24 Kg

S0011 Sample divider with 10 hoppers measuring 2" and 3 containers with handles.

Dimensions: 490 x 760 x 420 mm **Weight:** 18 Kg

S0012 Sample divider with 12 hoppers measuring 1 1/2" and 3 containers with handles.

Dimensions: 400 x 700 x 390 mm **Weight:** 16 Kg

S0013 Sample divider with 14 hoppers measuring 1" and 3 containers with handles.

Dimensions: 325 x 600 x 275 mm **Weight:** 11 Kg

S0014 Sample divider with 16 hoppers measuring 3/4" and 3 containers with handles.

Dimensions: 325 x 475 x 250 mm **Weight:** 10 Kg

S0015 Sample divider with 14 hoppers measuring 1/2" and 3 containers with handles.

Dimensions: 260 x 290 x 230 mm **Weight:** 7 Kg

S0016 Sample divider with 14 hoppers measuring 1/4" and 3 containers with handles.

Dimensions: 150 x 190 x 165 mm **Weight:** 2 Kg

S0017 Universal sample divider, designed to reduce especially large test samples into representative parts. Made of painted sheet metal. Hopper of 11 dm³ capacity opened by a lever mechanism. The bars for adjustment of the opening enable a wide usage range of between 12.7 and 76.2 mm and provide for correct positioning. Supplied with two sample containers.

Dimensions: 550 x 800 x 400 mm **Weight:** 36 Kg



Sample preparation

Sample mixing

These mixers have been especially designed for Certified Laboratories, Technical Colleges and Universities. The rotary action ensures complete, even mixing of material.

S0020 Laboratory mixer with capacity of 14 litres, powered by a 1 Hp electric motor that rotates the material container while the mixing blades remain fixed.

Power supply: 380 V 50/60 Hz, three phase

Vessel dimensions: Ø 360 x 200 mm

Dimensions: 640 x 360 x 860 mm

Weight: 90 Kg

S0021 Laboratory mixer with 10 litre stainless steel vessel. Its rotary action ensures complete, even mixing of material.

Supplied with stainless steel vessel and three different blades.

Vessel capacity: 10 litres

Power supply: 220 V 50 Hz single phase / 380 V 50 Hz three phase

Power: 370 W

External dimensions: 725 x 530 x 360 mm

Weight: 46.5 Kg



S0021



S0020

S0023 Circular bath equipped with thermostat

Double metal body, exterior aluminium body painted in epoxy and 18/10 stainless steel interior vessel.

Heated by a reinforced heating element in AISI 316 stainless steel.

Temperature settings between room temperature and 120°C (200°C, depending on the model) by bulb thermostat.

Equipped with a safety thermostat with manual reset for over-temperatures, in compliance with DIN 12877 class 2.

Includes heating element cover tray.

Control panel with:

- Illuminated start switch.
- Heating element operation pilot light.
- Safety thermostat pilot light.
- Temperature setting selector.

Manufactured in accordance with EU directives.

Voltage: 230v/50H

Capacity: 3 L

Usable dimensions: Ø 180 x 120 mm h

External dimensions: Ø 245 x 245 mm h

Power: 500 W

Maximum temperature: 120 ± 1°C



Sample extractors

The soil sample removal process should alter the sample as little as possible, especially in the case of small specimens that have to be prepared for laboratory testing.



Standards ASTM D698, D1587, D1883; BS 598, 1377.

S0024 Manual hydraulic sample extractor

Used to extract samples for C.B.R, Proctor and Marshall moulds.
Operated manually by means of a hydraulic pump.

Made of galvanised steel.

Supplied with Ø 4" and 6" adapters

Capacity: 50 kN

Dimensions: Ø 300 x 410 mm

Weight: 30 Kg

Standards ASTM D698, D1587, D1883; BS 598, 1377.

S0025 Horizontal mechanical sample extractor

Operated manually, designed for the extraction of samples contained in thin-walled pipes. This sample extractor can be fitted with interchangeable spacers and supports, as well as sample collection pipes of various sizes (up to 900 mm) and diameters (up to 101.6 mm). The adapters must be ordered separately.

Dimensions: 1200 x 460 x 1260 mm

Weight: 65 Kg

Accessories:

Adapters for the sample extractor

S0025/1 2" O.D

S0025/2 3" O.D

S0025/3 101.6 mm O.D

S0025/4 100 mm O.D

S0025/5 88.9 mm O.D

S0025/6 83 mm O.D

S0025/7 101.6 mm

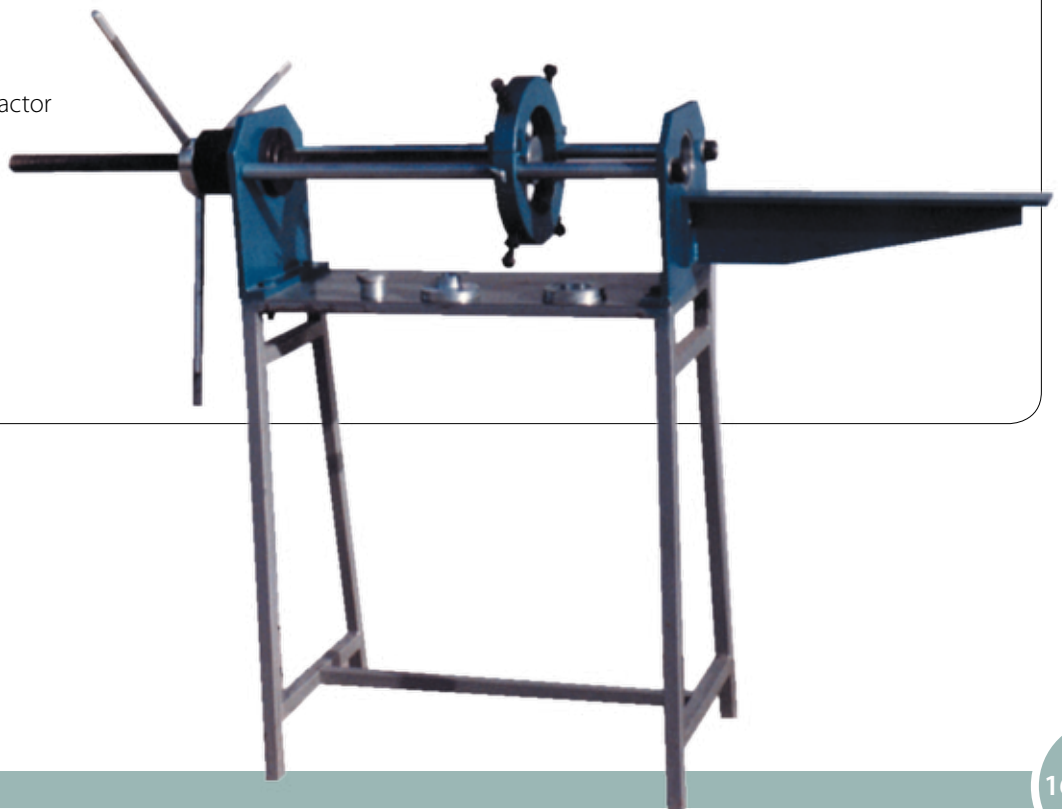

Standards UNE 103.400; ASTM D698, D1587, D1883; BS 598, 1377
S0026 Horizontal mechanical sample extractor

Motor-powered, designed for the extraction of samples contained in thin-walled pipes. This sample extractor can be fitted with spacers and interchangeable supports, as well as sample collection pipes of various sizes (up to 900 mm) and diameters (up to 152 mm). Powered by an electrical motor. Equipped with a variable-speed motor to control the speed of advance of the plate. The pipe is locked down by four screws for perfect centring and stabilising. The adapters must be ordered separately.

Technical characteristics:

- **Power supply:** 380 V / 50 Hz, three phase
- **Capacity:** 70 kN
- **Maximum sample diameter:** Ø 152 mm
- **Adjustable forward speed:** 120 - 1200 mm/min
- **Maximum run:** 900 mm
- **Transport dimensions:** 1200 x 460 x 1260 mm
- **Working dimensions:** 1200 x 460 x 1320 mm
- **Weight:** 110 Kg

Accessories:

Adapters for the sample extractor:

- S0026/1 2" O.D
- S0026/2 3" O.D
- S0026/3 101.6 mm O.D
- S0026/4 100 mm O.D
- S0026/5 88.9 mm O.D
- S0026/6 83 mm O.D
- S0026/7 35 mm
- S0026/8 38 mm
- S0026/9 101.6 mm
- S0026/10 6"



Trimming machines

Standards UNE 103-400
S0030 Cylinder specimen trimming machine

Used to trim cylinder soil specimens with diameters between 38.1 and 100 mm. The top plate is rotated manually and can be adjusted to a height of 100 mm. Supplied with reducer plates for specimens of Ø 38.1 and 50.8 mm.

Dimensions: 430 x 250 x 140 mm

Weight: 10 Kg

Accessories:

- S0030/1 Hacksaw for trimming.
- S0030/2 Knife.
- S0030/3 Adapter plate Ø 35 mm
- S0030/4 Adapter plate Ø 38.1 mm
- S0030/5 Adapter plate Ø 50.8 mm

S0031 Cubic specimen trimming machine

Used to size cubic and prism specimens up to 250 mm long. Made of steel plate with an adjustable fastening clamp and a fixed clamp.

Dimensions: 120 x 100 x 250 mm

Weight: 6 Kg

Accessories:

- S0030/1 Hacksaw for trimming.
- S0030/2 Knife.

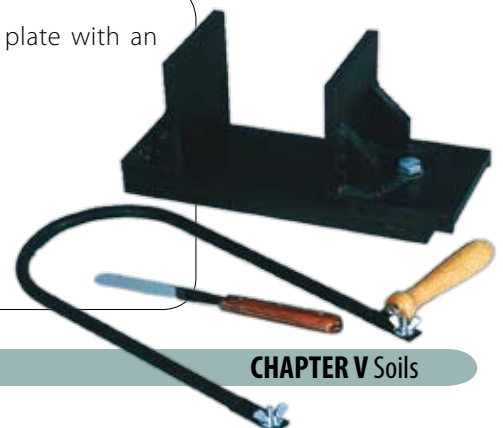

Determining moisture content

Standards ASTM D4944; AASHTO T217; UNE 7804; BS 6576

"Speedy" moisture meter

For fast and accurate determination of humidity content in mixtures and pastes containing soil, sand, clay or other granular materials.

The working principle is based on the reaction between water and calcium carbide, producing an amount of gas that is directly proportional to the amount of water present in the sample. The moisture samples are obtained by the following test method:

- Prepare and weigh the sample using the electronic scale
- Place the sample in the container
- Add the reagent (calcium carbide) in the appropriate place, position the lid and close the vessel.
- Shake the Speedy device to mix the reagent with the sample.
- Read the moisture content indicated on the needle of the device.

Available models

S0033 (S 2000) Speedy Standard moisture meter

Complete with calibrated pressure gauge, electronic scale, waterproof case, cleaning brush, cloth, measuring spoon and instruction manual.

Measurement range: 0-20%

Sample weight: 6 g

Maximum sample size: 10 mm

Case dimensions: 51 x 38 x 20 cm

Weight: 5.5 Kg



S0034 (L 2000) Speedy Large moisture meter

Complete with calibrated pressure gauge, electronic scale, waterproof case, cleaning brush, cloth, measuring spoon and instruction manual.

Measurement range: 0 - 20%

Sample weight: 20 g

Maximum sample size: 20 mm

Case dimensions: 51 x 38 x 20 cm

Weight: 6 Kg



S0032 Calcium carbide, 400 g pack

S0032/1 Speedy calibration equipment





Standards ASTM C70; AASHTO T142

Surface moisture in fine aggregate

S0037 Chapman flask to determine surface moisture in fine aggregate. Graduated to 200 mL between two bulbs and from 375 to 450 mL from the second bulb.
Weight: 500 g

A0568 "Microlance" moisture meter

Electronic apparatus for direct measurement and display of percentage moisture and temperature in sand and fine aggregate with a maximum diameter of 10 mm.

Easy to operate, simply introduce the cross-shaped tip of the device onto the sample to be measured and the results appear on the digital display.

For use "in situ" as well as in the laboratory.

Humidity range: 0-35%, accuracy 0.5%

Temperature range: -20°C a +60°C accuracy 0.5°C

Power supply: 4 x 1.5V AA alkaline batteries

Dimensions: 120 x 120 x 1200 mm

Weight: 1500 g



Determination of liquid limit

Standards UNE 103-103/94 NLT -105/91; ASTM D4318; BS 1377:2; AASHTO T89; NF P94-051

Casagrande method

This method is used to determine the amount of moisture necessary for clay-based terrain to move from the plastic to the solid state.

The test principle is based on the relationship between the moisture content in the soil and the number of impacts required to close a crack made in a soil sample that is 13 mm long (1/2" in ASTM test).

Models:

S0040 Casagrande manual apparatus, supplied with smooth cup, adjustable fall height and standard base.

Dimensions: 140 x 190 x 150 mm

Weight: 2.5 Kg

S0041 Manual Casagrande apparatus supplied with mechanical impact counter, smooth cup, adjustable fall height and standard base.

Dimensions: 140 x 190 x 150 mm

Weight: 3 Kg



Accessories

S0040/1 Casagrande grooving tool in compliance with ASTM D9318 standard

S0040/2 Casagrande grooving tool in compliance with BS 1377 standard

S0040/3 Curved grooving tool in compliance with ASTM standard.

S0040/4 Hovanyi grooving tool in compliance with UNE 103-103/94 standard

V0248 Stainless steel spatula with 120 mm blade

S0044/1 Flat grooving tool in compliance with NF P94-051 standard

S0044/2 Rough cup with smooth middle band 10 mm wide, used for low plasticity soil. NF P94-051

S0042 Motorised Casagrande Apparatus, powered by an electric motor that ensures constant frequency of 120 impacts per minute. Digital display of the number of impacts, memory and test stop button.

Dimensions: 170 x 255 x 255 mm

Weight: 6.6 Kg

S0044 Manual Casagrande cup apparatus supplied with smooth chromec cup, adjustable fall height and bakelite base, in compliance with NF P94-051.



Standards NLT -124; BS 1377; NF P94-052/1
Cone penetrometer method

This method is used to determine the amount of moisture necessary for clay-based terrain to move from the plastic to the solid state. The test is based on the relationship between the amount of moisture and the penetration of a cone in a soil sample, under controlled conditions.

Models:

B0165 Cone penetrometer to determine liquid limit, consisting of a fixed base with adjustable legs, a column with a rapid tip positioning system and reading dial.

Supplied with a 35 mm stainless steel cone point with a 30° angle and a Ø 55 x 35 mm sample container

Weight: 12 Kg

B0166 Automatic cone penetrometer to determine liquid limit, consisting of a fixed base with adjustable legs, a column with a rapid tip positioning system, an electromagnetic device with a timer to control free fall and automatic test point stop.

Supplied with a 35 mm stainless steel conical tip with a 30° angle and Ø 55 x 35, 70 x 45 mm sample containers, and a weight of 20 g.

Weight: 15 Kg

Accessories:

S0043 Conical tip measuring 35 mm long with 30° angle.

S0043/1 Template to check the condition of the 30° angle conical tip.

B0166/5 Brass container, Ø 55 x 35 mm high.

B0166/2 Mirror for easy cone height adjustment.



Determination of plastic limit

Standards UNE103-104/93; NLT -106/72; ASTM D 427; BS 1377; AASHTO T9

S0047 Plastic limit set

Plastic limit is defined as the lowest moisture required for the formation of soil cylinders, with a diameter of approximately 3 mm, that can be rolled without the cylinders breaking apart.

S0047 Plastic limit equipment consisting of the following components:

S0047/1 Glass plates, 300 x 300 mm long.

S0047/2 Metal bar, Ø 3 x 100 mm long.

V8208/4 Porcelain capsule, Ø 100 mm

V024 Flexible spatula with 120 mm long blade

B0166/5 Aluminium containers (6), Ø 55 x 35 mm

S0047/3 Carrying case.



Shrinkage limit

Standards UNE 103108; ASTM D427; BS 1377; AASHTO T92; NF P94-060-1

Shrinkage limit set

S0048 Shrinkage limit equipment consisting of the following components:

S0048/1 Glass plate with three pegs.

V8274/7 Porcelain capsule, Ø 150 mm

V0248 Flexible spatula with 120 mm long blade

S0048/2 Contraction capsule, Ø 42 x 12 mm (2)

S0048/3 Glass crystallizer, Ø 57 x 32 mm

V6742 Graduated 25 ml measuring flask.

S0047/3 Carrying case.



Linear Shrinkage

Standards UNE103-104/93; NLT-106/72; ASTM D4318; BS 1377; AASHTO T90

Mould for determining linear Shrinkage

Plastic limit is defined as the lowest moisture required for the formation of soil cylinders, with a diameter of approximately 3 mm, which can be rolled without the cylinders breaking apart.

S0049 Mould for the manufacture of samples measuring 140 mm long with a radius of 12.5 mm. This test is used to determine linear contraction as well as plastic properties of soil with low clay content.

Weight: 500 g



Determination of specific gravity

Standards BS 1377:2

Cone pycnometer method

This method is used to determine specific gravity and water absorption in sand and fine aggregate

A0562 Glass pycnometer with 1 litre capacity, with brass anti-corrosion lid.



Pycnometer method

V5561 Gay-Lussac 25 mL pycnometer.

V5562 Gay-Lussac 50 mL pycnometer.

V5563 Gay-Lussac 100 mL pycnometer.



Determination of particle density

Standards BS 1377:2

Cylinder method

This method is used in soil containing up to 10% of particles retained by a 37.5 mm mesh sieve

S0056 Flask stirrer for 2 flasks.

Rotation speed: 50 rpm

Accessories

S0056/1 1 litre glass flask with rubber stopper

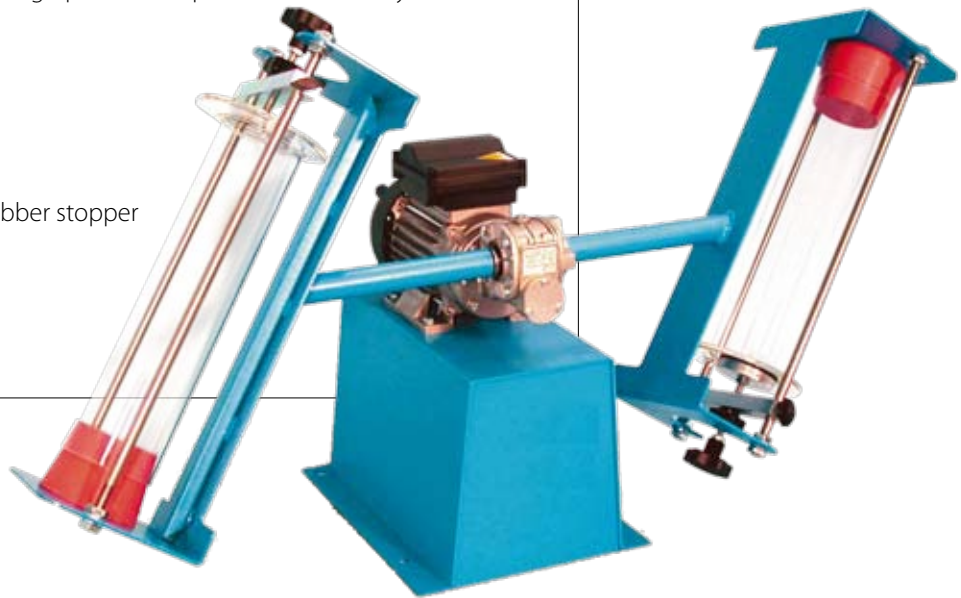

Standards BS 1377, 1924

Water displacement method

This method is used to determine the dry density of soils stabilised by addition of water. One of the following cylinders is used depending on the granulometry of the soil:

S0057 Cylinder, Ø 150 x 250 mm for fine or medium soil granulometry.

Equipped with a siphon located 150 mm from the base.

S0058 Cylinder, Ø 300 x 500 mm for thick soil granulometry.

Equipped with a siphon located 300 mm from the base.

Standards UNE 7045/32

Determination of soil porosity

S0050 Perspex plate with three pegs.

S0051 Glass container, Ø 70 x 15 °

S0052 Glass container, Ø 90 x 50 mm

S0053 Stainless steel pipe and tamper

S0054 Graduated pipe, 25 cm³

Determination of sand equivalent

Standards EN 938-8, UNE 103109; NLT -113/72; ASTM D2419; BS 1924; AASHTO T176; AFNOR P18-598

S0060 Equipment to determine sand equivalent

This test is used to determine clay, lime and dust proportions in granular soil and fine aggregate.

S0060 Complete set of equipment to determine the sand equivalent, consisting of the following components:

S0060/1 Three plastic graduated measuring flasks.

S0060/2 5 L container with siphon lid.

S0060/3 Rod with weighted foot.

S0060/4 Irrigation tube.

S0060/5 85 cm³ measure

S0060/6 Filling funnel.

S0060/7 Mohr clamp.

S0060/8 Rubber tube (1 m)

S0060/9 Three rubber stoppers.



Accessories

S0061 Miniature sample divider

S0062 5 litre solution bottle.

S0063 Mechanical stirrer powered by an electric motor. Equipped with a timer that stops the device automatically at the end of the stirring cycle.

V0070 Digital stop clock

V0162/2 Stainless steel graduated ruler. Length 500 mm

A1147 Sieve, Ø 200 mm, mesh size 2 mm

Stroke: 20 cm

Frequency: 90 cycles every 30 seconds.

Power supply: 380 V / 50 Hz, three phase

Dimensions: 500 x 600 x 320 mm

Weight: 35 Kg



Particle size distribution

Standards BS 1377

Pipette sedimentation method

The purpose of this test is to determine the quantitative distribution of particles in the soil.

The equipment consists of:

S0065 Vessel, 600 x 300 x 380 mm made of transparent material.

S0066 Thermostat unit with digital temperature control and stirrer.

Temperature range: 10 - 100° C.

V0070 Andreasen glass pipette. Capacity 25 mL

S0068 Adjustable pipette stand with portable cart.

Dimensions: 210 x 510 x 900 mm

S0069 Sedimentation flask with rubber stopper.

Capacity: 500 mL

Accessories

V0067 Andreasen glass pipette. Capacity 10 mL

S0071 Sodium hexametaphosphate, 1 Kg package



Standards UNE 103102; ASTM D422; AASHTO T88; BS 1377

Densitometer sedimentation method

The purpose of this test is to determine the granular composition of sieved soils by measuring the density of soils in suspension.

The complete unit consists of:

S0065 Vessel, 600 x 300 x 380 mm made of transparent material.

S0066 Thermostat unit with digital temperature control and stirrer.

Temperature range: 10 - 100° C.

S0075 Densitometer, 0.980 - 1038 g/litre.

S0076 Bouyoucos densitometer, 0 - 60 g/litre.

V6747 Graduated flask, 1000 cc. The unit is supplied with six.

V6804 250 mL flask

S0071 Sodium hexametaphosphate, 1 Kg package

V0918 Graduated laboratory thermometer, 0-50°C

V0070 Stop clock.

S0081 High speed stirrer with a motor capable of reaching 12000 rpm. The motor is attached to the base by a rigid column. The sample is spread by a stainless steel helix placed over the motor shaft. Supplied with a 0.8-litre stainless steel container.

Power supply: 220 V 50 Hz 200 W, single phase

Dimensions: 200 x 503 mm high.

Weight: 5.2 Kg



S0072 Hand-operated stirrer for 2000 mL flasks (NF P94-057)



Chemical soil analysis

Standards BS 1377

Fundamental parameters, such as the following can be determined by performing certain chemical tests: organic material, sulphate content, pH, alkalinity, etc. The purpose of these tests is to obtain an initial classification of the soil samples to be tested

Determination of the sulphate content by the ion exchange method

S0085 Ion exchange apparatus to determine the sulphate content in aqueous soil samples. The device consists of a \varnothing 10 x 400 mm long ion exchange column and a constant load device, all installed on a metal stand.

Dimensions: 190 x 110 x 600 mm

Weight: 3 Kg

Accessories:

S0085/1 Ion exchange resin, 500 g

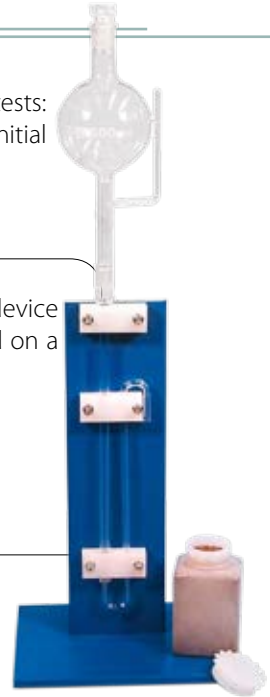

Determination of pH

The pH is defined as the negative logarithmic representation of hydrogen ion concentration (H⁺) in a solution. The test can be performed by two different methods:

Electrometric method, (pH-meter).

Colour index method, (reagents and colour charts).



Standards UNE 77305; BS 1377; ASTM D1067

Electrometric method

S0086 Portable combination pH-meter to measure pH, mV and °C both in the laboratory and "in situ".

Measurement range: 0 - 14 pH / 0 - 1999 mV / 0 - 100 °C

Supplied with a plastic housing, pH electrode gel, temperature probe, pH 4 and 7 buffer solution and carrying case.

Dimensions: 185 x 82 x 45 mm

Weight: 280 g



S0087 Laboratory pH-meter with microprocessor to determine pH, mV and selective ions in the laboratory. Wide range, simultaneous LCD pH/mV and temperature display with graphic symbols that guide the user through the calibration process. Automatic calibration in 1 or 2 points with 5 memorised standard values.

Measurement range: 0 - 14 pH / \pm 399.9 - 1999 mV / 0 - 100 °C

Supplied with a glass body electrode, combination pH electrode, stainless steel temperature probe, electrode stand, pH 4 and 7 buffer solution, electrolyte, cover and carrying case.

Dimensions: 230 x 170 x 70 mm

Weight: 1.3 Kg



Determination of pH
Standards BS 1377; ASTM D1067
Colorimetric method (reagents)

This method uses chemical indicators to prepare field samples and determine pH by colour comparison.

S0090 BDH equipment for chemical soil tests

The equipment is supplied in a carrying case and consists of the following components:

- Barium sulphate (100 g)
- Soil indicator (100 mL)
- Distilled water bottle (500 mL)
- Stainless steel 120 mm spatula.
- Measuring flask with rubber stopper (12)
- Tube cleaning brush.
- Colour chart, 4.0 to 8.0 pH range divided in 0.5 pH

Colorimetric method (colour chart)

Colour identification is an essential component for the description of soil profiles. Proeti has two sets of colour charts available for colour identification by comparison, to assist specialists in the identification of soil samples.

S0093 Soil colour charts, each set consists of 7 constant tone charts over a neutral grey background.

S0094 Tropical soil colour charts, a set of 2 charts for use with red tropical soils, recommended for regions such as South America, Central America, Africa, Malaysia, India and similar tropical regions.

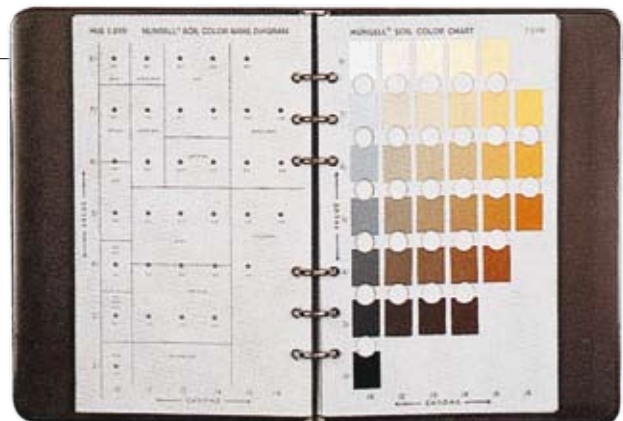
Standards UNE 103-204-93

Determination of oxidisable organic material content in soil. Potassium permanganate method.

Standards NLT -117/72

Organic material content in soil, oxygenated water method.

Standards NLT -118/72

Organic material recognition in soil. Potassium dichromate method.

These tests require standard laboratory material, included in the relevant section of this catalogue.

Alkalinity, chlorides and water hardness

S0096 Equipment to determine the alkaline content in chlorides and water hardness.

Total alkalinity is measured in CaCO_3 . Chloride is determined by using a reactive mixture of silver nitrate and potassium chromate. Water hardness is determined with EDTA reagent.

Dimensions: 250 x 150 x 150 mm

Stirrers

S0098 Sulphate stirrer

S0098 Sulphate stirrer, capacity of 12 1-litre jars. The jar fastening system adapts to jars of various sizes and capacities.

Rotation speed: 50 rpm

Power supply: 380 V 50 Hz

Dimensions: 750 x 700 x 600 mm

Weight: 25 Kg

Accessories

S0098/1 1-litre glass flask.

S0098/2 Protection system.

S0100 Orbital stirrer with a 400 x 300 mm tray, equipped with four padded attachment shafts for a variety of applications. Stirring speed is adjustable between 40 and 400 rpm

Includes digital rpm counter and timer clock which can time periods from 0 to 60 minutes.

Capacity up to 20 Kg

Eccentricity: 19 mm

Dimensions: 200 x 410 x 310 mm

Weight: 12 Kg



V0135 Magnetic heated stirrer

V0135 Magnetic heated stirrer with contact thermometer connection device. Temperatures adjustable up to 350°C. Circular stainless steel Ø 150 mm plate. Electronic adjustment that allows optional attachment of a contact thermometer or digital programmer.

Speed: 30 to 1800 rpm

Stirring capacity: more than 10 litres.

V0136 Unheated magnetic stirrer

Accessories

V0130/1 Support rod, Ø 12 x 450 mm



Soil consolidation

Standards UNE 103-405; ASTM D2435, D4546; BS 1377:5; AASHTO T216; NF P94090-1, P94-091

The purpose of this test is to establish a method to measure single dimension consolidation of soil, the pore pressure ratio and consolidation coefficient at successively increasing pressures; the sample is constrained laterally and subjected to an axial load, allowing drainage from the top and the bottom.

Consolidation cells

S0105 Centre-loading oedometer made of sturdy cast aluminium to minimise frame distortion. Equipped with a lever loading system with three ratio positions (9:1, 10:1, 11:1), mounted on ball bearings with an adjustable counterweight, a load locking device and a stand with a dial gauge measuring 10 x 0.01 mm

Maximum axial load: 17500 N (lever 11:1)

Dimensions: 480 x 200 x 820 mm

Weight: 32 Kg

Accessories for oedometer

V0016 Dial gauge with 10 x 0.01 mm precision.

S0107 Single operator work bench.

S0108 Three operator work bench.

Sets of weights

Made of galvanised steel, with a groove to place the weights on the oedometer lever.

Reference	SET OF WEIGHTS / WEIGHTS
S0109	50 Kg (3 x 10 Kg - 2 x 5 Kg - 3 x 2 Kg - 2 x 1 Kg - 3 x 0.5 Kg - 2 x 0.2 Kg - 1 x 0.1 Kg)
S0109/1	10 Kg
S0109/2	5 Kg
S0109/3	2 Kg
S0109/4	1 Kg
S0109/5	0.5 Kg
S0109/6	0.2 Kg
S0109/7	0,1 Kg



Consolidation cells

The consolidation cells are made of stainless steel and supplied in two different versions:

Standard consolidation cell

Consolidation cell with permeability testing device

Supplied with stand, plexiglass cylinder, 2 porous stones, loading piston and cutting ring.



Specimen area	20 cm ²	40 cm ²	50 cm ²	100 cm ²
Sample dimensions	50.5 x 20 mm	71.4 x 20 mm	79.8 x 20 mm	112.8 x 20 mm
Standard cell	S0110	S0111	S0112	S0113
Permeabilit		S0115	S0116	S0117
Porous stone	S0110/1	S0111/1	S0112/1	S0 113/1
Cutting ring	S0110/2	S0111/2	S0112/2	S0 113/2
Standard cell disc	S0110/3	S0111/3	S0112/3	S0 113/3
Permeability cell disc	S0110/4	S0111/4	S0112/4	S0 113/4

S0232 Software for oedometric tests

This computer application is part of the soil testing package that includes the Oedometer, Direct shear, Simple compression, CBR tests and Triaxial test software.

The software is always divided into two applications.

DATA COLLECTION/DATA ANALYSIS.

The **DATA COLLECTION** application is common to all tests. This application includes highly intuitive menus that allow the user to choose predefined tests and to create new tests with new control parameters that are particularly useful for research centres. The sensors are also managed with this application, which enables them to be registered, deregistered, calibrated, etc.

The software can be used to control a large number of tests simultaneously and allow them to be viewed in real time. It also has data backup capability in the event of power outage.

The **DATA ANALYSIS** application is used to study the results of oedometric tests and includes the following tests:

- Standard oedometer (EDO)
- Free swelling (HIL)
- Swelling pressure (PHI)

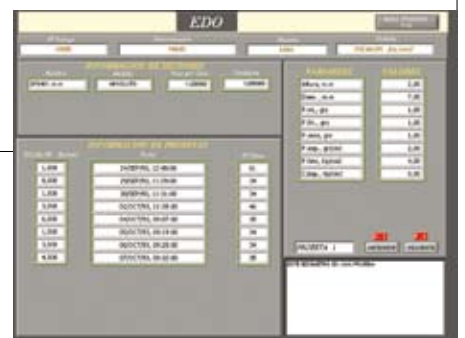
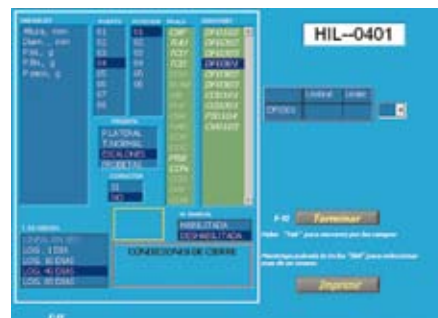
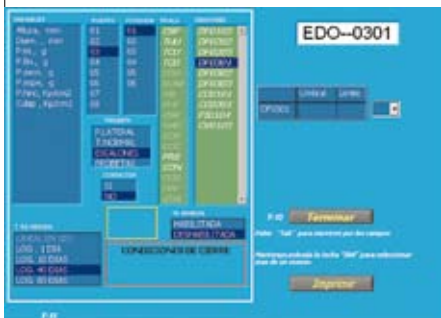

Accessories needed to computerise the consolidation equipment

- S0231 Data collection application
- S0232 Oedometric test application package.
- S0105PC PC
- S0200/1 Data acquisition card with 16 channels
- S0380/0 Signal converter
- S0200 Data acquisition unit with 16 channels
- S0237/0 LVDT, 8 mm
- S0238/5 LVDT-Unit connection cable S0200
- S0238/4 6 m extension cable



Soils Volume Change

Standards UNE 103600

The purpose of this test is to quickly identify soils which may present problems through volume change as a result of variations in moisture content.

S0120 Lambe apparatus

This apparatus consists of a sturdy two-column structure with a stand and top cross-head for attachment of a dynamometric ring with a millesimal dial gauge. Complete with cell and porous stones.

Load capacity of ring: 2 kN (5 x 0.001 mm dial gauge)

Dimensions: 560 x 300 x 300 mm

Weight: 25 Kg

Accessories

S0121 Compaction hammer, 2.5 Kg.

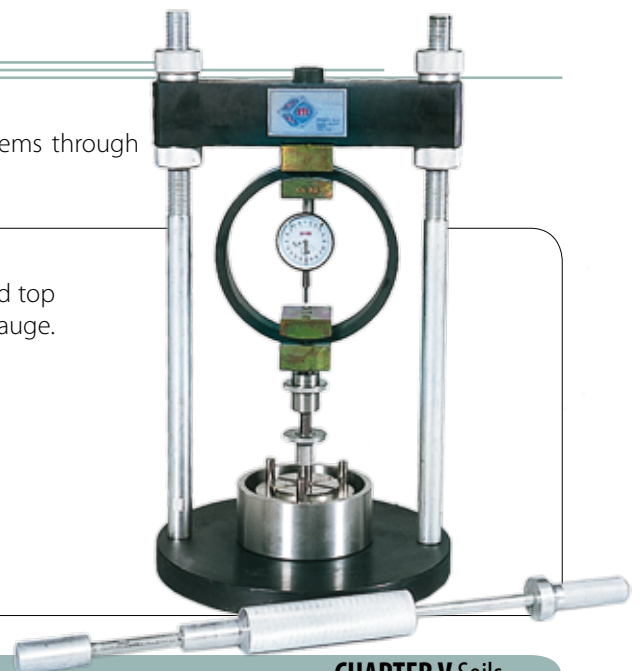

Direct shear test and Vane test

Standards UNE 103401; ASTM D3080; BS 1377

This test is used to determine the shear strength of consolidated specimens with or without drainage. This test can be performed on any type of soil and with unaltered or remoulded samples.

S0125 Direct/residual shear apparatus

This shear apparatus can be used to test square specimens measuring 60 x 60 or 100 x 100 mm and cylinder specimens measuring \varnothing 60 x 20 mm. Shear force is applied by a motor with infinitely adjustable test speed, a completely digital control system and LCD screen. The vertical load is applied directly on the sample by an amplification lever with a ratio of 10:1. The motor can easily be inverted for residual shear testing. The tray containing the two shear blades is made of non-ferrous material and mounted on two rails fitted with ball bearings.

Test parameters are entered via a keyboard and alphanumeric display that allows fast, infinite changes in settings. The device includes an RS 232 output for connection to a PC.

Principal characteristics of the shear apparatus

Shear velocity adjustable between 0.00001 and 6 mm/min

Maximum shear force: 5000 N

Vertical load ratio: 10:1

Maximum vertical load: 500 N

Maximum vertical load using the lever: 5500 N

Shear box and accessories made of brass.

Power supply: 220-240 V 50 Hz, single phase

Dimensions: 1100 x 1200 x 550 mm

Weight: 150 Kg

The apparatus is supplied with a 5 kN dynamometric ring, lever with load ratio of 10:1, set of 50 Kg weights and two 10 x 0.01 mm dial gauges.

Accessories and Spare parts

S0126 Set of 50 Kg weights made of painted steel:
(4 x 10 Kg; 1 x 5 Kg; 2 x 2 Kg; 1 x 1 Kg)

S0127 Shear box for cylinder specimens measuring \varnothing 60 x 20 mm

S0127/1 Porous stones, \varnothing 60 mm

S0127/2 Cutting ring, \varnothing 60 mm

S0128 Shear box for cubic specimens measuring \varnothing 60 x 60 mm

S0128/1 Square porous stones, 60 x 60 mm

S0128/2 Shear accessories, 60 x 60 mm

S0129 Shear box for cubic specimens measuring 100 x 100 mm

S0129/1 Square porous stones, 100 x 100 mm

S0129/2 Shear accessories, 100 x 100 mm

Spare weights:

S0126/1 Calibrated weight, 10 Kg

S0126/2 Calibrated weight, 5 Kg

S0126/3 Calibrated weight, 2 Kg

S0126/4 Calibrated weight, 1 Kg

S0126/5 Calibrated weight, 0.5 Kg

S0126/6 Calibrated weight, 0.250 Kg

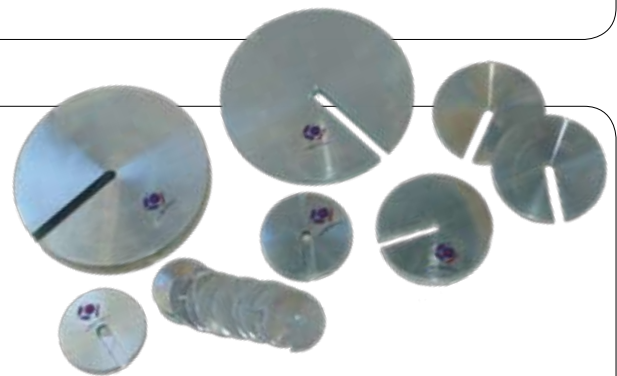

Principal characteristics of the shear apparatus

Accessories and Spare parts (continued)

- V0004 5 kN dynamometric ring
- V0014 Dial gauge, 10 x 0.001 mm
- V0016 Dial gauge, 10 x 0.01 mm
- V0017 Dial gauge, 30 x 0.01 mm
- V0024 Digital dial gauge, 12 x 0.001 mm

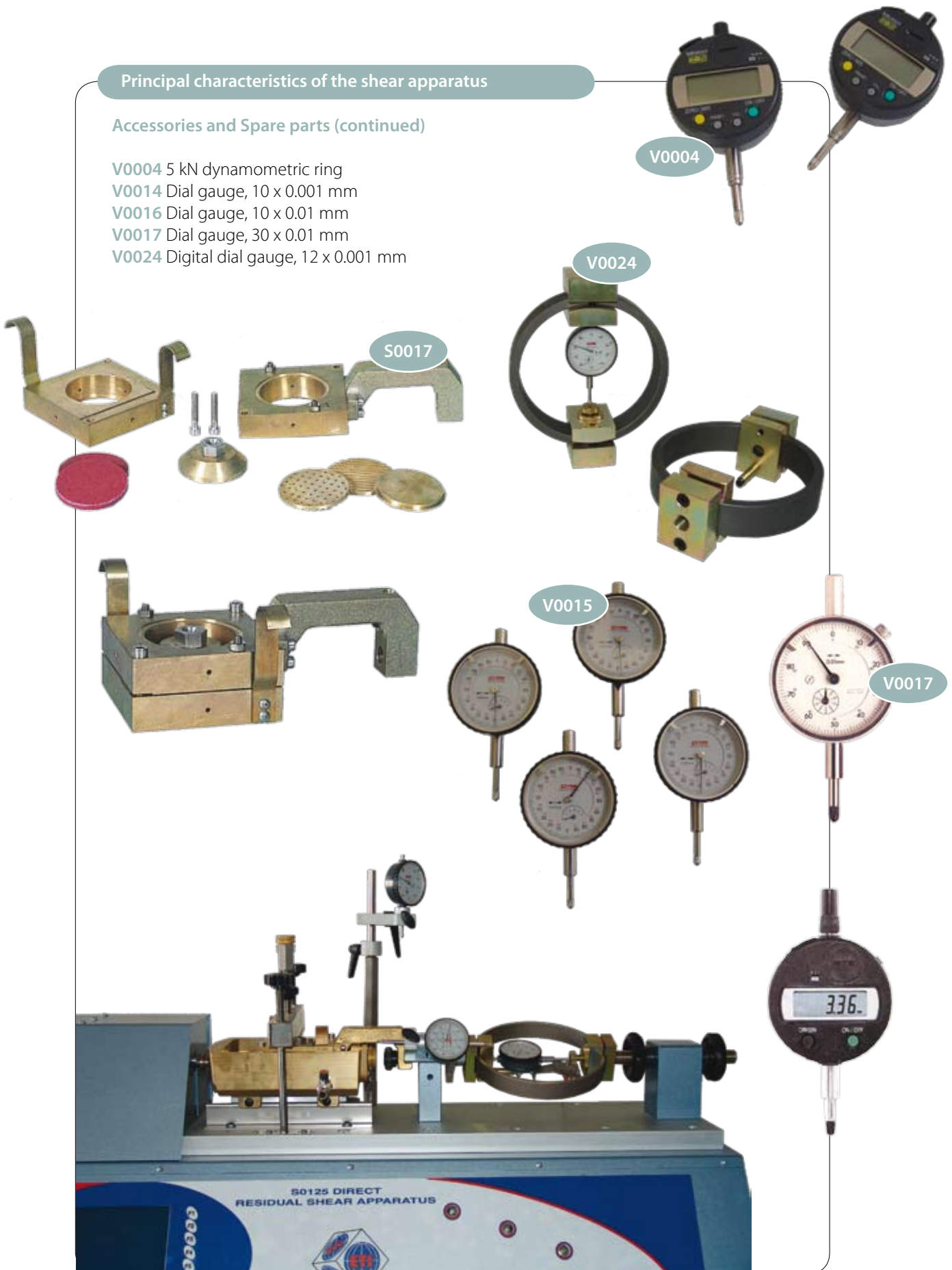

S0233 Software for direct shear tests

This computer application is part of the soil testing package that includes the Oedometer, Direct shear, Simple compression, CBR tests and Triaxial test software. The software is always divided into two applications.

DATA COLLECTION
DATA ANALYSIS.

The **DATA COLLECTION** application is common to all tests. This application includes highly intuitive menus that allow the user to choose predefined tests and to create new tests with new control parameters that are particularly useful for research centres. The sensors are also managed with this application, which enables them to be registered, deregistered, calibrated, etc.

The software can be used to control a large number of tests simultaneously and allow them to be viewed in real time. It also has data backup capability in the event of power outage.

The **DATA ANALYSIS** application is used to study the results of direct shear tests and includes the following tests:

- Rectangular direct shear (COR)
- Circular direct shear (COC)
- Velocity determination test (VEL)

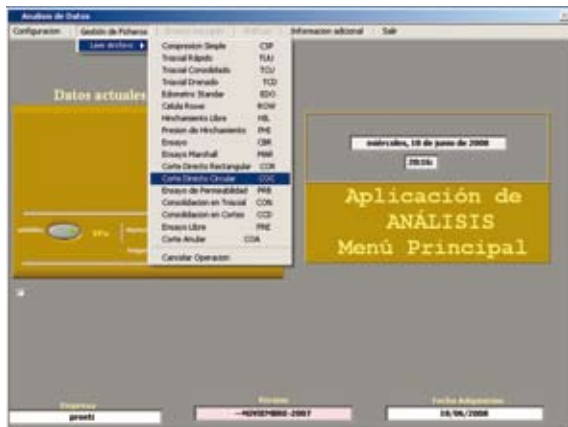
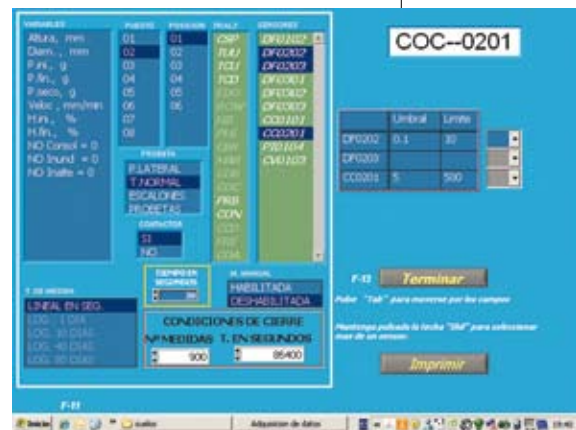

Accessories needed to computerise the direct shear equipment

- S0231 Data acquisition application
- S0233 Software for direct shear tests
- S0105PC PC
- S0200/1 Data acquisition card with 16 channels
- S0238/0 Signal converter
- S0200 Data acquisition unit with 16 channels
- S0237/0 LVDT, 8 mm
- S0237/1 LVDT, 25 mm
- V0029/3 5 kN load cell
- S0238/5 LVDT-Unit connection cable S0200
- S0238/4 6 m extension cable

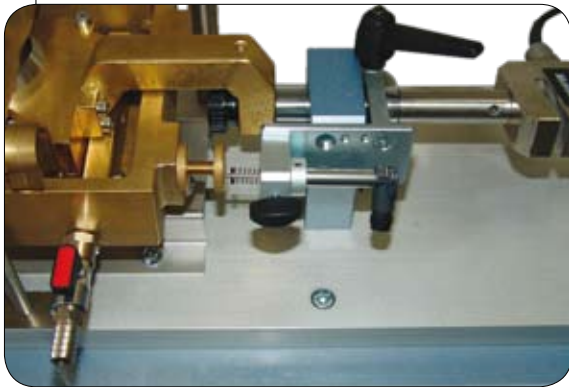

Computerised direct shear equipment



S0133 Hand-operated direct/residual shear

This apparatus has similar characteristics to the model described above. The shear force is applied manually by means of a load screw. This manual model is ideal for teaching centres.

The apparatus is supplied with a 300 kN dynamometric ring, lever with load ratio of 10:1, set of 50 Kg weights and two 10 x 0.01 mm dial gauges.

The accessories and spare parts for this equipment are the same as those of the model above.

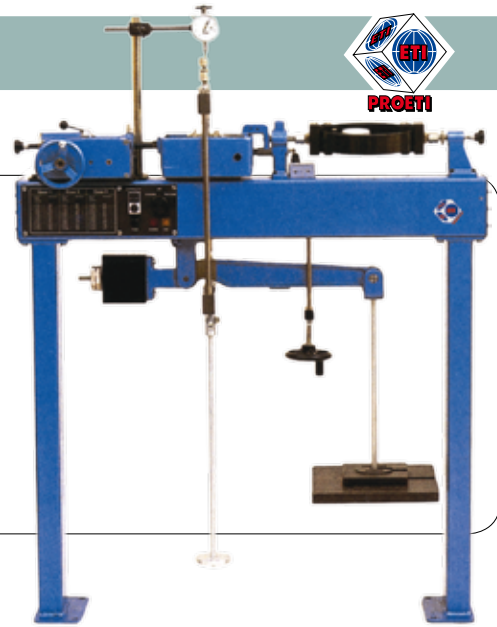

Standards UNE 103401; 103405

S0137 Consolidation workbench

Designed to apply a constant load to samples contained in a shear box and so reduce testing time when there is more than one sample and only one shear device. Also adapted to consolidate specimens contained in oedometric cells. The workbench is formed of a steel structure with centring plates for the shear boxes and oedometric cells. A lever system is used to apply loads by placement of weights. The equipment can be used to perform 3 simultaneous tests. Supplied with three centesimal dial gauges and three levers with ratio of 10:1 and loads of up to 550 Kg. The weights, water containers and cells must be ordered separately.

Dimensions: 1800 x 500 x 1200 mm

Weight: 100 Kg approx.

Accessories:

S0138 Water container made of plexiglass and aluminium. Allows the shear box to be prepared during the consolidation test while keeping the samples under water.

S0126 Set of weights, 50 Kg.



Standards BS 1377

Vane test

S0140 Vane apparatus for the laboratory

Designed to determine the shear strength of confined soil samples, contained in a sample tube with a maximum \varnothing 82 mm. The apparatus consists of a stand on which are fixed two columns that hold the torque device and a handle for vertical adjustment. The torque meter is powered by a gearbox with a clutch that rotates 10° every 30 seconds.

The equipment is supplied with a cross-shaped paddle measuring 12.7 x 12.7 mm and four calibrated springs for the following torques: 1 - 15 - 2 and 2.5 Kg/cm²

Spare parts

S0140/1 Set of four springs

S0140/2 Paddle, 12.7 x 12.7 mm



Triaxials Proetti

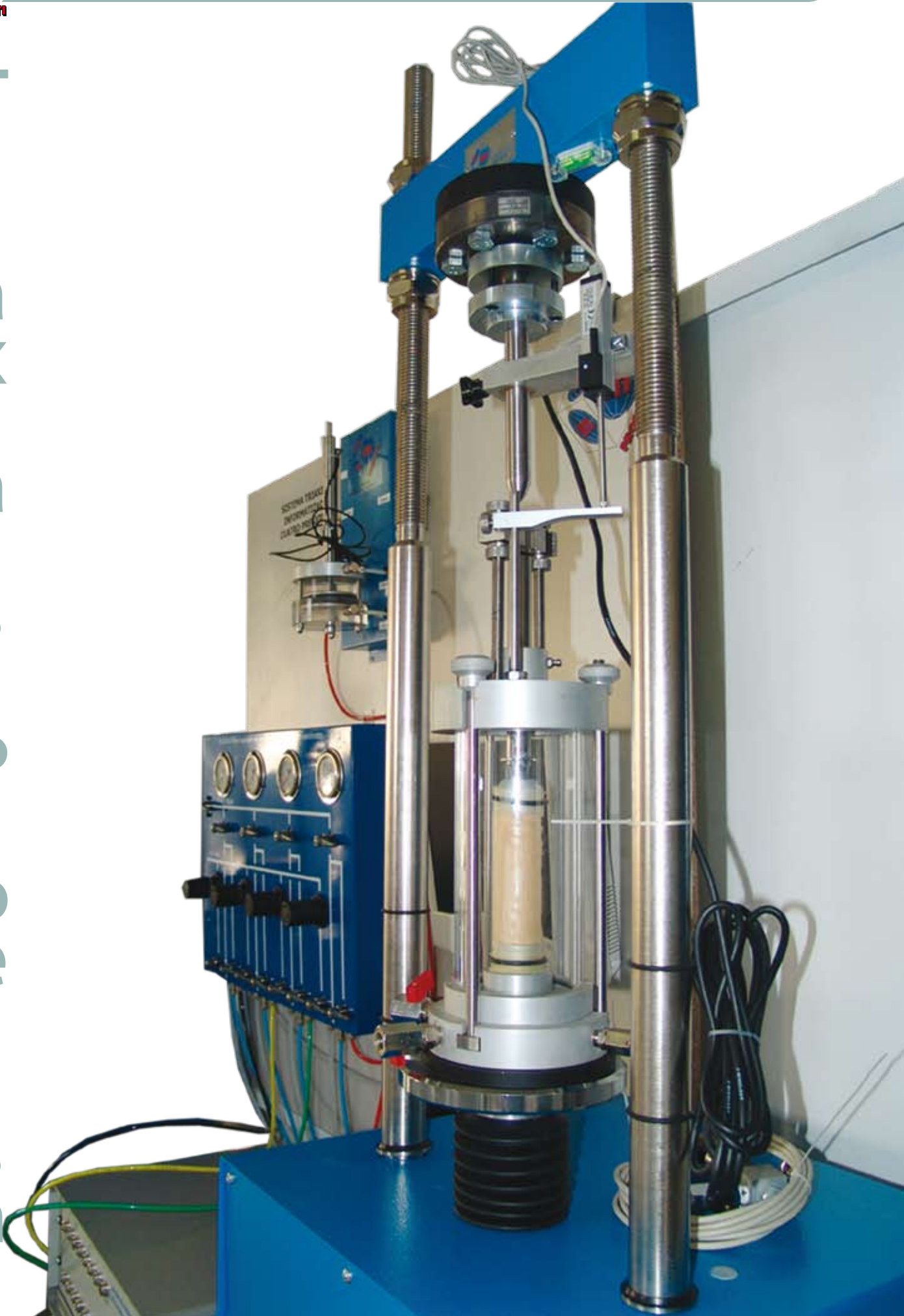

Triaxial test

The application of local loads or pressure on soil determines its deformation, settling and yield.

The Triaxial test is normally performed to determine the relationship between these loads and the subsequent deformation, in order to determine soil shear strength.

The experimental research used to determine the strength-force ratio is normally performed by a triaxial compression test.

During the test, the unaltered soil samples are gradually deformed until they break, corresponding to the maximum shear force.

The test is performed by placing the cylinder soil sample in a rubber membrane and subjecting it to isotropic hydraulic pressure.

Afterwards, an axial load is applied to the specimen by means of a piston so that the soil sample is deformed at a constant speed.

The Triaxial test can be performed using the following methods:

- Non-consolidated, undrained test.
- Consolidated, undrained test.
- Consolidated, drained test.

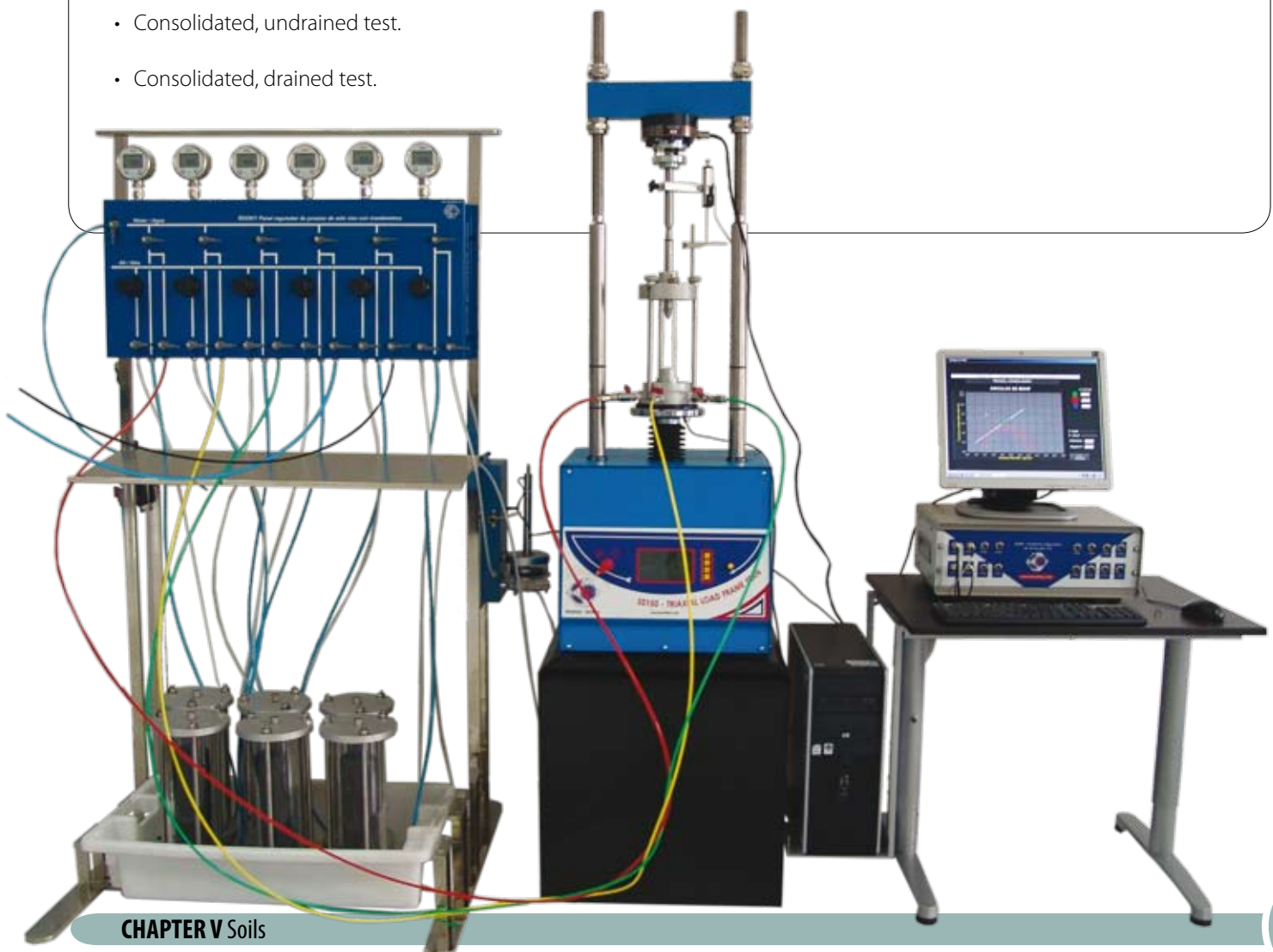

Quick undrained (QU) and Unconsolidated Undrained (UU)

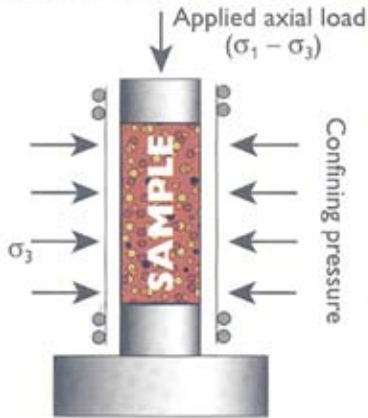

UU - Non-consolidated, undrained test

This determines the shear strength in undrained conditions, i.e., without affecting the specimen structure or modifying the status of the existing geostatic tensions.

After having applied pressure to the cell, the specimen volume cannot be altered and the immediate next step is the failure stage. This test measures both the load and the interstitial pressure.

This method is used to study the essential characteristics of soil foundations.

CU - Consolidated, undrained test

This test method varies slightly from the "UU" method in that it allows the volume of the specimen to be altered until the consolidation pressure is stabilised.

Volume variation is locked during application of the axial load and both the load and the interstitial pressure are measured. The "CU" method is used to stabilise the strength characteristics of foundations over time, as well as to verify improvements due to preconsolidation, compaction and stabilisation.

Consolidated Undrained (CU)

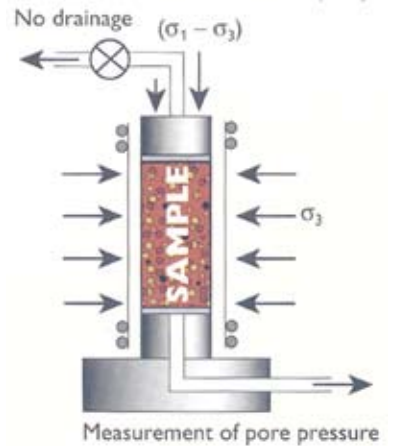

Consolidated Drained (CD)

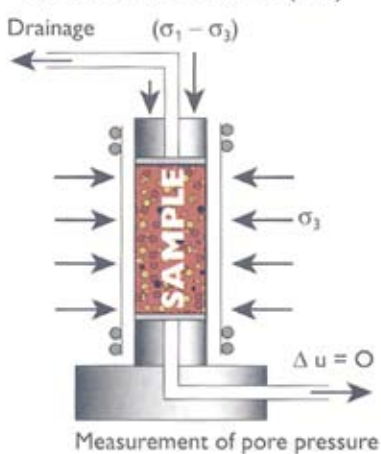

CD - Consolidated, drained test.

The consolidated, drained test requires slow execution to prevent an increase in interstitial pressure inside the specimen when the axial load is applied.

This method is generally used in very permeable terrains because it is the method best suited to reproducing geotechnical problems and controlling terrain characteristics.

Triaxial press

This machine not only performs different types of triaxial tests, but by incorporating the appropriate accessories, it can be used to perform CBR and ELL tests as well.

S0150 Digital triaxial machine with a microprocessor with 50 kN capacity

The machine consists of a sturdy test frame with two columns and an upper cross-head that can be adjusted by threaded bolts.

Equipped with a swivel joint and fitted with a motor with an electronically powered ball screw for infinite variation of the test speed.

Includes a safety end-stop that halts motion of the bottom plate. Complete with protective cover, control panel with main switch and speed selection display.

Technical characteristics:

Maximum capacity: 50 kN

Adjustable speed: from 0.00001 to 6 mm/min

Upper cross-head adjustment: up to 460 mm

Maximum vertical span: 790 mm

Horizontal span: 305 mm

Bottom plate diameter: Ø 177 mm

Power supply: 220-240 V 50 Hz, single phase

Weight: 105 Kg

The press is supplied without the load cell, which must be ordered separately. The available cells or transducers are the following:

V0028 50 kN force transducer.

V0029 20 kN force transducer.

V0029/1 10 kN force transducer.

V0029/2 5 kN force transducer.

V0029/3 50 kN submersible force transducer.

Accessories for the triaxial press

S0150/1 Load piston. This is attached to the force transducer or to the ring mounted on the machine. Has a round tip that makes it suitable for use with the cell.

S0150/2 Press platen adapter / triaxial cell. Placed between the triaxial cell and the press platen. This allows the loads to be transmitted axially.



Linear displacement transducers

S0238 Linear displacement transducer, 25 mm
Mechanical attachment.
Stroke: 25 mm
Independent linearity up to 0.05%.
Infinite resolution.
Electrical connections: 1.50 m of 3-pole shielded wire.

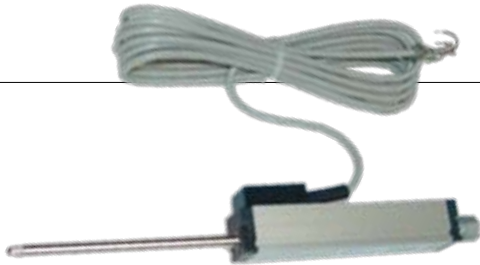

S0239 Linear displacement transducer, 50 mm
Mechanical attachment.
Stroke: 50 mm
Independent linearity up to 0.05%.
Infinite resolution.
Electrical connections: 1.50 m of 3-pole shielded wire.
S0239/1 Stand for the linear displacement transducer.



Pressure transducers

S0175 Pressure transducer, 0-10 bar
Sensor class: 0.5.
Linearity: 0.2%.
Repeatability: 0.1% fs
Power supply: 10 V

S0176 Pressure transducer, 0-20 bar
Sensor class: 0.5.
Linearity: 0.2%.
Repeatability: 0.1% fs
Power supply: 10 V



Force transducers

V0028 50 kN force transducer.
Class: 0.5
V0029 20 kN force transducer.
Class: 0.5
V0029/1 10 kN force transducer.
Class: 0,5
V0029/2 5 kN force transducer.
Class: 0.5
V0029/3 50 kN submersible force transducer.

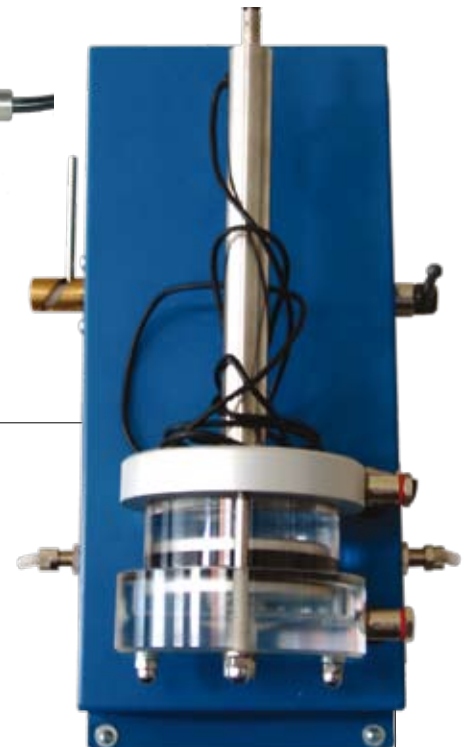

Volume change transducers

S0240 Automatic volume variation measurement system. Connected to unit **S0200**, provides an electric signal directly proportional to the volume of water flow through the instrument. The apparatus is formed by a piston connected to a linear transducer and sealed to a cylinder manufactured to extreme tolerances, such that the linear movement of the piston is proportional to the water volume inside the cylinder. There are two working positions. In one of the positions, the equipment is not operational, so the water flows through without acting on the transducer. In the other position, the equipment measures the water volume flowing through the transducer. Readings are taken in absolute values, so setting to zero is not necessary. The test mode can also be started in any of the piston positions.

Water volume: 114 cm³
Transducer power supply: 10 V
Dimensions: 100 x 270 x 135 mm
Weight: 3 Kg

Triaxial cells with five ports

Reference	S0151	S0152	S0153
Maximum specimen dimensions (day x h)	50 x 100 mm	70 x 140 mm	100 x 200 mm
Maximum operating pressure	1700 Kpa	1700 Kpa	1700 Kpa
Maximum axial load	45 kN	45 kN	45 kN
Vertical height required	380 mm	440 mm	515 mm
Horizontal distance required	155 mm	180 mm	210 mm
Weight	3.5 Kg	7.5 Kg	14 Kg



Triaxial cells with five ports

The triaxial cells are designed to meet the requirements of a modern soil laboratory. Three quick-release attachment rods are used to hold the cylinder and head unit to the base. The high quality finish between the piston and the head, the use of a circular sealing ring and a special lubricant reduce friction levels and prevent water leaks.

All the cells are made of aluminium, with five basic openings; two for top rear drainage/pressure, two for bottom drainage/pore pressure and one for confinement pressure.

The standard equipment is supplied with four non-volumetric switch valves equipped with quick connect systems.

Accessories for triaxial cells

The triaxial cells have been designed for high flexibility when used with samples of varying dimensions. This is why accessories must be ordered separately. (Refer to the table).

The cells can be used to test samples of different sizes by simply replacing the base adapters.

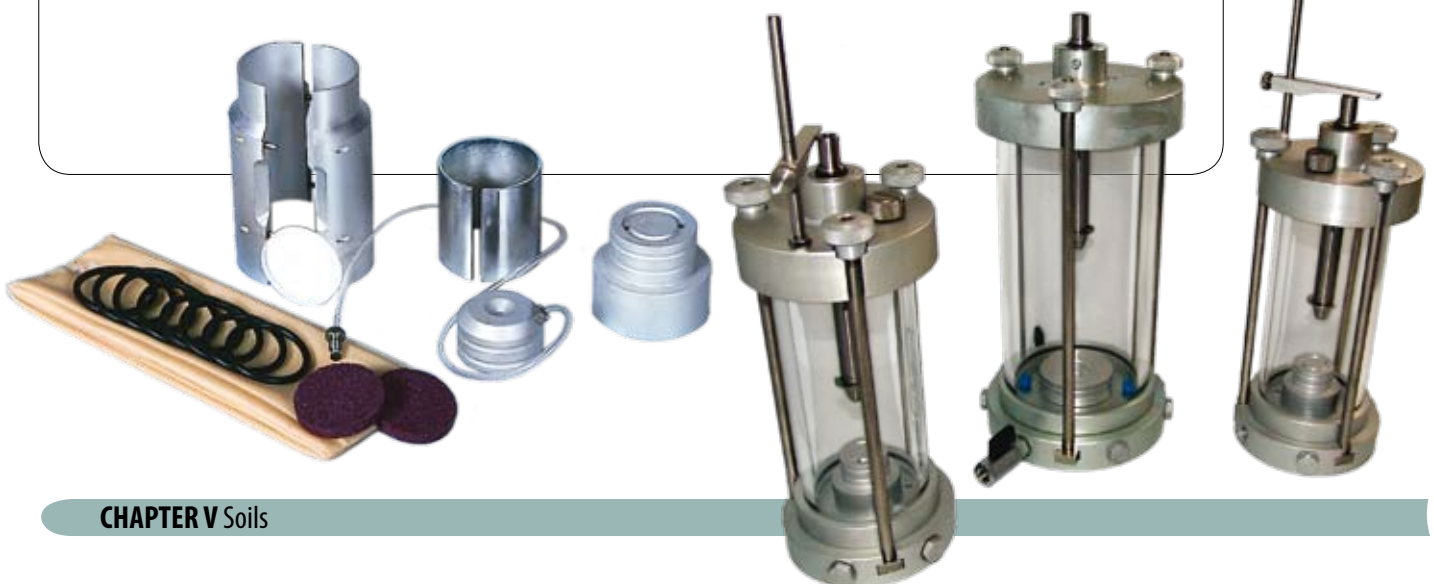



Base adapter

Made of anodised aluminium. Used to adapt the cell to specimen dimensions. Complete with holes for draining and interstitial pressure measurement.

Top head with drainage

Made of anodised aluminium. Used to compress the specimen from the top. Complete with tube and connection coupling to the base of the specimen. The head can be used for drain and non-drain testing.



Top head without drainage

Made of anodised aluminium. Used to compress the specimen from the top. The head cannot be used for drain testing.

Porous disc

Made of quartz aggregate. Placed in direct contact with the specimen. Used in drained tests (2 units are required).

Thickness: 10 mm

Mean porosity: 0.020 mm



Non-porous disc

Made of plexiglass. Placed in direct contact with the specimen. Used in undrained tests (2 units are required).

Thickness: 10 mm



Rubber membrane

Made of high quality latex. Placed directly on the specimen to isolate it from lateral pressure. Supplied in bags of 10.



Sealing rings

High quality ring-type accessory. Placed on the membrane to seal the specimen. Supplied in bags of 10.



Membrane holder

Used to facilitate mounting of the rubber membrane and sealing rings.



Filter paper

Used to improve specimen drainage on the lateral sides in drain tests and for low-permeability specimens (clays).
Supplied in boxes of 50.



"O" ring assembly tool

Used to facilitate assembly of the ring on the membrane.



Split mould

Made of aluminium. Used to prepare non-cohesive specimens (sand) together with the triaxial cell and the membrane. It is divided in two halves with a sealing ring



Three part mould

Made of stainless steel. Used to prepare and compact non-cohesive specimens. Divided in three parts for easy demoulding.



S0151/40 Sample cradle, 38.1 mm

Made of stainless steel. Used to cut samples.



Compaction hammer

Used to compact samples of non-cohesive materials.

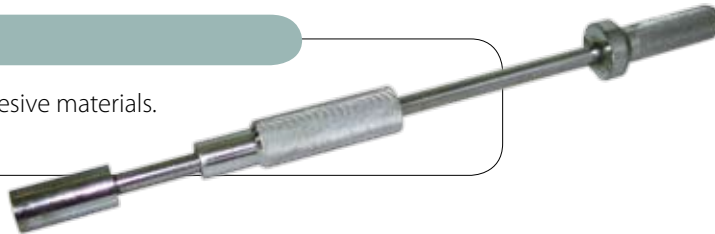

S0151/20 No change indicator

This is mounted directly on the triaxial cell. It comes with a threaded coupling, spanner and quick connectors. Made from a single aluminium block, it eliminates the need for connecting tubes to the cell, so avoiding variations in volume.

Weight: 200 g

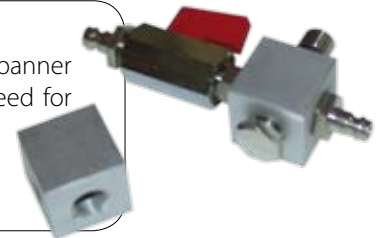

S0151/20/P No change indicator with pressure sensor

This is mounted directly on the triaxial cell. It comes with a threaded coupling, spanner and quick connectors. Made from a single aluminium block, it eliminates the need for connecting tubes to the cell, so avoiding variations in volume.

Weight: 200 g



S0151/8 Piston braking device

Made of stainless steel. This holds the piston so the sample does not move sideways during saturation.

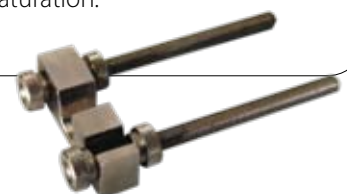



S0151/21 Drainage kit

Consisting of two quick connectors, one for the triaxial cell stand and the other for the top drain head, as well as a connecting pipe.



S0151/39 Sampling cutting device (38.1mm)

Consisting of a stainless steel pipe with a cutting edge and a wooden wedge used to extract the sample.



S0166 Panel stand

Calibrated platen stands have been made to hold the panels. These are equipped with a working tray used for small tools, paper for notes, etc.

The stands are finished by polishing then chroming.

Dimensions: 1900 x 1020 x 900 mm

Weight: 40.5 Kg

The stand has drill holes at various heights so that the working panel can be set at the height required by the laboratory worker.

The unit has two sturdy stands that do not impede movement or relocation because they do not require fastening to the floor or walls. The base has a holder for the plastic tray used for the air / water cells.



S0167 Air /Water cell tray

Each six-pressure station is mounted on a panel stand. Each panel stand has a tray at the base to house the air / water cells.

The tray houses the air / water cells and collects the water that leaks during bleeding and/or maintenance operations.

Technical characteristics

Capacity: 30 litres.

Dimensions: 805 x 450 x 152 mm

Sample diameter	Ø 38.1	Ø 150	Ø 50	Ø 70	Ø 100
Base adapter	S0151/30	S0151/10	S0151/50	S0152/10	S0153/10
Top head without drainage	S0151/31	S0151/11	S0151/51	S0152/11	S0153/11
Porous disc (2 units)	S0151/32	S0151/12	S0151/52	S0152/12	S0153/12
Rubber membrane (10 units)	S0151/33	S0151/13	S0151/53	S0152/13	S0153/13
Sealing rings (10 units)	S0151/34	S0151/14	S0151/54	S0152/14	S0153/14
Membrane holder	S0151/35	S0151/15	S0151/55	S0152/15	S0153/15
Filter paper (50 units)	S0151/36	S0151/16	S0151/56	S0152/16	S0153/16
Split mould	S0151/37	S0151/17	S0151/57	S0152/17	S0153/17
"O" ring tool	S0151/38	S0151/18	S0151/58	S0152/18	S0153/18
Cutting sampling device + Wooden wedge	S0151/39	S0151/19	S0151/59	S0152/19	S0153/19
No change valve	S0151/20	S0151/20	S0151/20	S0151/20	S0151/20
Drainage kit	S0151/21	S0151/21	S0151/21	S0151/21	S0151/21
Top head with drainage	S0151/42	S0151/22	S0151/62	S0152/22	S0153/22
Non-porous disc (2 units)	S0151/43	S0151/23	S0151/63	S0152/23	S0153/23

Quick connectors

- S0155 Male quick connector
- S0155/1 Female quick connector



Pressure and distributor display panels

PROETISA manufactures a wide range of panels for all our customers' needs. The panels are completely interconnectable. New panels can be added to the basic configuration of a simple triaxial to turn it into a complex triaxial.

The pressure display panels are equipped with high resolution pressure gauges with a diameter of 260 mm. These are used to measure the pressure applied to the sample, to distribute the water in the system and to interconnect to the regulation panels. Designed for independent or joint operation.

S0219 Pump pressure display panel

Designed to work with air / water or oil / water pressure systems. This panel can be used to control pore pressures and to provide fine control of the pressure while the system is using the rotary hand pump. The panel has a pressure gauge of 260 mm diameter. It is equipped with four non-volumetric intake / outlet switch valves, one circuit bleeding valve, a water intake valve (supplies the entire circuit), a rotary hand pump controlled by a screw, bleeder and isolating valves for the pressure gauge and the circuits. Using the isolating valve, the panel can be used to control the cell or pore pressure.

Characteristics

- Pressure gauge from 0 to 10 Kg-cm².
- Screw-controlled rotary type pump.
- Made of stainless steel.
- Modular design for additional flexibility.
- Wall or bench mounted.

The panel can be connected to a two-pressure system for the following tests: TUU (triaxial unconsolidated, undrained), TCD (triaxial consolidated and drained) and TCU (triaxial consolidated undrained).

For higher work loads, it should be connected to the **S0220** Six-way pressure reducer panel. In addition, the system can control as many as six different pressures, all of which are displayed on the **S0219** pressure gauge. This allows the system to perform two consolidations at the same time as a triaxial test or two permeability tests are performed in the press.

The panel can handle up to four **S0220**, for a total of as many as 24 different pressures.



S0219/1 Pressure display panel

Designed to work with air / water or oil / water pressure systems. This panel can be used to distribute the water to the various systems and to facilitate system maintenance operations, such as bleeding, etc.

The panel has a pressure gauge of 260 mm diameter. It has four non-volumetric intake / outlet switch valves, one circuit bleeding valve and one water intake valve (supplies the entire circuit).

Characteristics

Pressure gauge from 0 to 10 Kg-cm².

Made of stainless steel.

Modular design for additional flexibility.

Wall or bench mounted.

The panel can be connected to a two-pressure system for the following tests: TUU (triaxial unconsolidated, undrained), TCD (triaxial consolidated and drained) and TCU (triaxial consolidated undrained).

For higher work loads, it should be connected to the **S0220** Six-way pressure reducer panel. In addition, the system can control as many as six different pressures, all of which are displayed on the **S0219** pressure gauge. This allows the system to perform two consolidations at the same time as a triaxial test or two permeability tests are performed in the press.

The panel can handle up to four **S0220**, for a total of as many as 24 different pressures.

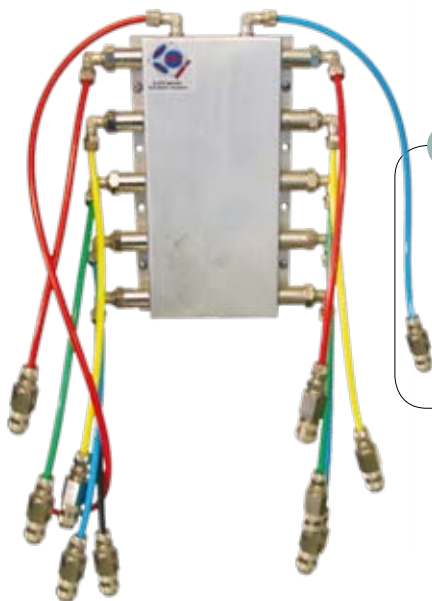

S0219/2 Pressure multiplier block 1/12

Made entirely of aluminium. Used to multiply the number of pressure outlets. If the system provides lateral confinement pressure and several outlets with the same pressure are required, the multiplier block can multiply the pressure by up to 12 times. In this case, it would act on twelve triaxial cells.

S0219/3 Pressure multiplier block 2/6

Made entirely of aluminium. Used to multiply the number of pressure outlets. If the system provides lateral confinement pressure and several outlets with the same pressure are required, the multiplier block can multiply the pressure by up to 6 times. In this case, it would act on six triaxial cells. This block can handle two intakes and six outlets for each one.

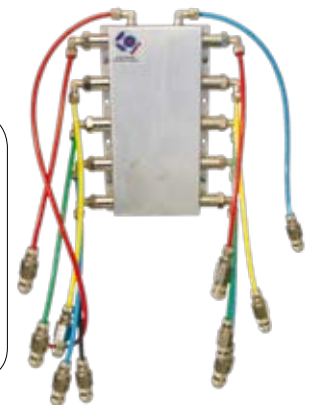

Pressure regulation panels:

Designed for independent or joint operation.

There are six types of panels to meet all possible needs of the end user. Four-pressure systems, four-pressure systems with independent pressure gauges, six-pressure systems, six-pressure systems with independent pressure gauges, four-pressure systems with 260 mm diameter independent pressure gauge with pressure display and six-pressure systems with independent 260 mm independent pressure gauge. All models can be interconnected and expanded. Some are completely independent and others are operated via panels **S0219** and **S0219/1**.

S0220/2 Four-way pressure regulation panel

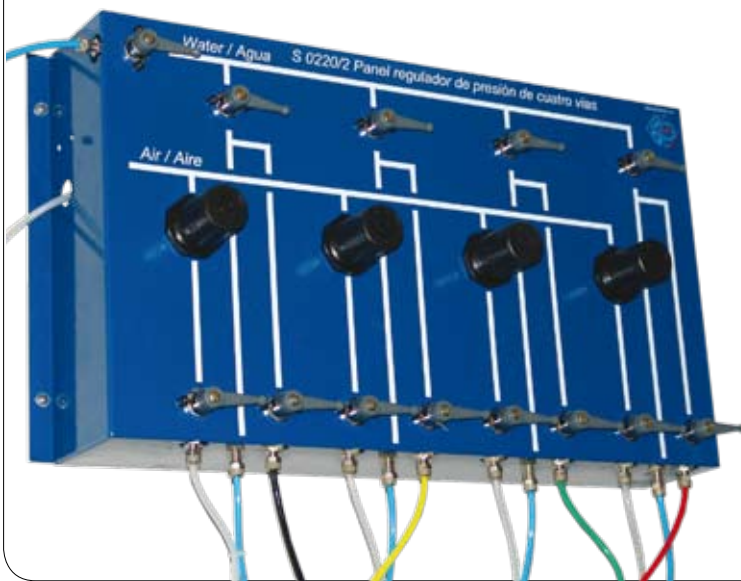

The panel can run with four different pressures at the same time: TUU (triaxial unconsolidated, undrained), TCD (triaxial consolidated and drained) and TCU (triaxial consolidated undrained).

The panel has two intakes, one for air and the other for water. Air and water are distributed separately by Legris valves. The pressures are obtained, monitored and maintained automatically by pressure regulators. The panel has four regulators, one for each pressure.

It must be connected to a pressure display panel, either the **S0219** pressure display panel with screw-operated pump or the **S0219/1** pressure display panel (without a pump). This allows control of up to four different pressures that are displayed on the **S0219** pressure gauge or on the **S0219/1**. The system can perform a consolidation while a triaxial test or permeability is being performed by the press.

S0220 Six-way pressure regulation panel

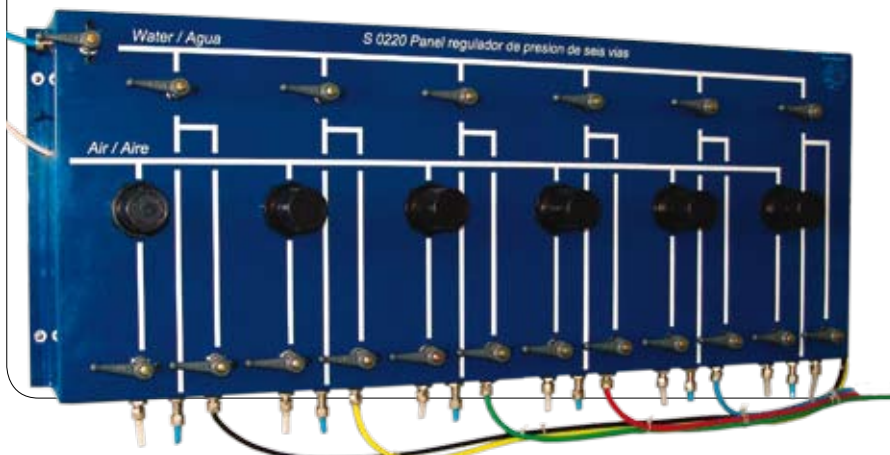

The panel can run with six different pressures at the same time: TUU (triaxial unconsolidated, undrained), TCD (triaxial consolidated and drained) and TCU (triaxial consolidated undrained).

The panel has two intakes, one for air and the other for water. Air and water are distributed separately by Legris valves. The pressures are obtained, monitored and maintained automatically by pressure regulators. The panel has six regulators, one for each pressure.

It must be connected to a pressure display panel, either the **S0219** pressure display panel with screw-operated pump or the **S0219/1** pressure display panel (without a pump). This allows control of up to six different pressures that are displayed on the **S0219** pressure gauge or on the **S0219/1**. This allows the system to perform two consolidations at the same time as a triaxial test or two permeability tests are performed in the press.



S0220/1 Six-way pressure regulation panel with pressure gauges

The panel can run with six different pressures at the same time: TUU (triaxial unconsolidated, undrained), TCD (triaxial consolidated and drained) and TCU (triaxial consolidated undrained).



Unlike the **S0220** this panel displays all the selected pressures simultaneously. The panel has two intakes, one for air and the other for water. Air and water are distributed separately by Legris valves. The pressures are obtained, monitored and maintained automatically by pressure regulators. The panel has six regulators, one for each pressure. If turned clockwise, the pressure increases and if turned anticlockwise, the pressure is reduced. These changes can be viewed in real time on the pressure gauge.

It can be connected to a pressure display panel (optional, the system does not require the panel), choosing either the **S0219** pressure display panel with screw-operated pump or the **S0219/1** pressure display panel (without a pump). The pressures are controlled separately and can be viewed on the panel itself or on the pressure gauge of the **S0219** or **S0219/1**. The system can perform a consolidation while a triaxial test or permeability is being performed by the press.

S0220/3 Four-way pressure regulation panel with pressure gauges

The panel can run with four different pressures at the same time: TUU (triaxial unconsolidated, undrained), TCD (triaxial consolidated and drained) and TCU (triaxial consolidated undrained).

Unlike the **S0220/2** this panel displays all the selected pressures simultaneously. The panel has two intakes, one for air and the other for water. Air and water are distributed separately by Legris valves. The pressures are obtained, monitored and maintained automatically by pressure regulators. The panel has four regulators, one for each pressure. If turned clockwise, the pressure increases and if turned anticlockwise, the pressure is reduced. These changes can be viewed in real time on the pressure gauge.

It can be connected to a pressure display panel (optional, the system does not require the panel), choosing either the **S0219** pressure display panel with screw-operated pump or the **S0219/1** pressure display panel (without a pump). The pressures are controlled separately and can be viewed on the panel itself or on the pressure gauge of the **S0219** or **S0219/1**. The system can perform a consolidation while a triaxial test or permeability is being performed by the press.



S0220/5 Four-way pressure regulation panel with pressure gauge

The panel can run with four different pressures at the same time: TUU (triaxial unconsolidated, undrained), TCD (triaxial consolidated and drained) and TCU (triaxial consolidated undrained). Unlike the **S0220/2** this panel does not allow simultaneous viewing of all the pressures selected, although it includes a high resolution 260 mm diameter pressure gauge that is highly accurate. The panel has two intakes, one for air and the other for water.

Air and water are distributed separately by Legris valves. The pressures are obtained, monitored and maintained automatically by pressure regulators. The panel has four regulators, one for each pressure. If turned clockwise, the pressure increases and if turned anticlockwise, the pressure is reduced. These changes can be viewed in real time on the pressure gauge.

It can be connected to a pressure display panel (optional, the system does not require the panel), choosing either the **S0219** pressure display panel with screw-operated pump or the **S0219/1** pressure display panel (without a pump). The pressures are controlled separately and can be viewed on the panel itself or on the pressure gauge of the **S0219** or **S0219/1**. The system can perform a consolidation while a triaxial test or permeability is being performed by the press.



S0220/6 Six-way pressure regulation panel with pressure gauge

The panel can run with six different pressures at the same time: TUU (triaxial unconsolidated, undrained), TCD (triaxial consolidated and drained) and TCU (triaxial consolidated undrained).

Unlike the **S0220/5** this panel does not allow simultaneous viewing of all the pressures selected, although it includes a high resolution 260 mm diameter pressure gauge that is highly accurate. The panel has two intakes, one for air and the other for water. Air and water are distributed separately by Legris valves. The pressures are obtained, monitored and maintained automatically by pressure regulators. The panel has six regulators, one for each pressure. If turned clockwise, the pressure increases and if turned anticlockwise, the pressure is reduced. These changes can be viewed in real time on the pressure gauge.

It can be connected to a pressure display panel (optional, the system does not require the panel), choosing either the **S0219** pressure display panel with screw-operated pump or the **S0219/1** pressure display panel (without a pump). The pressures are controlled separately and can be viewed on the panel itself or on the pressure gauge of the **S0219** or **S0219/1**. The system can perform a consolidation while a triaxial test or permeability is being performed by the press.

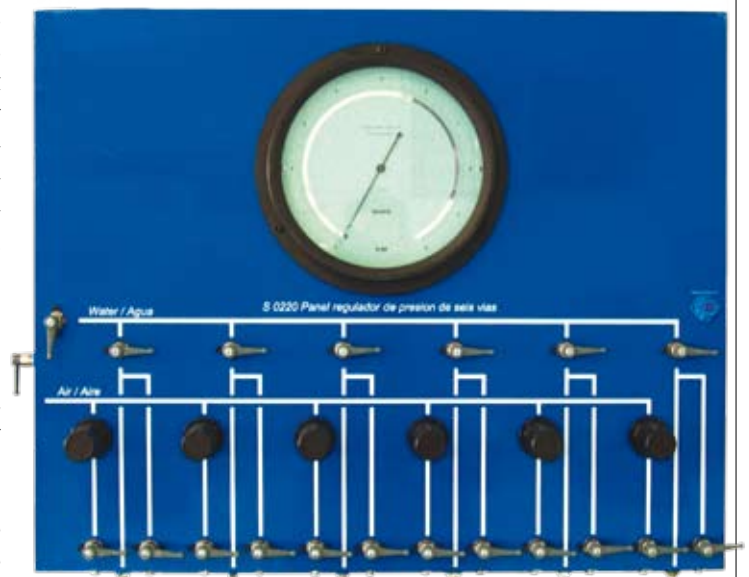

S0220/3D Four-way pressure regulation panel with digital pressure gauges

The panel can run with four different pressures at the same time: TUU (triaxial unconsolidated, undrained), TCD (triaxial consolidated and drained) and TCU (triaxial consolidated undrained).

Like the **S0220/3** this panel also displays all the selected pressures simultaneously. The panel has two intakes, one for air and the other for water. Air and water are distributed separately by Legris valves. The pressures are obtained, monitored and maintained automatically by pressure regulators. The panel has four regulators, one for each pressure. If turned clockwise, the pressure increases and if turned anticlockwise, the pressure is reduced. These changes can be viewed in real time on the pressure gauge.

It can be connected to a pressure display panel (optional, the system does not require the panel), choosing either the **S0219** pressure display panel with screw-operated pump or the **S0219/1** pressure display panel (without a pump). The pressures are controlled separately and can be viewed on the panel itself or on the pressure gauge of the **S0219** or **S0219/1**. The system can perform a consolidation while a triaxial test or permeability is being performed by the press.

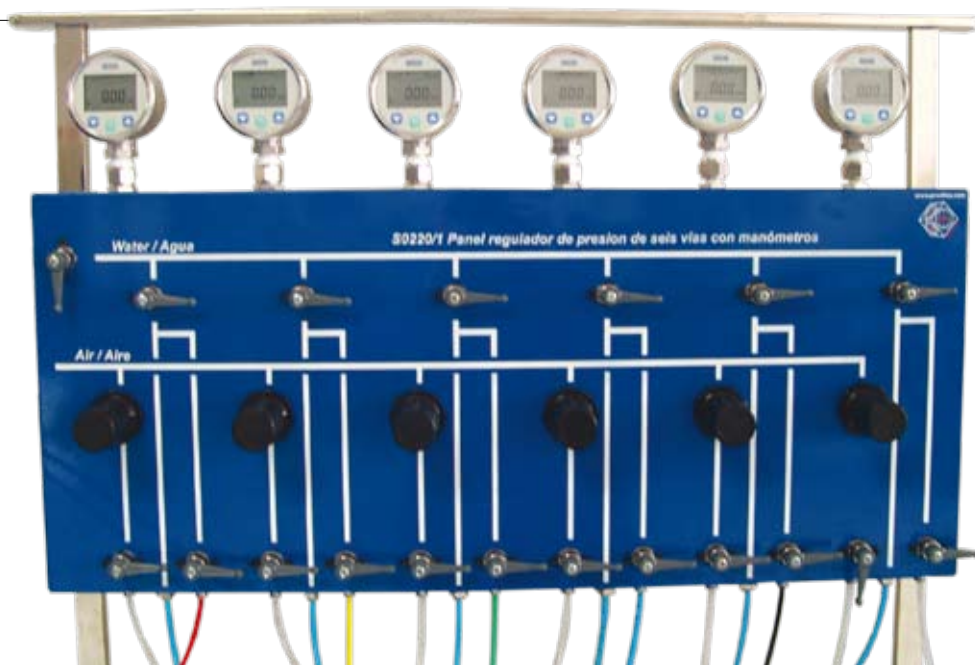

S0220/1D Six-way pressure regulation panel with digital pressure gauges

The panel can run with six different pressures at the same time: TUU (triaxial unconsolidated, undrained), TCD (triaxial consolidated and drained) and TCU (triaxial consolidated undrained).

Like the **S0220/4** this panel also displays all the selected pressures simultaneously. The panel has two intakes, one for air and the other for water. Air and water are distributed separately by Legris valves. The pressures are obtained, monitored and maintained automatically by pressure regulators. The panel has six regulators, one for each pressure. If turned clockwise, the pressure increases and if turned anticlockwise, the pressure is reduced. These changes can be viewed in real time on the pressure gauge.

It can be connected to a pressure display panel (optional, the system does not require the panel), choosing either the **S0219** pressure display panel with screw-operated pump or the **S0219/1** pressure display panel (without a pump). The pressures are controlled separately and can be viewed on the panel itself or on the pressure gauge of the **S0219** or **S0219/1**. The system can perform a consolidation while a triaxial test or permeability is being performed by the press.

Triaxial test pressure systems



Oil / water system

S0226 A motor-driven oil / water pressure system for pressures up to 3500 kPa. This apparatus supplies constant infinitely adjustable pressure, using a static control system with an adjustable spring connected online to a pump and interchangeable oil/water tank.

The apparatus consists of a motor-driven hydraulic pump, a spring/smooth piston unit, a cylindrical oil/water replacement tank, valves and oil.

Dimensions: 300 x 300 x 380 mm

Approx. weight: 15 Kg

Air / water system

In air/water systems, pressurisation is by compressed air. For operation, the system requires a water tank, a compressor and air/water cells. As in the triaxial tests, deaerated water is used. Sometimes, the water tank is replaced with a deaerator that already includes deaerated water.

S0225 Water tank.

Made of high strength plexiglass, with 50-litre capacity. The tank is equipped with a water intake valve and an outlet valve.

S0181 Deaerating water tank.

Holds 20 litres. Equipped with a vacuum pump and a pump that moves the water to speed up the process. The tank can prepare 20 litres of deaerated water in approximately 60 minutes. The tank comes with a selector with four positions: tank fill, water supply, deaerator and switched off.



System with air / water membrane cell

S0169 Air/Water membrane cell that supplies up to 16 Kg/cm² of pressurised water to the cell.

Dimensions: Ø 160 x 380 mm

Weight: 3 Kg

Spare parts

S0169/1 Spare membrane

S0169/2 High pressure flange

S0170 Laboratory compressor, max. pressure 10 Bar

S0150/3 Nylon tube dia. 6 X 4 mm, in 20 m rolls



S0200 Data acquisition unit with 16 channels

This unit has been developed to perform data acquisition from force, displacement, pressure and volume change transducers, as well as for any device that generates an electric signal.

It can connect and collect data simultaneously from 16 devices. In turn, the unit is connected to a computer that uses software to collect and process the data. The computer requires an N.I card.

A single unit can control one triaxial (four channels), a workbench with three oedometers (three channels) and a set of direct shear apparatus (three channels), leaving six channels free.

All the parameters associated with drained and undrained triaxial tests, i.e., axial loads, axial deformation, interstitial pressure, counter-pressure and volume change can be processed by the unit.



Software for geotechnical tests

50231 Data collection application

- 50234 Triaxial test package
 - Simple compression (CSP)
 - Triaxial fast (TUU)
 - Triaxial consolidated (TCU)
 - Triaxial consolidated and drained (TCD)
 - Saturation measurement test (SAT)
 - Velocity determination test (VEL)
 - Permeability test.

- 50232 Oedometric test package.
 - Standard oedometer (EDO)
 - Free swelling (HIL)
 - Swelling pressure (PHI)

- 50233 Direct shear test package
 - Rectangular direct shear (COR)
 - Circular direct shear (COC)
 - Velocity determination test (VEL)

- 50235 Marshall test
- 50236 CBR test



The **DATA COLLECTION** application is common to all tests. This application includes highly intuitive menus that allow the user to choose predefined tests and to create new tests with new control parameters that are particularly useful for research centres. The sensors are also managed with this application, which enables them to be registered, deregistered, calibrated, etc.

The software can be used to control a large number of tests simultaneously and allow them to be viewed in real time. It also has data backup capability in the event of power outage.

The **DATA ANALYSIS** application is used to study the results of direct shear, oedometer, triaxial tests, etc.



The software runs subject to user selection. There is a manager role for generation and definition of tests in addition to having rights to register and deregister the sensors. There is also an operator role for carrying out the tests without being able to manipulate the settings, so that all the information is kept safe.

The programme also allows remote access.

The main features of this system are as follows:

- Direct data acquisition by the transducers connected to the data acquisition unit **50200**,
- Test monitoring and viewing in real time.
- Multitask software for simultaneous performance of oedometric, direct shear, triaxial tests, etc, without loss of information.
- Optional machine-controlling software
- Manual introduction by the operator of the corresponding data during test performance and analysis. The software runs the test and the operator can introduce sample data such as the client, project and so on before, during or after the test
- All the data relating to a test or sample can be viewed at any time, simultaneously.



S0231 Data collection application (continued)

Sensors

The software contains an exclusive menu for the sensors.

The user can:

- Register new sensors
- Deregister sensors
- List all the sensors
- Edit sensor calibration
- Use a guided sensor calibration menu
- Check sensor status.

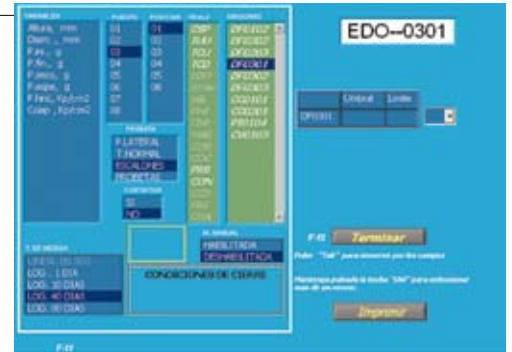

Tests

The software contains an exclusive menu for tests.

The user can:

- Register new tests
- Deregister tests
- List all the tests
- Edit the tests
- Create free tests

The figure shows the settings for a consolidated, undrained triaxial test.

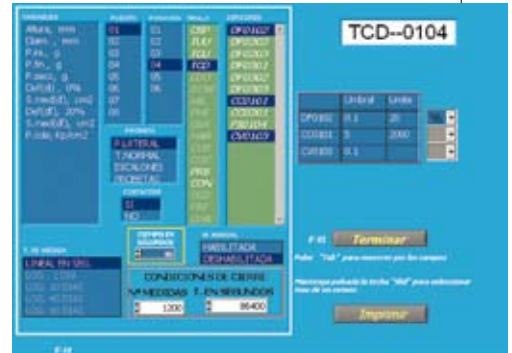

Configuration of an oedometric test.

Test configuration is a fundamental characteristic of the software. This powerful tool allows the user to instruct the computer how, when, and how often to collect data. The user can also define criteria for ending the test

The software can run several tests simultaneously and view them in real time.

The tests can be stopped at any time while they are being performed and continued later without problem.

The software is multilanguage, allowing the user to change the operating language.

When the tests are finished, the data or results are processed by the data analysis application.

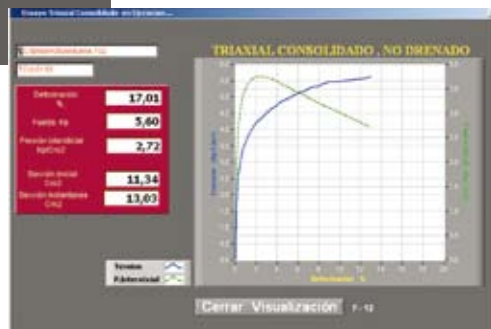

Software for geotechnical tests

Other software characteristics

- Automatic interpolation of the entered data
- Restoration of the results, both tables and graphs, with preview in video
- Automatic call-up of the data processed by the various modules
- Printing of results
- Test file with backup and restore capabilities
- Automatic search of saved tests
- Printer selection
- Simple test cancellation option
- Automatic management of data saved with direct acquisition
- Windows operating system
- Automatic data protection in the event of power outage.
- Data export via screen, printer or Excel.
- Multilanguage

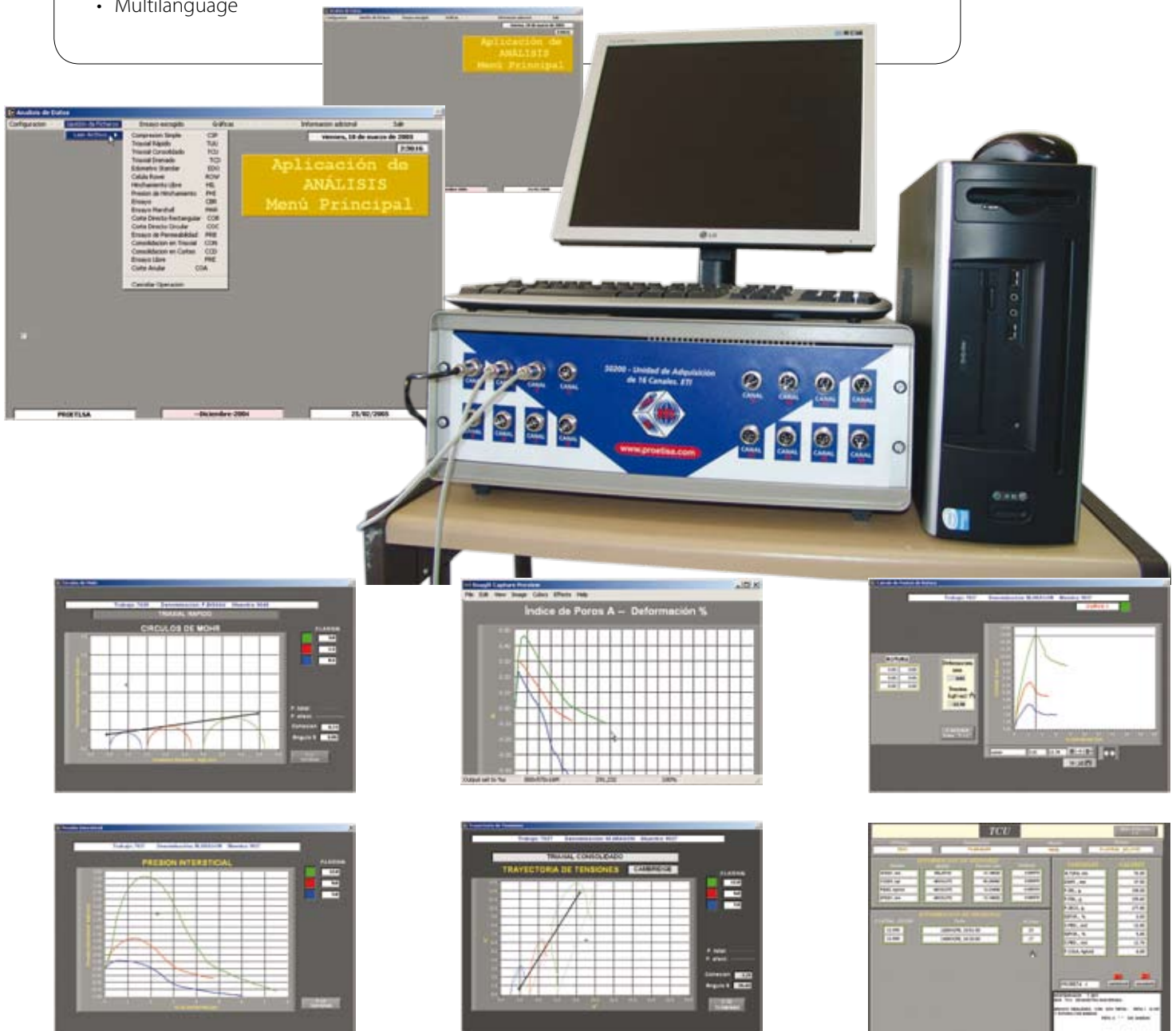

Optional triaxial test settings

Triaxial two-pressure system

Consisting of:

Quant	Code	Description
1	S0150	Triaxial load frame
1	V0029	20 kN force transducer
1	S0239	Axial displacement transducer, 50 mm
1	S0175	Pressure transducer
1	S0240	Volume change transducer
1	S0219	Universal panel with pump
2	S0169	Air / water membrane cell
1	S0200	Data acquisition unit with 16 channels
1	S0234	Software for triaxial tests
1	S0150/1	Loading piston
1	S0220/4	Pneumatic two-way regulating panel s/m
1	S0151	Triaxial cell
1	S0151/30	Base adapter for samples of \varnothing 38 mm
1	S0151/42	Top head for drainage of \varnothing 38 mm samples
1	S0150PC	PC

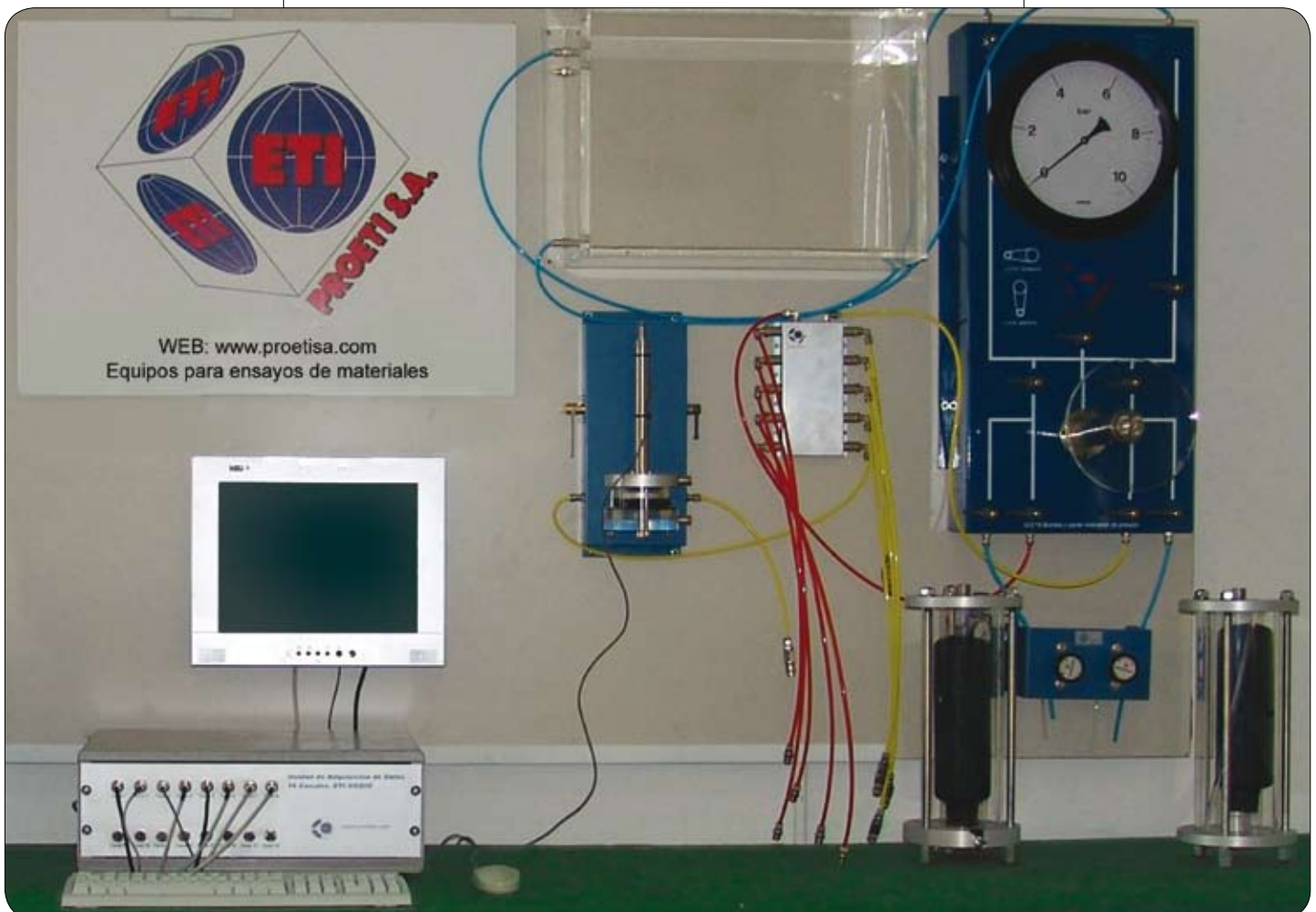

Triaxial four-pressure system

Quant	Code	Description
1	S0150	Triaxial load frame
1	V0029	20 kN force transducer
1	S0239	Axial displacement transducer, 50 mm
1	S0175	Pressure transducer
1	S0240	Volume change transducer
1	S0220/3	Four-way pressure regulation panel with pressure gauges
4	S0169	Air / water membrane cell
1	S0200	Data acquisition unit with 16 channels
1	S0234	Software for triaxial tests
1	S0150/1	Loading piston
1	S0151	Triaxial cell
1	S0151/30	Base adapter for samples of Ø 38 mm
1	S0151/42	Top head for drainage of Ø 38 mm samples
1	S0150PC	PC

Quant	Code	Description
1	S0150	Triaxial load frame
1	V0029	20 kN force transducer
1	S0239	Axial displacement transducer, 50 mm
1	S0175	Pressure transducer
1	S0240	Volume change transducer
1	S0219/1	Universal panel without pump
1	S0220/2	Four-way pressure regulation panel without pressure gauges
4	S0169	Air / water membrane cell
1	S0200	Data acquisition unit with 16 channels
1	S0234	Software for triaxial tests
1	S0150/1	Loading piston
1	S0151	Triaxial cell
1	S0151/30	Base adapter for samples of Ø 38 mm
1	S0151/42	Top head for drainage of Ø 38 mm samples
1	S0150PC	PC



Triaxial six-pressure system

Quant	Code	Description
1	S0150	Triaxial load frame
1	V0029	20 kN force transducer
1	S0239	Axial displacement transducer, 50 mm
1	S0175	Pressure transducer
1	S0240	Volume change transducer
1	S0220/1	Six-way pressure regulation panel with pressure gauges
6	S0169	Air / water membrane cell
1	S0200	Data acquisition unit with 16 channels
1	S0234	Software for triaxial tests
1	S0150/1	Loading piston
1	S0151	Triaxial cell
1	S0151/30	Base adapter for samples of \varnothing 38 mm
1	S0151/42	Top head for drainage of \varnothing 38 mm samples
1	S0150PC	PC

Quant	Code	Description
1	S0150	Triaxial load frame
1	V0029	20 kN force transducer
1	S0239	Axial displacement transducer, 50 mm
1	S0175	Pressure transducer
1	S0240	Volume change transducer
1	S0219/1	Universal panel without pump
1	S0220	Six-way pressure regulation panel without pressure gauges
6	S0169	Air / water membrane cell
1	S0200	Data acquisition unit with 16 channels
1	S0234	Software for triaxial tests
1	S0150/1	Loading piston
1	S0151	Triaxial cell
1	S0151/30	Base adapter for samples of \varnothing 38 mm
1	S0151/42	Top head for drainage of \varnothing 38 mm samples
1	S0150PC	PC



Triaxial six or four-pressure system

Quant	Code	Description
1	S0150	Triaxial load frame
1	V0029	20 kN force transducer
1	S0239	Axial displacement transducer, 50 mm
1	S0175	Pressure transducer
1	S0240	Volume change transducer
1	S0220/6	Six-way pressure regulation panel with pressure gauge
6	S0169	Air / water membrane cell
1	S0200	Data acquisition unit with 16 channels
1	S0234	Software for triaxial tests
1	S0150/1	Loading piston
1	S0151	Triaxial cell
1	S0151/30	Base adapter for samples of \varnothing 38 mm
1	S0151/42	Top head for drainage of \varnothing 38 mm samples
1	S0150PC	PC

Quant	Code	Description
1	S0150	Triaxial load frame
1	V0029	20 kN force transducer
1	S0239	Axial displacement transducer, 50 mm
1	S0175	Pressure transducer
1	S0240	Volume change transducer
1	S0220/5	Four-way pressure regulation panel with pressure gauge
4	S0169	Air / water membrane cell
1	S0200	Data acquisition unit with 16 channels
1	S0234	Software for triaxial tests
1	S0150/1	Loading piston
1	S0151	Triaxial cell
1	S0151/30	Base adapter for samples of \varnothing 38 mm
1	S0151/42	Top head for drainage of \varnothing 38 mm samples
1	S0150PC	PC



Triaxial six or four-pressure system

Quant	Code	Description
1	S0150	Triaxial load frame
1	V0029	20 kN force transducer
1	S0239	Axial displacement transducer, 50 mm
1	S0175	Pressure transducer
1	S0240	Volume change transducer
1	S0220/1D	Six-way pressure regulation panel with digital pressure gauges
6	S0169	Air / water membrane cell
1	S0200	Data acquisition unit with 16 channels
1	S0234	Software for triaxial tests
1	S0150/1	Loading piston
1	S0151	Triaxial cell
1	S0151/30	Base adapter for samples of \varnothing 38 mm
1	S0151/42	Top head for drainage of \varnothing 38 mm samples
1	S0150PC	PC

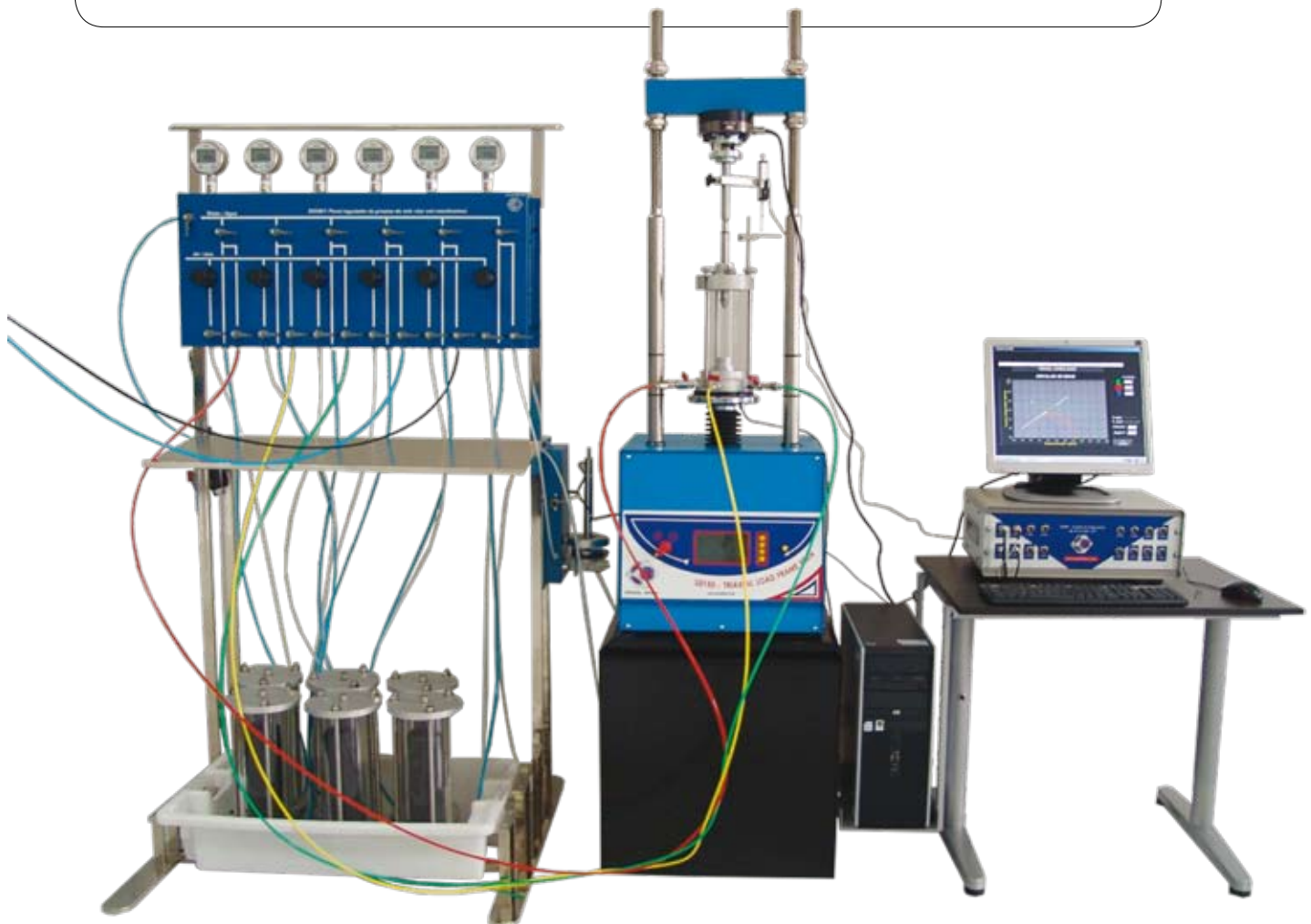

Compaction and CBR

Standards EN 13286-2; UNE 7365, 7255, 103-501/94; NLT-107/91, 107/98, 108/91, 108/98 ; ASTM D698, D1557, D1833; AASHTO T99, T180, T193; BS 1377:4, 1994 ; NF P94-093, P94-066 ; DIN 18127; DUTCH RAW, EPP

The compaction test is used to determine certain soil characteristics, such as:

- The ratio between dry density and moisture content determines the compaction factor;
- The optimum moisture content for efficient compaction;
- The maximum dry density obtained.

These characteristics make it possible to optimise the execution of projects that require use of the terrain as well as of filling material. International standards describe several compaction methods, the choice of which depends mainly on the soil, the equipment used for compaction “in situ” and the nature of the work.



Standard Proctor moulds

Made of steel tube protected against corrosion. Supplied with base and collar. Various models are available, in compliance with various international standards.

Reference	Description	Standard	Capacity cc	Int. diameter mm	Mould height	Weight Kg
S0254	Standard Proctor Mould	NLT-UNE	1000	102±0.4	122.4±0.1	8.5
S0255	Standard Proctor Mould with hinges	NLT-UNE	1000	102±0.4	122.4±0.1	9
S0256	Standard Proctor Mould	EN	942	100±1	120±1	8
S0257	Standard Proctor Mould with hinges	EN	942	100±1	120±1	8.5
S0258	Standard Proctor Mould	ASTM-AASHTO-NF-CNR	944	101.6	116.4	8
S0259	Standard Proctor Mould with hinges	ASTM-AASHTO-NF-CNR	944	101.6	116.4	8.5
S0260	Standard Proctor Mould	BS	1000	105	115.5	8
S0261	Standard Proctor Mould with hinges	BS	1000	105	115.5	8.5

Spare parts:

- S0254/1** Base for Standard Proctor moulds, in compliance with NLT
- S0254/2** Collar for Standard Proctor moulds, in compliance with NLT
- S0256/1** Base for Standard Proctor moulds, in compliance with EN
- S0256/2** Collar for Standard Proctor moulds, in compliance with EN
- S0258/1** Base for Standard Proctor moulds, in compliance with ASTM-AASHTO-NF-CNR
- S0258/2** Collar for Standard Proctor moulds, in compliance with ASTM-AASHTO-NF-CNR
- S0260/1** Base for Standard Proctor moulds, in compliance with BS
- S0260/2** Collar for Standard Proctor moulds, in compliance with BS



Modified Proctor moulds

Made of steel tube protected against corrosion. The base and collar must be ordered separately. Various models are available, in compliance with various international standards.



Reference	Description	Standard	Capacity cc	Int. diameter mm	Mould height	
S0262	Modified Proctor Mould	NLT-UNE	2320	152.5±0.7	127±0.1	12
S0263	Open Modified Proctor Mould	NLT-UNE	2320	152.5±0.7	127±0.1	12
S0264	Modified Proctor Mould with hinges	NLT-UNE	2320	152.5±0.7	127±0.1	12
S0269	Large Proctor Mould	EN	9817	250±1	200±1	30
S0276	Modified Proctor Mould	EN	2120	150±1	120±1	12
S0277	Open Modified Proctor Mould	EN	2120	150±1	120±1	12.5
S0278	Modified Proctor Mould with hinges	EN	2120	150±1	120±1	13
S0279	Modified Proctor Mould	ASTM-AASHTO-NF-CNR	2120	152.4	116.4	12
S0280	Open Modified Proctor Mould	ASTM-AASHTO-NF-CNR	2120	152.4	116.4	12.5
S0281	Modified Proctor Mould with hinges	ASTM-AASHTO-NF-CNR	2120	152.4	116.4	13
S0274	Modified Proctor Mould	NF	2120	152	152±0.5	12
S0275	Modified Proctor Mould with hinges	NF	2120	152	152±0.5	12

Accessories:

S0262/1 Round base for Modified Proctor moulds, in compliance with NLT-UNE

S0262/2 Square base for Modified Proctor moulds, in compliance with NLT-UNE

S0262/3 Collar for Modified Proctor moulds, in compliance with NLT-UNE

S0269/1 Base for Large Proctor moulds, in compliance with EN

S0269/2 Collar for Large Proctor moulds, in compliance with EN

S0276/1 Round base for Modified Proctor moulds, in compliance with EN

S0276/2 Square base for Modified Proctor moulds, in compliance with EN

S0276/3 Collar for Modified Proctor moulds, in compliance with EN

S0279/1 Base for Modified Proctor moulds, in compliance with ASTM-AASHTO-NF-CNR

S0279/2 Square base for Modified Proctor moulds, in compliance with ASTM-AASHTO-NF-CNR

S0279/3 Collar for Modified Proctor moulds, in compliance with ASTM-AASHTO-NF-CNR

S0274/1 Round base for Modified Proctor moulds, in compliance with NF

S0274/2 Square base for Modified Proctor moulds, in compliance with NF

S0274/3 Collar for Modified Proctor moulds, in compliance with NF



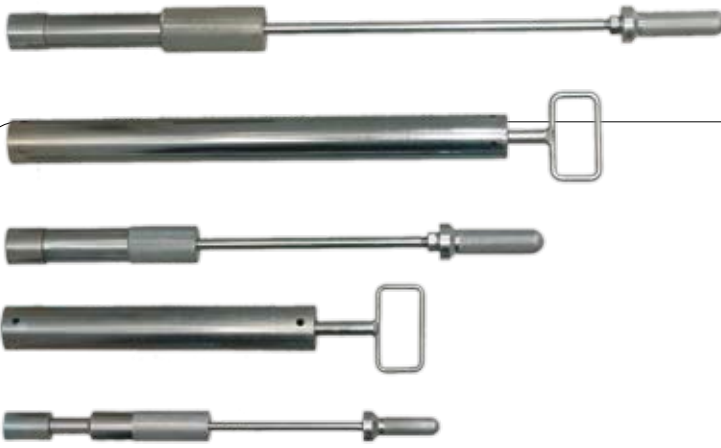

Proctor hammers

Used for manual compaction of soil samples in moulds. Available in two versions, in compliance with international standards, Army type or tubular. Made of steel protected against corrosion. As an alternative to manual compaction, we recommend the Automatic Compactor S0290.

Reference	Description	Standard	Hammer Ø mm	Fall height mm	Hammer weight Kg	Total weight Kg
S0252	Standard Proctor hammer, army	UNE-NLT	50.8	305	2.49	6
S0253	Standard Proctor hammer, tubular	ASTM-AASHTO-CNR-UNE-NLT	50.8	305	2.49	6
S0251	Standard Proctor hammer, tubular	EN 13286.2-NF-BS	50±0.5	305±3	2.5±0.02	6
S0265	Modified Proctor hammer, army	UNE-NLT	50.8	457.2	4.53	8
S0266	Modified Proctor hammer, tubular	ASTM-AASHTO-CNR-UNE-NLT	50.8	457.2	4.53	8
S0267	Modified Proctor hammer, tubular	EN 13286.2-NF-BS	50±0.5	457±3	4.5±0.04	8
S0269/4	Large Modified Proctor hammer, tubular	EN 13286:2- NF-BS	125±0.5	600±3	15±0.04	24

Steel plates

Used in compliance with standard EN to compact the last layer in the mould. Made of steel protected against corrosion. These have a threaded hole in the centre to attach a "T"-shaped handle.

- S0256/3 Compaction plate, Ø 99.5 x 10 mm thick
- S0276/6 Compaction plate, Ø 149.5 x 10 mm thick
- S0269/3 Compaction plate, Ø 249.5 x 20 mm thick

Harvard miniature test

This test is performed to compact soil with particles smaller than 5 mm, and small quantities of soil.

S0270 Harvard Mould

Made of steel protected against corrosion.

Dimensions: int. Ø 33.3 x 71.5 mm high.

S0271 Tamper with springs for 20 and 40 pounds of force.

S0272 Harvard Stand.

S0273 Harvard Hammer.



Soil-cement test

Standards NLT-301/72, 302/72, 303/72

S0255 Soil-cement mould with hinges

Made of steel protected against corrosion. The base and collar must be ordered separately

Dimensions: int. \varnothing 102 x 122.4 mm high.

Weight: 9 Kg

Accessories

S0254/1 Mould base

S0254/2 Mould collar

S0283 Capper for soil-cement specimens.

S0252 Army type hammer, 2.5 Kg



Gravel-cement test

Standards NLT -310/90

S0264 Gravel/cement mould with hinges

Made of steel protected against corrosion. The base and collar must be ordered separately.

Dimensions: int. \varnothing 152.4 x 127 mm high.

Weight: 12 Kg

Accessories

S0262/1 Mould base

S0262/2 Square mould base

S0262/3 Mould collar



Automatic compaction

Standards EN 13286-2; UNE 7365, 7255, 103-501/94; NLT-107/98, 108/98; ASTM D698, D1557, D1833; CNR No. 29,69; AASHTO T99, T180, T193; BS 1377:4, 1994 ; NF P94-093, P94-066 ; DIN 18127; DUTCH RAW, EPP

S0290 Proctor/CBR automatic compactor

This machine is designed for automatic compaction of PROCTOR and CBR specimens. It guarantees perfect compaction and repeatability of results.

The base of the compactor has a system that rotates the mould at the same time as the hammer compacts the sample, the horizontal movement of the base allows the blows to be distributed evenly over the whole of the surface of the sample.

Its universal attachment system can house Standard Proctor moulds of \varnothing 4" (100 mm), Modified Proctor CBR moulds of \varnothing 6" (150 mm), whether manufactured by our company or any other company.

The control module is separate from the machine and can be fixed to a wall or set on a stand. The test parameters can all be selected (standard, diameter of mould, cycle). The module also includes the main power switch, the impact counter and emergency stop button.

Perfect machine operation is guaranteed by three motors (rotation, base displacement and hammer elevation) that reduce the risk of inefficient operation. Compaction frequency is controlled by a microprocessor.



The machine has an electronic software program for completely automatic performance of compaction tests in compliance with the following standards:

EN 13286-2

Mould Ø 100±1 mm the machine distributes 25 hammer blows automatically:

- 20 blows distributed around the mould
- 5 blows in the centre of the mould

Mould Ø 150±1 mm the machine distributes 56 blows automatically:

- 6 blows distributed around the mould
- 1 blow in the centre of the mould
- the sequence is repeated 8 times

AFNOR NF P 94-093

Mould Ø 101.5±0.5 mm the machine distributes 25 blows automatically:

- 20 blows distributed around the mould
- 5 blows in the centre of the mould

Mould Ø 152±0.5 mm the machine distributes 56 blows automatically:

- 6 blows distributed around the mould
- 1 blow in the centre of the mould
- the sequence is repeated 8 times

UNE 7365, 7255, 103-501/94; NLT-107/98, 108/98

Mould Ø 101.5±0.5 mm the machine automatically distributes 3 cycles of 26 blows around the mould

Mould Ø 152±0.5 mm the machine distributes 60 blows automatically:

- 20 blows distributed around the mould
- 3 blows in the centre of the mould
- 18 blows around the mould and 2 in the centre
- 15 blows around the mould and 2 in the centre

BS 1377:4, 1924:2

Mould Ø 105 mm the machine automatically distributes 3 cycles of 27 blows around the mould

Mould Ø 152 mm the machine distributes 30 blows automatically:

- 1 cycle of 20 blows distributed around the mould
- 1 cycle of 10 blows distributed around the mould

ASTM D698, D1557, D1833

Mould Ø 4" (101.6 mm) the machine automatically distributes 3 cycles of 25 blows around the mould

Mould Ø 6" (152.4 mm) the machine distributes 56 blows automatically:

- 2 cycles of 36 blows distributed around the mould
- 9 blows around the mould
- 1 blow in the centre of the mould
- 9 blows around the mould
- 1 blow in the centre of the mould

Technical specifications:

- Hammer fall height: adjustable from 12" to 18" (300 or 450 mm).
- Hammer weight: 5.5 or 10 lb (2.5 or 4.5 Kg).
- Compaction speed: 1 blow every 2 seconds.
- Power supply: 220V 50 Hz, single phase
- Dimensions: 600 x 360 x 1700 mm
- Weight: 240 Kg

The machine is supplied with a digital display module and a set of hammers of the following sizes: $\varnothing 50\pm 0.2$ mm (2500 \pm 10 g) and $\varnothing 50\pm 0.2$ mm (4535 g). For EU countries, using the safety protector is mandatory.

Accessories:

S0290/1 Safety Protector, in compliance with the EU directive. The Protector consists of a plexiglass cabin with sheet metal sections and a safety microswitch that automatically stops the compaction process if the door opens. The protector isolates the operator from the test area and provides protection from any risk of entanglement.

S0290/5 Standard Proctor hammer, $\varnothing 51\pm 1$ mm and weight of 2490 \pm 2.5 g. Complies with NF P94093

S0290/6 Modified Proctor hammer, $\varnothing 51\pm 1$ mm and weight of 4535 \pm 5 g. Complies with NF P94093

S0290/7 Protection cabin with noise insulation, in compliance with EU directive. The cabin includes a safety microswitch that automatically stops the compaction process if the door opens. The cabin isolates the operator from the test area and provides protection from any risk of entanglement.

Spare parts:

S0290/2 Hammer carrying tube

S0290/3 Standard Proctor hammer, $\varnothing 50.8$ mm and weight of 2500 g. Complies with EN 13286-2; BS 1377:4, UNE 7255,7365, 103-501/94, NLT 107/98 108/98; DIN 18127

S0290/4 Modified Proctor hammer, $\varnothing 50.8$ mm and weight of 4500 g. Complies with EN 13286-2; BS 1377:4, UNE 7255, 7365, 103-501/94, NLT 107/98 108/98; DIN 18127



Standards NLT-107, 108, 111, 59; AASHTO T -99; ASTM D698, D1557, D1883
S292 Proctor/CBR automatic compactor

This equipment has been especially developed for compacting soil samples in Standard Proctor, Modified Proctor, CBR and Marshall test and, in general terms, any user-defined compaction test.

The machine consists of:

A metal rack with a four-point anchoring system at the bottom that acts as a support for all the mechanical systems of the machine. The front of the rack has a plexiglass window through which the compaction hammer mechanism system can be viewed.

A set of electromagnetic fastening clamps that lift and release the hammer, equipped with rotation adjustment to adapt to the various tests to be performed. The fastening clamps are also equipped with rubber parts that are easy to replace in the event of excessive wear.

The significant advantage of this system over other chain-driven systems or similar is that wear and deterioration due to fatigue are limited to the rubber parts of the fastening clamps, since these are the only parts of the equipment that are in contact with the compaction hammer.

Control and display module.

The machine includes the following accessories for soil testing:

- A tube or hammer for CBR, Standard Proctor and Modified Proctor tests.
- A special steel base for Standard Proctor moulds.
- A special steel base for CBR and Modified Proctor moulds.
- A special hardened steel hammer stand for Standard Proctor.
- A special hardened steel hammer stand for Modified Proctor.
- A special hardened steel hammer stand for CBR.

Accessories for the Marshall test:

- A tube or hammer for the Marshall test.
- A special hardened steel hammer stand for Marshall.
- A Marshall tamper.
- A Marshall mould holder.

Technical characteristics

Electrical connections: 220 or 380, three phase.

Consumption: 1200 W

Approximate weight of the unit: 275 Kg

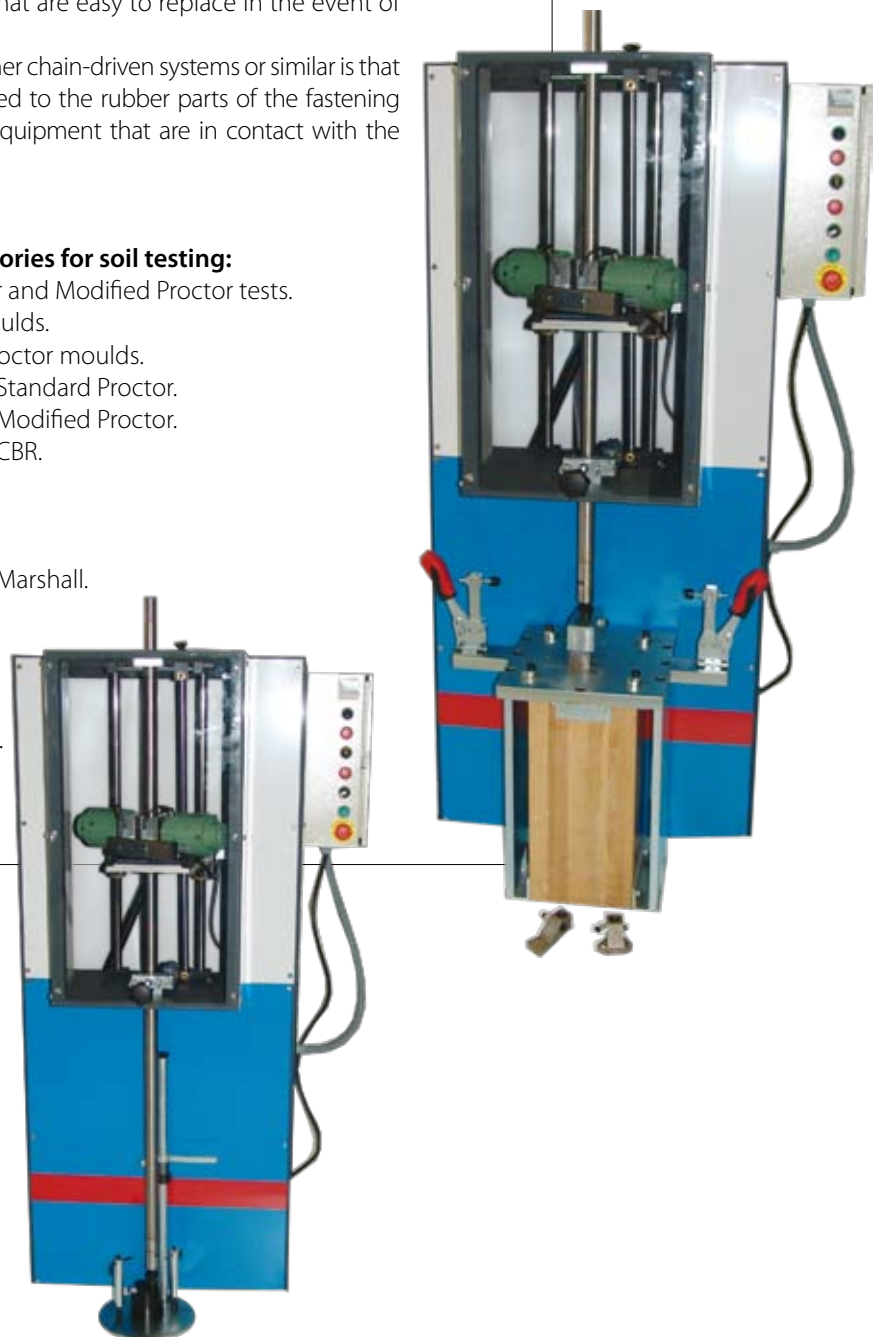

Vibrating hammer compaction

Standards NLT-310, 311; BS 1377, 1924

The vibrating hammer is an alternative method for compaction of soil samples, used to determine the dry density and moisture content ratio (Proctor), free lateral expansion (ELL) on stabilised terrain and for CBR tests.



S0293 Vibrating hammer

For soil compaction, supplied with a power connection cable and a carrying case.

Vibration frequency: 2750 impacts/minute.

Accessories

S0294 Tool carrier

S0295 Tamper, Ø 146 mm, used for CBR, gravel-cement tests, etc.

S0296 Tamper for ELL test. The distance between the centring disc and the base is 50 mm

S0297 Tamper for ELL test. The distance between the centring disc and the base is 100 mm

S0298 Tamper for ELL test. The distance between the centring disc and the base is 150 mm

S0299 Stand for safer, more even compaction.

Built on a steel structure housing the hammer and the mould.



CBR (California Bearing Ratio) test

Standards EN 13286-47, EN 13286-4 ; UNE 103-502; NLT -111/87; ASTM D1883/73; AASHTO T193; BS 1377:4, 1924:2 ; NF P94-078, P94-093, P98-231

The CBR test was developed by the California Department of Transportation in 1929 as a way to classify the capacity of soil to be used as base material for road construction.

This test is used to evaluate the load bearing capacity of soil used for flexible paving. The test consists of pushing in a round standard-sized piston (Ø 2") at constant speed and measuring the force required for penetration.

CBR moulds

Made of steel tube protected against corrosion. The base and collar must be ordered separately. Various models are available, in compliance with various international standards.



CBR moulds

DESCRIPTION	STANDARDS			
	ASTM D1883/73 AASHTOT193 UNE103-502 NLT 111/87	EN 13286-47	NF P94-078 NF P94-093	EN 13286-4 BS 1377:4 BS 1924:2
CBR mould Ø 152.4 x 177.8 mm	S0300			
CBR mould Ø 150 x 120 mm		S0276		
CBR mould Ø 152 x 152 mm			S0274	
CBR mould Ø 152 x 127 mm				S0262
Split CBR mould Ø 152.4 x 177.8 mm	S0301			
Split CBR mould Ø 150 x 120 mm		S0277		
Split CBR mould Ø 152 x 127 mm				S0263
Hinged CBR mould Ø 152.4 x 177.8 mm	S0302			
Hinged CBR mould Ø 150 x 120 mm		S0278		
Hinged CBR mould Ø 152 x 152 mm			S0275	
Hinged CBR mould Ø 152 x 127 mm				S0264
Round perforated base for CBR mould	S0304	S0276/4	S0274/4	S0262/4
Square perforated base for CBR mould	S0303	S0276/5	S0274/5	S0262/5
Spacer disc Ø 150.8 x 61.4 mm h	S0305			
Spacer disc Ø 151 x 36 mm h			S0274/6	
Spacer disc Ø 150 x 50 mm h				S0262/6
Perforated plate with extending rod	S0308	S0276/7	S0308	S0308
Smooth plate with extending rod		S0276/8		
Swell Tripod		S0306		
Screed 300x30x3 mm		S0320		
Bevel screed 300x30x3 mm		S0321		
Annular surcharge weight 2270 g.	S0309			
Annular surcharge weight 2300 g.			S0309/2	
Annular surcharge weight 2000 g.		S0309/1		S0309/1
Split surcharge 2270 g.	S0310			
Split surcharge 2300 g.			S0310/2	
Split surcharge 2000 g.		S0310/1		S0310/1
Annular surcharge weight 4540 g.	S0311			
Split surcharge 4540 g.	S0312			
Ring with cutting edge	S0314			S0314
Filter paper Ø 150 mm (100 units)		S0313		
Curing tank 600x400x400 mm		S0318		

CBR Test load Frames

Standards EN 13286-47; UNE 103-502; NLT -111/87; ASTM D1833; AASHTO T193; BS 1377:4; NF P94-078

Proeti has designed several alternative machines to perform the CBR penetration test.

Depending on user needs, we can offer machines with a single speed of 1.27 mm/min (1 mm/min, in compliance with standard BS) for specific CBR tests. Machines with two speeds to run CBR and Marshall tests. Machines with variable speed to perform the above mentioned tests as well as Duriez tests, indirect tensile tests with Marshall specimens, fast triaxial tests and unconfined tests. And finally, our highly versatile Multitest Machine that can be used in most standard tensile and bending tests (see the description in Multitest Machines).

PROETI test machines are basically built with a two-column sturdy structure, a shaft and an upper height adjustable cross-head that is firmly attached to the two columns.

The entire test area is firmly attached to the bottom plate over a convenient and compact support base that houses the motor, transmission, shaft, transducer and the control and safety mechanisms.

The top crosshead holds the measurement unit (dynamometric ring or load cell). The user can adjust the height in order to attach the various accessories needed to perform the tests (compression plate, bending device, penetration piston, etc...).

Models:

Reference	S0348	S0349	S0350	S0351	S0355
Test speed (mm/min)	1.27	1	1.27/50.8	1/50.8	0.1 – 63
Maximum vertical span	320 mm				
Upper cross-head adjustment	460 mm				
Horizontal span	270 mm				
Stroke of plate	200 mm				
Connection	3/8"				
Power supply	1 x 230 V / 50 Hz				
Dimensions	560 x 380 x 1480 mm				

Weight

99 Kg

117 Kg

156 Kg





S0348 CBR Loading Machine motorized, 50 kN capacity. ASTM version -1,27m/

Motor-driven CBR press, consisting of a sturdy frame with two columns and swivel upper cross-head, with threaded bars for height adjustment. Powered by a gearbox at a constant speed of 1.27 mm/min, with double end-stop to halt the bottom plate automatically.

Complete with control panel, main power switch, lifting/lowering inverter and official ENAC calibration certificate.

The measurement system and the accessories must be ordered separately.

Maximum capacity: 50 kN

Test speed: 1.27 mm/min

Maximum vertical span: 320 mm

Upper cross-head adjustment: 460 mm

Horizontal span: 270 mm

Stroke of bottom plate: 100 mm

Power supply: 220-240 V. 50 Hz

Dimensions: 560 x 380 x 1480 mm

Weight: 99 Kg



S0349 CBR Loading Machine motorized, 50 kN capacity. Version BS - 1 mm/

Similar to model **S0348** but with a constant speed of 1 mm/min, in compliance with standard BS 1377:4 specifications. Complete with control panel, main power switch, lifting/lowering inverter and official ENAC calibration certificate. The measurement system and accessories must be ordered separately.

S0350 CBR /Marshall load frame , 50 kN capacity. ASTM Version - 2 speeds 1,27 - 50,8m/min.

The machine consists of a sturdy test frame with two columns and a swivel upper cross-head that can be adjusted by threaded bars.

Powered by a gearbox operated by a lever depending on the test speed required. Equipped with a double end-stop to halt the bottom plate automatically.

Complete with control panel, main power switch, lifting/lowering inverter, test speed selector and official ENAC calibration certificate.

The measurement system and the accessories must be ordered separately.

Maximum capacity: 50 kN

Test speeds: 1.27 mm/min. (CBR) and 50.8 mm/min. (Marshall)

Maximum vertical span: 320 mm

Upper cross-head adjustment: 460 mm

Horizontal span: 270 mm

Stroke of bottom plate: 100 mm

Power supply: 220-240 V. 50 Hz.

Dimensions: 560 x 380 x 1480 mm

Weight: 117 Kg



S0351 CBR /Marshall motor-driven press, 50 kN capacity. Version BS – two speeds 1 - 50.8 mm/min

Similar to model **S0350** but with a constant speed of 1 mm/min, in compliance with standard BS 1377:4 specifications.

Complete with control panel, main power switch, lifting/lowering inverter, test speed selector and official ENAC calibration certificate. The measurement system and accessories must be ordered separately.

**S0355 Multispeed load frame with variable speeds, 50 kN capacity.
Variable speed range between 0.1 and 63 mm/min**

The machine consists of a sturdy test frame with two columns and a swivel upper cross-head that can be adjusted by threaded bars.

Powered by a gearbox with digital electronic control via a microprocessor for selection of test speeds with a range between 0.5 and 63 mm/min.

- CBR test at speeds of 1.27 mm/min (ASTM) and 1 mm/min. (BS)
- Marshall test at 50.8 mm/min.
- Indirect tensile test for Marshall specimens
- Fast triaxial test
- Unconfined test at 0.635 mm/min.
- Duriez test at 60 mm/min.
- Hubbard Field test at 25.4 mm/min.

Equipped with a double end-stop to halt the bottom plate automatically.

Complete with control panel, main power switch, lifting/lowering inverter, potentiometer for test speed selection and official ENAC calibration certificate.

The measurement system and the accessories must be ordered separately.

Maximum capacity: 50 kN

Test speeds: adjustable between 0.1 and 63 mm/min

Maximum vertical span: 320 mm

Upper cross-head adjustment: 460 mm

Horizontal span: 270 mm

Stroke of bottom plate: 100 mm

Power supply: 220-240 V. 50 Hz

Dimensions: 560 x 380 x 1480 mm

Weight: 156 Kg

Accessories:

CBR test:

S0352 Penetration piston, surface area 195 mm².

V0007 50 kN dynamometric ring

V0025 Brake to stabilise the maximum load in the ring dial gauge.

V0016 Dial gauge, 10 x 0.01 mm

V0030 Magnetic device to attach the dial gauge.

Marshall test:

B0056 Thrust piston

V0006 30 kN dynamometric ring

V0025 Brake to stabilise the maximum load in the ring dial gauge.

B0058 Marshall clamp

V0016 Dial gauge, 10 x 0.01 mm

V0030 Magnetic device to attach the dial gauge.



Electronic measurement systems and digital displays for CBR, CBR/Marshall and Multispeed presses

These electronic systems allow the user to read the load applied in the various tests more accurately and quickly than if dynamometric rings were used.

S0350/1 Measurement system consisting of a 50 kN load cell, displacement transducer and a **H0206/PLUS** four-channel digital display of force and displacement with microprocessor. Complete with official ENAC calibration certificate.

S0350/2 Measurement system consisting of a 50 kN load cell, displacement transducer and a **H0206/1** two-channel digital display of force and displacement with microprocessor. Complete with official ENAC calibration certificate.



Digital Displays

H0206/1 Digital display:

General Characteristics

- 14-bit Microprocessor board.
- Backlit alphanumeric display with 9 mm characters.
- Two data acquisition channels for connection to force, pressure or displacement transducers.
- RS232C output for connection to a printer or computer.
- Saves data in Excel format. (*.xls)
- Measurement units available: N; daN; kN; Kg; Nm; g; Kg; bar; mbar; Mpa; atm; V; mV; mV/V; mm; μm .
- Auto calibration key (zero)
- Peak activation key.
- Data transfer key to PC or printer.
- PROETI software for test data acquisition and transfer to a PC for printing or saving.
- **Power supply:** 220V, 50/60 Hz
- **Dimensions:** 200 x 80 x 130 mm
- **Weight:** 1 Kg



H0206/PLUS Digital Force Display Module with Microprocessor UDI 16/4 PLUS

- 16-bit Microprocessor board.
- Back-lit LCD display with 240 x 128 pixel.
- Four programmable data acquisition channels for connection to force, pressure or displacement transducers
- Two RS232C outputs for connection to a printer or PC.
- Saves data in Excel format. (.xls)
- Measurement units available: N; daN; KN; Kg; Nm; g; Kg; bar; mbar; Mpa; atm; V; mV; mV/V; mm; μm .
- Menu available in 4 languages (Spanish, English, Portuguese and Italian)
- PROETI UDI16/4PLUS software for data/curve acquisition in real time.
- Choice of the specimen area to test.
- Choice of degree of load (N/s; Mpa/s; Kg/cm²*s) and tolerance \pm % of value entered
- User selectable measurement channels.
- Automatic calculation of maximum force (Fm), Load
- Unitary (Rm), Mean Degree value.
- Formatted saving of data
- Allows saved data to be uploaded to a PC in Excel format (.xls).
- **Power supply:** 220V, 50/60 Hz
- **Dimensions:** 230 x 145 x 180 mm
- **Weight:** 2 Kg



Software displays

H0208 PROETI UDI software

This software can be used to perform the test and view the characteristic test curve for load/time or load/deformation (depending on the configuration of the H0206/1 module). The curve data can be saved in Excel format. The software is supplied separately and only runs in conjunction with the H0206/1 module.



Software for CBR and Marshall tests

S0235 Marshall test
S0236 CBR test

The **DATA ACQUISITION** application is common to all tests. This application includes highly intuitive menus that allow the user to choose predefined tests and to create new tests with new control parameters that are particularly useful for research centres. The sensors are also managed with this application, which enables them to be registered, deregistered, calibrated, etc.

The software can be used to control a large number of tests simultaneously and allow them to be viewed in real time. It also has data backup capability in the event of power outage.

The **DATA ANALYSIS** application is used to study the results of direct shear, oedometer, triaxial tests, etc.

The software runs with user selection. There is a manager role for generation and definition of tests in addition to having rights to register and deregister the sensors. There is also an operator role for carrying out the tests without being able to manipulate the settings, so that all the information is kept safe.

The program also allows remote access.

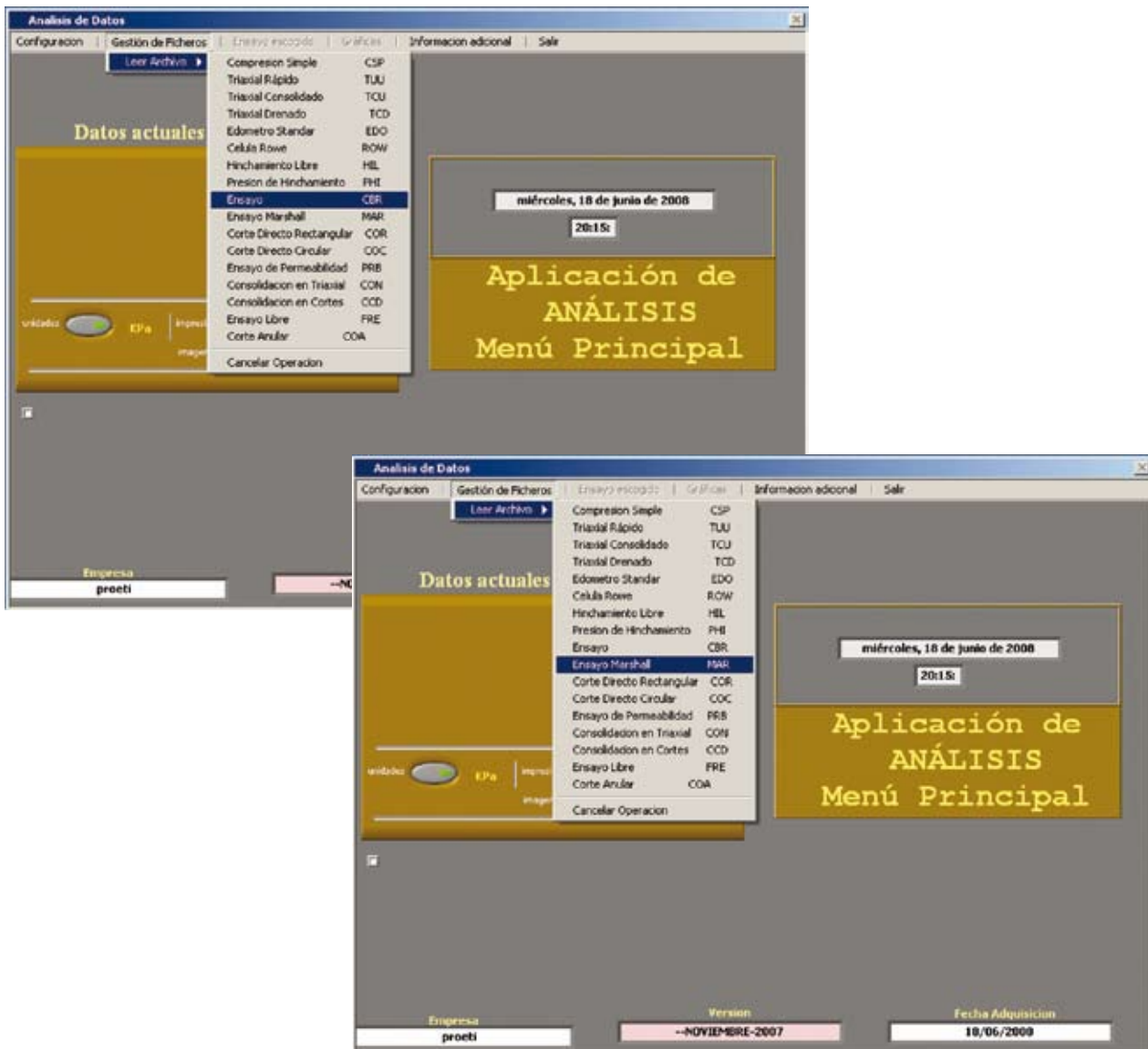

Multitester Load Frames

Compression/Bending and Tensile tests

Standards EN 13286-47; EN 196-1 UNE 103-502, 67100-85, 7035, 7060, 7090-73, 7184, 7194; NLT-111/87, 150/73, 202/72, 160/73; ASTM D1833; AASHTO T193; BS 1377:4; NF P94-078



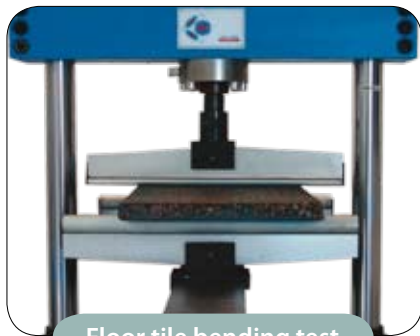

Floor tile bending test



Quick triaxial test



Roof tile bending test



Compression test for prefabricated materials

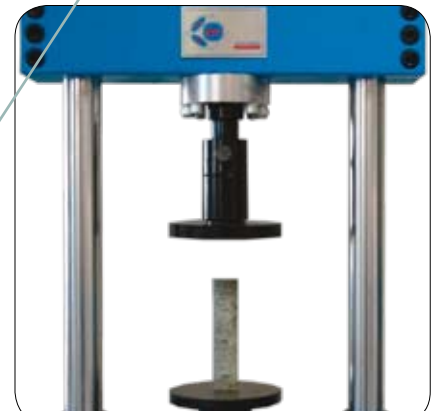

Unconfined compression test



CBR test

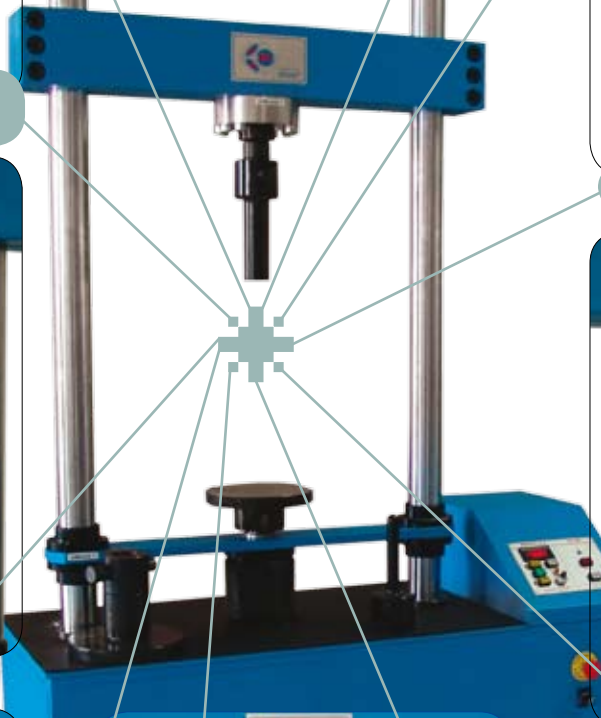

Marshall test



Cement bending test



Indirect tensile test



Cement compression test

These machines have been developed to meet the requirements of a wide range of tests; PROETI standard products offer models with 50, 100, 200 and 300 kN capacities.

Depending on their capacity and the appropriate optional accessories, these machines can perform a wide range of tests, including the following:

- Cement bending test
- Mortar compression test
- Marshall test
- CBR test
- Floor tile bending test
- Simple compression test
- 3 and 4 point bending test
- Brick bending test
- Slate bending test
- Hubbard-Field test
- Duriez test
- Metal tensile test
- Wire tensile test
- Aluminium tensile test

In general, any type of test whose characteristics allow it to be performed within the capacity and speed limits of each machine.

The multitest machines consist of the following components:

- Test frame
- Control and measurement system
- Tools (needed for each test)

Load Frame

This basically consists of a test frame equipped with a base plate, two columns, a shaft, a **mobile cross-bar** and an upper, height adjustable cross-head that is firmly attached and coupled to the columns.

The entire testing area is firmly attached to the bottom plate on a convenient, compact base unit that houses the direct current servo-motor, the gearbox, belt transmission, ball screw, stroke transducer, speed regulator and the various control and safety systems.

The force sensor or load cell is located on the top bridge or cross-head. The user can adjust the height in order to attach the various accessories needed to perform the tests (compression plate, bending device, penetration piston, etc...).

There is an incremental encoder, adapted for use with the shaft. The encoder captures the length of the stroke, either for simple display or for processing for control and definition purposes, or for test readings involving penetration, deformation and so on.



Safety systems

Given the strict safety and component protection requirements of the various international standards, our technical department has developed a double limit system consisting of **two end-stops**, one of which is at the top to protect the shaft, included in our standard equipment. The system is assembled and sealed at the factory at its maximum capacity, depending on the size of the shaft and the other components. When the preestablished limit is reached, forward motion is stopped automatically. The bottom system can be set by the user according to the requirements of the test or the dimensions of the tools and accessories that need to be used; **two force limiting devices** are also included, one at the top to protect the load cell, assembled and sealed at the factory at the maximum admissible load, and another one at the bottom that can be set by the user according to test conditions.

Control and Measurement systems

PROETI manufactures these machines in 3 different versions:



Speed control and regulation CV/PC

Digital display in mm/min. Does not include the load measuring system (dynamometric ring or load cell) which must be ordered separately.

The speed control has a digital display that shows test speeds in mm/min.

This speed can be altered by turning the "Forward Speed" potentiometer and selecting the required speed, with a maximum speed of 200 mm/min.

The CV/PC speed control model has 3 illuminated push buttons, as follows:

LIFT: moves the mobile bridge upwards.

LOWER: moves the mobile bridge downwards.

STOP: stops the movement of the machine.

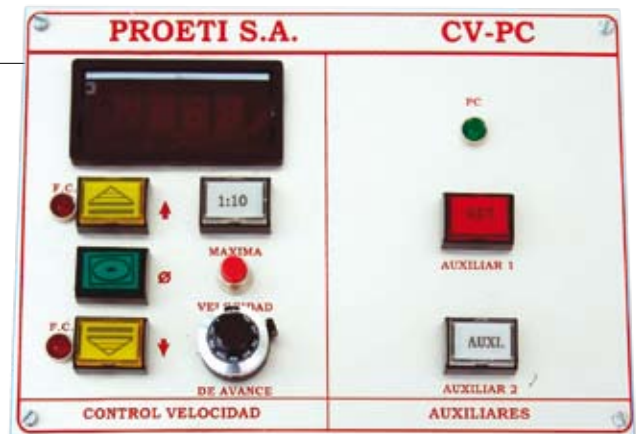

Control and adjustment of speed, force and displacement speed

Includes the H0206PLUS display with microprocessor to control load speed, that shows the maximum value at the moment of failure. Includes 4 programmable data acquisition channels, two RS232 outputs for connection to a PC or printer and Proeti UDI 16/PLUS software.



Computer control via ETIWIN software

The program has been designed for the acquisition and display of data generated during the test, as well as for the control of the multitest machine.

The system is controlled by the operator from the main computer by a series of MENUS.

The inclusion of a computer to control the analysis equipment greatly simplifies system operation, since it is exclusively dependent on interactive operator-computer dialogue by means of a conventional keyboard and a display screen.

The hardware supplied with the equipment consists of the following items:

- Computer with Windows XP Professional
 - TFT flat screen
 - Keyboard and mouse
- HP DESKJET printer

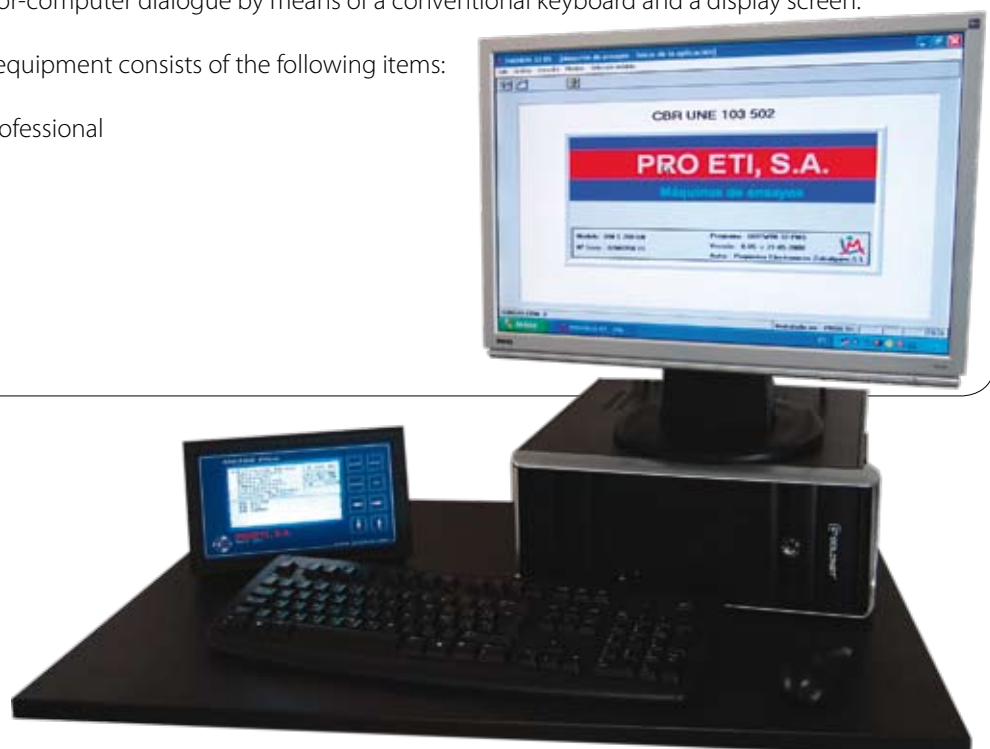



Available models:

Capacity	50 kN	100 kN	200/300 kN	200/300 kN width 620 mm
Speed control and adjustment with digital display	S0365	S0366	S0367 (200 kN)	S0367/1
Speed, force and displacement control and adjustment with digital display.	S0368	S0369	S0370 (200 kN)	S0370/1
Computer controlled	S0371	S0372	S0373 (200 kN) S0374 (300 kN)	S0373/1 S0374/1
Power	electromechanical with direct current motor			
Controlled speeds (mm/min)	0.1 – 200			
Shaft stroke (mm)	290		360	
Columns (2) diameter (mm)	50		70	
Distance between plates (mm)	610		900	
Distance between columns (mm)	420		620	
Overload capacity	150%			
Force transducer	mod. DSCK			
Linearity	0.10%			
Force precision	better than 0.5% of the reading			
Stroke transducer	incremental encoder			
Resolution	0.01 mm throughout the stroke			
Power supply	3 x 380 V 50 /60 Hz (others on request)			
Consumption	600 VA (three phase-rack)			
Height (mm)	1850		2250	2250
Width (mm)	860		1000	1200
Depth (mm)	520		520	550
Weight	300		350	380

CV/PC Electromechanical multitest load frame with digital speed selector and display

50 kN and 100/200 kN capacity

S0365 Electromechanical multitest load frame, 50 kN capacity

With the following equipment:

- 50 kN test frame, distance between columns 420 mm
- CV/PC digital speed selector and display.
- Compression plates.
- Official ENAC calibration certificate.
- Instruction manual.

S0366 Electromechanical multitest load frame, 100 kN capacity

With the following equipment:

- 100 kN test frame, distance between columns 420 mm
- CV/PC digital speed selector and display.
- Compression plates.
- Official ENAC calibration certificate.
- Instruction manual.

S0367 Electromechanical multitest load frame, 200 kN capacity

With the following equipment:

- 200 kN test frame, distance between columns 420 mm
- CV/PC digital speed selector and display.
- Compression plates.
- Official ENAC calibration certificate.
- Instruction manual.

S0367/1 Electromechanical multitest load frame, 200 kN capacity

With the following equipment:

- 200 kN test frame, distance between columns 620 mm
- CV/PC digital speed selector and display.
- Compression plates.
- Official ENAC calibration certificate.
- Instruction manual.



H0206/PLUS Electromechanical multitest load frames with digital display

50 kN and 100/200 kN capacity

S0368 Electromechanical multitest load frame, 50 kN capacity

With the following equipment:

- 50 kN test frame, distance between columns 420 mm.
- 50 kN load cell
- Digital control and adjustment of speed, force and displacement speed.
- Digital display with microprocessor **H0206/PLUS**.
- **H0208 UDI 16/PLUS** software.
- Compression plates.
- Official ENAC calibration certificate.
- Instruction manual.

S0369 Electromechanical multitest load frame, 100 kN capacity

With the following equipment:

- 100 kN test frame, distance between columns 420 mm
- 100 kN load cell
- Digital control and adjustment of speed, force and displacement speed.
- Digital display with microprocessor **H0206/PLUS**.
- **H0208 UDI 16/PLUS** software.
- Compression plates.
- Official ENAC calibration certificate.
- Instruction manual.

S0370 Electromechanical multitest load frame, 200 kN capacity

With the following equipment:

- 200 kN test frame, distance between columns 420 mm
- 200 kN load cell
- Digital control and adjustment of speed, force and displacement speed.
- Digital display with microprocessor **H0206/PLUS**.
- **H0208 UDI 16/PLUS** software.
- Compression plates.
- Official ENAC calibration certificate.
- Instruction manual.

S0370/1 Electromechanical multitest load frame, 200 kN capacity

With the following equipment:

- 200 kN test frame, distance between columns 620 mm
- 200 kN load cell
- Digital control and adjustment of speed, force and displacement speed.
- Digital display with microprocessor **H0206/PLUS**.
- **H0208 UDI 16/PLUS** software.
- Compression plates.
- Official ENAC calibration certificate.
- Instruction manual.



Computer-controlled electromechanical multitester load frames

50, 100, 200 and 300 kN capacity

S0371 Electromechanical multitest load frame, 50 kN capacity

With the following equipment:

- 50 kN test frame, distance between columns 420 mm
- 50 kN load cell
- Digital computer control and adjustment of speed, force and displacement.
- Complete PC and printer.
- ETIWIN software
- Compression plates.
- Official ENAC calibration certificate.
- Instruction manual.



S0372 Electromechanical multitest load frame, 100 kN capacity

With the following equipment:

- 100 kN test frame, distance between columns 420 mm
- 100 kN load cell
- Digital computer control and adjustment of speed, force and displacement.
- Complete PC and printer.
- ETIWIN software
- Compression plates.
- Official ENAC calibration certificate.
- Instruction manual.

S0373 Electromechanical multitest load frame, 200 kN capacity

With the following equipment:

- 200 kN test frame, distance between columns 420 mm
- 200 kN load cell
- Digital computer control and adjustment of speed, force and displacement.
- Complete PC and printer.
- ETIWIN software
- Compression plates.
- Official ENAC calibration certificate.
- Instruction manual.

S0373/1 Electromechanical multitest load frame, 200 kN capacity

With the following equipment:

- 200 kN test frame, distance between columns 620 mm
- 200 kN load cell
- Digital computer control and adjustment of speed, force and displacement.
- Complete PC and printer.
- ETIWIN software
- Compression plates.
- Official ENAC calibration certificate.
- Instruction manual.

S0374 Electromechanical multitest load frame, 300 kN capacity

With the following equipment:

- 300 kN test frame, distance between columns 420 mm
- 300 kN load cell
- Digital computer control and adjustment of speed, force and displacement.
- Complete PC and printer.
- ETIWIN software
- Compression plates.
- Official ENAC calibration certificate.
- Instruction manual.

S0374/1 Electromechanical multitest load frame, 300 kN capacity

With the following equipment:

- 300 kN test frame, distance between columns 620 mm
- 300 kN load cell
- Digital computer control and adjustment of speed, force and displacement.
- Complete PC and printer.
- ETIWIN software
- Compression plates.
- Official ENAC calibration certificate.
- Instruction manual.

Measurement Systems for CV/PC Multitest Presses with Speed Control and Adjustment.

Models S0365, S0366, S0367 and S0367/1:

- V0007** 50 kN dynamometric ring
- V0008** 100 kN dynamometric ring
- V0009** 200 kN dynamometric ring
- V0028** 50 kN load cell (50 kN presses)
- V0027** 100 kN load cell (100 kN presses)
- V0026** 200 kN load cell (200 kN presses)

Accessories required for the Multitest Presses:

Standards EN 13286-47, UNE 103-502; NLT -111/87; ASTM D1883/73; AASHTO T193; BS 1377:4, 1924:2 ; NF P94-078

CBR (California Bearing Ratio) test

- S0352 Penetration piston, surface area 195 mm².
- V0016 Dial gauge, 10 x 0.01 mm
- V0030 Magnetic device to attach the dial gauge.

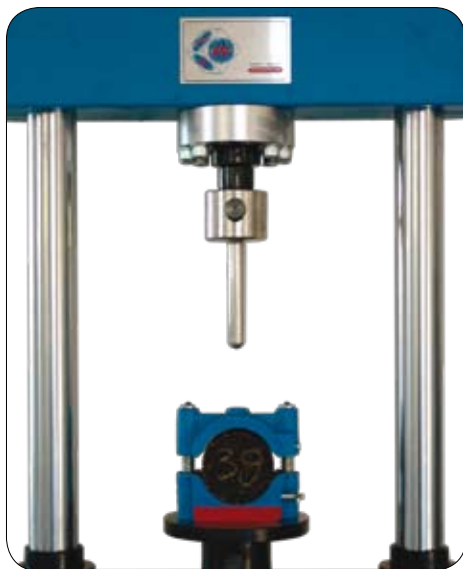

Standards EN 12697-34; ASTM D1559; BS 598; NF P98-251

Marshall stability test

- B0056 Thrust piston
- B0058 Marshall clamp
- V0016 Dial gauge, 10 x 0.01 mm
- V0030 Magnetic device to attach the dial gauge.

Standards EN 12697-23; ASTM D4123

Indirect tensile test for Marshall specimens

- B0048 Device to test indirect tensile strength of a cylindrical bituminous asphalt specimens, Ø 4" or 6". Supplied with support blades.
- H0206/PLUS Digital display with microprocessor for control and adjustment of speed and force.
- V0017 Dial gauge, 30 x 0.01 mm for diameter measurements in samples of 4" (2 units required)
- V0017 Dial gauge, 30 x 0.01 mm for axial measurements in samples of 4" (2 units required)
- V0018 Dial gauge, 50 x 0.01 mm for diameter measurements in samples of 6" (2 units required)
- V0018 Dial gauge, 50 x 0.01 mm for axial measurements in samples of 6" (2 units required)

LVDT measurement option

- S0237/1 LVDT displacement transducer, 20 mm linearity 0.25%.
- S0237/4 LVDT displacement transducer, 50 mm linearity 0.50%.
- V0030 Adjustable magnetic stand (2 units required)
- S0200 Data acquisition unit with 16 channels.
- S0235E Software for indirect tensile tests in asphalt

Note: the LVDT measurement option requires the use of a PC



Standards EN 196/1; ASTM C348

Compression and bending test in mortar specimens

C0115 Device for compression tests on mortar specimens measuring 40.1 x 40 x 160 mm

C0116 Device for bending tests on mortar specimens measuring 40.1 x 40 x 160 mm



C0116



C0115

Standards BS 1377; ASTM D2850

Fast triaxial test

S0151 Triaxial cell with accessories

Bending tests for terrazos, roof tiles, floor tiles, curbs, soil-cement specimens, clay blocks, prism specimens, natural rocks and prefabricated elements

S0381 Set of 4 bending devices and 6 sets of complete rollers, including their respective anchorings and a graduated bottom beam for perfect positioning of the rollers and for performing tests on panels, ceramic tiles, terrazos, roof tiles and large clay blocks, in compliance with the following standards:

- Terrazo bending test UNE 127.006.
- Roof tile bending test EN 538.
- Ceramic tile bending test UNE 67042.
- Ceramic tile bending test UNE 10545-4.
- Ceramic arch bending test UNE 67037.
- Laminated plaster sheet bending test UNE 102035.
- Kerb bending test UNE 127025.
- Cement tile bending test UNE 127024.
- Concrete slab bending test UNE 127023.
- Concrete and terrazo tile bending test UNE 127020

Note: The bending device can only be attached to machines with a distance between columns of 620 mm

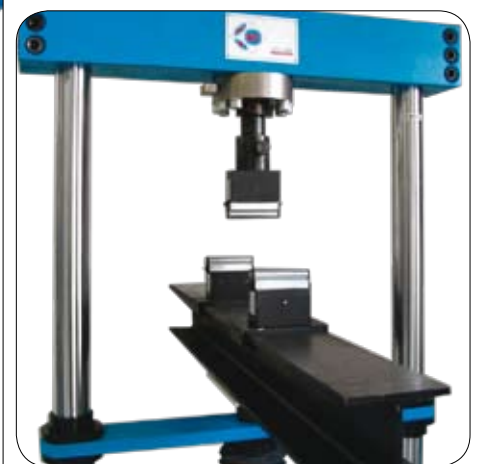

Multitest machine software

Developed under Windows, allows:

- Closed loop servo-control of force, displacement, deformation or time (ramps or functions).
- Direct control of the servo-motor (constant speed).
- Automatic selection and change in work scales.
- Detection of specimen failure with automatic shut down.
- Programming control sheets with up to 10 steps, allowing the user to preselect up to 10 speed changes or control modes during a test.

As many control files as desired can be generated from the Gestión -> fichas Control (Management -> Control files) menu item

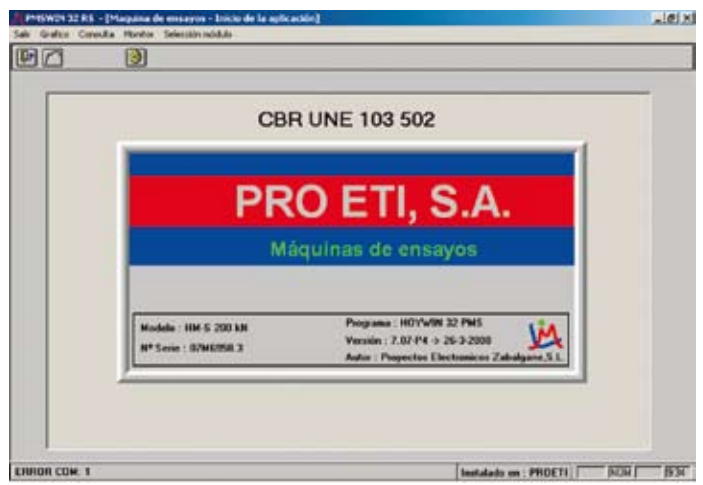
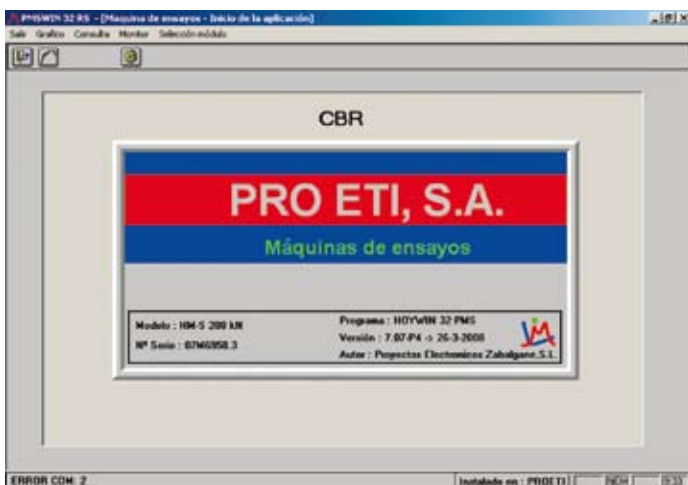
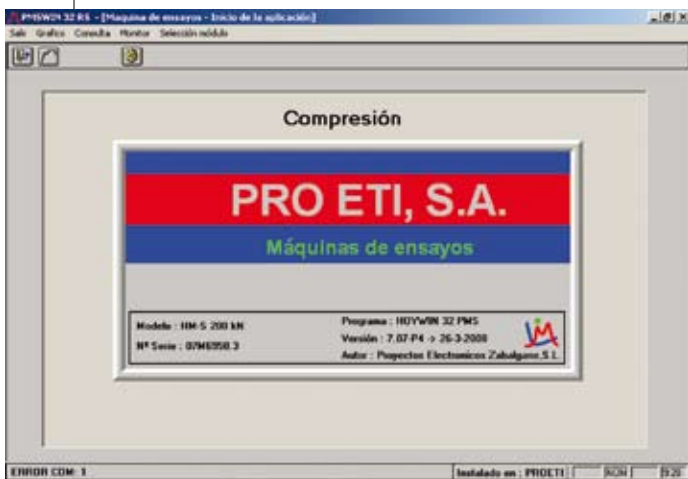

Software for Data Control and Acquisition

Data measurement and processing software allows performance of CBR, Marshall, Simple compression and CBR tests, in compliance with UNE 103502, free tests and tensile tests.

Main characteristics:

- Selection of the control files (speeds, etc)
- Selection of the specimen file with:
 - Specimen reference or name
 - Type Rectangular/Circular/Tubular/Sample
 - Lo initial length of the specimen
 - a,b/D/So section dimensions
 - n % % to calculate the Rpn, any value (0.01% 0.2 % 1%)
- Selection of the test file (Test no., material, date,... and 10 more user-defined fields)
- Graphic scale for automatic or manual tests
- Real time display in any of the available units.
 - FORCE: N, daN, kN, kp, Mp, Tonnes, etc.
 - STRENGTH: N/mm², daN/mm², kp/mm², Mpa, etc.
 - DISPLACEMENT: mm, cm, dm, m, microns, etc.
 - DEFORMATION: mm, cm, microns, etc.
 - ELONGATION: in %, per 1, etc.
 - TIME: seconds, minutes, etc.
- Simultaneous digital viewing of graphic display
- Automatic saving of X Y values of the graph in a backup file for security.
- Easy calculation and limit display features
 - Rpn (n = 0.2 % or any value entered)
 - E elastic modulus of the material
 - Rm maximum resistance.
 - A elongation
 - and other test parameters
- Data and graphics saved together in separate files.
- Data saved in Access compatible "DATABASE" files.
- Zoom option in all areas, using the mouse.
- Output of test report

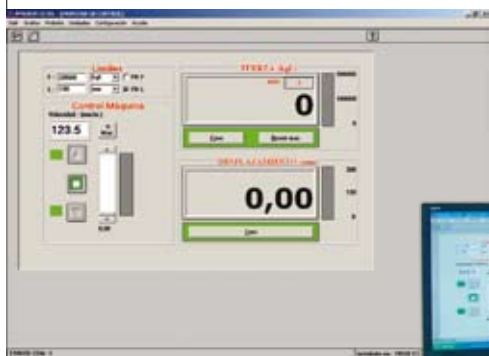
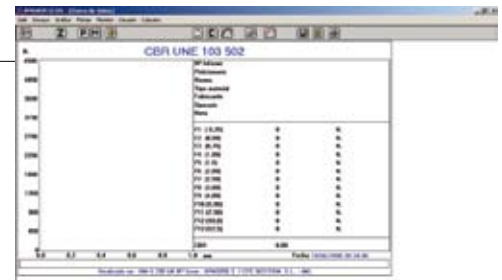

CBR tests “in situ”

Standards ASTM D4429; BS 1377

The use of the CBR “in-situ” equipment in road construction allows fast and efficient determination of soil load capacity.

S0390 CBR “in-situ” testing equipment

The equipment consists of:

S0397 Mechanical shaft, 50 kN, complete with a load application crank.

V0007 Dynamometric ring, 50 kN

S0352 CBR penetration piston

S0394 Set of extensions, consisting of:

- 51 mm long extension (2)
- 152 mm long extension (1)
- 254 mm long extension (1)
- 356 mm long extension (1)
- 457 mm long extension (1)
- 610 mm long extension (1)

S0395 Support beam, 1.20 m long

V0030 Adjustable magnetic stand.

V0017 Dial gauge, 30 x 0.01 mm stroke

S0398 Carrying case.

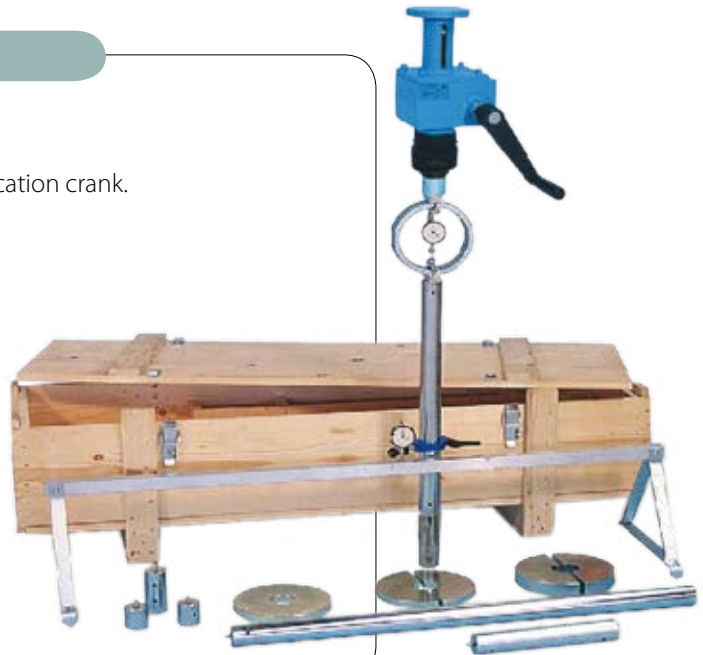

Impact test method

Used to obtain an indication of the degree of terrain compaction. The results can be directly linked to the results of the CBR test. The equipment consists of a hammer weighing 4.5 - 2.5 or 0.5 Kg, depending on the type of soil, to which is attached an accelerometer whose signal is viewed on a digital display.

S0400 Electronic compaction measuring device. As described, with a hammer weighing 4.5 Kg

Dimensions: 140 x 140 x 700 mm

S0401 Electronic compaction measuring device. As described, with a hammer weighing 2.5 Kg

Dimensions: 140 x 140 x 700 mm

S0402 Electronic compaction measuring device. As described, with a hammer weighing 0.5 Kg

Dimensions: 140 x 140 x 700 mm

Standards ASTM D1883; AASHTO T193; BS1377,1924; LCPC

S0405 Conversion frame for the CBR test in a laboratory.

Consisting of a sturdy steel frame on which is installed the mechanical shaft, the dynamometric ring and penetration piston.

This permits the operator to perform the CBR test manually, with the sample in its own mould. Supplied with:

- Test Frame
- Hand-operated mechanical jack.
- 2 kN dynamometric ring
- Compression plates.
- Dial gauge, 10 x 0.01 mm
- Dial gauge stand

Dimensions: 380 x 460 x 1380 mm

Weight: 70 Kg



Standards EN 13286-5

An indication of the compaction condition of a non-cohesive soil with free drainage can be obtained by associating its dry density with the maximum and minimum densities of the soil.

S0410 Equipment to determine relative density.

This is used in non-cohesive terrain with a minimum of 12% of particles with grain size under 0.075 mm. The equipment consists of a vibrating table, two moulds with 2.83 and 14.16 litre capacity, respectively, two adjusting hooks, two overload plates, two bases with handles and a dial gauge of 50 x 0.01 mm with a stand and calibration bar.

Table dimensions: 762 x 762 mm

Vibrating frequency: 3600 rpm

Range: 0.05 to 0.64 mm

Power supply: 3 x 220/380 V 50 Hz

Weight: 250 Kg

Accessories

S0410/1 Emptying utensil measuring 25 mm

S0410/2 Mould for relative density 0.5 cubic foot.

S0410/3 Overload and base in compliance with EN



Standards EN 13286-46; BS 1377

S0414 Apparatus to determine moisture conditions and crushing value.

Consisting of a replaceable cylinder mould, a hammer with lateral guide rails and manual fall height adjustment and an automatic hooking device. Supplied with impact counter and 6 fibre discs.

Weight: 56 Kg

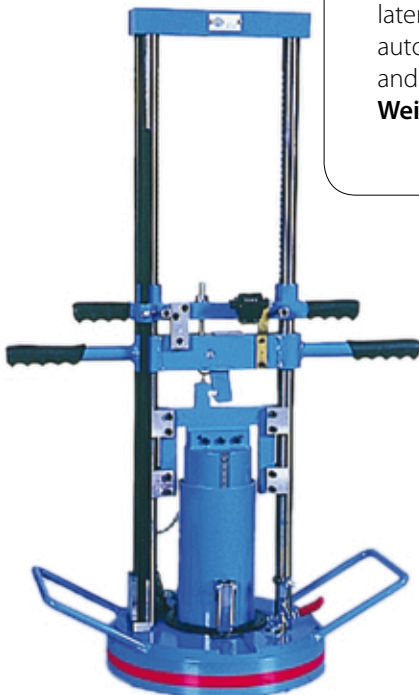

Compaction and moisture

Standards ASTM D 1558

Many civil engineering projects require the use of landfill material. When earth is used for landfill it is almost always necessary to compact it until it is dense in order to achieve satisfactory engineering properties. These properties are not obtained when the landfill is set in place loosely. Compaction "in situ" is normally performed using mechanical means such as steamrolling, impacting or vibration. Compaction must be controlled to achieve a satisfactory result at a reasonable cost.

Laboratory compaction tests provide the bases for the control procedure used "in situ".

S0417 Proctor Penetrometer

Designed to establish the ratio between moisture and penetration strength of fine granulometry terrain.

Graduated scale from 0 - 55 Kg (resolution 1 Kg)

Supplied with a carrying case and a set of interchangeable tips with the following sections: 4.52 - 5.23 - 6.40 - 9.07 - 12.83 - 16.54 - 20.22 - 24.79 28.55 mm².

Approximate weight: 3.5 Kg



S0418 Ring Penetrometer

Used to measure the shear strength of terrain. Made of steel protected against corrosion.

Supplied with a 1 kN dynamometric ring with maximum reading and a 30° angle conic point.

Approximate weight: 5 Kg



Standards ASTM D 2167; AASHTO T205 "In situ" density method of the volume meter

S0419 Membrane volume meter, capacity 1600 mL

Designed to determine "in situ" density of fine granulometry compact terrain. The device consists of a transparent cylinder graduated from 0 to 1600 mL enclosed in an aluminium casing with a carrying handle, a manual air pump, a base plate with a hole in the centre to place the device and 10 rubber membranes.

Dimensions: 700 x 360 x 340 mm

Spare parts

S0419/1 Pack of 10 rubber membranes.

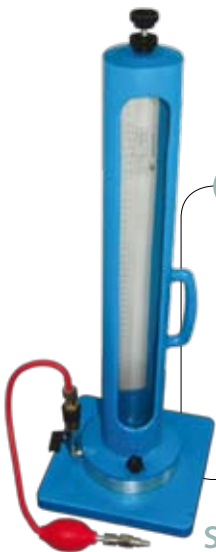

Standards NF P94-061-2

S0420 Membrane volume meter, capacity 3000 mL

Consisting of a cylinder container with carrying handle, a piston graduated from 0 to 3000 mL, a base plate with a hole in the centre, 3 anchoring rods and a set of 6 standard membranes and 6 reinforced membranes.

Dimensions: 360 x 360 x 700 mm **Weight:** 10 Kg

Spare parts

S0420/2 Pack of 6 reinforced rubber membranes.



S0421 Membrane volume meter, capacity 6000 mL

Similar to model S0420 but with a capacity of 6000 mL. **Weight:** 18 Kg

Spare parts

S0420/2 Pack of 6 reinforced membranes

“In situ” density

Standards UNE 103-503; NLT 109; ASTM D 1556; AASHTO T191; NF P94061-3

“In situ” density test using the sand method

Used to determine onsite density of fine compacted soil.
The set consists of:

- S0423 Calibrated sand (25 Kg sack)
- S0424 5 L plastic bottle
- S0425 Metal funnel, Ø 4” (102 mm), with cylinder valve
- S0426 Tray with central hole measuring Ø 4” (102 mm)
- S0427 Metal funnel, Ø 6” (152 mm), with cylinder valve
- S0428 Tray with central hole measuring Ø 6” (152 mm)
- S0429 Metal funnel, Ø 12” (305 mm), with cylinder valve
- S0430 Tray with central hole measuring Ø 12” (305 mm)



Standards BS 1377, 1924

“In situ” density test using the sand replacement method

- S0435 “In situ” density test kit for testing with the sand replacement method, Ø 100 mm
Consisting of a Ø 100 mm filling cylinder with stopper, a metal tray with a hole in the centre of Ø 100 mm and a calibration container.
- S0438 “In situ” density test kit for testing with the sand replacement method, Ø 150 mm
Consisting of a Ø 150 mm filling cylinder with stopper, a metal tray with a hole in the centre of Ø 100 mm and a calibration container.
- S0441 “In situ” density test kit for testing with the sand replacement method, Ø 200 mm
Consisting of a Ø 200 mm filling cylinder with stopper, a metal tray with a hole in the centre of Ø 100 mm and a calibration container.



Tools for “in situ” density tests

- V0037 5-litre plastic bottle
- V0034 Canvas gloves.
- V0035 Rubber gloves.
- S0447 250 mL plastic bottles
- S0448 500 mL plastic bottles
- S0449 1000 mL plastic bottles
- V0038 Rubber bucket, 12 litres.
- V0039 Rubber bucket, 18 litres.
- V0040 Canvas, 2 x 2 m to spread out samples.
- V0041 Flat brush, 5 cm wide.

- V0042 Flat chisel, 300 mm long
- V0043 Pick hammer.
- V0044 Rubber hammer.
- V0045 Flat pan.
- V0046 Small curved pan.
- V0049 Spoon.
- V0050 Ladle.
- V0051 Trowel.
- S0452 Small trowel, 60 x 140 mm
- S0453 Wooden handled pot.
- S0470 Eley volume meter

Used to determine density “in situ” of altered samples.
Made of stainless steel with a volume scale of 30 cm³



Moisture density – Nuclear method

PROETI-CPN nuclear meters provide a fast method of determining moisture content and/or density “in situ”. They have several applications, among which is compaction control of landfill material and layers of asphalt pavement and measuring moisture in structures.

Operating principle

Nuclear density/moisture meters operate by emitting radiation from a sealed safety capsule located in the measurement device. The radioactive material that is used is Caesium 137, which emits gamma rays and allows us to measure density, and Americium 241/Beryllium, which emit neutrons to measure moisture.

Proeti Services in the Nuclear Area

Proetisa has a 2nd category radioactive facility that provides all the services nowadays required by customers. The services offered by our company for CPN equipment or other brands are:



- Nuclear equipment:

- Calibration
- Leak-testing of radioactive sources
- Repair of faults in electronics and detectors
- Removal of spent radioactive sources

- Radiation monitors:

- Calibration
- Repair of faults in electronics and detectors
- Equipment sales



S0504 Monitor-4 radiation monitor

The **Monitor-4** is compact, capable of detecting alpha, beta and gamma-X ray radiation in three scales selected manually. The monitor detects ionising radiation by means of a Geiger-Mueller (GM) tube with a thin mica window.

When a beam or particle of ionising radiation hits the tube, it is detected electronically and recorded on a red counter lamp. When the switch is in the AUDIO position, the instrument also emits a sound warning for every ionising event. The normal count is 5 to 25 counts per minute at irregular intervals due to naturally occurring background radiation (depending on the location and altitude above sea level).

S0504/1 Digilert 100 radiation monitor

The **Digilert 100** is compact and capable of detecting alpha, beta and gamma - X ray radiation. Its digital display shows readings directly in counts per minute, total counts or accumulated counts, and in $\mu\text{Sv/h}$ (automatic scale). When a beam or particle of ionising radiation hits the tube, it is detected electronically and recorded on a red counter lamp. When the switch is in the AUDIO position, the instrument also emits a sound warning for every ionising event. The normal count is 5 to 25 counts per minute at irregular intervals due to naturally occurring background radiation (depending on the location and altitude above sea level).



Training course

PROETI runs training courses authorised by the CSN (National Safety Council) for Supervisors and Operators of 2nd category radioactive facilities.

- Courses for Supervisors of radioactive facilities.
- Courses for Operators of radioactive facilities.
- Courses concerning Road Transport of radioactive material.

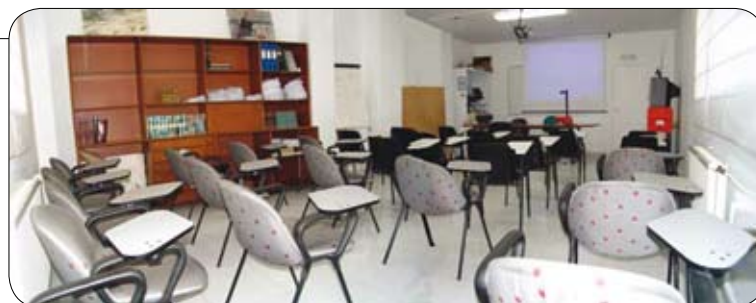

ASTM D6938-08, D2922, D2950, D3017; BS 1377

The new **MC-3 Portaprobe** is the most accurate, tough and easy-to-use device in the density and moisture measurement market.

Characteristics

- Automatic depth detection
- Light, portable and accurate
- Double position for backscatter use
- Rechargeable batteries
- Integrated microprocessor to simplify functions
- Simultaneous on-screen display of all parameters measured
- Option to selecting time and accuracy of tests
- Storage capacity for 128 complete data readings
- RS232C output to dump data to a printer or a PC
- Real time clock and calendar

Simple operation

The operator starts the test by pressing the START key... In less than a minute, the 160 character display shows all the results simultaneously. The following data appears on the screen in English or metric units:

- Wet density.
- Dry density.
- Moisture content.
- Moisture percentage.
- Compaction percentage.
- Percentage void volume.
- Statistical calculation of accuracy.

To measure pavement density, the equipment is placed on the test surface, which must be smooth and free of holes. Using the double backscatter position, accurate measurements of density can be obtained at 52.1 or 71.1 mm Measurement depth = 95% of backscattered gamma radiation. The MC-3 is used to measure layers of road surface between 25 and 76.2 mm thick, correcting for the effect of the lower layer.

To measure soil compaction, a small hole is made in the ground with a pick and the equipment is placed on the hole. The source is lowered into the hole to take density measurements with increments of 1 or 2 inches (25 or 50 mm), to a depth of 8 or 12 inches. (200 or 300 mm)

Moisture measurements are taken on the surface. Measurement depth varies between 4 and 8 inches (100 or 200 mm), without the need to make a hole or to prepare the test surface.

Accuracy

Accuracy of instrument, for one-minute tests, with 2.0 gcc wet moisture and 0.16 gcc moisture:

- * **Backscatter:** ± 0.008 gcc (± 0.50 pcf)
- * **Direct transmission:** ± 0.004 gcc (± 0.25 pcf)
- * **Moisture:** 0.004 gcc (± 0.25 pcf)



Operations

- Function:** "In situ" measurement of density and moisture
- Range:** Density 1.120 to 2.730 gcc
- Moisture:** 0 to 0.708 gcc
- Test time:** Selected by the operator.
- Operating temperature:** From 0 to 60°C (32 to 140°)
- Power supply:** 8 rechargeable Ni/Cd batteries.
- Battery life:** 500-100 charge/discharge cycles.
- Consumption:** 10 mA. Allows 600 one-minute tests.
- Recharge:** 14 hours.
- Screen:** LCD, 160 characters.
- Units:** Selected by the operator from gcc, pcf or cpm
- Storage capacity:** Up to 128 tests. Option of uploading to PC via RS232C

Radiology

- Gamma source:** 10 mCi (370 MBq) Cesium-137
- Neutron source:** 50 m Ci (1850 M Bq) Americium-241 /Be
- Encapsulation:** Sources with double encapsulation, CPN 131
- Handle dose rate:** Lower than 0.5 mR/h (5 microSv/h)
- Packaging:** Radioactive material in special form N.O.S, UN2974
- Transport index:** 0.4 Category II Yellow - A type package
- Special form certificates:** USA/0627/S, USA/0634/S

Base equipment

Supplied with a high density polyethylene case, lock and key, calibration block, base plate, pick, working slate, lubricant, signage kit and leak-tightness certificate.

Models

- S0475/MC-3-82** Portaprobe, Density/Moisture meter for tests up to 200 mm deep at increments of 50 mm
- S0476/MC-3-81** Portaprobe, Density/Moisture meter for tests up to 200 mm deep at increments of 25 mm
- S0480/MC-3-122** Portaprobe, Density/Moisture meter for tests up to 300 mm deep at increments of 50 mm
- S0481/MC-3-121** Portaprobe, Density/Moisture meter for tests up to 300 mm deep at increments of 25 mm



Density moisture–Nuclear method–MC-1-DRP

ASTM D6938-08, D2922, D2950, D3017; BS 1377

Portable equipment for fast and accurate density/moisture measurements in construction materials, for compaction control. In compliance with ASTM D6938-08, D2922 and D3017 for soil and ASTM D2950 for asphalt. The equipment directly displays the following.

- Wet density.
- Dry density.
- Moisture content.
- Moisture percentage.
- Compaction percentage.
- Percentage void volume.

Measurement of pavement density
Measurement of soil compaction
Measurement of surface moisture

Radiology:

Gamma source: 10 mCi (370 MBq) Cesium-137

Neutron source: 50 mCi (1850 MBq) Americium-241/Be

Encapsulation: Sources with double encapsulation, CPN 131

Handle dose rate: Lower than 0.5 mR/h (5 microSv/h)

Packaging: Radioactive material in special form N.O.S, UN3332

Transport index: 0.4 Category II Yellow. Type A package.

Special form certificates: USA/0627/S, USA/0634/S



Base equipment

Supplied with a high density polyethylene case, lock and key, calibration block, base plate, pick, working slate, lubricant, signage kit and leak-tightness certificate.

Models

S0485/MC-1DR-82 Portaprobe, Density/Moisture meter for tests up to 200 mm deep at increments of 50 mm

S0486/MC-1DR-81 Portaprobe, Density/Moisture meter for tests up to 200 mm deep at increments of 25 mm

S0487/MC-1DR-122 Portaprobe, Density/Moisture meter for tests up to 300 mm deep at increments of 50 mm

S0488/MC-1DR-121 Portaprobe, Density/Moisture meter for tests up to 300 mm deep at increments of 25 mm



Moisture density – Nuclear method

MC-S-24 Strata

ASTM D6938-08, D2922, D2950, D3017; BS 1377

Equipment for "in situ" measurement of density/moisture in stratified layers) to a depth of 24" (600 mm), increment of 2"

Specifications

Applications: Measurement of density/moisture in surface layers.

Test time: Selected by the operator.

Data output: RS232C to PC, printer or plotter.

Units: Operator selected, pcf, gcc and cpm

Radiology

Gamma source: 10 mCi (370 MBq) Cesium-137

Neutron source: 50 mCi (1850 MBq) Americium-241/Be

Encapsulation: Sources with double encapsulation, CPN 131

Packaging: Radioactive material ins special form N.O.S, UN3332

Transport index: 0.5 Category II Yellow. Type A package.

Special form certificates: USA/0627/S, USA/0634/S

Base equipment

Supplied with a high density polyethylene case, lock and key, calibration block, base plate, pick, working slate, lubricant, signage kit and leak-tightness certificate.

Model

S0490/MC-S-24, Surface layer density/moisture meter for tests up to 600 mm deep, increments 50 mm

Dimensions: 533 x 235 x 1016 mm

Weight: 21.2 Kg

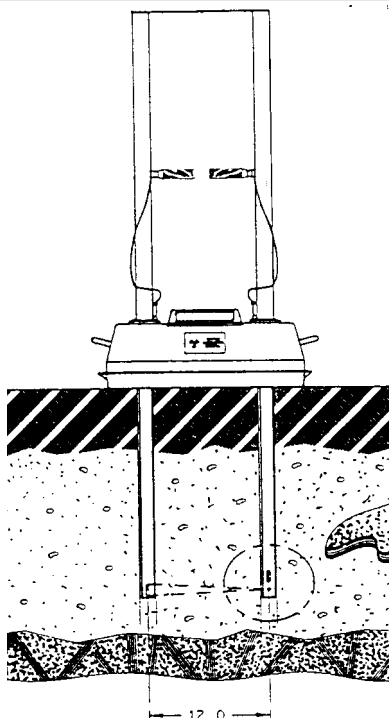

Moisture density – Nuclear method

501 – 502 – 503 DR

ASTM D6938-08, D2922, D2950, D3017; BS 1377

Subsurface density and moisture measuring equipment. The equipment is placed on the point of a probe and the probe is lowered through the access pipe to the desired measurement depth. Screen with 8 character display in engineering units, including: % moisture, pcf, gcc, inches/ft, and counts.

- Series 501 determine density and moisture.
- Series 502 determine density.
- Series 503 determine moisture.

Applications

- Civil engineering/Geotechnical
- Environmental
- Agriculture
- Mixtures
- Risk management
- Extensive farming

Radiology

Gamma source: 10 mCi (370 MBq) Cesium-137 (Mod. 501-502)

Neutron source: 50 mCi (1850 MBq) Americium-241/Be. (Mod. 501-503)

Encapsulation: Sources with double encapsulation, CPN 131

Packaging: Radioactive material in special form N.O.S, UN3332

Transport index mod. 501-502: 0,5

Transport index mod. 503: 0,2

Category II Yellow. Type A package.

Special form certificates: USA/0627/S, USA/0634/S

Base equipment

Supplied with a high density polyethylene case, lock and key, working slate, lubricant, signage kit and leak-tightness certificate.

Models

S0492 501DR, Density and moisture meter.

S0493 502DR, Density meter.

S0494 503DR, Moisture meter.

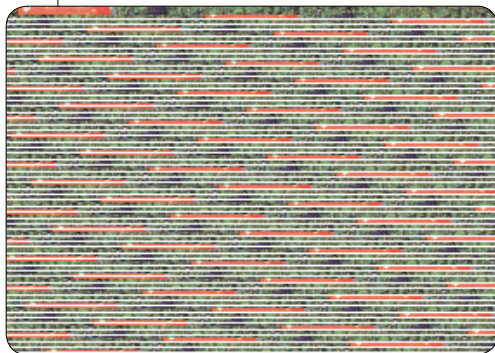

Moisture density – Nuclear method

MCM-2 Hydrotector

This is new equipment that quickly detects captive moisture and corrosion under insulation (CUI). The MC-M Hydrotector non-destructive method quickly determines moisture content in thermal insulation of piping and tanks. This equipment is ideal for application in the petrochemical industry.

The device has two modes of operation. The manual mode can be used to perform individual tests by simply pressing a button and saving the data. The fast mode performs continuous readings, one per second. It only takes a few minutes to learn how to use the equipment.

It has the capacity to save thousands of readings. The operator can format the memory to identify the location of the test, day, time and address of the measurement with an identification number.

The data can also be transferred to a computer.

Radiology

Neutron source: 50 mCi (1850 MBq) Americium-241/Be

Encapsulation: Sources with double encapsulation, CPN 131

Packaging: Radioactive material in special presentation N.O.S, UN3332

Transport index: 0.3 - Category II Yellow. Type A package.

Approved form certificates: USA/00627/S

Base equipment

Supplied with a high density polyethylene case, lock and key, calibration block, working slate, lubricant, signage kit, leak-tightness certificate and instruction manual.

Models:

S0500/MCM-2 Hydrotector.



Proetisa Nuclear Area

Accessories for nuclear equipment

- S0480/1 Battery charger for the MC-3
- S0480/2 "A" type package (MC-3/MC-1)
- S0480/3 Batteries for the MC-3
- S0480/7 Set of case labels
- S0489 Base plate
- S0489/1 Core head bit
- S0489/2 Core head bit spanner
- S0491 Calibration block



Nuclear Area courses

- S0495 Radioactive facility supervisor course (approved by the CSN)
- S0496 Radioactive facility operator course (approved by the CSN)



Radioactive facility accessories

- S0501 Radioactive facility magnetic signage.
- S0502 Magnetic danger label for vehicles, 100 x 100 mm
- S0502/1 Magnetic danger label for vehicles, 250 x 250 mm
- S0503 Danger panel for vehicles, (70/3332) 300 x 120 mm
- S0504 Monitor-4 radiation monitor
- S0504/1 Digilert 100 radiation monitor
- S0504/2 MC1K radiation monitor
- S0499 Signage kit for work areas and accidents
- S0480/9 Dose meter rados rad-60 usv



Soil permeability

Standards UNE 103-403; BS 1377:5; ASTM D2434; AASHTO T215

Soil permeability is a very important factor in the study of soil behaviour in natural conditions with regard to water flow. This mainly depends on the particle size, shape, density and degree of saturation.

S0505 Falling head permeameter



Used to determine permeability of clay and limestone terrain. The sample is introduced into the permeameter, which is connected to the pressure gauge tube filled with water. The sample must be completely saturated with water before the test, and the operator measures the water collected in the tube after having penetrating the sample.

The equipment consists of:

- A metal panel with three pressure gauge tubes measuring \varnothing 3, 4 and 6 mm respectively for the various degrees of permeability.
- A permeability cell measuring \varnothing 4" (101.6 mm) complete with a perforated base and stainless steel mesh.
- Water tanks with valve
- Tubes and connections

Weight: 18 Kg

Accessories:

- S0505/1** A permeability cell measuring \varnothing 6" (152.4 mm) complete with a perforated base and stainless steel mesh.
- S0505/2** Deaerator tank, 20 L.
- S0505/6** Water collector
- V0410** Vacuum pump
- S0506/7** Rubber tube, 3 m long

Standards UNE 103403; BS 1377

S0506 Constant head permeameter

Used to determine permeability of granular terrain, gravel and sand. The unit consists of:

S0506 Metal panel with three constant load tubes, a graduated scale and connection accessories.

Dimensions: 210 x 50 x 1160 mm

Weight: 5 Kg

Accessories

S0506/1 Constant permeability cell of \varnothing 75 mm, with three pressure points at different levels to connect the constant load tubes. Made of anodised aluminium and acrylic plexiglass.

Weight: 3 Kg

S0506/2 Constant permeability cell of \varnothing 114 mm, with six pressure points at different levels to connect the constant load tubes. Made of anodised aluminium and acrylic plexiglass. Two S0506 metal panels are needed if this cell is used.

Weight: 7 Kg

S0506/3 Constant level tank, made of plexiglass. The intake and outlet water levels can be height-adjusted.

Weight: 3 Kg



S0507 Constant and variable load combination permeameter, with four places

This apparatus is designed for constant and variable load permeability tests in compact granular soils. The device consists of a painted support bench with tubes, valves, connection pipe and height-adjustable water tank. The equipment accepts 4" and 6" diameter cells that must be ordered separately.

Dimensions: 1100 x 700 x 2200 mm

Weight: 90 Kg

S0508 Constant and variable load combination permeameter, with 6 places

This apparatus is designed for constant and variable load permeability tests in compact granular soils. The device consists of a painted support bench with tubes, valves, connection pipe and height-adjustable water tank.

The equipment accepts 4" and 6" diameter cells that must be ordered separately.

Dimensions: 1600 x 700 x 2300 mm

Weight: 120 Kg

Accessories

S0509 Cell, Ø 4" made of steel.

S0510 Cell, Ø 6" made of steel.

S0511 Porous stones, Ø 100 mm

S0512 Porous stones, Ø 150 mm



S0514 Plastic permeameter

Designed for fast determination of permeability to observe the quicksand phenomenon. Made of transparent plastic for ideal observation of soil and water flow during the test. The Ø 63 mm cell accepts samples up to 254 mm high. A graduated scale and capillary tube are supplied with the cell. Supplied with all the necessary tubing, as well as water intake and outlet connections.

Weight: 2 Kg



Erosionability

Clayish soil containing a large percentage of sodium can be highly vulnerable to erosion by water. These scattered clay soils can form cracks that cause failures in foundations and earthen dykes.

Standards NLT 207/98; ASTM D4647; BS 1377

S0515 Pinhole apparatus for scatter test

Equipment designed to identify clay soils that can be scattered by water.

Panel dimensions: 70 x 125 mm



Standards EN 933-9; NLT -171/86; NF P18-592

Methylene blue test

This test determines the presence of clays in fine materials used in road construction. The method is based on the absorption properties of clay soils and the subsequent decolouring effect on methylene blue aqueous solutions.

Methylene blue test equipment, consisting of:

V7553 Burette, with 100 mL glass stopcock.

A0552 Box of filter paper, Ø 125 mm.

A0553 Glass rod

V0135 Magnetic heated stirrer

V6804 Beaker, 250 mL.

A0555 Methylene blue (25 g)

S0525 Laboratory centrifuge, 5000 rpm

V0191 Stand

V0269 Clamp



S0527 Baroid scale

A simple and accurate method to determine mud density. A calibrated vessel with a cover and an arm graduated in grams x cm³ from 0.8 to 2.8 g/cc with a sliding weight for taking density measurements that are read once the scale has been levelled.



S0528 Marsh Cone

Used to determine mud and sludge viscosity. Made of strong plastic and supplied with a 1-litre container.

Dimensions: Ø 160 x 370 mm

Weight: 500 g

S0529 Equipment for the mix test

Portable field unit designed to measure mix characteristics. This Kit can be used to measure: viscosity, specific gravity/density, pH and sand content.

The equipment consists of:

- Baroid Scale
- Baroid Kit.
- Marsh cone for mud measuring Ø 4mm, and a 1-litre container.
- pH paper
- Stop watch
- Carrying case.



S0529/1 Baroid Kit

A fast, accurate and inexpensive method to determine the sand content in mud.

S0529/6 Baroid mud pressure filter

The low pressure filter is the most effective way to determine the filtration characteristics of perforated sludge and cement mixes. The equipment consists of a tank mounted on a frame, a pressure source, a filtering medium and a graduated measuring flask that collects the filtered liquid.

Operating pressure, 100 psi

Filtering surface area: 45.8 cm²

The basic equipment includes:

Cell made of anodised aluminium

Screens and seals

Graduated measuring flask for 25 mL

Box of 100 units of filter paper

Box of 10 nitrogen cartridges.



S0530 Pocket Penetrometer with dial

Designed for surface tests in hard and semi-smooth soil. Made of stainless steel, supplied with a case, set of 5 interchangeable tips measuring \varnothing 6.4 - 10 - 15 - 20 and 25 mm, depending on the type of soil, conversion chart and instruction manual.

Measurement range: 0 - 11 Kg/cm²

Weight: 400 g



S0531 Pocket Penetrometer

Used to determine terrain penetration resistance. Equipped with a fixed tip measuring \varnothing 6.2 mm and graduated reading scale in Kg/cm².

Measurement range: 0 - 4.5 Kg/cm²

Weight: 300 g



S0532 Pocket Penetrometer

Similar to the previous model, but with a measurement range of 0 - 16 Kg/cm²



S0535 Vane Test apparatus, ASTM D2573

To determine shear strength of cohesive, undrained terrain. Made of stainless steel. Supplied with three cross-shaped vanes measuring \varnothing 16 x 32 mm; 20 x 40 mm and 25.4 x 50.8 mm and carrying case.

Measurement range: 0 - 240 kPa

Weight: 900 g



S0538 Torvane shear tester

Designed to quickly determine shear strength of cohesive terrain.
 Supplied with three vanes.
 Measurement range: 0 - 0.2; 0 - 1; 0 - 2.5 Kg/cm²

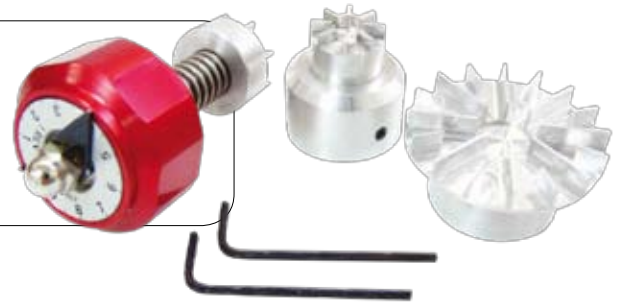
Standards ASTM D2573; BS 1377
S0539 Vane Test in situ

The field shear test is the most common test for “in situ” measurement of shear sensitivity and strength without draining of soft clay.

Technical characteristics:

Bottom part

Total length with the vane extended: 1430 mm

Maximum external diameter: 77 mm

Weight: 15 Kg

Instrument

Maximum external diameter: 320 mm

Weight including the instrument box: 16 Kg

Supplied with:

- Complete measuring instrument .
- Bottom probe unit, with vanes.
- Set of vanes and protection tube.
- 30 tubes and stems.
- Complete pre-probe equipment.
- Rack and pinion jack for insertion/extraction, complete with ball pressure cone, anchoring screws, etc.
- Metal carrying cases.

Unconfined compression test

Standards ASTM DZ166; BS 1377; AASHTO T208
S0543 Autographic device for non-confined simple compression tests

Used for rapid “in-situ” determination of shear strength with free lateral expansion. The specimen is placed between two plates and the load is applied onto a calibrated spring by means of a hand-operated shaft. A mobile arm equipped with a pen nib rotates on the lower plate, drawing a force/tension curve on a chart placed on the front of the device.

The equipment is designed to test samples of up to Ø 38 x 80 mm. Supplied with compression plates, a set of springs calibrated at 2 - 4 - 8 and 16 N, transparent dial gauge to determine force, 100 recording paper charts and a carrying case.

Dimensions: 420 x 420 x 920 mm

Weight: 15 Kg

Spare parts
S0543/1 Pack of 100 sheets for recording

S0543/2 Set of 4 calibrated springs

Plate bearing test

Standards UNE 103308, 7391

This test is used to determine the load capacity of soils for road construction. The test is performed by placing the plate on the terrain to be tested and applying a predetermined load on the plate by means of a hydraulic press.

The equipment is manufactured in two versions, 100 and 200 kN and features light weight, fast installation and operation and the option to control the load at a distance via a pressure gauge connected to the pump, as well as immediate verification of uneven plate penetration.

S0545 Load bearing plate, 100 kN capacity

The equipment consists of:

- 700 cm² plate.
- Hydraulic jack, 100 kN, with manual pump.
- Quick connector hose and connections.
- Pressure gauge with maximum reading of 100 kN
- Extendable tripod and 200 and 500 mm extensions
- Swivel joint with stand couplings.
- 3 magnetic support bases with supports for a dial gauge.
- 3 dial gauges, 30 x 0.01 mm
- Stop watch
- 2 wooden cases

Accessories

S0546/5 Plate, 762 mm diameter

S0545/UME Electronic instruments for 100 kN plate load
100 kN load cell, CB format, made of stainless steel with load plate connections and coupling elements. (V0027)

Digital force display with microprocessor (H0206/1)

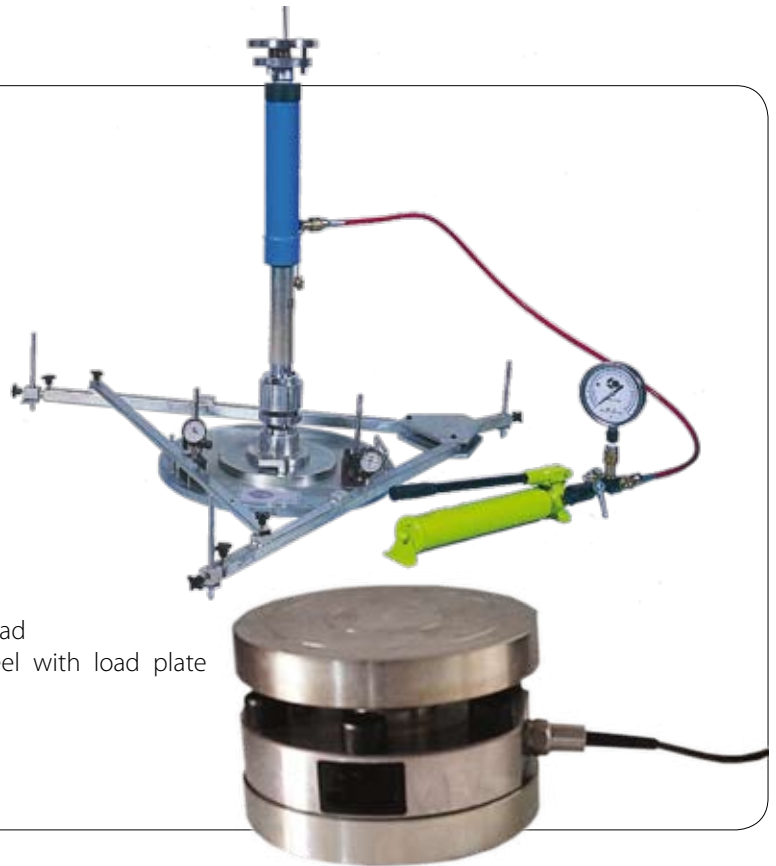

S0546 Load bearing plate, 200 kN capacity

Supplied with the same equipment as the model above and including:

- Hydraulic jack and connections for 200 kN
- Plate, Ø 600 mm, with handle.
- Square plate, 30 x 30 cm.
- Pressure gauge with maximum reading of 200 kN

Basic equipment

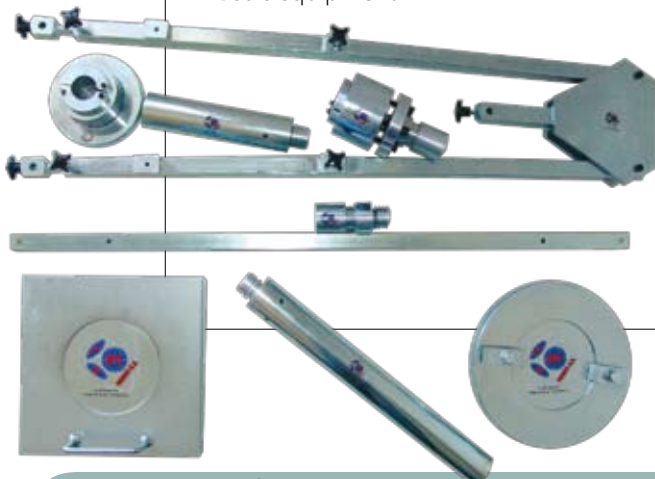

Accessories

S0546/5 Plate, 762 mm diameter

S0546/UME Electronic instruments for 200 kN plate load
200 kN load cell, CB format, made of stainless steel with load plate connections and coupling elements. (V0026/1)

Digital force display with microprocessor (H0206/1)

S0547 Load plate, 600 kN capacity

Supplied with the same equipment as the model above and including:

- Hydraulic jack and connections for 600 kN
- Plate, Ø 600 mm, with handle.
- Square plate, 30 x 30 cm.
- Pressure gauge with maximum reading of 600 kN

Accessories

S0546/5 Plate, 762 mm diameter

S0547/UME Electronic instrumentation for 600 kN plate load, including: 600 kN load cell, CB format, made of stainless steel with load plate connections and coupling elements. (**V0026/0**)

Digital force display with microprocessor (**H0206/1**)



S0546D Load plate, 200 kN capacity

Supplied with the same equipment as the model above, except for the pressure gauge which is digital

Standards UNE 103 807

S0544 Dynamic load plate test.

A light piece of equipment for dynamic load plate tests for onsite determination of the dynamic deformation modulus of compact layers in embankments and granular bases. This test is almost instantaneous and avoids the use of trucks or other heavy elements for reaction.

Unlike the other equipment, it includes a force transducer, allowing for changes in weights, fall height and plate diameters. This means that it can be used to determine a wider range of moduli than other equipment.

The results are uploaded directly to a laptop or wireless PDA.

The accessories include as many as three geophones to determine moduli of deep layers. Easy to transport from one test location to another by means of the Trolley system.

Another accessory that can be incorporated into the equipment is a GPS, for geo-locating all the readings. This data can later be transferred to digital maps.

This is the only equipment that directly determines the modulus without applying correction factors.

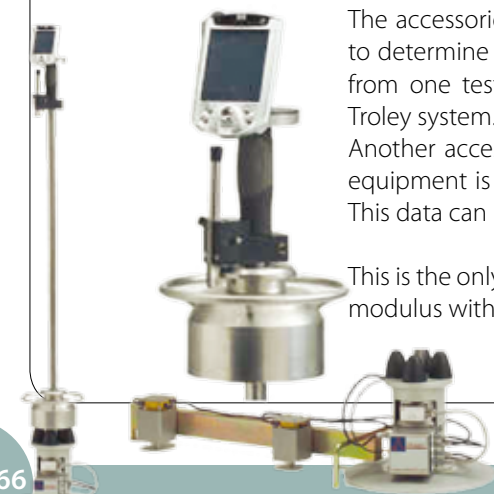

Dynamic penetration test

Standards UNE 7308; ASTM D3550, D1587; NI-ISSMFE

The dynamic penetration test is specifically designed for investigating high penetration resistance terrain.

It can be used to determine the thickness of various layers of soil and therefore useful for road construction, compaction control and to measure the relative density of terrain with low cohesion.

The test consists of measuring the terrain resistance to probing, performed using a conic standard dimension test probe. The test probe is introduced in the soil by a percussion device.

The resistance values depend on the ratio between probe depth and the number of impacts.

S0548 Hydraulic dynamic penetrometer

Easy and convenient to transport, the apparatus is designed to be handled by a single operator.

Made in compliance with standard NI of the ISSMFE, and capable of performing the following tests:

- DPSH (DYNAMIC PROBING SUPER HEAVY).
- SPT (STANDARD PENETRATION TEST).
- BORROS

The device is connected by quick connector hoses to a unit consisting of a 5 CV gasoline motor that regulates the impact speed between 20 and 30 impacts per minute and a hydraulic power pack with 25 L capacity

It is equipped with a digital impact counter. it can be used with rods of up to 1 m long.

Supplied with wheels for easy transport.

The equipment includes a hydraulic rod remover, with 120 kN capacity, with two double effect cylinders, also equipped with quick connector hoses for easy connection.

- **Hammer weight:** 63.5 Kg
- **Free fall height** 76 cm
- **Hydraulic power pack capacity:** 25 L
- **Dimensions of the penetrometer:** Open: 1.580 mm
Closed: 2.400 mm
- **Total dimensions approx:** 1.600 x 500 x 700 mm



S0549 Hydraulic dynamic penetrometer

With similar features to the model above, except for a rubber tread autopropulsion system. Made in compliance with standard NI of the ISSMFE, able to perform the following tests:

- DPSH (DYNAMIC PROBING SUPER HEAVY).
- SPT (STANDARD PENETRATION TEST).
- BORROS

Technical characteristics:

- **Hammer weight:** 63.5 Kg
- **SPT and DPSH free fall height:** 76 cm
- **Borros fall height:** 50 mm
- **Rod dimension** 1 m
- **Diesel engine:** 10 hp
- Hydraulic powered rubber caterpillar tread
- Electronic impact counter
- Graduated ruler for penetration control
- Set of dynamometric spanners for torque control
- Oil-cooling circuit
- **Speed Gear 1:** 1-2 km/h
- **Speed Gear 2:** 2-3.5 km/h
- Rapid rod remover
- Ring remover jack, 10 TM with interlocking plate
- Tool boxes with safety lids to hold up to 20 rods and other items
- Hydraulic-powered telescopic levellers
- Guided rollers with side door
- **External chain width:** 750 mm
- **Dimensions for transport:** 1350 x 900 x 2000 mm
- **Weight:** 780 Kg



Accessories for penetration test:

- S0550 Rod, \varnothing 32 x 1000 mm long with nipple
- S0551 Blind penetration cone for DPSH.
- S0549/2 Recoverable penetration cone for DPSH
- S0549/1 Impact head
- S0548/3 Penetration cone holder
- S0548/8 Fixed spanner for tightening the rod
- S0548/6 SPT 2" split spoon with valve
- S0548/7 50M-32M reduction

S0552 Hand-operated light dynamic penetrometer

Used to determine the relative density of non-cohesive soil. The equipment can be used in tests to a depth between 8 and 12 meters.

The equipment includes the following components:

- 10 Kg hammer with 500 mm fall height
- 11 rods, \varnothing 22 mm x 1 m
- Rod remover
- 2 penetration cones of 90° measuring 2 and 10 cm², respectively
- Guiding rod
- Transport case

Dimensions: 1080 x 220 x 360 mm

Weight: 71 Kg



S0553 Motor-driven dynamic penetrometer, DPM 30-20

Designed to measure resistance of terrain to a probe, performed with a standard measurement conic test probe.

The test probe is introduced into the terrain by a percussion system. The resistance values depend on the ratio between probe depth and the number of impacts needed to obtain it.

Designed for transportation by a single operator.

Supplied with the following components:

- Hydraulic penetration system, with a 30 Kg hammer and 20 cm fall height.
- 3.5 Hp petrol engine.
- Distribution pedal.
- 10 penetration rods average $\varnothing 20 \times 1000$ mm M12
- 50 blind penetration cones $A=10 \text{ cm}^2$; $\varnothing 35.6$ mm cone= 60°
- 2 impact heads.
- 2 penetration cone holder.
- 5-tonne hydraulic extractor.
- Rod mp.

Accessories and spare parts:

- S0553/1** Disposable penetration cone, 60°
- S0553/2** Recoverable penetration cone
- S0553/3** Penetration rod, $\varnothing 20 \times 1000$ mm
- S0553/4** Impact head
- S0553/5** Penetration cone holder

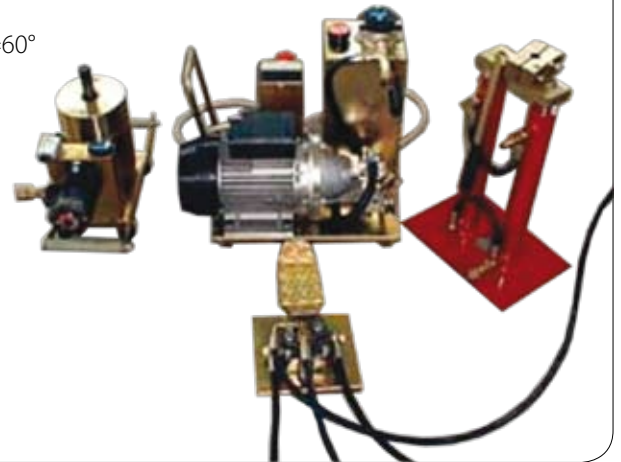

Water level probes

For rapid, easy and accurate determination of the water level in probes.

Reading is directly displayed in the graduated cable.

- 10 mm wide polyethylene tape with side reinforcement.
- Signal: visual or sound.
- Marked every 10 cm in black and metres in red.
- Light manual drum for 15 to 50 m length of cable.
- Probe: $\varnothing 15 \times 140$ mm long, with cable exit protection.
- Electronics: transistorised, housed in the drum.
- Power supply: 4 1.5 V batteries

Models

- S0561** Water level probe with 30 m cable
- S0562** Water level probe with 50 m cable
- S0563** Water level probe with 80 m cable
- S0564** Water level probe with 100 m cable



6

BITUMENS

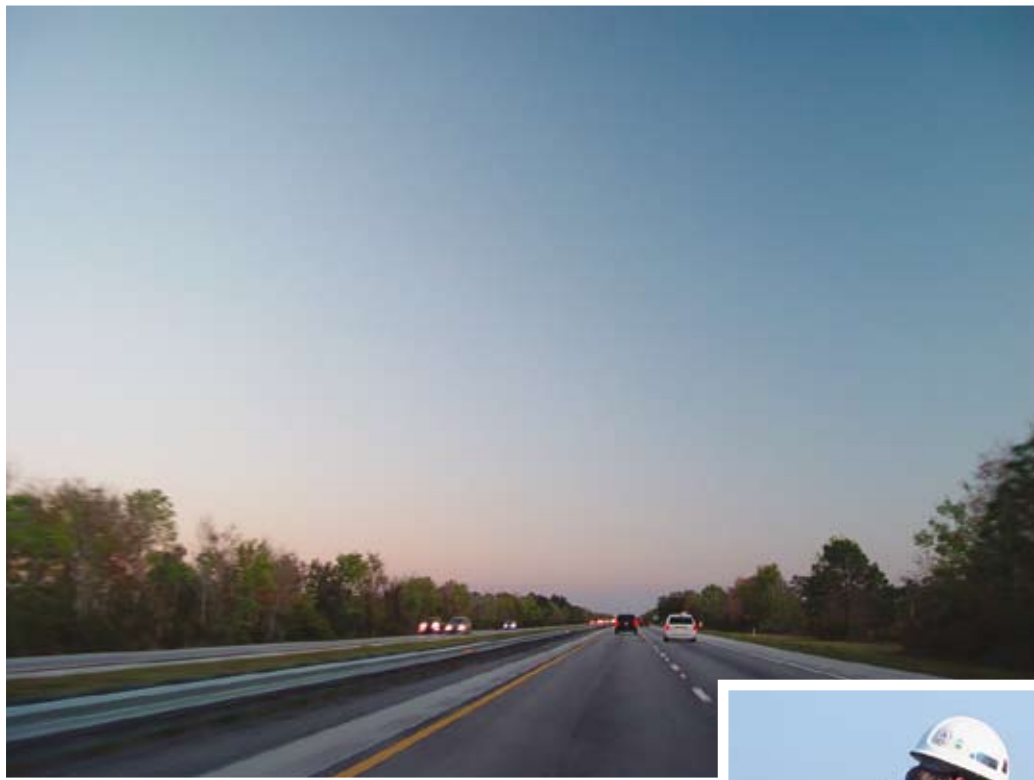

Analysis of bitumen samples

Standards UNE EN 12697-1; BS 598, 5284

Bitumen materials are most commonly used in road construction. This material basically consists of two ingredients, aggregate and a binder.

The term asphalt is simply one of two generic names used to classify or describe bitumen mixtures.

The analysis of bitumen mixtures is essential to ensure compliance with specifications, profitability and control of production. There are several test methods and the most common are described briefly together with the apparatus required to determine the binder content and the classification of aggregates.

Extraction bottle method

This method is used to extract the binder so it can be tested against requirements, either directly or by comparison.

B0001 Bottle shaker.

A bottle shaking machine consisting of a compact bench designed to rotate three bottles simultaneously on their longitudinal axes. The machine is of robust construction and takes 500 mL bottles, with rotation speeds between 0 and 60 rpm.

Power supply: 230 V 50 Hz 1 ph

Dimensions: 385 x 295 x 160 mm

Weight: 10 kg

Accessories:

B0001/1 500 mL glass bottle (borosilicate), 86 mm diameter, 176 mm high, 34 mm neck diameter, in accordance with EN specifications.

B0001/2 Glass rod 6 mm thick with rubber tip (35 mm)



Bitumen measuring instruments

These are used to determine the percentage of bitumen and aggregate in asphalt mixtures without extraction, returning previously established results for the specific gravity values of the bitumen, aggregate and solvents.

B0003 Bitumen measuring instrument, capacity 750 mL

B0004 Bitumen measuring instrument, capacity 1500 mL

Pressure filter method

Standards UNE EN 12697-1; BS 598

B0007 Pressure filter

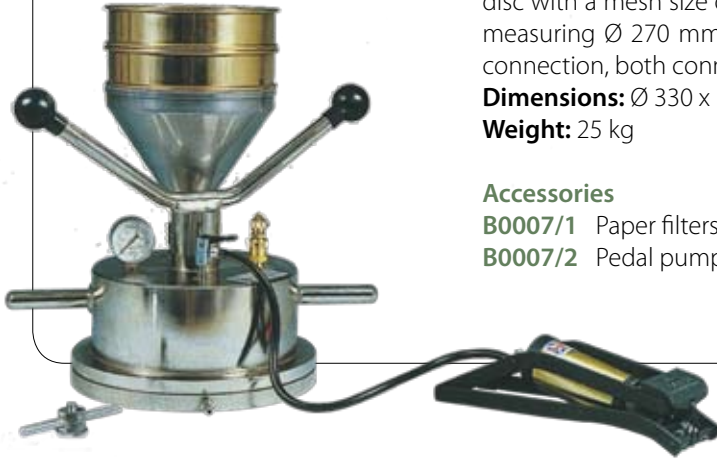

This filter is used to separate the filler from the solvent solution. It consists of a cylindrical container closed at the bottom by a drilled metal disc that holds another disc with a mesh size of 0.074 mm and a round Whatman No. 5 paper filter, both measuring \varnothing 270 mm. The upper part has a manometer and a compressed air connection, both connected to the drilled disc at the bottom.

Dimensions: \varnothing 330 x 120 mm

Weight: 25 kg

Accessories

B0007/1 Paper filters, box 100 units.

B0007/2 Pedal pump, complete with a rubber hose and standard connections.

Standards UNE EN 12697-1; DIN 1996

Hot extraction method



B0010 Hot extraction device, designed to separate the bituminous binder used in the preparation of the compound from fine and coarse aggregate used in the preparation of the mixture.

The device is made up of a 5 L pyrex glass container, a stainless steel basket with mesh size 0.063 mm and capacity for 400 g of compound, and a cover with water circulation to cool the solvent.

Dimensions: \varnothing 160 x 335 mm

Weight: 5 kg

Accessories:

B0010/1 Heating plate, \varnothing 185 mm

V0208 Metal fabric with ceramic fibres, 160 x 160 mm

Spare parts:

B0010/2 Stainless steel basket, mesh size of 0.063 mm

B0010/3 Glass container



Standards UNE EN 12697-1, 12697-14; NLT -137; BS 598
B0011 Hot extraction device

Designed to extract bitumen from asphalt. The device consists of a flanged stainless steel beaker (complete with O-ring and cover), a basket with 2 mm mesh, a 12.5 L Dean Stark tank, a Liebig condenser and a box of 100 Ø 400 mm filters.

Weight: 25 kg

Dimensions: 490 x 480 x 900 mm

Accessories:

B0010/1 Heating plate, Ø 185 mm

Spares

B0011/1 Box of Whatman No. 54 paper filters, Ø 400 mm (100 units). Ceramic fibre, 160 x 160 mm

Standards UNE EN 12697-5, 12697-12; ASTM D 2041
B0014 Yale pycnometer

To determine the maximum theoretical specific weight of bituminous mixtures. It consists of a transparent plexiglass vessel with room for three samples weighing 6 kg. Supplied complete with manometer and valve.

Capacity: 10 litres

Dimensions: Ø 300 x 450 mm

Accessories:

V0410 Portable vacuum pump. The pump is supplied complete with a regulator, water condensation collector and 3 m connection hose.

B0013 Electromagnetic vibrating deaerator with vibration intensity control. Designed to make the pycnometer vibrate for easier air removal.

B0013/1 Tube to connect pycnometer to vibrating deaerator.

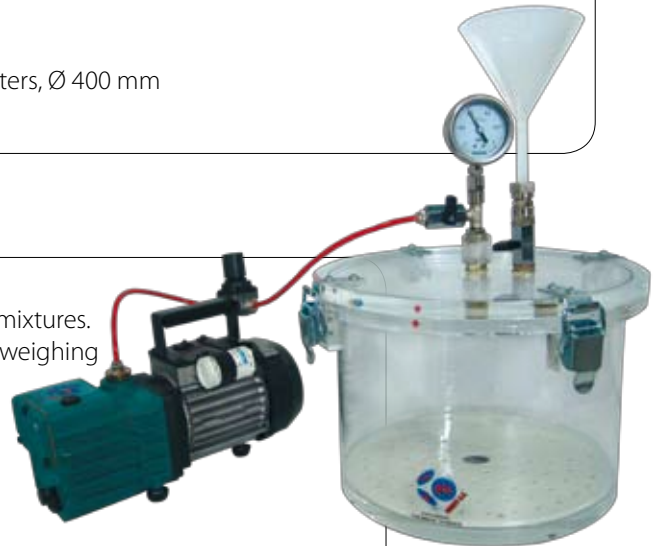
Standards UNE EN 12607-3, 12697-3; NTL 347
B0015 Thin film rotating evaporator

The binder is separated from the sample by dissolving it in dichloromethane. The undissolved solids are separated by centrifuging or filtering prior to recovering the binder by vacuum distillation, using the thin layer rotating evaporator. The apparatus consists of a glass device that includes a condenser, receiver flask, 1L evaporator flask, oil bath with thermostat, motor and vacuum generator.

Power supply: 220 V 50 Hz



Quantitative extraction

Standards UNE EN 12697-1; NLT 164; ASTM D2172; AASHTO T164

Both ASTM and AASHTO specify various methods for the recovery of bitumen from bituminous mixtures. The bitumen is extracted using specific solvents and the content is calculated by comparison.

B0020 Centrifuge extracting machine with capacity for 3000 g

Designed to determine the filler content in bituminous compounds. Built out of steel plate, with four rubber legs to absorb the vibrations from unbalanced loads. The electric motor and control electronics are incorporated in the structure of the machine.

The motor shaft rotates the unit consisting of the plate, filter and centrifuge lid. The discharge is through the hose located at the bottom of the hood. The control panel contains the main ON/OFF switch, a potentiometer to control the speed, the start/stop and brake buttons.

Plate capacity: 3000 g

Power supply: 220 V 50/60 Hz

Dimensions: 540 x 400 x 540 mm

Weight: 35 kg

Accessories and Spare Parts

- B0020/1** Filter paper, pack of 250 units
- B0020/2** Cover and plate, capacity 3000 g
- B0022** Package with 25 L of trichloroethylene
- B0023** Drum with 200 L of trichloroethylene
- B0020/5** Electromagnetic safety microswitch



B0021 Centrifuge extracting machine with 1500 g capacity

Designed to determine the filler content in bituminous compounds.

This model is similar to the **B0020** centrifuge but the container plate has smaller capacity.

Plate capacity: 1500 g

Power supply: 220 V 50/60 Hz

Dimensions: 540 x 400 x 540 mm

Weight: 32 kg

Accessories and Spare Parts

- B0021/1** Filter paper, pack of 250 units
- B0021/2** Cover and plate, capacity 1500 g



Standards UNE EN 12697-1; NLT 164; DIN 196; CNR a. VII N.38.
B0024 Continuous flow centrifuge

Built of steel plate, with four rubber legs to absorb the vibrations from unbalanced loads. The main switch is located on the control panel. Supplied complete with two Ø 8" sieves made of stainless steel with mesh sizes ASTM Nos. 100 and 200, ball valve for passage of compounds and an aluminium beaker.

Characteristics:

Rotation speed: 11000 rpm

Container capacity: 400 g of filler.

Power supply: 220 V 50/60 Hz

Dimensions: 800 x 400 x 440 mm

Weight: 80 kg

Spare parts

B0024/1 Aluminium beaker, capacity 400 g of filler.

B0024/2 Sieve Ø 8" ASTM No. 100

B0024/3 Sieve Ø 8" ASTM No. 200

Standards ASTM D 2172; AASHTO T164
B0025 Reflux extractor, capacity 1000 g

Used to determine the bitumen content in aggregate bituminous mixtures (asphalt). The extractor consists of a base supporting two cones, each with a 500 g capacity, with stainless steel mesh, borosilicate heat-resistant glass beaker and water condenser with special connections for water intake and outlet. The solvent used to extract the bitumen is trichloromethane, which does not give off toxic fumes during the test. Bitumen content is calculated by comparing the initial weight of the asphalt sample and the weight of the aggregate remaining at the end of the test.

Characteristics:

Cone mesh size: square 1.25 - 1.4 mm

Beaker Dimensions: Ø 152 x 457 mm

Dimensions: Ø 180 x 490 mm

Weight: 3 kg

Accessories:

B0010/1 Heating plate, Ø 185 mm

B0025/1 Paper filters, box 50 units.

V0208 Metal fabric with ceramic fibres, 160 x 160 mm

Standards ASTM D 2172; AASHTO T164
Hot reflux extractors

B0026 Reflux extractor, capacity 5000 g Used to determine the bitumen content in aggregate bituminous mixtures (asphalt). The extractor consists of a cylindrical container with approximate capacity of 5 kg, made of stainless steel, a basket with 3 mm mesh and a water condenser cover with special connections for water intake and outlet.

Dimensions: Ø 215 x 430 mm

Weight: 6 kg

B0027 Reflux extractor, capacity 3000 g

Accessories:

B0010/1 Heating plate, Ø 185 mm



Standards EN 12697-1, EN 13108 - LCPC - CNR N.38

B0028 Kumagawa Extractor (Soxhelet) capacity 1 L

Designed to extract bitumen from mixtures. It consists of a heating blanket, a 1000 mL flask, glass connections, ball coolant and 25 filter cartridges.

Power supply: 220 V 50/60 Hz

Spares:

B0028/1 Filter cartridge Ø 58 x 170 mm (25 units)

B0029 Kumagawa Extractor (Soxhelet) capacity 2 L

Similar to **B0028** but with 2 L capacity

Spares:

B0029/1 Filter cartridge Ø 80 x 200 mm (25 units)



Centrifuging

Standards NLT 169/72

B0030 Kerosene centrifuge

Designed for general centrifuging applications, with a stainless steel 18/8 centrifuge chamber. A control panel controlled by a microprocessor, including a main switch, rpm selector/display, a timer adjustable between 0 - 60 minutes, brake button with deceleration and rapid stop options and memory entry and recovery push buttons.

Safety devices include a LED that indicates that the cover is open or not closed correctly so that the rotor cannot start; the push button to open the cover will not be enabled until the cover is completely closed; intermittent noise and light signals, with automatic rotor stop if the load is excessively unbalanced.

Rotating head complete with two cylindrical metal beakers open at the ends, measuring Ø 52.39 x 71.4 mm high, provided with drilled bronze plate.

Power supply: 220 V 50/60 Hz

Dimensions: 365 x 430 x 305 mm

Weight: 23 kg

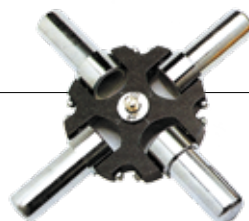

Standards UNE EN 12697-39; AASHTO T164; NLT384/00; ASTM T 308-99
B0031 Ignition oven

This NCAT asphalt content device is an analyzer that determines the asphalt content in a sample by igniting the sample. The asphalt sample is bathed in oxygenated air and weighed continuously during the ignition process. The NCAT asphalt content analyser software identifies the end point of the ignition and indicates the end of the test. A printer outputs the results.

The oven is heated to a pre-established temperature in the range 450 °C - 550 °C

The hot asphalt mix sample is weighed, divided into equal parts and placed in two reinforced baskets mounted on a tray assembly. The complete assembly is placed on the tray on the oven floor. The tray is mounted on four ceramic supporting tubes that, in turn, are placed on the platform of a digital scale. A fan pushes ambient air through the holes in the four ceramic support tubes located at the base of the chamber. This oxygenated air saturates the asphalt sample laid out to facilitate its ignition and incineration.

The volatile elements that are released are later oxidised when they pass through a ceramic filter heated to 750 °C in a chamber over the main chamber. Five exit nozzles direct the exhaust air toward a plenum chamber with shutters. There the exhaust gas is cooled by mixing it with ambient air. The fan then pushes the exhaust gases through the exhaust nozzle of the plenum chamber. A standard, one-piece exhaust pipe drives the exhaust gases to an external extraction system.

After between 20 and 40 minutes, depending on the weight of the sample, the oven detects the end of the test when all the bitumen has been incinerated and stops emitting a whistle.

A report is printed showing the percentage of bitumen per aggregate and mixture.

Power supply: 6000 W / 220 - 240 V

Width: 55 cm

Depth: 63 cm

Height: 105 cm

Accessories:

B0031/1 Heat resistant gloves

B0031/2 Thermal printing paper

B0031/3 Flexible aluminium tube, 100 x 1.5 m

B0031/4 Sample incineration cage

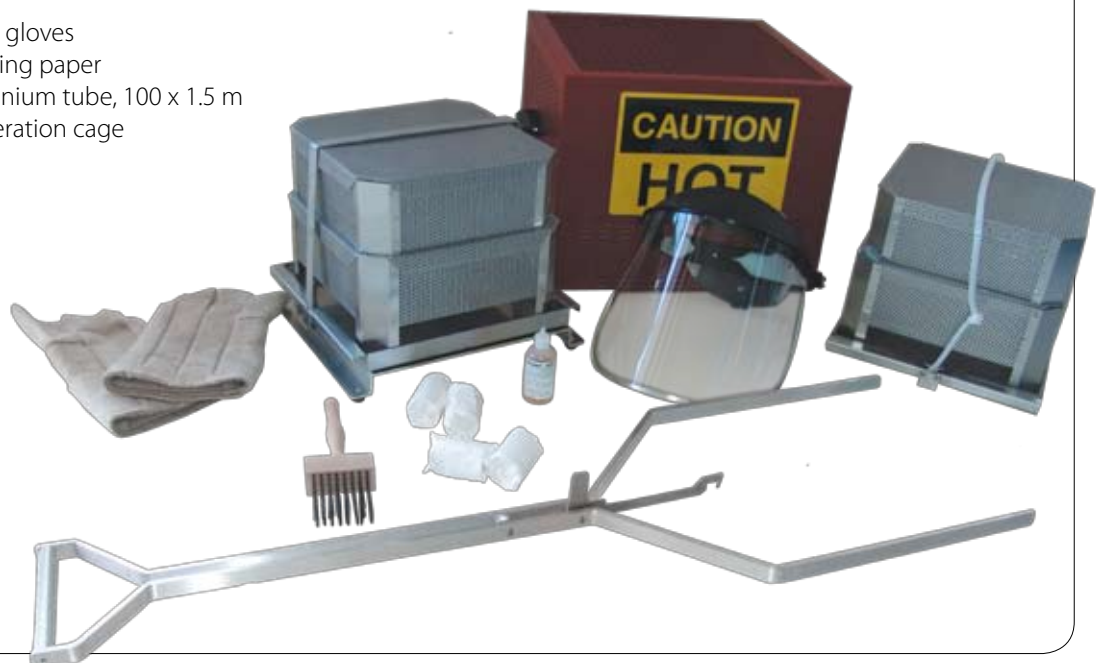

Automatic extraction

Standards UNE EN 12697-1; DIN 1996; CNR a. Vil. 38

The ever-increasing emphasis on safety, environmental contamination and automatic handling of toxic materials has led to the need to develop and use automatic bitumen extraction systems. The automatic extractor is a reliable system designed to analyse bituminous mixtures.

B0032 Automatic bitumen extractor

For fast analysis of the amount of bitumen in an asphalt specimen. This machine performs all the operations that usually require separate machines, such as an extractor, centrifuge or automatic distiller - thereby saving time and avoiding risk of operator inhaling toxic fumes.

The equipment consists of a sieving unit (adapted to hold sieves) complete with a suction nozzle and pan with a distribution bay, used to wash and separate the sample of aggregate. A continuous flow machine with three cylinders to separate the binder. A solvent distiller, complete with two tanks, one to collect the used solvent and the other for the recycled solvent. A control panel with accessories to fasten it to a wall, complete with a main switch, timer programmer for the solvent pump and for the centrifuge, sieve vibration intensity and start up buttons.

Power supply: 3 x 380 V 50 Hz 5.5 kW

Dimensions: 1400 x 610 x 1820 mm

Weight: 189 kg

Accessories

B0032/1 Extractor hood to prevent the toxic fumes from spreading.

B0032/2 Sieve, stainless steel, mesh size 0.075 mm

B0032/3 Sieve, stainless steel, mesh size 0.09 mm

B0032/4 Sieve, stainless steel, mesh size 0.15 mm

B0032/5 Sieve, stainless steel, mesh size 0.3 mm

B0032/6 Sieve, stainless steel, mesh size 0.6 mm

B0032/7 Sieve, stainless steel, mesh size 2 mm



Solvent recovery

Non-flammable solvents can be recovered with a distiller. The operation is dangerous and should be performed under strict controlled conditions. Dichloroethane and trichloroethylene are a health hazard and exposure during work should therefore be limited.

B0035 Distiller for the recovery of the solvent

The distiller has a capacity of 10 L/h, is made completely of stainless steel, is compact and easy to install, consists of two chambers, one for the dirty solvent and another for the distillate. Cooling is carried out by a cooling coil connected to the water network. The distiller has a safety device that cuts off the electrical current in the event of overheating and automatically shuts down the equipment after extraction.

Power supply: 220 V 50 Hz

Dimensions: 320 x 400 x 650 mm

Weight: 15 kg

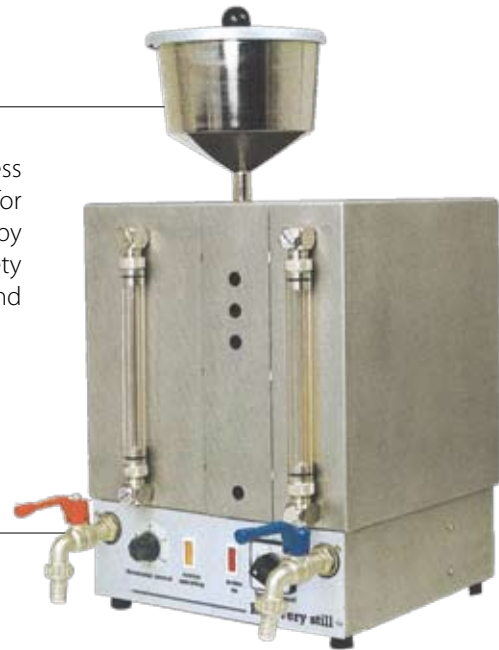

Mixing and temperature

The density of Marshall test tubes has a direct effect on stability and flow. Efficient control of the mixture, the temperature and packing are closely related. Aggregate that is poorly coated due to low temperatures during the mixing process will have a significant effect on subsequent test results.



B0038 Laboratory mixer

The mixer has a capacity of 20 L and is especially designed for the preparation of bituminous mixtures for Marshall tests or other mixtures. The stainless steel bucket is prepared for the installation of a heating system, necessary to knead the mixture while hot. Supplied complete with a speed control device, a bucket and a hook-type paddle.

Dimensions: 260 x 760 x 860 mm

Weight: 160 kg

B0038/1 Electrical blanket with temperature control.

B0038/2 Kneading paddle.

B0038/3 Spiral paddle.

Marshall compaction

Standards UNE EN 12697-10, 12697-30; NLT 159; ASTM D 1559; BS 598

Marshall manual compacting base

B0040 The Marshall manual compaction base consists of a wooden pedestal, a base plate measuring 30 x 30 cm with a mould-holding device and a guide rail for the hammer.

Dimensions: 1580 x 300 x 300 mm

Weight: 45 kg

B0040/1 Marshall Army-type hammer, weighing 4.5 kg and free-fall of 457 mm



Marshall automatic compactor

B0042 The Marshall automatic compactor is designed to eliminate the tedious process of manual compacting.

This machine automatically compacts the sample and stops the motor once the number of impacts previously selected on a digital display have been completed.

Power supply: 220 V 50 Hz

Hammer weight: 4.5 kg

Fall height: 457 mm

Dimensions: 320 x 320 x 1600 mm

Weight: 95 kg



B0042/1 Automatic compactor hammer.

B0046 Marshall paper, box 100 filters.

B0043 Marshall mould made from anti-corrosion treated steel.

B0044 Collar to adapt to Marshall mould.

B0045 Base to adapt to Marshall mould.

B0042/2 Soundproof cabin.

B0042/3 Device for the measurement of specimen thickness during compaction, in compliance with UNE EN 12697-10. The device includes a 50 mm transducer with 0.01 mm accuracy and a digital unit that displays the readings in a graph on screen and then transmits them to a PC. Includes software under Windows.

S0024 Manual hydraulic extractor used to extract samples from CBR, Proctor and Marshall moulds.

Hand powered via a hydraulic pump.

Made of galvanised steel.

Supplied complete with Ø 4" and 6" adaptors

Capacity: 50 kN

Dimensions: Ø 300 x 410 mm

Weight: 30 kg

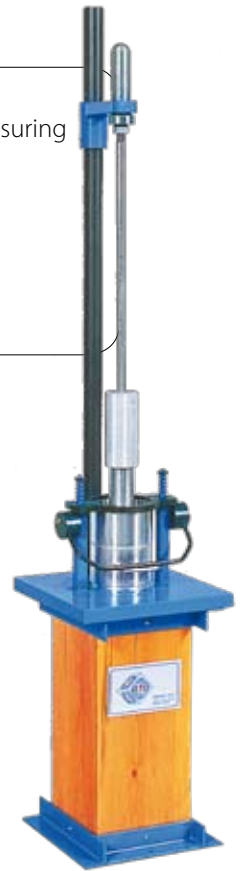

Standards UNE 12697-32
S0293 Vibrating hammer
Test methods for hot bituminous mixtures, part 32.
Laboratory compacting of bituminous mixtures using a vibrating compactor.

Compaction method to prepare for tests on bituminous samples

S0293 Vibrating compacting hammer, complete with mains connection cable and carrying bag. Vibration frequency: 2750 strokes/minute.

Accessories
S0294 Tool tray.

S0295 Tamper, Ø 146 mm, used for CBR, cement gravel tests, etc.

S0299 Support to ensure more complete and uniform compaction.

Built on a steel structure to which the hammer and mould are attached.

EN 12697/9, 12697/10, 12697/32 – NLT 376 - BS 598:104
B0037 PRD mould (Percentage Refusal Density).

Designed to determine the degree of compaction of bituminous pavement. Manufactured in corrosion resistant steel tubes. The mould is opened by generator and includes two hooks that attach it perfectly to the base.

Dimensions: Ø 152 x 170 mm

Weight: 12 kg

Standards NLT 155;
Marshall specimen curing
B0050 Marshall thermostatic bath to cure specimens.

Built with an internal stainless steel bucket with capacity for 15 Marshall specimens.

Supplied complete with digital electronic thermostat for temperature control between 0 and 100°C

Internal dimensions: 550 x 360 x 200 mm

B0051 Marshall thermostatic bath to cure specimens.

Similar to the previous model but with a capacity for 4 specimens.



Marshall test load frames

Standards UNE EN 12697-34, UNE 103-502; NLT -111; ASTM D1559; AASHTO T245; NF P98/251/2 CNR No.30



Marshall stability

It is vital that stability measurements in specimens tested in a press be accurate if the results are to be representative and uniform. The press and the accessories itemised are designed for fast, easy testing by technicians and to generate a record of the results.

B0055 Marshall motor-driven load frame with a capacity of 50 kN, consisting of two sturdy support columns joined by an adjustable crosshead equipped with a ball joint. The load is applied by a mechanical spindle driven by a gearbox at constant speed and double end-stop. Complete with a control panel, main switch and ramp up / ramp down inverter.

Power supply: 220 V 50 Hz

Test speed: 50.8 mm/min

Horizontal spacing: 290 mm

Vertical spacing: 320 mm

Piston stroke: 65 mm

Dimensions: 470 x 440 x 1300 mm

Weight: 90 kg



Accessories

B0056 Thrust piston threaded on the dynamometric ring.

B0057 Disc extractor piston to remove the specimen from the mould.

B0058 Marshall grip made of cast steel. Supplied with gauge accessory to measure deformation. Internal diameter: 101.6 mm

V0005 Dynamometric ring, 10 kN. Supplied complete with dial gauge, 10 x 0.01 mm

V0006 Dynamometric ring, 30 kN. Supplied complete with dial gauge, 10 x 0.01 mm

V0007 Dynamometric ring, 50 kN. Supplied complete with dial gauge, 10 x 0.01 mm

V0016 Dial gauge, 10 x 0.01 mm adaptable to the Marshall grip.

V0025 Recording of the maximum load reading on the dynamometric ring dial gauge.

V0030 Adjustable magnetic base.



Marshall accessories

S0357 Power channel, consisting of: 5000 kgf load cell. Digital load signal. This simple device allows us to read the load applied in the various tests more quickly and accurately than with dynamometric rings. It is also equipped with maximum load memory.

S0358 Displacement channel, consisting of: displacement transducer. Digital display of travel or displacement. This device allows us to read displacements (penetration, deformation) of the load plate in the various tests quickly and accurately.

Indicators

CBR, Marshall and CBR / Marshall presses can be equipped with dynamometric rings and dial gauges. They can also be provided with load transducers and deformation meters, in which case the readings are displayed on digital indicators **H0206 Plus** and **H0206/1**.

H0206/1 Digital display

General Characteristics

14-bit Microprocessor board

Backlit alphanumeric LCD display with 9 mm characters.

Two data channels to connect to load, pressure or displacement transducers.

RS232C port to connect to printer or computer.

Saves data in Excel format. (*.xls)

Measurement units available: N; daN; KN; Kgf; Nm; g; Kg; bar; mbar; Mpa; atm; V; mV; mV/V; mm; µm.

Auto tare key (zero)

Peak activation key.

Key for uploading data to a PC or printer.

PROETI software to save test data and upload them to a PC for printing or storage.



Power supply: 220 V 50/60 Hz
Dimensions: 200 x 80 x 130 mm
Weight: 1 Kg

H0206/PLUS

Digital Force Display Module with Microprocessor **UDI 16/4 PLUS**

16-bit microprocessor board

Back-lit LCD display with 240 x 128 pixel.

Four programmable data collection channels for connection to force, pressure or displacement transducers.

Two RS232C outputs for connection to a printer or PC.

Saves data in Excel format. (.xls)

Measurement units available: N; daN; KN; Kgf; Nm; g; Kg; bar; mbar; Mpa; atm; V; mV; mV/V; mm; µm.

Menu available in 4 languages (Spanish, English, Portuguese and Italian).

PROETI UDI16/4PLUS software for data/curve collection in real time.

Choice of the specimen area to test.

Selection of degree of load (N/s; Mpa/s; kg/cm²*s) and tolerance ± % of value entered

Display of measurement channels selected by the user.

Automatic calculation of Maximum Load (Fm), Unit Load (Rm) and Mean Value.

Storage of data in Excel format.

Allows recorded data to be uploaded to a PC in Excel format (.xls).



Power supply: 220 V 50/60 Hz
Dimensions: 230 x 145 x 180 mm
Weight: 2 kg

H0208 PROETI UDI Software. This software is used for test management and real time display on a PC at the same time, characteristic test curve for load/time or load/deformation (depending on the settings of the **H0206/1** module). The curve data can be saved in Excel format. The software is supplied separately and only runs on the **H0206/1** module.



Marshall test software

The **DATA STORAGE** application is common to all devices. Its user-friendly menus allow the user to choose a pre-defined test or to generate new tests with new control parameters - a useful option for research centres. This application also allows the user to enable, disable or calibrate the sensors.

The software is capable of controlling a large number of tests simultaneously and viewing them in real time. It also has a data recovery system in the event of a power shortage.

The **DATA ANALYSIS** application allows the user to study Marshall test results.

The software supports user selection. The manager generates and defines the tests, and has the capacity to enable and disable the sensors. The operator can only perform the tests, but can not manipulate the settings, thereby safeguarding all the information.

The program can also be accessed remotely.

S0235 Marshall test

The computerised data acquisition system allows the user to measure, analyse and save test related data. All the operations are guided by a menu for maximum simplicity

The second software option for Marshall presses offered by Proetisa is the software included in the multitest machines.

The computerised data acquisition system allows the user to measure, analyse and save test related data. All the operations are guided by a menu for maximum simplicity

The software allows the user to perform CBR, Marshall, simple compression and CBR tests according to UNE 103502, as well as free tests. The software includes machine control files to control the press load, displacement or both. These files allow the user to program all types of tests.

The software can be used to perform compression tests as well as tensile tests, although the machine first has to be equipped with the necessary accessories.

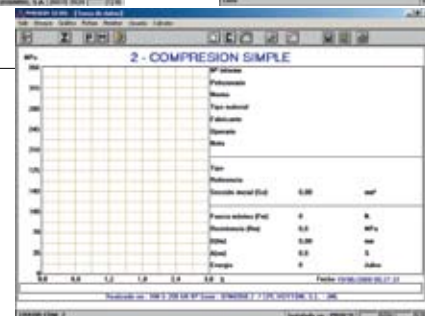
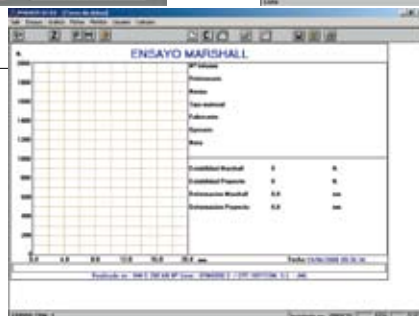
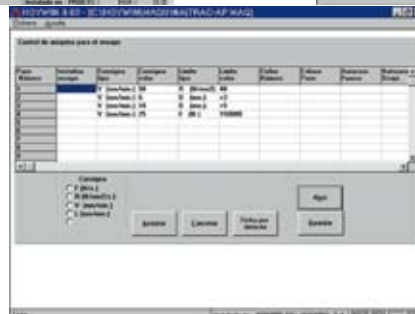
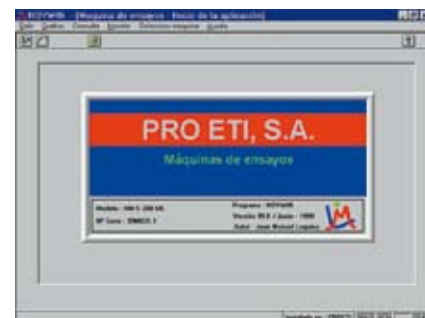
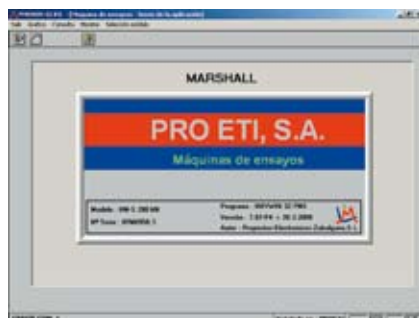

Determining indirect tensile strength

Standards UNE EN 12697-23; ASTM D4123; CNR N.134

B0048 Indirect tensile device.

Used to determine indirect tensile strength of a cylindrical bituminous compound specimen with a diameter 4" or 6". Supplied complete with interchangeable support blades for specimens with diameters of 4" and 6". Anticorrosive cadmium plated.

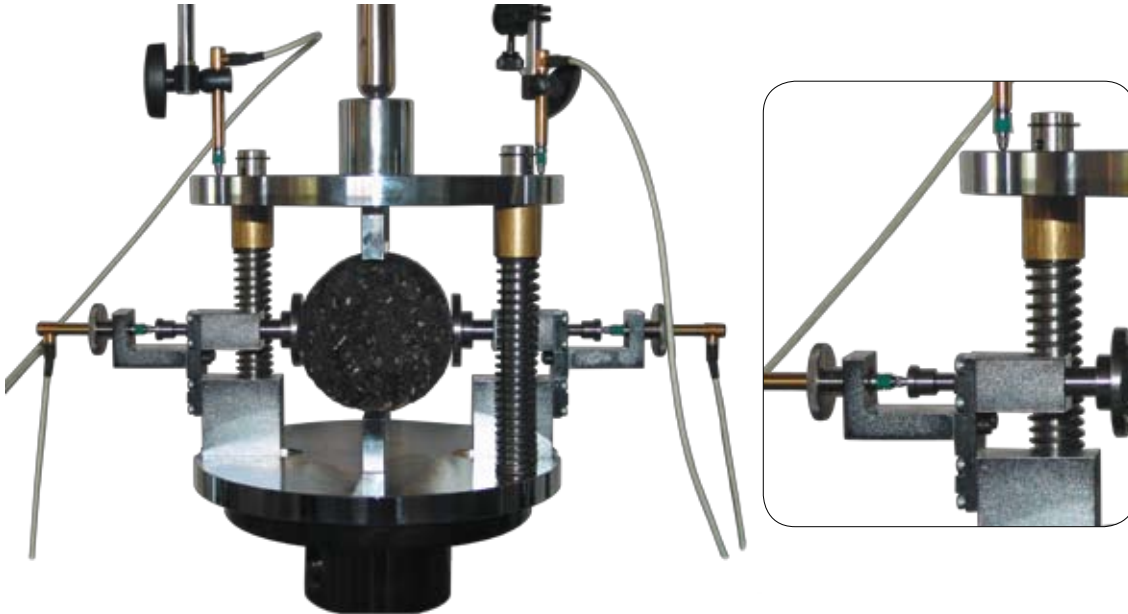

Dimensions: 248 x 270 mm

Weight: 20 kg

The device uses both LVDTs and standard dial gauges (analogue and digital). The fastening system holds the LVDT without damaging it and without the need for any tools. Sample deformation is transmitted by a disc and spring system.

Apart from the two LVDTs used to measure diameter deformation, one or two LVDTs can be used to measure the axial deformation of the sample. The software can work with two, three or four sensors.

The system is completely exportable to any press.

Equipment necessary for the test:

- S0237/1** LVDT displacement transducer 20 mm linear 0.25%
- S0237/4** LVDT displacement transducer 50 mm linear 0.50% (optional)
- V0030** Adjustable magnetic base. (optional)
- S0200** Data collection unit
- S0235E** Software for indirect tensile tests on aggregates.
- B0055** Marshall Press



Determining water sensitivity of bitumen mixtures



Standards UNE 12697-12

Determining water sensitivity of bitumen mixtures

To perform this test, we need a Marshall **B0055** press, a complete indirect **B0048** tensile device and the **B0052 B0052** Digital water bath with cooling system
Temperature range: + 3 °C to 95 °C
Capacity: 42 L
Internal dimensions: 510 x 350 x 230 mm
 The bath can also be used for Marshall tests

Standards UNE EN 12697-18 - EN 13108

B0059 Metal basket measuring 100 x 100 x 100 mm

To determine the drainage of bituminous samples obtained from various mixtures of aggregates with fine minerals or additives. Manufactured in stainless steel plate with Ø 3 mm holes

B0009/1 Tray measuring 160x160x10 mm manufactured in galvanised steel plate.

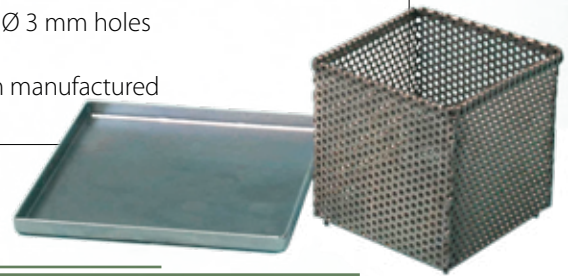

Hubbard - Field method

Standards NLT 160; ASTM D 1138; AASHTO T 169

Hubbard - Field method

A method used to measure skid resistance of bituminous mixtures and binders passing through a 2 mm sieve. The equipment consists of:

- B0065** Cylindrical mould made of hardened steel with 50.8 ± 0.03 mm interior diameter and 120.7 mm high. The recommendation is to have 3 units.
- B0066** Bottom piston made of machined steel, measuring $\varnothing 50.75 \times 50.8$ mm high. The recommendation is to have 3 units.
- B0067** Support made of a square steel section measuring 25.4×75 mm long. The recommendation is to have 2 units.
- B0068** Top piston made of machined steel, measuring $\varnothing 50.75 \times 120.7$ mm high. The bottom of the piston is finished in a cylindrical compression plate. The recommendation is to have 3 units.
- B0069** Extractor made of steel.
- B0070** Cylindrical test mould (Type 1), made of special tool steel, with an internal diameter of 51.3 ± 0.05 mm to a height of 38.1mm from its base and gradual increase in its internal diameter to a maximum of 52.3 ± 0.05 mm at the top. Height: 114.3 mm
- B0070/1** Testing ring made of hardened steel, outer \varnothing of $76.7 \pm 0.13 \times 6.4 \pm 0.25$ mm thick, with a round hole of $\varnothing 44.5 \pm 0.03$ mm
- B0070/2** Centring support to maintain the testing ring perfectly adjusted.
- B0071** Cylindrical testing mould (Type 2) with measurements similar to those of Type 1, with an inner coat of hardened steel to reduce wear .



Immersion compression / simple compression bituminous mixtures

Standards NLT 162, 160; ASTM D 1047; AASHTO T 167

Method used to determine the resistance to simple compression of bituminous mixtures. The equipment consists of:

- B0075** Cylindrical steel mould with internal diameter of 101.6 x 177.8 mm high
- B0076** Bottom piston, \varnothing 101.5 x 50.8 mm high
- B0077** Top piston, \varnothing 101.5 x 201.6 mm high
- B0078** Support with square section measuring 25 x 75 mm long.
- B0079** Extractor with handles for easy mould removal
- B0080** Funnel



Duriez test

Standards NLT 162, 160; ASTM D 1047; AASHTO T 167

Duriez test

This test is carried out to evaluate the characteristics of bituminous components. The test can be carried out with specimens measuring \varnothing 80 or 120 mm. Complete Duriez test set for \varnothing 80 mm, including:

- B0085** Duriez \varnothing 80 mm mould
- B0086** Demoulding cylinder
- B0087** Piston
- B0088** Base

Complete Duriez test set for \varnothing 120 mm, including:

- B0090** Duriez \varnothing 120 mm mould
- B0091** Demoulding cylinder
- B0092** Piston
- B0093** Base



Adhesion test with a Vialit plate

To evaluate the adhesion of bitumen aggregates. This method determines the adhesion of aggregates that are applied to the tread surface of compact asphalt.

Standards UNE EN 12272-3; NLT 313; LCPC

B0097 Vialit test equipment

The equipment consists of a metal base with three pointed vertical rods that support the test plate, one vertical rod 50 cm high with a device on the top for the ball drop, a steel ball weighing 500 g, three test plates and a rubber compacting roller, with a manual pull handle.

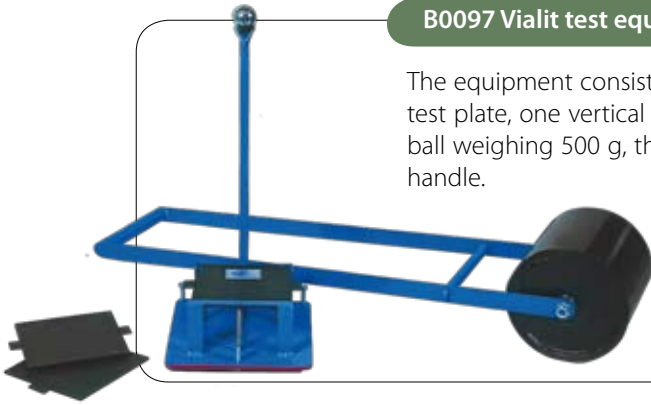

Accessories:

B0097/1 500 g steel ball

B0097/2 Metal test tray

Bituminous grout abrasion

This test is carried out to determine the resistance to wear in wet conditions of bituminous grout used in road construction.

Standards UNE EN 12274-5; NLT 320/87; ASTM D 3910

B0100 Bituminous grout abrasion machine

The machine consists of an electric motor with a vertical testing shaft with planetary rotation, abrasion head, specimen immersion bath, testing base measuring $\varnothing 310 \times 5$ mm thick, three ring moulds and a semi-rigid plastic disc of $\varnothing 300$ mm.

Dimensions: 530 x 550 x 800 mm

Weight: 70 kg

Spare parts

B0100/1 Ring mould for testing.

B0100/2 Abrasion head.

B0100/3 Semi-rigid plastic disc.



Bituminous grout consistency

This procedure is used to determine the optimum amount of water needed in grout for the right level of workability.

Standards NLT 371; ASTM D 3910-84

Consistency of bituminous grout with cone

B0105 This equipment is used to determine the consistency of bituminous grout, and consists of a truncated-cone mould with a top diameter of 38 mm, bottom diameter of 89 mm and height of 76 mm, with a top ridge and graduated base 30 x 30 x 3 mm thick with concentric circles.

Resistance to water

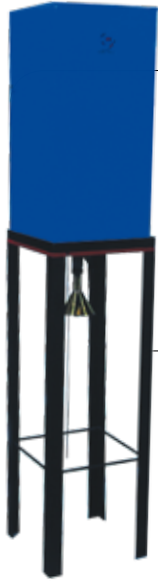

Standards NLT 196/84, 321/84/89

B0107 Constant load spray device

The device consists of a water tank, with an appropriate supply and overflow system to maintain a constant load or height of 774.7 mm of water. The spraying device is mounted on the bottom so the water emerges like rain.

The tank is placed on the four legged metal frame at a height of approximately 1 m.

Dimensions: 1580 x 330 x 330 mm

Weight: 45 kg

Indentation tests in cubic or Marshall specimens

Standards UNE 12697-20

Indentation tests in cubic or Marshall specimens

B0063 Asphalt indentation penetrometer

Equipment consisting of a robust steel frame with a screw on which the weighting discs are placed, two penetrating pistons of 1 and 5 cm² surface area, a 30 x 0.01 mm dial gauge, two plexiglass discs weighing 500 N (51 kg) placed on the load device, stainless steel bath. The device has a discharge tap and an outboard thermostat with electronic temperature control (the moulds and buckets are not included, see accessories).

Dimensions: 530 x 600 x 820 mm

Weight: 160 kg

Accessories:

B0059/1 70.7 mm sample-making mould, easy to disassemble, made of steel.

B0059/2 69 mm bucket for use during the indentation test, made of aluminium.

B0059/3 Steel base to attach the Marshall mould to the device.

B0059/4 Penetrometer calibration device.

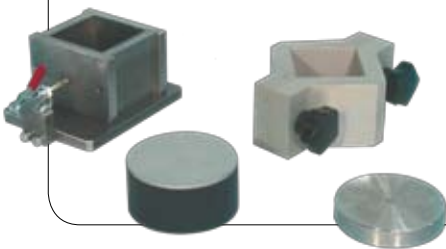

Specimen recovery method using volume calculation

Standards UNE 12697-20

B0064 Vacuum pump method recovery equipment

Device consisting of an electronically controlled thermostatic bath, two 250 mL flasks, an adjustable vacuum pump and a Kitasato flask with vacuum connections.



Resistance to plastic deformation (Wheel Tracker Machine)

Standards EN 12697-22; BS 598: Part 110: 1996; Austroads 01:2004

Wheel Tracker machines according to European standards

The wheel tracker machine is used to evaluate the resistance to permanent plastic deformation of bituminous materials under conditions that simulate the effect of traffic. A loaded wheel passes over a specimen under specific load, speed and temperature conditions and the wheel tread is controlled continuously during the test. The test samples can be specimens that are prepared with a compactor or 200 mm diameter samples.

Standard EN 12697-22 describes two testing methods and both can be performed with this wheel tracker machine. Procedure B of this standard is the more common nowadays. It is regarded as more exact for the measurement of permanent deformation depth at 25 points along the trajectory of the wheel. Only two specimens need to be tested to obtain results for a given material. Proetisa offers a new variant of the wheel tracker machine that tests two specimens at the same time, with the benefit that the test conditions are entirely identical.

The wheel tracker machine is used to

- Identify asphalt mixtures vulnerable to permanent deformation.
- Evaluate new materials and formulas.
- Study the effect of compaction (mixture density and empty content) on resistance to permanent plastic deformation.
- Validation of mixture designs.

Characteristics:

- Easy to use software running under Windows.
- Integrated temperature control chamber.
- Test temperature between 30 °C and 60 °C
- Tests for a specific number of steps or specific tread depth.
- Double-pane glass doors for better test observation.
- Specimen conditioning at test temperature.
- Automatic test start/stop and temperature control.
- The machine is delivered with a calibration certificate.
- The slabs can be compacted by the compacting roller and tested by the wheel tracker machine without removing them from the mould.

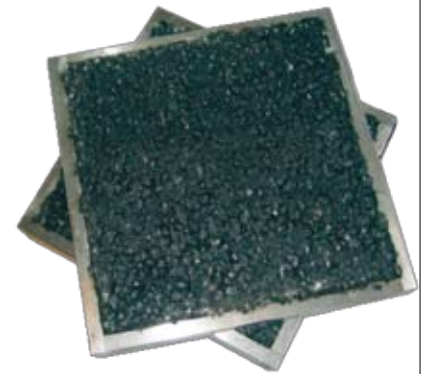

Wheel Tracker machines according to European standards

Equipment components

The WTEN1 equipment consists of an outer solid aluminium structure that holds a stainless steel temperature control chamber controlled by PID; the double-pane glass door offers complete access to the wheel tracker machine.

The test slab is placed on a table that moves over a distance of 230 mm on support tracks at a pre-defined speed. A wheel covered in solid rubber passes over the slab; as the test progresses, the depth of the track caused by deformation is determined by a calibrated displacement transducer. The equipment is monitored and the test data are collected by an interface unit using the software.

The software automatically starts the wheel tracker machine, maintains the required speed, measures the progress in the depth of the permanent deformation and temperature of the slab, provides a continuously updated screen graph of the deformation/depth of the track versus time and stops the wheel tracker machine when the test ends. When the test ends, the permanent deformation speed is calculated and a test report can be printed using the software. If necessary, an Excel worksheet can be used to analyse and compare the saved data with other data.

Software is included for verification of transducers, diagnosis routines and PRT calibration, etc.

The WTEN2 device (B0111) tests two specimens at the same time. It is wider than the WTEN1 (B0110) and the user can access it from both sides.

We also manufacture a wheel tracker machine similar to the one designed by LCPC, described in EN12697-22 and EN13108-20.

Technical characteristics

Speed range: 42 to 52 passes per minute

Wheel load: 520N or 700N

Temperature range: +30°C to +60°C ± 0.2 °C

Slab thickness: 50mm - 100mm

Permanent deformation depth: 0mm to 40mm

Data collection: National Instruments

User languages: Spanish, English, French, Russian, Polish, Hungarian, Rumanian

Power supply:

220 - 240 50-60 Hz / 13 A - 110 -120 50-60 Hz / 32 A

Models:

B0110 WTEN1 one position wheel tracker machine

B0111 WTEN2 two position wheel tracker machine

Dimensions:

B0110: 1580 x 660 x 1730 mm

B0111: 1580 x 860 x 1730 mm

Weight:

B0110: 550 kg

B0111: 680 kg

B0112 Large CRT-WTENLD Wheel Tracker Machine

A wheel tracker machine for large scale measurement of resistance to deformation in bituminous mixtures using the methods described in Standard EN 12697-22, i.e., for loads over 13 tons.

The equipment consists of a solid aluminium structure that houses a stainless steel chamber that controls the temperature by means of a PID (from + 30 °C to + 60 ± 1 °C around the slab). A double-pane glass door offers complete user access.

The test slabs are placed on a table and apply a load of 5000 N ± 50 N. Both load and load conditions can be changed during the test. Two tyres move making a sinusoidal movement back and forth over a distance of 410 mm. The frequency is normally 1 Hz but it can be adjusted.

The equipment is monitored and the data is collected by an interface unit. The operator controls the machine with an IBM PC or XP that runs the software. It also includes a depth gauge to measure local deformation.

Software

The software automatically starts the wheel moving and pushes the slabs against it. The graph on the screen shows updated deformation/depth of the track versus time and stops the machine at the end of the test. The readings are saved automatically. Finally, the progress of the track graphs can be seen in 3D. When the test ends, the saved data can be analysed in an Excel worksheet or printed in a report.

Power supply: 220-240 AC supply of 13A

Dimensions: 2070 x 1550 x 1800 mm h

Weight: 1000 kg



Servo-pneumatic Testing System

Standards EN 12697- 24, 12697- 25, EN 12697- 26; ASTM D4123, D3497; AASHTO TP31, TP8, TP62, TP46, T307; BS DD 226; NCHRP 1-28A

B0115 Universal machine for servo-pneumatic asphalt tests

This machine has a high-precision servo-valve, as well as a low friction actuator (especially adapted) and sophisticated data collection capabilities that guarantee operation to match many servo-hydraulic systems.

In conjunction with advanced Windows software, this system generates the wave shapes applied by the actuator in digital form so the materials are tested under conditions similar to those applied by static or moving vehicles. The actuator works in two directions so it can apply both compression and tensile loads. This provides high quality control over the shape of the load wave and allows the user to apply tensile and compression loads cyclically at high frequencies. The majority of these international standards are available in software. If necessary, the users can use the Labview software platform to develop their own applications.

Characteristics

Digital control system

Operation at frequencies as high as 70Hz static 14 kN by 7bar (static 19 kN by 10 bar) 9 kN in 2.5Hz for modulus tests (sufficient for most high modulus materials)

Internal displacement transducer for exact position control

Data collection and control system with 16 bit digital servo-control precision.

Load and strength transducers calibrated in accordance with standards.

Transducers available for triaxial, modulus and permanent deformation tests.

A wide range of accessories for tests are available for asphalt mixtures and non-binded materials.

Usually delivered with our temperature control chamber (- 10 °C to + 60 °C, ± 0.2 °C)

Software to perform North American and European tests

Universal test software routine

The CRT-NU14 can be used to:

Design mixtures

Determine finished product specifications

Evaluate new materials

Investigate cracks

Evaluation of pavement – Quality control

The equipment consists of:

The CRT-NU 14:

Stainless steel testing frame with a height-adjustable crosshead.

Pneumatic actuator with a pneumatic servo-valve and integrated displacement transducer (maximum static load 14 kN).

Load transducer (capacity 20 kN).

Data collection and control system includes:

Power supplies

Signal conditioning for the load transducer for 2 thermocouples and 2 displacement transducers (2 additional displacement transducers optional).



Universal machine for servo-pneumatic asphalt tests

Servo-amplifier for PID control of the servo-valve.

High speed multifunction board, 16 bit analogue to digital, 12 bit digital to analogue, digital input-output for closed loop computerised control of the system (National Instruments).

The pneumatic components include a filter, regulator and piping, all the electric and signal cables, thermocouples, software and instruction manual.

Software

Easy to use software under Windows, written in Visual Basic and Labview by National Instruments, allowing the user to set the parameters for his own test applications, supported by powerful development software.

Complete flexibility for test data results on screen with progress display, dials and a large selection of linear or algorithmic graphs.

The test results can be saved in MS Excel compatible format.

Static, sinusoidal, square, triangular load models or user-defined models.

To operate correctly, the software must be installed in a PC compatible with Windows XP or higher.

Specifications

Maximum load: 14 kN by 7 bar and 19 kN by 10 bar

Load transducer: ± 20 kN (3 m V/V)

Piston stroke: ± 15 mm

Piston frequency: Static up to 70 Hz

Data collection: National Instruments

User languages: Spanish, Portuguese, English, French, Italian, German, Russian, Polish, Hungarian and Rumanian

Power supplies: 220 - 240 / 13 A supply at 220 - 240 50-60 Hz / 13 A - 110 -120 50-60 Hz / 32 A

Dimensions: 340 x 320 x 700 mm

Weight: 30 kg

The equipment requires the use of an air compressor at 14 bar, 150 L and 3 Hp

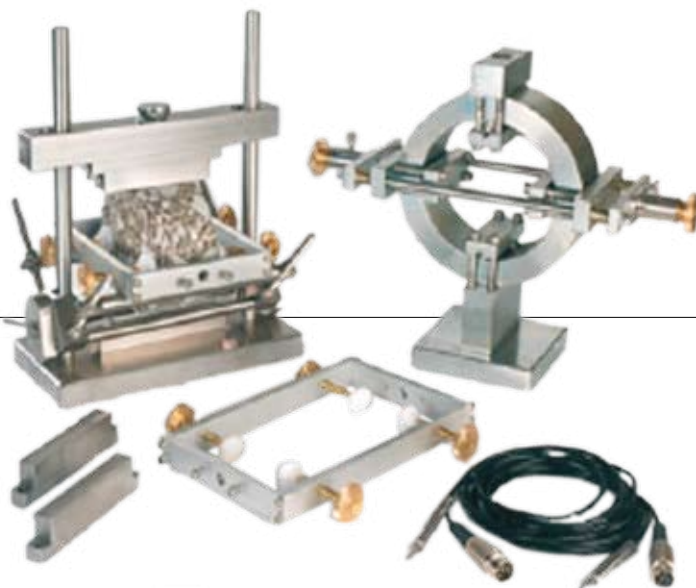
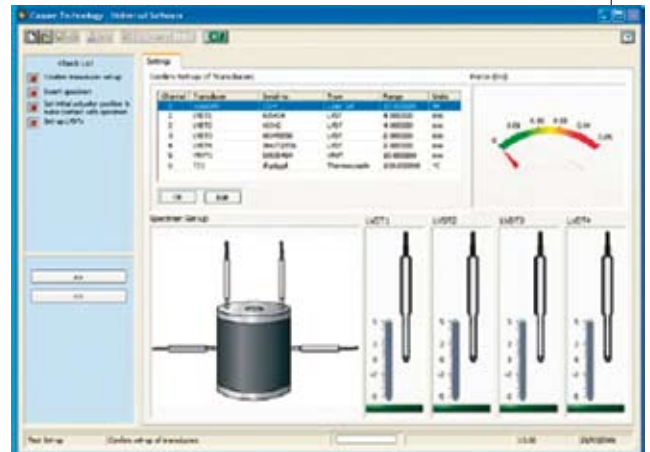

Temperature control during the test

B0125 Temperature control chamber

When tests are performed on asphalt mixtures, temperature control is essential. Test data show that a 1% change in temperature can cause a 10% variation in rigidity results.

This chamber allows the user to control the temperature by 0.2 °C between -10 °C and + 60 °C using the CAL3200 digital temperature controller. Forced air circulation ensures uniform temperature inside the chamber. The condensed water circulates through a pipe behind the chamber to a heated tray underneath, where it evaporates.

The chamber also has a device to prevent high temperatures that stops the fans, heating and cooling and lights up a pilot light if the temperature is higher than that indicated by the system. The front door is all double-thickness glass and has a heating element so is always clear.

Specifications

Temperature range: -10 °C to + 60 °C

Cooling capacity: 560 W

Heating capacity: 1.5 kW

Connection: 230 V

Volume: 625 litres

Dimensions: 800 x 710 x 2000 mm

Weight: 195 kg



Universal servo-hydraulic systems

Standards ASTM D4123; BS DD 226; EN 12697 -26; BS DD 213; EN 12697 -24; ASTM D3497; AASHTO TP31; EN 12697 -25; AASHTO TP8; ASTM D3999; AASHTO P46; ASTM D531 1; AASHTO T307

Universal servo-hydraulic systems

B0116 Universal servo-hydraulic testing machine

This machine can test a range of bituminous pavement mixtures, sub-grade soils and sub-base granular materials. Its maximum load capacity is more than 25 kN for high rigidity mixtures. The apparatus is inexpensive, easy to use and does not require very much maintenance. It was designed to provide laboratories with a means to perform a wide range of tests on asphalt mixtures and non-binded materials.

Characteristics

High frequency cycles.

Closed loop controlled system.

Internal displacement transducer for exact position control. Transducers available for triaxial, modulus and permanent deformation tests.

A wide range of accessories for tests area available for asphalt mixtures and non-binded materials.

Tests on samples with diameters of 100 mm and 150 mm.

Delivered with our temperature control chamber (- 10 °C to + 60 °C, ± 0.2 °C).

Software to perform North American and European tests.

Free software updates.

Universal test software routine.

The machine can be used to:

Design mixtures

Determine finished product specifications

Evaluate new materials

Investigate cracks

Evaluate pavement – Quality control

The CRT-HYD25

A sophisticated system of data collection and control is used to generate wave-forms digitally so that materials are tested under conditions similar to those applied by static or moving vehicles.

The load frame is manufactured inside a temperature control chamber and the cross beam supporting the subsystems can be adjusted to the desired height.

Servo-hydraulic system with digital control.

Very sturdy 25 kN load structure with vertical bars.

Temperature control chamber with double-thickness glass door (- 10 °C to + 60 °C, ± 0.2 °C)

All the transducers have linear signal conditioning and range of results ± 10 V

Transducers are calibrated in accordance with national standards.

Wide range of accessories and triaxial cells for specimens of non-binded materials with 100 and 150 mm diameters.

Data collection and control system with digital 16 bit servo-control using any input channel.

Programmable PID control.

Up to 16 channels with 16 bit input.

Software and instruction manual.

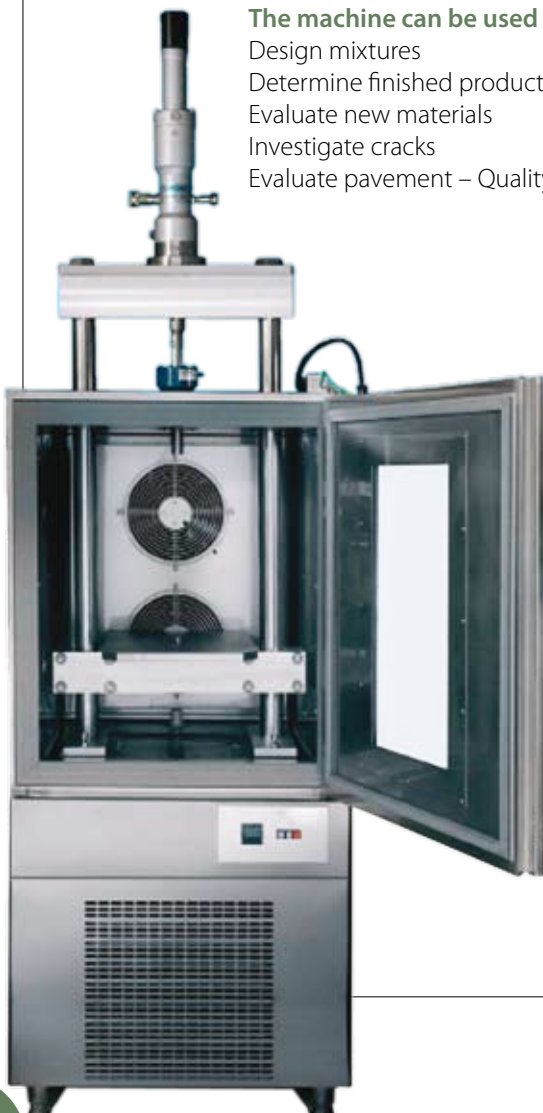

Software

Software

Easy to use software running under Windows, written in Visual Basic and Labview by National Instruments, allowing the user to set the parameters for his own test applications, supported by powerful development software.

Complete flexibility for test data results on screen with progress display, dials and a large selection of linear or algorithmic graphs.

The test results can be saved in MS Excel compatible format.

Static, sinusoidal, square, triangular load models or user-defined models.

Specifications

Maximum load: 25 kN

Load transducer: ± 25 kN

Piston stroke: ± 50 mm

Piston frequency: Static up to 70 Hz

Data collection: National Instruments

User languages: Spanish, Portuguese, English, French, Italian, Russian, Polish, Hungarian

Power supplies: 220-240 / 13A - 110-120 / 3A supply of 220 - 240 50-60 Hz / 13 A - 110 -120 50-60 Hz / 32 A

Frame Dimensions: 780 x 840 x 2700 mm

Frame weight: 780 kg

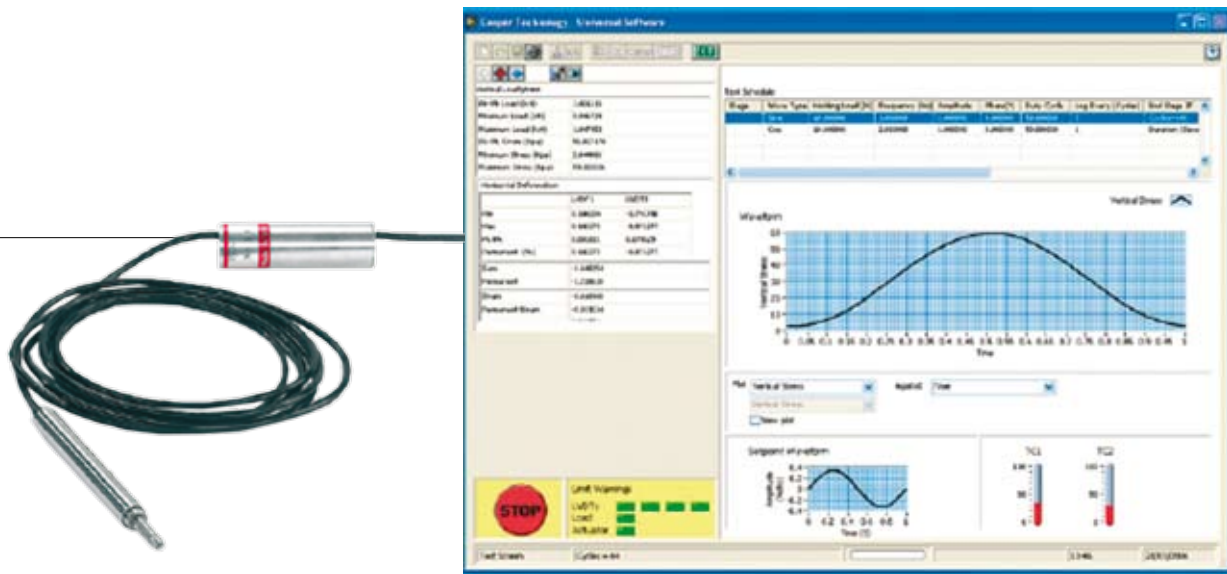

Fatigue test

Standards EN 12697-24, EN 12697-26; AASTHO TP8

B0118 Fatigue testing equipment

This system for testing fatigue on four flexure points on a beam is completely autonomous and uses cutting-edge technology as described by the new European standard.

The equipment consists of:

Sturdy stainless steel and anodised aluminium structure.

Pneumatic actuator with a servo-valve and integrated displacement transducer (Dynamic load 5 kN)

Load transducer (capacity ± 5 kN).

Characteristics:

Data collection and control system includes:

Power supplies.

Signal conditioning for the load and displacement transducers and LVDT actuator.

Digital signal processor control unit for high speed data collection and PID control of the servo-valve.

Real time high speed controller, 16 bit analogue to digital, 16 bit digital to analogue and digital input-output unit for the closed loop computer control system.

Pneumatic components including filters, regulator and pipes.

Power and signal cables.

Machine test and diagnosis software.

Specifications

Maximum load: 5 kN

Piston stroke: ± 15 mm

Static piston frequency up to: 100 Hz

National Instruments data collection

User languages: Spanish, Portuguese, English, French, Italian, Russian, Polish, Hungarian

Power supplies: 220 - 240 50 - 60 Hz / 13 A - 110 - 120 50 - 60 Hz / 32 A

Dimensions: 340 x 320 x 700 mm

Weight: 30 kg

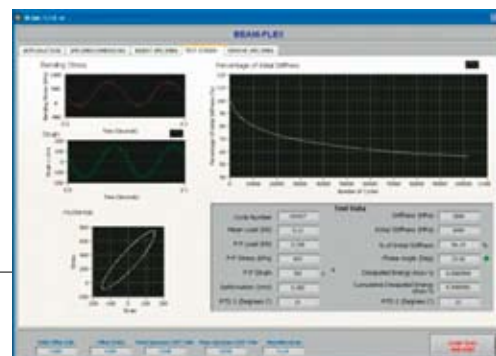

Roller compaction

Standards UNE 12697-33

B0120 Roller compactor

Roller compaction is considered the best method for laboratory preparation of samples from manufacturers that make asphalt pavement slabs with the properties closest to the conditions of road materials.

The pneumatic roller compactor was designed to provide a solution for the problem of manufacturing homogeneous slabs in a laboratory that are large enough to be used in the wheel tracker machine. It is used to compact to a certain mixture density or to apply standard compression stress (compaction energy) in a wide range of bituminous materials.

The samples can be between 50 and 100 mm thick. We have a complete selection of moulds. The roller compactor can apply loads of up to 30 kN on a width of 305 mm, equivalent to heavier onsite compaction equipment. The roller compactor is controlled by a PLC and both the number of steps and the level of compaction can be selected. A safety cabin protects the equipment, which will not run unless the access doors are closed.

The equipment can compact square samples measuring 305 x 305 mm, and it is also designed to compact samples of 305 x 405 mm, so that prisms can be obtained for the fatigue test.

The Roller Compactor B0121 can compact samples measuring 500 x 180mm

Maximum load: 30 kN over a roller width of 305mm at 7 bar (38kN at 9 bar)

Carriage travel: Ø 150 mm

Time cycle: variable up to 10 cycles/minute

Vibration frequency: 0 – 50 Hz

User languages: Spanish, English, French, Polish

Power supply: 220-240 AC supply of 13A

Dimensions: 1600 x 1000 x 1520 mm h

Weight: 596 kg



Accessories to use with the B0120 roller compactor or Wheel Tracker machine:

- B0120/1** Mould for the compactor or Wheel Tracker machine, dimensions 305 x 305 x 50 mm
- B0120/2** Mould for the compactor or Wheel Tracker machine, dimensions 305 x 305 x 100 mm
- B0120/3** Mould for the compactor, dimensions 305 x 405 x 50 mm
- B0120/4** Mould for the compactor, dimensions 305 x 405 x 100 mm
- B0120/5** Insert to adjust mould depth, dimensions 305 x 305 x 10 mm
- B0120/6** Insert to adjust mould depth, dimensions 305 x 405 x 10 mm

B0121 Roller compactor

Similar to model B0120 except that it compacts samples measuring 500 x 180 mm

Maximum load: 30 kN over a roller width of 305mm at 7 bar (38kN at 9 bar)

Carriage travel: Ø 150 mm

Time cycle: variable up to 10 cycles/minute

Vibration frequency: 0 – 50 Hz

User languages: Spanish, English, French, Polish

Power supply: 220-240 AC supply of 16A

Dimensions: 1920 x 1150 x 1520 mm h

Weight: 610 kg

*This equipment requires the use of an air compressor

Accessories to use with the roller compactor or Wheel Tracker machine:

B0121/1 Steel mould for the compactor or Wheel Tracker Large machine, dimensions 500 x 180 x 50 mm

B0121/2 Steel mould for the compactor or Wheel Tracker Large machine, dimensions 500 x 180 x 100 mm

B0121/3 Steel mould for the compactor or Wheel Tracker Large machine, dimensions 600 x 400 x 100 mm

B0121/4 Steel base for the compactor to level the surface of the sample, dimensions 500 x 180 x 10 mm

B0121/5 Steel base for the compactor to level the surface of the sample, dimensions 600 x 400 x 100 mm

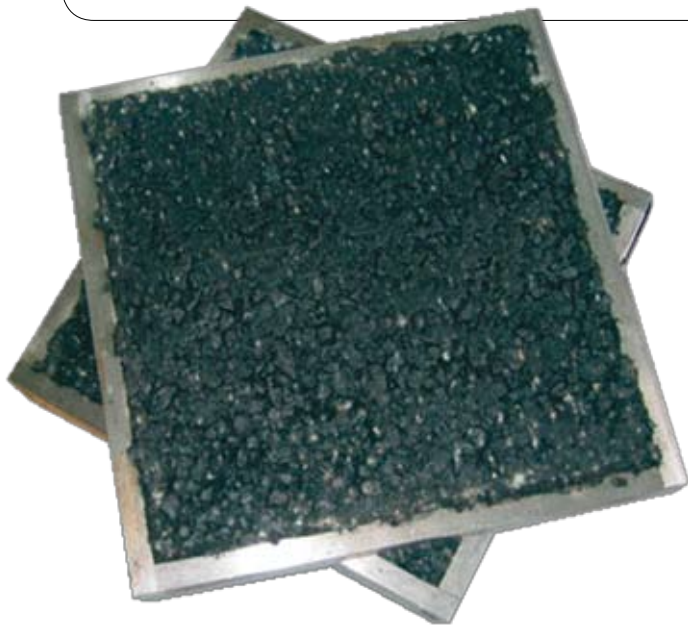

Gyratory compactor

Standards UNE EN 12697-10, 12697-31

Gyratory compactor

The gyratory compactor is manufactured in a high strength, sturdy steel frame.

The loads are applied by a pneumatic cylinder controlled by a high precision pressure regulator. Height is measured by a linear displacement transducer. The rotating movement is generated precisely with an eccentricity having an angle of rotation of 0.082 °C.

The compactor is small but can be used to test all emulsion types. Speed is controlled by a computer which also controls the inverter.

The test software allows the user to choose from several test methods with different density objectives or a specific number of rotations. The software gives the instruction to apply the load and rotation begins. The number of rotations, compaction depth and density are all displayed on the screen. At the end, the software retracts the load and stops the rotation. A high speed USB port connects the compactor and the computer.

The system includes National Instruments software, data collection card and equipment control.

The B0122/11 software requires a computer with Windows XP. The computer is not included and can be ordered separately.

Technical characteristics:

Voltage: 230 AC / 13 A – 115 V, 50-60Hz 32 A (also available)

Dimensions: 500 x 800 x 2000 mm

Work space needed: 750 x 1700 x 2000 mm

Weight: 350 kg

Requires a compressor that can reach and maintain a pressure of 7 bar (150mm specimens)

Accessories:

B0122/1 Hardened cylindrical mould and plate measuring Ø 100 mm

B0122/2 Hardened cylindrical mould and plate measuring Ø 150 mm

B0122/3 Hardened cylindrical mould and plate measuring Ø 100 mm, with holes for emulsions.

B0122/4 Hardened cylindrical mould and plate measuring Ø 150 mm, with holes for emulsions.

B0122/5 Filter paper of Ø 100 mm (pack 100 units)

B0122/6 Filter paper of Ø 100 mm (pack 150 units)

B0122/7 Pneumatic sample remover.

B0122/8 Angle calibration equipment.

B0122/9 Load calibration equipment.

B0122/10 Air compressor, low noise (filter included).
230V 50Hz

B0122/11 Test management and control software



Samples, preparation and tests

Preparation and care in sampling is absolutely essential to ensure precise, reliable test results. Samples are generally taken to verify the average quality of a delivery or to check uniformity of quality over a whole batch.



Standards ASTM D 140; AASHTO T40

B0130 Bacon sampler

This sampler has a capacity of 237 mL and is used to obtain asphalt samples at various depths within a deposit. The sampler consists of a cylindrical body with top and bottom lids and a conical plunger that acts like a valve when taking in the sample. The top lid has a closing mechanism that keeps the plunger closed once the sample has been taken. Both the upper and middle part of the sampler have holes for tying a string (not included) to hold the sampler while taking the samples.

Dimensions: Ø 50 x 250 mm

Weight: 1 kg

Standards NLT 155; ASTM C188, C189; BS 812

Relative density of the filler

B0135 Pycnometer with capacity of 250 mL made of glass with three concave areas at the bottom for improved stirring of the sample in the container. Provided with a funnel for easy introduction of the sample into the pycnometer.

Total length: 255 mm



Standards NLT 122; ASTM D70; AASHTO T22; ISO 3838; BS 4699

Relative density

B0138 Hubbard-Carmick type pycnometer with 25 mL capacity

B0139 Hubbard-Carmick type pycnometer with 24 mL capacity

V5561 Gay-Lussac type pycnometer with 25 mL capacity



Determination of Loss on Heating

This method is used to determine the effect of heat and air on a film of bituminous material in motion.

Standards UNE EN 12607-2; 13303; NLT -128, 147; UNE 104.281; ASTM D6, D1754; AASHTO T179; BS 2000

Oven with rotating shelf

B0150 An oven used to determine weight loss, with a thermally insulated internal chamber made of stainless steel. The door is airtight, with a double panel and a window measuring 220 x 230 mm with double tempered glass. The temperature is controlled by a microprocessor with a digital display from room temperature to 200 °C.

A Ø 250 mm aluminium rotating platform holds up to 9 test capsules measuring Ø 55 x 35 mm that rotate at between 5 and 6 rpm.

The oven is delivered with 9 test capsules and an ASTM 13C thermometer.

Power supply: 220 V 50 Hz

Internal dimensions: 660 x 450 x 420 mm

Overall dimensions: 1120 x 775 x 630 mm

Weight: 62 kg

Spare parts

B0150/1 Aluminium rotating shelf.

B0166/5 Brass container Ø 55 x 35 mm

B0150/3 Aluminium rotating plate with two Ø 140 x 9.5 mm containers to determine the thin film, in compliance with EN 12607-2

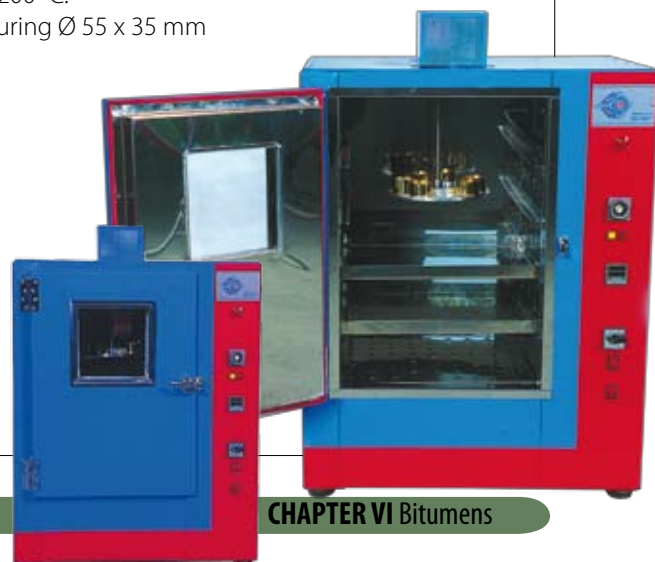

Flash point and ignition point

Standards NLT -185, 186; ASTM D2872; AASHTO T240

B0151 RTFOT - ASTM Oven

An oven built entirely of stainless steel and thermally insulated with fibre glass, used to determine the effect of heat and air on rotating bituminous materials in the form of a fine film; an airtight door with double panels and double tempered glass for inspection. A vertical \varnothing 305 mm aluminium rotating platform holds up to 8 glass capsules that rotate at 15 ± 0.2 rpm.



Supplied complete with digital, electronic precision temperature control to keep the temperature constant at 163°C , control thermometer, ventilation system and glass capsules.

Power supply: 220 V 50 Hz 1300W

Dimensions: 620 x 620 x 910 mm

Weight: 60 kg

Spare parts

B0151/1 Glass container \varnothing 64 x 140 mm

V1013 ASTM 13C thermometer, range 155 to 170°C



Standards EN 12607-1

B0151 RTFOT - EN Oven

Similar to model B0151 except for the test chamber, that has been modified to meet the specifications of Standard EN 12607-1.



Bitumen distillation

The test consists of distilling a sample under specific conditions, collecting and measuring the amount distilled at previously specified temperatures. The final distillation residue and the distillation fractions can be determined later by appropriate testing.

Standards UNE EN 13358; NLT 134; UNE 7.112; ASTM D402; AASHTO T78

B0155 Equipment for distilling fluidified bitumen

Complete delivery includes the following equipment:

- B0155/1** Distillation flask, capacity 500 mL
- B0155/2** Flask protection device.
- B0155/3** Glass cooler.
- B0155/4** Extension with 105° angle
- V1008** ASTM 8C thermometer (- 2 + 400 °C)
- B0155/5** 100 mL specimen
- B0155/6** Container for residue 75 x 55 mm
- V0290** Bunsen gas burner.
- V0223** Ring with bosshead to hold the flask.
- V0191** Plate base support (2)



Standards UNE EN 1431; NLT -139; ASTM D244; AASHTO T59

Asphalt emulsion distillation residue

- B0157** Complete equipment to determine distillation residue, including the following components:
- B0157/1** Distillation retort.
- B0157/2** Butane gas ring burner, Ø 120 mm
- B0157/3** Glass elbow release tube.
- B0157/4** Zinc protector.
- B0157/5** Glass cooler.
- B0155/5** 100 mL specimen
- V0290** Bunsen burner
- V0223** Ring with bosshead to hold the retort
- V0191** Plate base support (2)

Accessory:

- V1007** ASTM 7C thermometers (2) (- 2 + 300 °C)

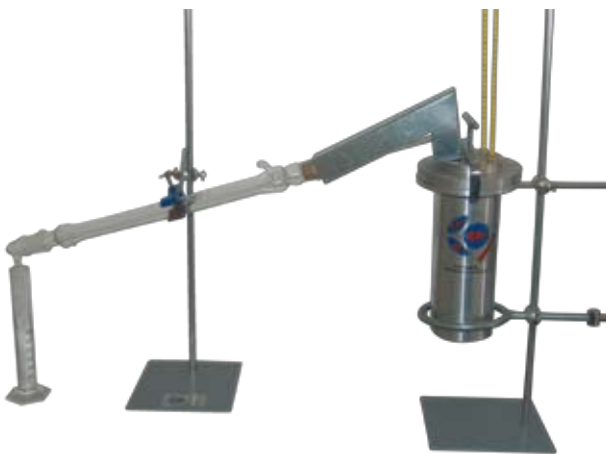

Standards NLT -189

Tar distillation

- B0159** Tar distilling equipment, compete with the following components:
- B0155/1** Distilling flask.
- V1008** Thermometer - 2 + 400 °C.
- B0155/2** Flask protection device.
- B0159/3** Glass cooler Ø 20 x 600 mm
- B0159/2** 25 mL specimen
- B0155/5** 100 mL specimen
- V0290** Bunsen burner
- B0159/1** Metal support with clamp



Softening point

Bituminous binders do not change from a solid state to a liquid state at any specific temperature. However, if special care is taken in increasing the temperature applied to a binder sample, we can define the temperature at which the binder will flow for a specific distance. Therefore, the consistency and quality of the binder can be determined.

Standards NLT - 125; ASTM D36, E28; AASHTO T53; DIN 52011; EN 1427

B0160 Complete ball and ring apparatus

Designed to determine the softening point of bitumen, consisting of: two test balls, two rings, two centring guides, a height-adjustable lid and a heat resistant beaker.

Accessories

- V0912** Thermometer 0 - 100 °C
- V0914** Thermometer 0 - 200 °C
- V1015** ASTM 15C thermometer
- V1016** ASTM 16C thermometer
- B0160/5** Magnetic stirrer, with heater.
- V0290** Bunsen burner
- V0207** Metal fabric with ceramic fibres, 100 x 100 mm
- B0160/6** Disposal plate measuring 50 x 75 mm with edges

Spare parts

- B0160/1** Test ball
- B0160/2** Centring guides
- B0160/3** Brass ring
- B0160/4** Ball and ring heating plate



Standards ASTM D36, E28; IP58; DIN 52011; EN 1427; NFT 66008; ISO 4625

B0160 Automatic ball and ring apparatus

Equipment with two independent test cells for double determination of bituminous material softening points, wax, rubber, adhesives and similar products, in a temperature range from 0 to 250 °C, using distilled water (up to 85°C), glycerol (from 80 to 157°C), ethylene glycol (from 30 to 110°C), paraffin, mineral oil or silicone oil (from 80 to 199°C). The test method consists of placing two horizontal cast bitumen discs in brass rings and heating them in a bath under controlled conditions (4.5 to 5.5 °C per minute) while each holds a steel ball. The temperature values for stirring, detection and safety are automatically controlled, recorded and displayed on the equipment processing unit or a computer.

Technical specifications

- Complete equipment in compliance with standards, including complete diagnosis.
- Choice of selection method.
- Indication and program for monitoring, sample and results
- Print out of results, testing data and control of heating at the end of the test.
- RS 232 C port for PC and parallel connection with 25 pin connection for a printer.
- Supplied with ticket printing, PC connection and power supply cables.
- Stirrer with two programmable speeds and four blades to ensure good temperature stability.
- Drop detection via light screen and sensitivity adjustment by software.
- Programmable sample temperature settings at the beginning and the end of the test.
- Drain system in case of beaker rupture.
- Sample temperature measurement by 4 PT100 glass probes (1/10 °C).
- Compact keyboard on the front panel of the upper module.
- Electronics insulated from hot and mechanical components.
- Automatic calibration software and test parameter file.

The equipment is supplied complete with RS 232C ports, standard beakers, two rings with protruding edges, a set of 10 balls, support for two samples, PT 100 temperature probe, stirring blade, electric stirrer support and automatic fan cooling system.

Power supply: 230 V 50/60 Hz single phase

Consumption: 1200 W

Dimensions: 260 x 535 x 500 mm

Weight: 20 kg



Bitumens and bitumen binders

Determining rupture behaviour.

Determining the mixing time for fine aggregates with cationic bituminous emulsions.

Standards EN 13075-1

B0162 Equipment for manual determination of cationic emulsion rupture values

Consisting of:

- Complete dispenser funnel with base plate support, chatteway spatula and two porcelain capsules.



Penetration

This test is used to determine the penetration value of bituminous materials. Penetration is understood as the depth in tenths of millimetres to which a needle of specific characteristics penetrates vertically in a material sample under precise load, time and temperature conditions.

Standards UNE EN 1426; NLT 124; UNE 104281-1-4; ASTM D5, D217; AASHTO T49; BS 2000

Penetration

B0165 A standard penetrometer to determine the consistency of a sample of bituminous material, under fixed load, time and temperature conditions. A sturdy piece of apparatus with a light alloy base plate, adjustable legs, chrome displacement bars and height adjusting device. The probe is free-fall, made of brass. The \varnothing 150 mm quadrant is divided into 360 degrees of 0.1 mm. Supplied complete with a release and stop push button, automatic zero reset, displacement control, set of 50 and 100 g weights, penetration needle and \varnothing 55 x 35 and 70 x 45 mm brass containers.

Dimensions: 220 x 170 x 410 mm

Weight: 11 kg



B0166 A standard digital penetrometer to determine the consistency of a sample of bituminous material, under fixed load, time and temperature conditions.

Apparatus with characteristics similar to the **B0165** model except for an electromagnetic control system that allows the penetrating head to fall automatically so the needle free-falls during the five second duration of the test. Supplied complete with a set of 50 and 100 g weights, penetrating needle and \varnothing 55 x 35 and 70 x 45 mm brass containers

Power supply: 220 V 50 Hz

Dimensions: 220 x 280 x 410 mm

Weight: 15 kg

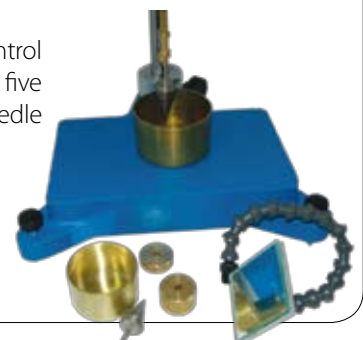

Penetration (accessories)

Accessories:

B0166/1 Thermostatic bath with digital temperature reading.

Supplies water at the required temperature (25 ± 0.1 °C). Made from stainless steel, with a capacity of 10 L, insulating fibre and digital thermostat heating. Recirculation water pump with connections and cooling coil.



Power supply: 1 x 220 V.50/60 Hz

Dimensions: 375 x 335 x 420 mm

Weight: 12 kg

B0166/2 Mirror, for easy control of the needle with the test specimen.

Spare parts:

B0166/3 Penetrating stainless steel needle.

Diameter: 1 mm

B0166/4 Glass transfer disc with support.

B0166/5 Brass container, Ø 55 x 35 mm used for hard bituminous materials.

B0166/6 Brass container, Ø 70 x 45 mm used for light bituminous materials.

V1017 ASTM 17C thermometer (+19 °C to +27 °C)

**B0165/1** Water bath with thermostatic coil included

The unit is used with the B0166/1 bath. It maintains the temperature of the bituminous sample directly over the penetrometer, preventing its transfer.

Flash point and ignition point

This method is used to determine the flash and ignition points of the bitumen, measuring the temperature at which the bitumen should be heated under certain test conditions to produce a specific amount of vapour that forms an inflammable mixture with air.

Standards UNE 51023; NLT -127; ASTM D92; AASHTO 48; BS 4689; IP 36/67

Cleveland Apparatus

B0145 Cleveland Apparatus with electrical heating, complete with aluminium container, thermometer from - 6 to + 400 °C, electric thermoregulator, heating plate, rod and thermometer clip.

Power supply: 220 V 50 Hz 700 W

Dimensions: 160 x 230 x 580 mm

Weight: 10 kg

Accessories:

B0145/1 Dispositive gas heated.

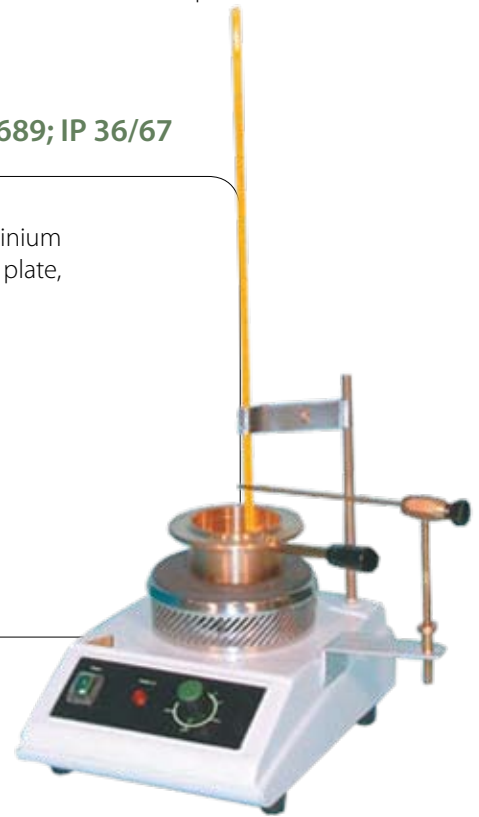

Standards ASTM D1310, D3143

TAG Viscometer

B0148 Open cup TAG viscometer used to determine the flash points of volatile substances. Suitable for values between 0 and 175 °F. Supplied complete with cup, bath, thermoregulator and thermometers. ASTM 9C from - 5 to + 110 °C and ASTM 57C from -20 to + 50 °C.

Power supply: 220 V 50 Hz 600 W

Dimensions: 200 x 300 x 400 mm

Weight: 6 kg



Viscosity and consistency

Viscosity is a fundamental characteristic of bitumen. It is used to determine how material behaves in use. For example, flow speed at a certain temperature and the temperature required for perfect application.

Standards ASTM D 940, D 1655 – AASHTO T54 – BS 2000 – CNR No. 102 – NF T66-020



B0152 Engler Digital Viscometer

Used to compare the specific viscosity of oils and tars used on roads with water viscosity. Consists of a water bath made of stainless steel with a precision digital thermoregulator, electrical stirrer, cooling unit and Engler flask. Equipped with double safety thermostat to prevent overheating.

Power supply: 220 V 50/60 Hz - 300 W

Dimensions: 265 x 270 x 550 mm

Weight: 12 kg

B0153 Engler Digital Viscometer, 2 specimens

Basically similar to the B0152 model but with room for 2 specimens.

Accessories and spare parts:

V1023 ASTM 23C thermometer, (range +18 to +28°C)

V1024 ASTM 24C thermometer, (range +39 to +54°C)

V1025 ASTM 25C thermometer, (range +95 to +105°C)

B0152/1 IP 76 C thermometer, (range +10 to +55 °C, div. 0.5 °C)

B0152/2 Kohlraush Distillation flask, capacity 200 mL

B0152/3 ASTM No. 50 sieve with mesh

B0152/3 Engler test flask, capacity 50 mL



B0170 Standard Digital Viscometer (TAR, BRTA)

Used to determine tar viscosity. The meter consists of a stainless steel bath with a stirrer, rheostat, electric immersion stirrer with a digital thermostat to keep the water at the desired temperature and a water supply coil.

Equipped with double safety thermostat to avoid overheating.

Supplied with an IP 8C glass thermometer (0-45 °C) and a graduated glass tube with a capacity of 100 mL.

The pass/no pass calibre and ball valve must be ordered separately (see accessories)

Power supply: 220 V 50/60 Hz - 300 W

Dimensions: 265 x 270 x 550 mm

Weight: 12 kg

B0171 Standard Digital Viscometer (TAR, BRTA), 2 specimens

Essentially similar to the B0170 model but with room for 2 specimens.

Accessories:

Standards EN, NF, IP

B0170/1 Pass/no pass calibre for
Ø 4 mm hole

B0170/2 Cup with Ø 4 mm hole

B0170/3 Ball valve for Ø 4 mm hole

Standards EN, NF, IP, BS

B0170/4 Pass/no pass calibre for
Ø 10 mm hole

B0170/5 Cup with Ø 10 mm hole

B0170/6 Ball valve for Ø 10 mm hole

Standards EN 12846

B0170/7 Pass/no pass calibre for
Ø 2 mm hole

B0170/8 Cup with Ø 2 mm hole

B0170/9 Ball valve for Ø 2 mm hole

Standards ASTM D88, D244 - AASHTO T72 - UNE 7066, 51021- NLT-133, 138



B0175 Saybolt Digital Viscometer

Used to measure viscosity in petroleum products at specific temperatures between 70 and 210 °F. Manufactured entirely from stainless steel and supplied complete with two interchangeable “Furol and Universal” holes, oil bath, electrical heater with a digital thermoregulator, stirrer, coil and viscosity flask.

Equipped with double safety thermostat to avoid overheating.

Power supply: 1 x 220V 50Hz 500W

Dimensions: 270 x 270 x 550 mm

Weight: 12 kg

B0176 Saybolt Digital Viscometer, 2 specimens

Basically similar to the B0175 model but with room for 2 specimens.

Accessories and spare parts:

- V1017** ASTM 17C, thermometer, (range +19 + 27 °C)
- V1018** ASTM 18C, thermometer, (range +34 + 42 °C)
- V1019** ASTM 19C, thermometer, (range +49 + 57 °C)
- V1020** ASTM 20C, thermometer, (range +57 + 65 °C)
- V1021** ASTM 21C, thermometer, (range +79 + 87 °C)
- V1022** ASTM 22C thermometer, (range +95 to +103 °C)
- B0175/4** Filter funnel with mesh and clamp
- B0175/5** Complete extractor tube
- B0175/1** Interchangeable Furol nozzle
- B0175/2** Interchangeable Universal nozzle
- B0175/3** Saybolt flask, capacity 60 mL



Standards EN 22719 – ASTM D93 – AASHTO T73, IP 34, 35 – ISO 2719

B0158 Digital Pensky-Martens Viscometer

Used to determine the flash point of petroleum products by the closed beaker method, for flash points between 40 and 360 °C.

Supplied complete with stirrer, radiation housing, cast iron air bath, electric heating with digital thermoregulator and two ASTM 9C (-5 +110 °C) and ASTM 10C (+90 +370 °C) thermometers

Power supply: 1 x 220V 50Hz 600W

Dimensions: 200 x 300 x 500 mm

Weight: 6 kg





Standards NLT 197

B0178 Saybolt viscometer for high temperatures

Features similar to those of the **B0175** model except that it is designed to perform tests on asphalt materials at a temperature range between + 125 °F and + 450 °F. Supplied with Furol hole, digital temperature thermometer, heating element, stirrer and cooling device.

Power supply: 220 V 50 Hz 600 W

Dimensions: 550 x 350 x 350 mm

Weight: 16 kg

Accessories:

B0175/1 Furol nozzle.

B0175/2 Standard nozzle.

Standards UNE EN 13302; NLT 375; ASTM D3205, 4402; CEN TC 19

B0180 Rotating viscometer

To determine the viscosity of asphalt bitumens. Apparatus controlled by a microprocessor that guarantees viscosity measurement reproducibility and precision of $\pm 1\%$. The equipment has a total of 19 speeds adjustable between 0.3 and 200 rpm. The adjustable digital display screen shows the selected speed (rpm), the spindle chosen (SP), viscosity reading (CP) and the full scale proportion (%). Supplied complete with a support, 4 spindles, protector, base plate with bosshead, carrying bag and instruction manual.

Accessories:

B0180/1 Low viscosity adaptor.

B0180/2 Small sample adaptor.

B0180/3 Temperature controller.

B0180/4 Helicoidal motor movement.

B0180/5 Base plate.

B0180/6 Spindle.

B0180/7 Spindle protector.

B0180/8 Standard calibration oil.



Standards NLT 183; ASTM D139; AASHTO T50

B0183 Float tester

To determine the consistency of bituminous materials. The float tester consists of an aluminium cup with a threaded hole at the bottom and a truncated-cone collar for airtight adjustment to the floater hole.

Cup Dimensions: $\varnothing 92 \times 35$ mm

Hole: $\varnothing 11.1$ mm



Ductility and rupture point

Ductility is the measurement of bitumen resistance to ductility. This method can be used as part of a series of classification tests to determine bitumen properties.

The rupture point is important in countries with very low winter temperatures. The test measures the capacity of bitumen under load to resist low temperatures without cracking.

Standards UNE EN 13589; 13398; NLT 126; UNE 7093; ASTM D113; AASHTO T51; CNR N.44 PR-EN

B0190 Ductilometer



Used to determine bitumen ductility, that is, the distance that a bituminous specimen can be stretched under controlled thermostatic conditions before it ruptures. The ductilometer consists principally of a moving carriage that slides along guide rails. The carriage is driven by an electric motor housed inside a thermostatic stainless steel bath, fitted with heating elements, a thermostat and a pump. The equipment performs the test automatically at a speed of 50 mm/min and can work with 3 specimens simultaneously.

Usable travel: 1500 mm

Power supply: 220 V 50 Hz - 1000 W

Weight: 95 kg

Dimensions: 2140 x 350 x 400 mm

Accessories:

B0190/1 Mould in "8" shape for preparation of specimens.

B0190/2 Mould base plate.

B0190/3 Complete cooling system for tests at temperatures of + 5 °C



Standards UNE EN 12593; NLT 182; CNR IP-80; DIN 5201

B0195 FRAAS Apparatus

To determine the breaking point of solid or semi-solid bituminous materials. The equipment consists of a bending system with two concentric displacement glass tubes, a grip for the test sample, a lever-activated bending system, cooling unit, sheet of special steel and an IP 42C thermometer for - 38 + 30 °C.

Spares:

B0195/1 Test sheet made of special steel.

Standards UNE EN 13398; NLT 329

Ductility and rupture point

B0200 Torsion meter, to determine the degree of elasticity of modified asphalt bitumens used in road construction. The equipment consists essentially of a metal cylinder $\varnothing 25.4 \times 100$ mm long, a semi-crown with a graduated scale from 0 to 180° , water bath and container for the sample.



Standards UNE EN 1430; NLT 194; ASTM D 244; AASHTO T59

Ductility and rupture point

B0205 Equipment to determine the particle load in bituminous emulsions, consisting of an electrically powered device at direct current of 12 V, provided with a milliammeter with adjustable heating element and electrodes.

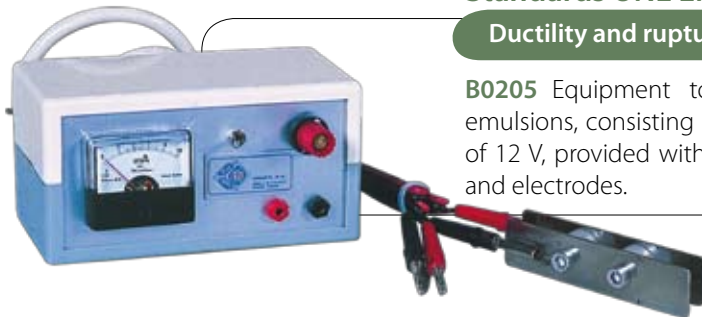

Temperature

The temperature is one of the most important aspects in any construction project that involves the laying of asphalt or concrete.

Thermometers

B0210 Bimetal analogue thermometer, especially designed to measure asphalt temperature.

Measurement range: $0 - 200 \pm 2^\circ\text{C}$

Bulb dimensions: $\varnothing 4 \times 200$ mm

B0211 Bimetal digital thermometer, especially designed to measure asphalt temperature.

Measurement range: $-50 + 250 \pm 1^\circ\text{C}$

Bulb dimensions: $\varnothing 4 \times 200$ mm

V0153 Portable digital thermometer, designed for fast, accurate temperature measurements. With a "Hold" key to retain the measurement.

Measurement range: $-50 + 1000^\circ\text{C}$

Resolution: 0.1°C

Conversion: $^\circ\text{C} / ^\circ\text{F}$

Dimensions: $190 \times 57 \times 42$ mm

Weight: 300 g

Accessories:

V0153/1 Immersion/penetration probe

V0153/2 Surface probe

V0153/3 Dust protection cover



Density - Nuclear method

The new MC-3 Portaprobe is the most accurate, tough and easy to use equipment on the market to measure density and humidity.

Standards ASTM D6938; D2922; D2950; D3017; BS 1377

Density - Nuclear method



Characteristics:

- Automatic depth detection
- Light, portable and accurate
- Double position for backscattering work
- Rechargeable batteries
- Integrated microprocessor to simplify functions
- Simultaneous on-screen display of all measured parameters
- Option of selecting test time and accuracy
- Storage capacity for 128 readings of all data
- RS232C port to upload data to a printer or PC
- Real time clock and calendar

Simple operation

The operator starts the test by pushing the START key... In less than a minute, the 160 character display shows all the results simultaneously. The following data appear on the screen in English or metric units:

- Wet density.
- Dry density.
- Humidity content.
- Humidity percentage.
- Compaction percentage.
- Percentage volume of voids.
- Statistical calculation of precision.

To measure pavement density, place the equipment on the surface to be tested, making sure it is smooth and free from voids. Use the double backscattering position to obtain precise density measurements at 52.1 or 71.1 mm. Measurement depth = 95 % of backscattering range. The MC-3 measures compaction of tread layers from 25 to 76.2 mm thick, correcting the influence of the bottom layer. To measure soil compaction, a small hole is made in the ground with a pickaxe and the equipment is placed over it. By lowering the power source into the hole, density measurements can be taken at increments of 1 or 2 inches (25 or 50 mm), to a depth of 8 or 12 inches. (200 or 300 mm). The humidity measurements are performed on the surface. The measurement depth varies between 4 and 8 inches (100 or 200 mm), with no need to make a hole or prepare the test surface.

Precision

A precision instrument for one-minute tests, with wet density 2.0 gcc and 0.16 gcc humidity:

Backscattering: ± 0.008 gcc (± 0.50 pcf)

Direct transmission: ± 0.004 gcc (± 0.25 pcf)

Humidity: 0.004 gcc (± 0.25 pcf)

Density - Nuclear method

Operations

Function: onsite measurement of density and humidity.

Range: Density 1.120 to 2.730 gcc - Humidity: 0 at 0.708 gcc.

Test time: user-selected.

Operating temperature: from 0 to 60 °C (32 to 140°).

Power supply: 8 rechargeable Ni/Cd batteries.

Battery duration: 500-100 charge/discharge cycles.

Consumption: 10 mA. Allows 600 tests of one minute.

Recharge: 14 hours.

Screen: LCD 160 characters.

Units: user-selected gcc, pcf or cpm.

Storage capacity: up to 128 tests. Optional upload to a PC via RS232C.

X-rays

Gamma source: 10 mCi (370 MBq) Cesium-137.

Neutron source: 50 m Ci (18 50 M Bq) Americium-24 1 /Be.

Encapsulation: double encapsulated sources, CPN 131.

Dose rate at handle: under 0.5 mR/h (5 microSv/h).

Packaging: radioactive material in special form N.O.S., UN3332.

Transport ratio: 0.4 Category II Yellow - Type A package.

Special form certificates: USA/0627/S, USA/0634/S

Base equipment

Supplied complete, including high density polyethylene bag, lock and keys, tar block, base plate, pickaxe, work tablet, lubricant, signal kit and airtight conditions certificate.



Models:

- S0475/MC-3-82** Portaprobe, Density/Humidity meter for tests up to 200 mm deep with increments of 50 mm
- S0476/MC-3-81** Portaprobe, Density/Humidity meter for tests up to 200 mm deep with increments of 25 mm
- S0480/MC-3-122** Portaprobe, Density/Humidity meter for tests up to 300 mm deep with increments of 50 mm
- S0481/MC-3-121** Portaprobe, Density/Humidity meter for tests up to 300 mm deep with increments of 25 mm

Standards ASTM D6938; D2922; D2950; D3017; BS 1377

Density – Nuclear method – MC – 1 – DRP

Portable equipment for fast, accurate measurements of density/humidity in construction materials, to check compaction. In compliance with ASTM D6938, D2922 and D3017 for soils, and ASTM D2950 for asphalts. The equipment gives the following results directly.

- Wet density.**
- Dry density.**
- Humidity content.**
- Humidity percentage.**
- Compaction percentage.**
- Percentage volume of voids.**

Measures pavement density
Measures soil compaction
Measures surface humidity



X-rays

- Gamma source:** 10 mCi (370 MBq) Cesium137.
- Neutron source:** 50 mCi (1850 MBq) Americium-241/Be.
- Encapsulation:** double encapsulated sources, CPN 131.
- Dose rate at handle:** under 0.5 mR/h (5 microSv/h).
- Packaging:** radioactive material in special form N.O.S., UN3332.
- Transport Index:** 0.4 Category II Yellow. Type A package.
- Special form certificates:** USA/0627/S, USA/0634/S

Base equipment

Supplied complete, including high density polyethylene bag, lock and keys, tar block, base plate, pickaxe, work tablet, lubricant, signal kit and airtight conditions certificate.

Models:

- S0485/MC-1DR-82** Portaprobe, Density/Humidity meter for tests up to 200 mm deep with increments of 50 mm
- S0486/MC-1DR-81** Portaprobe, Density/Humidity meter for tests up to 200 mm deep with increments of 25 mm
- S0487/MC-1DR-122** Portaprobe, Density/Humidity meter for tests up to 300 mm deep with increments of 50 mm
- S0488/MC-1DR-121** Portaprobe, Density/Humidity meter for tests up to 300 mm deep with increments of 25 mm



Standards TP 68-04; ASTM D 7113-05

Aggregate Density – Non-nuclear Method

B0060 Pavement temperature and density meter.

The PQI 301 device is an instrument designed to take fast and accurate readings of hot asphalt during the compaction process. After a test lasting only three seconds, it shows the density and temperature of the tested asphalt. If the readings are taken during the spreading process, it does not interfere in the process due to the speed involved.

Operation specifications

There are four working modes:

Continuous mode: in this mode the equipment measures the density continuously and shows the following data on screen in real time: density, temperature and % of compaction or volume of voids.

Simple mode: performs a three second test and displays: density, temperature and % of compaction or volume of voids.

Mean mode: takes five readings and shows the mean.

Segregation mode: After a series of tests the equipment identifies variations in density due to segregations and shows the maximum, minimum and mean density values.

Functions:

Density measurement, compaction %, void volume % and segregation.

Temperature measurement in real time. Range from $-17.7\text{ }^{\circ}\text{C}$ to $177.6\text{ }^{\circ}\text{C}$.



Selection of "layer to layer" depth measurement from 12 mm to 125 mm
Measures temperature in centigrade degrees from $-17.7\text{ }^{\circ}\text{C}$ to $177.6\text{ }^{\circ}\text{C}$

Accessories:

B0060/1 Printer

B0060/2 Verification block

Sample extraction

The most direct method to evaluate construction materials such as aggregates is to take a sample of the areas to test. The simplest and fastest way to obtain samples with adequate size and quality is with a sample-removal probe.



H0138 Electric sample extractor probe

Three speeds, 360° adjustable so user can work at any angle. The base is steel and supports a column with an adjustable anchoring device. The machine includes two wheels that make it extremely manageable and four legs for lifting and positioning. The column includes a guide required both for advancing the motor/drill bit unit and to remove the unit, whose movements are controlled by a crank. The motor incorporates a fast plug system to cool the drill bit. The vertical column can take extensions to work to a depth of up to 2.7 m.

Power supply: 220-240 V. 50 Hz

Power absorbed : 2000 W

Dimensions: 700 x 450 x 1200 mm

Weight: 100 kg

H0139 Portable sample extraction probe

For road pavement, powered by a 4 stroke gas combustion engine. The machine head slides with the help of a wheel along the two columns. Includes a water cooling unit.

Motor power 5 Hp

Drill bit connection: 1 1/4"

Dimensions: 800 x 450 x 940 mm

Weight: 150 kg

Accessories:

H0140 Special cart designed for onsite transport of the probe.

Includes a water tank for cooling.

H0141 Diamond drill bit Ø 50 x 350 mm

H0142 Diamond drill bit Ø 75 x 350 mm

H0143 Diamond drill bit Ø 100 x 350 mm

H0144 Diamond drill bit Ø 150 x 350 mm

H0145 Diamond drill bit Ø 200 x 350 mm

H0146 Extension, 500 mm long.



Pavement tests

Standards UNE 13036-7

Surface irregularity

The rapid increase of traffic density all over the world has made effectiveness of vehicle control vitally important. Braking efficiency is especially important, and this depends a great deal on the quality of the road surface.

B0220 Mobile ruler approximately 3 m long to measure road irregularities. Made of aluminium alloy. Two graduated wedges are used together.

Accessory:

B0220/1 Graduated wedge.

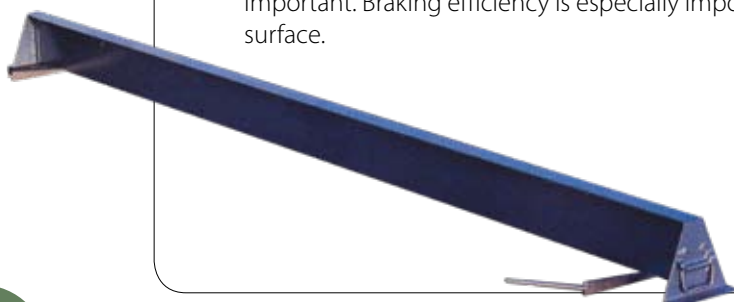

B0221 Mobile beam equipment

Used to detect irregularities in road surfaces, both in bituminous compounds and concretes. The equipment is made up of a beam with wheels on the ends and centre. The middle wheels detect any vertical deviation over the hypothetical straight line between the wheels on the ends. The vertical deviations are transmitted from the mobile centre wheel to one end with a scale visible to the operator. Supplied complete with a spray to mark the defective parts of the road.



Length: 3000 mm

Maximum detectable deviation: ± 25 mm

Division: 2 mm

Accessories:

B0221/1 Recorder to use with the ruler, complete with 10 rolls of recording paper and 10 pen nibs.

B0221/2 Rolls of recording paper (10 units).

B0221/3 Pen nibs (10 units).

Standards NLT 356; AASHTO T256: S.N.V.

B0222 Benkelman beam

To measure the deflection of flexible pavement under loads from moving wheels. The beam is placed between the treads of the vehicle and in contact with the pavement. Deflection is measured when the vehicle passes through the test zone. Built entirely from aluminium.

Length: 2500 mm

Weight: 15 kg

Accessories:

B0222/1 Wooden carrying case.

B0222/2 Calibration device.

B0225 Load plate equipment with a capacity of 100 kN, to be used together with the Benkelman Beam to measure deflection in the centre of the plate from a point of reference not affected by the load. Supplied complete with a load plate measuring $\varnothing 300$ mm, central measuring device, hydraulic 100 kN jack complete with a manual pump, graduated manometer (0 - 100 kN), a set of extensions, ball joints, test accessories and carrier case.

Weight: 75 kg

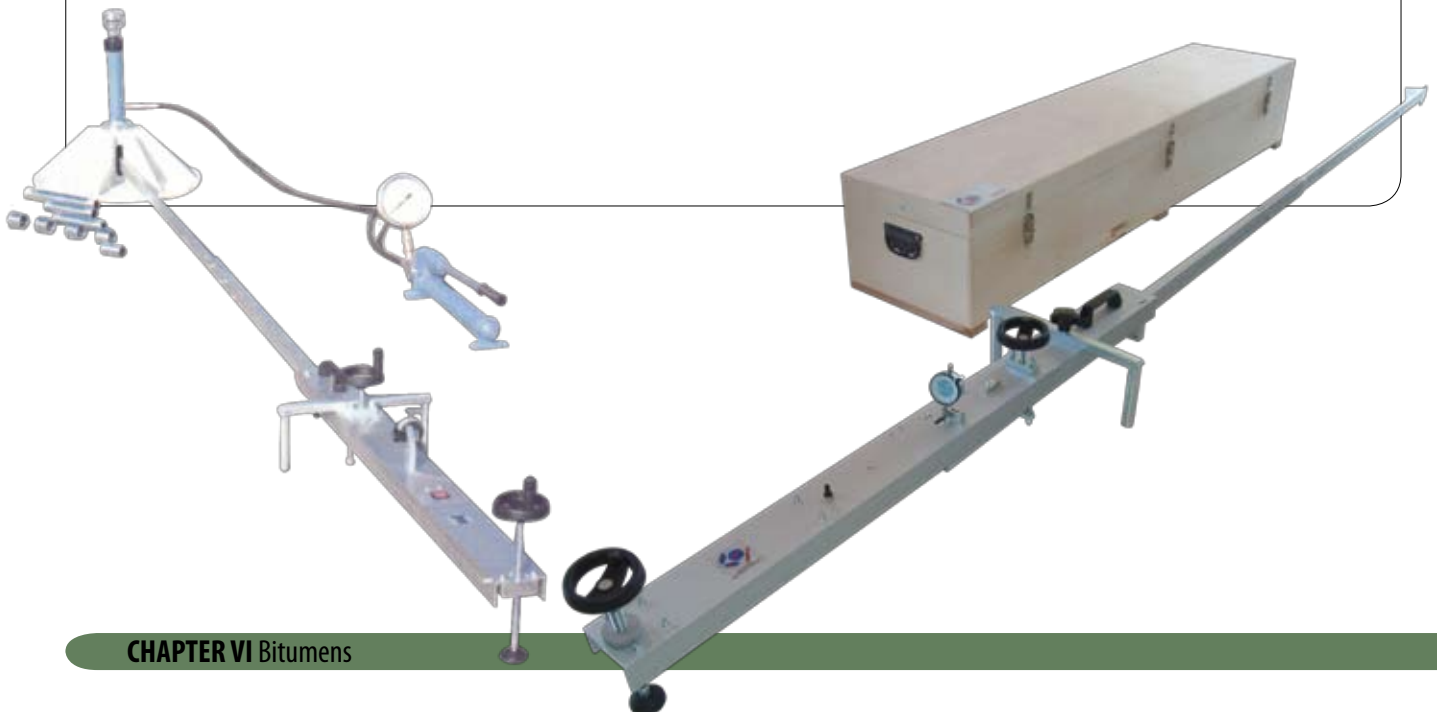

Measuring skid resistance on roads - Gryptester

B0250 Equipment for measuring skid resistance

A flexible, accurate and economical way to measure skid resistance on roads, highways and at airports.

The skid resistance equipment consists of a three-wheeled trailer that measures friction by means of a fourth wheel which has a brake, the principle of fixed skidding. The single measuring wheel is provided with a special smooth tread tyre that is mounted on an instrumented shaft to measure both the horizontal drag and vertical load. These measurements are used to automatically calculate the dynamic friction reading that is transmitted to the data collection computer normally found inside the trailer. This computer also calculates and saves the testing speed for each reading.

Main features

Inexpensive, reliable, sturdy and easy to maintain.

Excellent repeatability and reproducibility

The readings are not affected by curves in the road.

Suitable for any kind of road.

Easy to deploy and transport - can be hitched to a wide range of vehicles.

80 km of tests with a 500 litre tank.

SCRIM correlation

Easy integration of data with any SPM.



Technical characteristics

Length: 1010 mm (excluding the trailer bar)

Width: 790 mm

Height: 510 mm

Weight: 85 kg

Measuring wheel (1): Smooth texture as per ASTM

Wheel (2): KT3-W tread, K8-CIK Rubber

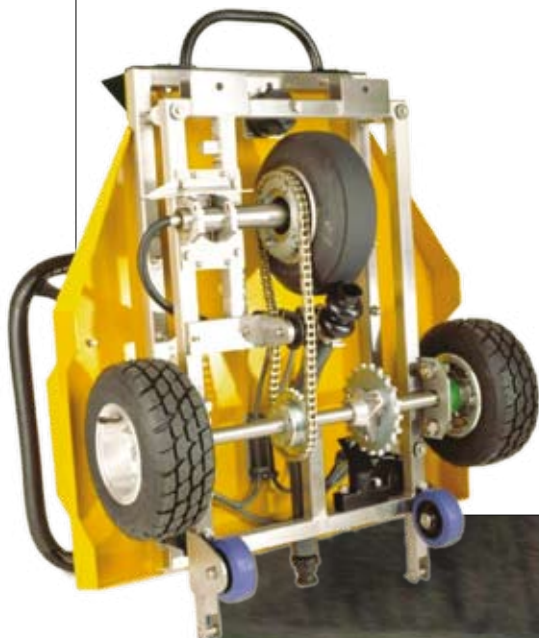

Texture

Pavement surface texture is an important aspect of road surface safety. For vehicles at high speeds, the surface texture must be good, facilitate water drainage from the road surface and use the tyre tread to absorb the kinetic energy of the vehicle.

Standards NLT 335; ASTM E965; BS 598: Part 105

Texture

Measurement of pavement surface texture using the sand circle method. The test is performed by expanding a pre-established volume of fine sand over a circular surface of the road, completely filling the cavities of the asphalt layer. The ratio of the surface area used for the test and the volume of sand is then calculated.

B0230 Equipment for the sand circle test, consisting of three graduated cylinders of 50, 25 and 10 mL respectively, a rubber-coated disc to spread the sand, a rigid point compass, a ruler, two 2L containers, a soft hair brush, a wind breaker and a portable gas burner.

Standards UNE EN 12272-1; BS 594

Percentage of coat spread

B0237 Calibrated spring scale, complete with tray, chain and spring scale. The percentage of spread is read directly on the graduated scale display.

Weight: 1 kg



Mean coat thickness

A non-destructive method is frequently needed to measure the thickness of bitumen and other non-magnetic materials

B0240 Thickness meter

To measure the thickness of bitumen coating and other non-magnetic materials on a ferrous base. Supplied in a protective cover.

Accuracy: $\pm 5\%$ of the reading.

Dimensions: 90 x 50 x 25 mm

Weight: 200 g

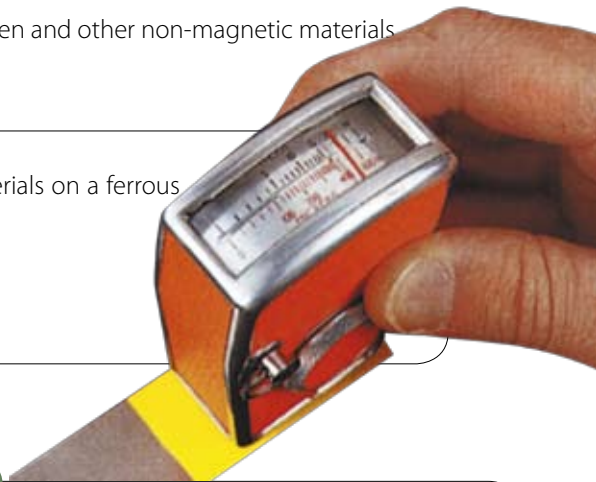

Standards NLT - 327

Permeability

Onsite permeability of draining pavement with the LCS permeameter.

B0245 LCS permeameter to measure a fixed amount of water passing through a bituminous mix in seconds. The device consists of a transparent, graduated, cylindrical tube measuring $\varnothing 94 \times 500$ mm high placed on a special base, a counterweight of 20 kg with handles and a circular rubber ring 16 mm thick.

Dimensions: 200 x 200 x 700 mm

Weight: 25 kg

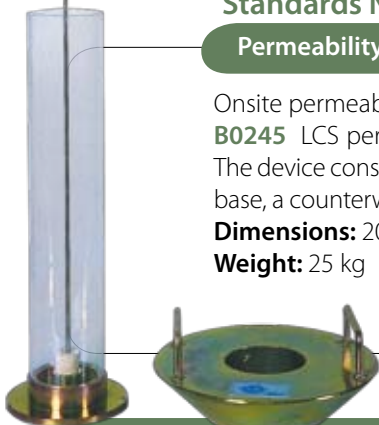



Notes

=====

Lined area for taking notes, consisting of 30 horizontal lines.

7

STEEL

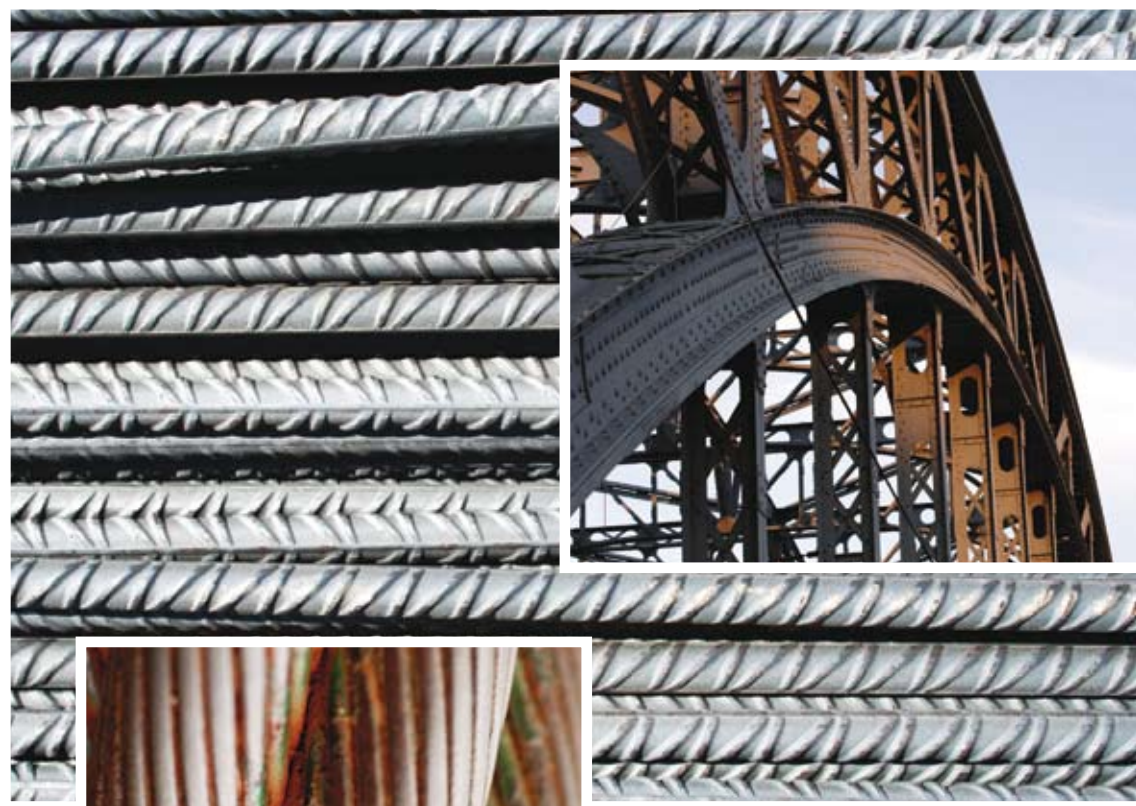

Computerised universal testing machines

EN 10002-1; DIN 50.125 and UNE 7184

Servo-hydraulic universal testing machines

The servo-hydraulic testing machines of the DI-CP series are designed to perform tests on both metallic and non-metallic materials: tensile, compression and bending.

Key features:

Class 0.5 or 1.0 as specified in ISO 7500

Complete computerised control by PC

Software

Automatic calculation of results, statistics, testing graphs, curve comparison and so on.

Servo-control for closed loop load (kN/s), elongation (mm/min) and tensile [(mm/min)/min] testing.

The testing frame incorporates the following advantages:

Reduced height

No need for a hole under the machine.

The tensile test areas are located between 800 and 1800 mm from the floor.

The compression/bending test area can be set at a working height between 1600 and 2000 mm.

The machine can be placed at a minimum height of 3300 mm, making it easier to transport and to move around and start up in the laboratory.

The computer performs closed loop control of the various test parameters (load, displacement and deformation) and permits tests to be carried out at constant increases of any of these physical parameters.

The control file is organised as a series of steps (up to 10) to make it easier for the user to generate simple or complex control files or to link several steps together to obtain repeating test sequences.

The program also has a control option that allows the user to modify the speed and limits in the file, even during the test itself.

Test-generated data can be examined in separate files, or exported in ASCII format for processing in other programs or databases, so that the output can easily be adapted to the user's needs.



DI-CP/V2 Load frame

A testing frame with four columns and two testing areas: the main testing area for tensile tests and the secondary area for compression, bending and punch tests, etc. The tensile tests are carried out in the lower part, while the compression tests are performed in the upper part, between the top cross-head and the bending device (optional).

Spring return piston, with a 300 mm stroke.
 Manual or automatic top cross-head adjustment.
 Hydraulic locking/unlocking system
 Measurement system: pressure transducer with temperature compensation.
 Equipment provided with a set of plates and grips with a set of wedges
 Available load capacity (standard program): 400 kN; 600 kN; 1000 kN and 2000 kN.
 Other load capacities available on request

Hydraulic group

The hydraulic group is equipped with a servo-control device for automatic computer-managed load adjustment. The group is equipped with an emergency button for immediate servo-control unloading, in compliance with EC safety standards.

Hydraulic oil used to lift the actuator. This movement will provide a compression load in the upper testing area and tensile load in the lower testing area. The hydraulic actuator is of the gravity-driven return type. The unit consists of the piston, compression area, columns and tensile cross-head. These move in unison as though they were a single piece of equipment. The top cross-head is adjustable and remains fixed during the test.

Accessories



Grips made of hardened steel for perfect self-tightening of test samples.
 A threaded device anchors and locks the test specimen in place.
 Compression plates: a set of top and bottom plates, made of steel alloy, heat treated for extra hardness.
 Bending device (optional), consisting of two lower rollers with an adjustable support and a top roller.



Control and measurement system

The electronic measuring equipment (CV) is included in a 19" rack cabinet with the computer, screen and printer, as well as the electronic CPC model. The electronics cabinet is linked to the machine's transducers and to the electrical panel via a number of connectors. This electronic equipment conditions the transducer load and displacement signals and also controls test speeds.

The following items are included in the cabinet:

- Load/Deformation amplifier module with automatic scales and an encoder module.
- Analogue input/output, digital input/output card, 16 relays, multiplexer and computer bus connection.
- Control buttons and signal lights.

Hardware

- Computer
- Monitor with SVGA-COLOUR card, two serial and one parallel port
- Microsoft compatible mouse and keyboard
- WINDOWS XP PRO
- HP DESKJET COLOUR printer

Available Models:

SPECIFICATIONS	400 kN	600 kN	1000 kN	2000 kN
Model	E0001	E0002	E0003	E0004
No. of columns	4			
Machine type	servo-hydraulic			
Piston stroke (mm)	300			
Test speed (mm/min)	0 - 120		0 - 100	0-75
Control	Automatic (PC)			
Travel (mm)	650		900	
Drive	motor-driven			
Approach speed (mm/min)	250			100
Column spacing in tensile area (mm)	545		675	890
Distance between grips (mm)	50 - 950		50 - 1200	
Distance between grips (mm)	348		442	500
Distance between plates (mm)	0 - 320			
Compression plate diameter (mm)	160			200
Testing frame (dimensions and weight)				
Height – grips in contact (mm)	3000		3300	3500
Height – piston retracted (mm)	3800		4500	4600
Width (mm)	1000		1200	1300
Depth (mm)	660		750	900
Weight (kg)	5000		7000	7200
Desk measurements (mm)	1970 x 570 x 600			
Power supply	3ph 380/200 V. 50 Hz. 3000 W			
Calibration Certificate	ENAC			

E0001 Computerised universal testing machine, 400 kN capacity

Consists of a DI-CPC/V2 rack with 400 kN capacity and the following test tools:

- Set of hydraulic powered tensile grips, including:
- Set of wedges for round specimens of between 8 and 20 mm.
- Set of wedges for flat specimens of between 0 and 15 mm.
- Set of compression plates of Ø140 mm.
- Electronic extensometer EXM-1002
- PC control and measurement cabinet (computer, monitor, keyboard, mouse and printer)
- Software running under Windows with metal-testing program and interface card
- Hydraulic group (Servo-valve MOOG)
- ENAC official calibration certificate
- Instruction manual

E0002 Computerised universal testing machine, 600 kN capacity

Consists of a DI-CPC/V2 rack with 600 kN capacity and the following test tools:

- Set of hydraulic activated tensile grips, including:
- Set of wedges for round specimens of between 6 and 20 mm.
- Set of wedges for flat specimens of between 0 and 24 mm.
- Set of compression plates of Ø160 mm.
- Electronic extensometer EXM-1002
- PC control and measurement cabinet (computer, monitor, keyboard, mouse and printer)
- Software running under Windows with metal-testing program and interface card
- Hydraulic group (Servo-valve MOOG)
- ENAC official calibration certificate
- Instruction manual

E0003 Computerised universal testing machine, 1000 kN capacity

Consists of a DI-CPC/V2 rack with 1000 kN capacity and the following test tools:

- Set of hydraulic activated tensile grips, including:
- Set of wedges for round specimens of between 8 and 28 mm.
- Set of wedges for flat specimens of between 0 and 25 mm.
- Set of compression plates of Ø160 mm.
- Electronic extensometer EXM-1002
- PC control and measurement cabinet (computer, monitor, keyboard, mouse and printer)
- Software running under Windows with metal-testing program and interface card
- Hydraulic group (Servo-valve MOOG)
- ENAC official calibration certificate
- Instruction manual

E0004 Computerised universal testing machine, 2000 kN capacity

Consists of a DI-CPC/V2 rack with 2000 kN capacity and the following test tools:

- Set of hydraulic activated tensile grips, including:
- Set of wedges for round specimens of between 8 and 35 mm.
- Set of wedges for flat specimens of between 0 and 25 mm.
- Set of compression plates of Ø160 mm.
- Electronic extensometer EXM-1002
- PC control and measurement cabinet (computer, monitor, keyboard, mouse and printer)
- Software running under Windows with metal-testing program and interface card
- Hydraulic group (Servo-valve MOOG)
- ENAC official calibration certificate
- Instruction manual

NOTE: A minimum surface area of 2 m² is required for the installation of any of these models. Floor anchoring is not necessary. The models are equipped with adjustable legs for perfect alignment and stability. The electrical connection requires two mains connections, one three-phase and another single phase. Please contact us regarding countries with other electrical supply characteristics.

Extensometer (deformation transducer)

For accurate measurement of elastic limits as per tensile metal specimen standards, and for measurement of Elastic Modulus E for metals, consisting of:

Extensometric gauge transducer: HBM, mod. DD1

Initial length: 50 mm.

Measuring capacity: (deformation in %) $dL=2$ mm. (4 %)

Supplied complete with amplifier (2 mV/V).

Reading is carried out directly on the PC.

Clamp extensometers	E0022	E0022/1
Extensometric gauge transducer	HBM, mod. DD1 HBM	HBM, mod. DD1 HBM
Initial length	$L_0 = 50$ mm	$L_0 = 50$ mm
Deformation measuring capacity (% of deformation)	$dL = 2$ mm (4 %)	$dL = 2$ mm (2 %)

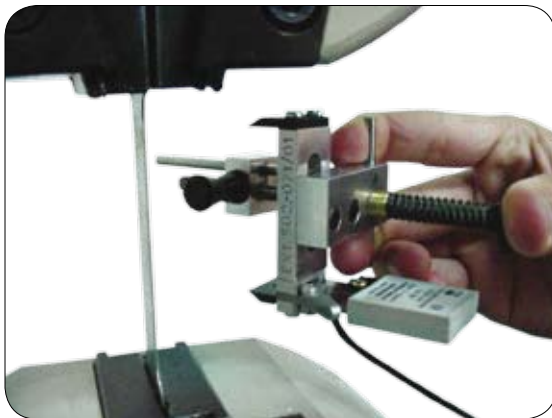

E0022 EXT-502/35 extensometer for diameters up to 35 mm.

E0022/1 EXT-502/100 extensometer for diameters up to 100 mm.

Accessories:

E0024 Folding/bending cross-head with rollers, for machines with 400/600 kN capacity.

Length: 500 mm.

E0024/1 Folding/bending cross-head with rollers, for machines with 1000/2000 kN capacity.

Length: 500 mm.

E0026 Device for testing removal of electrowelded wire mesh.

Computerised universal testing machines

EN 10002-1; DIN 50.125 and UNE 7184

Servo-hydraulic universal testing machines (DI-CP/S series rack)

The servo-hydraulic testing machines of the DI-CP series are designed to perform tests on both metallic and non-metallic materials: tensile, compression and optional bending tests.



DI-CP/S series racks have the following advantages:

The lower grip head is fixed and at a low level.

Two column-threaded spindle approach system.

No need for any hole under the machine.

The testing areas are located between 1000 and 1800 mm from the floor.

The computer performs closed loop control of the various test parameters (load, displacement and deformation) and permits tests to be carried out at constant increase of any of these physical parameters.

The control file is organised as a series of steps (up to 10) to make it easier for the user to generate simple or complex control files or to link several steps together to obtain repeating test sequences.

The programme also has a control option that allows the user to modify the speed and limits in the file, even during the test itself.

Test-generated data can be examined in separate files, or exported in ASCII format for processing in other programs or databases (ACCESS), where the

user can adapt the information to create special reports, queries, statistics and so on.

The control and adjustment electronics are installed in a cutting-edge computer on a wooden table especially designed so the operator can control the entire test from that position.

Digital display of displacement / deformation forces directly on the computer.

Class 1 accuracy (better than 1% from the 10 % scale)

Hydraulic group, air cooled, with MOOG servo-valve, electrical panel, hydraulic pressure hoses and grips.



Servo-control (SV)

Close loop computer control of MOOG servo-valve to control load speeds (N/s, Mpa/s), forward movement (mm/min) or deformation (microns/s)

Grips

Hydraulic powered tensile grip heads with manual pushbuttons and separate pressure control. These include a set of wedges for flat specimens of up to 50 mm thick and a set for round specimens with diameters between 8 and 55 mm.

Data control and processing by PROETI computer (CPC)

Control software for testing machines running under Windows. Includes the metal testing program, the interface card, cables and calibration. The files are personalised for each user.

- Hardware
- Computer
- Monitor with SVGA-COLOUR card
- Two serial ports, one parallel port
- Microsoft compatible mouse and keyboard
- WINDOWS XP PRO
- HP DESKJET COLOUR printer

Available Models

SPECIFICATIONS	600 kN	1000 kN
Model	E0054	E0055
No. of columns	4	
Machine type	servo-hydraulic	
Piston stroke (mm)	300	
Test speed (mm/min)	0-120	
Control	Automatic (PC)	
Travel (mm)	0- 650	
Drive	motor-driven	
Approach speed (mm/min)	600	
Column spacing in tensile area (mm)	530	
Distance between grips (mm)	0-900	
Distance between compression area	340	
Distance between plates (mm)	0-450	
Compression plate diameter (mm)	160	
Testing frame (dimensions and weight)		
Height – grips in contact (mm)	2865	3165
Height – piston out (mm)	3200	3500
Width (mm)	900	900
Depth (mm)	850	850
Weight (kg)	2000	2500
Desk dimensions (mm)	850 x 520 x 1300/1800 with monitor	
Power supply	3ph 380/200 V. 50 Hz. 3000 W	
Calibration Certificate	ENAC	



E0054 Computerised universal testing machine, 600 kN capacity

Consists of a DI-CP/S rack with 600 kN capacity and the following test tools:
 Set of hydraulic powered tensile grips, including:
 Set of wedges for round specimens of between 8 and 55 mm.
 Set of wedges for flat specimens of between 0 and 50 mm.
 Set of compression plates of Ø160 mm.
 PC control and measurement cabinet (computer, monitor, keyboard, mouse and printer)
 Software running under Windows with metal-testing program and interface card
 Hydraulic group (Servo-valve MOOG)
 ENAC official calibration certificate
 Instruction manual

E0055 Computerised universal testing machine, 1000 kN capacity

Consists of a DI-CP/S rack with 1000 kN capacity and the following test tools:
 Set of hydraulic activated tensile grips, including:
 Set of wedges for round specimens of between 8 and 55 mm.
 Set of wedges for flat specimens of between 0 and 50 mm.
 Set of compression plates of Ø160 mm.
 PC control and measurement cabinet (computer, monitor, keyboard, mouse and printer)
 Software running under Windows with metal-testing program and interface card
 Hydraulic group (Servo-valve MOOG)
 ENAC official calibration certificate
 Instruction manual

NOTE: A minimum surface area of 2 m² is required for the installation of any of these models.
 Floor anchoring is not necessary.
 The models are equipped with adjustable legs for perfect alignment and stability.
 The electrical connection requires two mains connections, one three-phase and another single phase
 Please contact us regarding countries with other electrical supply characteristics.

Accessories

E0024 Folding/bending cross-head with rollers, for machines with 400/600 kN capacity.
Length: 500 mm.
E0024/1 Folding/bending cross-head with rollers, for machines with 1000/2000 kN capacity.
Length: 500 mm.
E0026 Device for testing removal of electrowelded wire mesh.
E0022 EXT-502/35 extensometer for diameters up to 35 mm.
E0022/1 EXT-502/100 extensometer for diameters up to 100 mm.

Computerised universal testing machines

Electro-mechanical universal testing machines

This machine consists of a load frame with a base plate, two guide-columns made of ground, tempered steel and a top cross-head plate. Provided with two threaded spindles between which the cross-bar moves. Powered by an electro-mechanical direct current servo-motor and two recirculating ball screw spindles, all of which guarantees smooth operation and constant speed during tests. Small supporting base that contains the motor, gearbox and spindle transmission, as well as the servo-motor control electronics. Two test areas (upper and lower) that are equally ready for the application of tensile or compression loads.

Universal load cell (tensile/compression) mounted on the mobile cross-bar for measuring loads in the test area.

Easy assembly of all test tools (tensile, compression, bending or folding, etc.) in both test areas.

A robustly designed base plate with the option of three inverted T grooves, (GROOVED BASE PLATE), for easy attachment of special tools other than the standard attachments.

The base plate is commonly used to mount the accessory elements for folding, bottom compression plate and so on. In this case the tensile grips are installed in the upper area. They can also be installed in the lower area if more convenient to use the machine in that manner.

There is no need for movement of intermediate crossbars because it is already motorised throughout its travel.

The spindle is protected electrically by a system of adjustable limiters with end-stops to limit travel to the pre-set maximum. These protection devices operate by stopping the machine's electric motor.



Electro-mechanical universal testing machines

Measurement Electronics

In desktop machines, these are included in a box attached to the rack, whereas in floor standing machines they are placed in a cabinet along with the computer, screen, printer and CPC electronics.

These electronics are used to process the load and displacement transducer signals, and to present the measurements on the two displays in digital form.

Extensometry is an option for accurate limit measurement.

The machine can be controlled manually by the CV/PC model speed control, or by the ETWIN program from the computer.

Control and measurement system

The electronic measuring equipment (CV) is included in a 19" rack cabinet with the computer, screen and printer, as well as the CPC model electronics.

The electronics cabinet is connected to the machine transducers and to the electrical panel via a number of connectors.

This electronic equipment processes the load and displacement transducer signals and also controls test speeds.

The following items are included in the cabinet:

Load/Deformation amplifier module with automatic scales and an encoder module.

Analogue input/output, digital input/output card, 16 relays, multiplexer and computer bus connection.

Control buttons and signal lights.

Hardware

Computer

Monitor (TFT screen).

Two serial ports, one parallel port

Microsoft compatible mouse and keyboard

WINDOWS XP Professional

HP DESKJET COLOUR printer

Grips made of hardened steel for perfect self-tightening of test samples.

A threaded spindle anchors and locks the test specimen in place.

Compression plates made from treated steel with heat-hardened surfaces.

Folding device (optional), consisting of two bottom rollers mounted on an adjustable support and an upper thrust piston.



Available Models

SPECIFICATIONS (kN)	5	10	20	50	100	200	300
TYPE	Desktop				Floor standing		
Model	E0010	E0011	E0012	E0013	E0014	E0015	E0016
Machine type	electro-mechanical						
Piston stroke (mm)	1000				1500		
Test speed (mm/min)	500					400	300
Control	Automatic (PC)						
Drive	motor-driven						
Attachment spacing (mm)	1000				1500		
Distance between grips (mm)	800		700		1150		1110
Distance between plates (mm)	885				1360		
Span between columns (mm)	430				475		
Compression plate diameter (mm)	100				140		
Height (mm)	1700				2700		
Width (mm)	1075				950		
Depth (mm)	550				660		
Desk dimensions (mm)	1970 x 570 x 600						
Power supply	3ph 380/200 V. 50 Hz. 3000 W						
Calibration Certificate	ENAC						

E0010 Computerised universal testing machine, 5 kN capacity

Consists of an HM-D rack with 5 kN capacity and the following test tools:

Set of lever operated tensile grips, including:

Set of wedges for round specimens of between 4 and 10 mm.

Set of wedges for flat specimens of between 0 and 8 mm.

Set of compression plates of Ø100 mm.

PC control and measurement (computer, monitor, keyboard, mouse and printer)

Software running under Windows with metal-testing program and interface card

ENAC official calibration certificate

Instruction manual

E0012 Computerised universal testing machine, 20 kN capacity

Consists of an HM-D rack with 20 kN capacity and the following test tools:

Set of lever operated tensile grips, including:

Set of wedges for round specimens of between 4 and 10 mm.

Set of wedges for flat specimens of between 0 and 8 mm.

Set of compression plates of Ø100 mm.

PC control and measurement (computer, monitor, keyboard, mouse and printer)

Software running under Windows with metal-testing program and interface card

ENAC official calibration certificate

Instruction manual

E0013 Computerised universal testing machine, 50 kN capacity

Consists of an HM-D rack with 50 kN capacity and the following test tools:

Set of lever operated tensile grips, including:

Set of wedges for round specimens of between 6 and 16 mm.

Set of wedges for flat specimens of between 0 and 12 mm.

Set of compression plates of Ø100 mm.

PC control and measurement (computer, monitor, keyboard, mouse and printer)

Software running under Windows with metal-testing program and interface card

ENAC official calibration certificate

Instruction manual

E0011 Computerised universal testing machine, 10 kN capacity

Consists of an HM-D rack with 10 kN capacity and the following test tools:

Set of lever operated tensile grips, including:

Set of wedges for round specimens of between 4 and 10 mm.

Set of wedges for flat specimens of between 0 and 8 mm.

Set of compression plates of Ø100 mm.

PC control and measurement (computer, monitor, keyboard, mouse and printer)

Software running under Windows with metal-testing program and interface card

ENAC official calibration certificate

Instruction manual

E0014 Computerised universal testing machine, 100 kN capacity

Consists of an HM-D rack with 100 kN capacity and the following test tools:

Set of lever operated tensile grips, including:

Set of wedges for round specimens of between 6 and 16 mm.

Set of wedges for flat specimens of between 0 and 12 mm.

Set of compression plates of $\text{Ø}100$ mm.

PC control and measurement (computer, monitor, keyboard, mouse and printer)

Software running under Windows with metal-testing program and interface card

ENAC official calibration certificate

Instruction manual

E0015 Computerised universal testing machine, 200 kN capacity

Consists of an HM-D rack with 200 kN capacity and the following test tools:

Set of lever operated tensile grips, including:

Set of wedges for round specimens of between 8 and 20 mm.

Set of wedges for flat specimens of between 0 and 15 mm.

Set of compression plates of $\text{Ø}140$ mm.

PC control and measurement (computer, monitor, keyboard, mouse and printer)

Software running under Windows with metal-testing program and interface card

ENAC official calibration certificate

Instruction manual

E0016 Computerised universal testing machine, 300 kN capacity

Consists of an HM-D rack with 300 kN capacity and the following test tools:

Set of lever operated tensile grips, including:

Set of wedges for round specimens of between 8 and 20 mm.

Set of wedges for flat specimens of between 0 and 15 mm.

Set of compression plates of $\text{Ø}140$ mm.

PC control and measurement (computer, monitor, keyboard, mouse and printer)

Software running under Windows with metal-testing program and interface card

ENAC official calibration certificate

Instruction manual

Electro-mechanical universal testing machines

HM-V rack

The HM-V racks are basically designed to test low-resistance, high-stretch materials, such as low-capacity springs, fabrics, rubber, etc. These machines are well known for their small size and high performance.

They consist of a base plate, a robust steel column with a precision guide on two skids that keeps the mobile support horizontal. On the overhanging support is the load cell used for load measurement.

There is a top fixed plate on the upper area that also overhangs and is equally ready to bear tensile or compression forces. The mobile support moves when the drive spindle turns, moving the nut. The entire unit (spindle-guide-column) is protected by a steel housing with accordion-type bellows.

Powered by an electro-mechanical direct current servo-motor and two recirculating ball screw spindles, to ensure smooth operation and constant speed during tests.

Base support box that includes the spindle motor, gearbox and transmission, as well as the servo-motor control electronics. Two test areas (upper and lower), ready for the application of tensile loads in the upper area and compression loads in the lower area. Universal load cell (tensile/compression) mounted on the mobile cross-bar for measuring loads in both test areas.

Easy assembly of all test tools (tensile, compression, bending...) The base plate is commonly used for mounting of the supporting components for folding, lower compression plate and so on. The tensile grips are usually installed in the upper area. There is no need for movement of intermediate crossbars because it is already motorised throughout its travel.

The spindle is protected electrically by a system of adjustable limiters with end-stops to limit travel to the pre-set maximum. This system with end-of-run end stops operates by stopping the electric motor. These racks have a CV-PC control panel that allows the user to control servo-motor speed manually, maintain constant test speeds, view digital readings and control end-of-run pushbuttons and sensors, over-scaling and so on.

Control by PC can also be provided (this would require the appropriate electronics and ETIWIN program) via RS-232C serial cable. These are manufactured in two versions - motorised and manual with two wheels, one for approach (high speed) and another for tests (slow speed).



HM-V rack

SPECIFICATIONS (kN)	2	2	5
TYPE	Manual	Motorised	
Model	E0056	E0057	E0058
Machine type	Manual	electro-mechanical	
Spindle travel (mm)	up to 500	up to 1000	
Test speed (mm/min)	Manual	0 - 1000	
Drive	Manual	motor-driven	
Height (mm)	1300	1800	
Width (mm)	350	500	
Depth (mm)	525	525	
Power supply	200 V. single ph. 50/Hz. 2500 W		
Calibration Certificate	ENAC		

Installed in the rack itself, it includes:

Front panel with CV-PC illuminated control buttons
 Digital speed display (199.9/19.99 mm/min) Potentiometers for speed adjustment (manual control)
 PIC controller for digital input/output, relays, etc.

E0056 Electro-mechanical manually operated machine, 2 kN capacity x 500 mm

HM-V rack, 2 kN capacity.
 Digital display of load (F) and displacement (L)
 ENAC official calibration certificate
 Instruction manual

The test tools must be ordered separately

E0057 Electro-mechanical motor-driven machine, 2 kN capacity x 1000 mm

HM-V rack, 2 kN capacity.
 - Digital display of load (F), displacement (L) and test speed (CV)
 - ENAC official calibration certificate
 - Instruction manual

*The test tools must be ordered separately

E0058 Electro-mechanical motor-driven machine 5 kN capacity x 1000 mm

HM-V rack, 5 kN capacity.
 Digital display of load (F), displacement (L) and test speed (CV)
 ENAC official calibration certificate
 Instruction manual

*The test tools must be ordered separately

Optional accessories and spare parts for Universal Machines
Tensile grips with lever:

- E0017** Set of tensile grips, 30 mm wide x 1-2 kN, includes set of flat or round wedges (at option).
- E0018** Set of tensile grips, 30 mm wide x 5-10 kN, includes set of flat or round wedges (at option).
- E0018/1** Set of tensile grips, 30 mm wide x 20 kN, includes set of flat or round wedges (at option).
- E0018/2** Set of tensile grips, 50 mm wide x 50 kN, includes set of flat or round wedges (at option).
- E0018/3** Set of tensile grips, 50 mm wide x 100 kN, includes set of flat or round wedges (at option).
- E0018/4** Set of tensile grips, 70 mm wide x 200 kN, includes set of flat or round wedges (at option).
- E0018/5** Set of tensile grips, 70 mm wide x 300 kN, includes set of flat or round wedges (at option).

Wedges for tensile grips:

- E0019** Set of 0-6 mm flat wedges for 1-2 kN tensile grips.
- E0019/1** Set of 0-8 mm flat wedges for 5-10 kN tensile grips.
- E0019/2** Set of 0-8 mm flat wedges for 20kN tensile grips.
- E0019/3** Set of 0-12 mm flat wedges for 50kN tensile grips.
- E0019/4** Set of 0-12 mm flat wedges for 100kN tensile grips.
- E0019/5** Set of 0-15 mm flat wedges for 200kN tensile grips.

Optional accessories and spare parts for Universal Machines

- E0019/6** Set of 0-15 mm flat wedges for 300 kN tensile grips.
- E0020** Set of 3-8 mm round wedges for 1-2 kN tensile grips.
- E0020/1** Set of 4-10 mm round wedges for 5-10 kN tensile grips.
- E0020/2** Set of 4-10 mm round wedges for 20 kN tensile grips.
- E0020/3** Set of 6-16 mm round wedges for 50 kN tensile grips.
- E0020/4** Set of 6-16 mm round wedges for 100 kN tensile grips.
- E0020/5** Set of 8-20 mm round wedges for 200 kN tensile grips.
- E0020/6** Set of 8-20 mm round wedges for 300 kN tensile grips.

Compression plates:

- E0025** Compression plate Ø 100 mm 1-2 kN.
- E0025/1** Compression plate Ø 100 mm 5-10 kN.
- E0025/2** Compression plate Ø 100 mm up to 50 kN.
- E0025/3** Compression plate Ø 140 mm up to 300 kN.

Bending test crossheads rollers and punch:

- E0033** Adjustable bending test crosshead 1000 mm (20 kN) for HM-D racks
- E0034** Adjustable bending test crosshead 1000 mm (100 kN) for HM-D racks
- E0035** Adjustable bending test crosshead 1000 mm (300 kN) for HM-D racks
- E0024** Adjustable bending test crosshead 0 -200 mm (1-2 kN) for HM-V racks
- E0024/1** Adjustable bending test crosshead 0 -200 mm (5-10 kN) for HM-V racks

Spring tools:

- E0032** Plates with parallelism control 1-2 kN.
- E0032/1** Plates with parallelism control 5-10 kN.
- E0032/2** Hooks for spring tensile test 1-2 kN.
- E0032/3** Hooks for spring tensile test 5-10 kN.

Terminal and cable tools:

- E0029** Pincer grips for flat terminals
- E0030** Wire grips Ø 2 mm, capacity (5-10 kN)
- E0031** Cable grips Ø 1-12 mm, capacity (1-2 kN)
- E0031/1** Cable grips Ø 1-12 mm, (5-10 kN)
- E0031/2** Cable grips Ø 1-12 mm, (50-100 kN)

Extensometers:

- E0022** EXT-502/35 extensometer for diameters up to 35 mm.
 - E0022/1** EXT-502/100 extensometer for diameters up to 100 mm.
 - E0026** Device for testing removal of electrowelded wire mesh.
- Other types of grips can be manufactured on request in accordance with customer specifications*

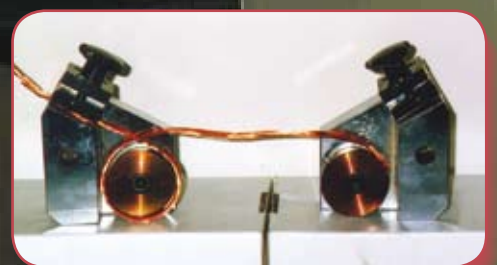

E0051 ETIWIN control software

Running under WINDOWS, this software captures the data generated during the tests and also controls the press, with the following features:

Closed loop servo-control of load, displacement, deformation or time (ramps or functions).

Direct control of the servo-motor (constant speed).

Automatic selection and change of working scales.

Automatic stop after specimen rupture detection.

Programming of control files with up to 10 steps, allowing preselection of up to 10 speed changes or control modes during a test. The "Management -> Control Files" menu allows the creation of as many files as needed.

PARAMETER	CONTROL	UNITS
F	LOAD	N/s. (Mpa/s.)
R	RESISTANCE	N/mm ² /s.
D	DISPLACEMENT	mm/s.

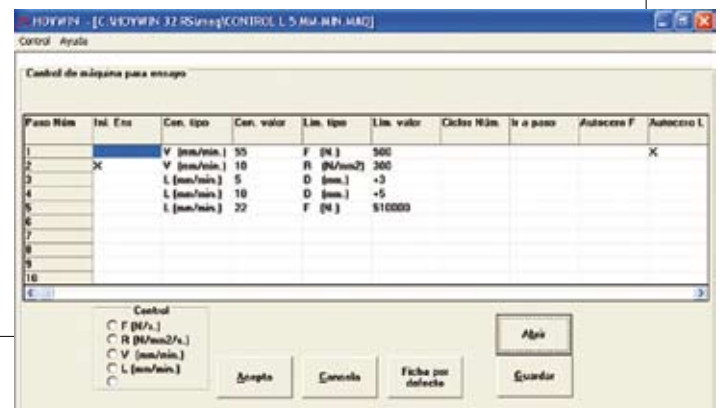
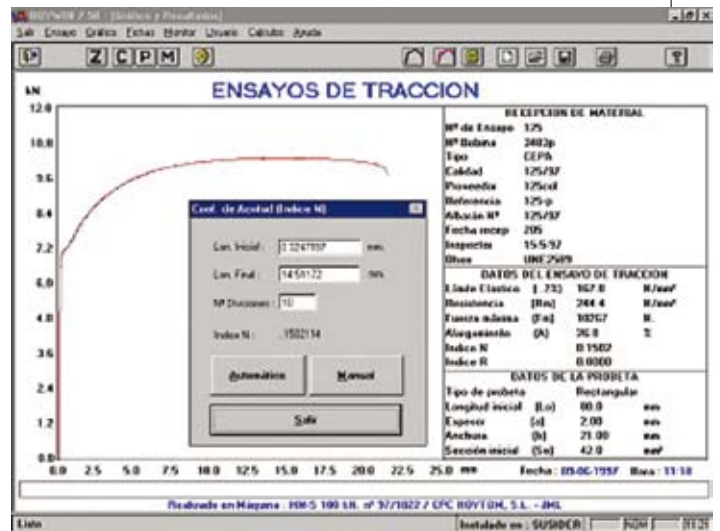
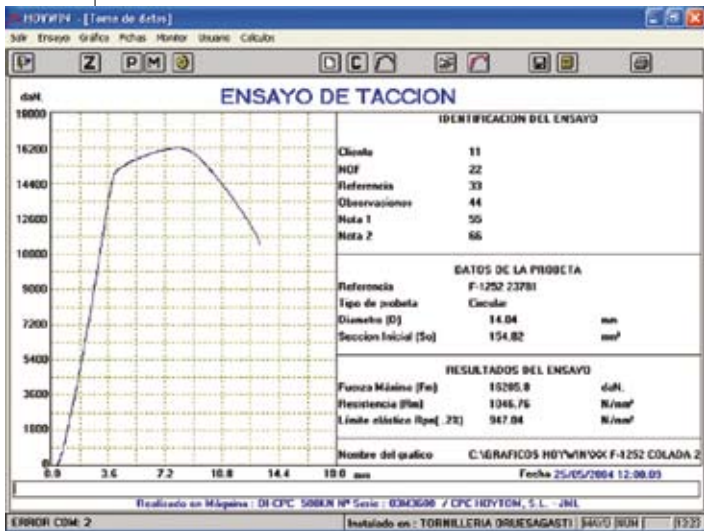

Measurement software

Data processing software for static metal tests, with the following features:

Selection of control files (speeds, etc)

Specimen sheet selection with:

- Specimen reference or name
- Type: Rectangular/Circular/Tubular/Sample
- Initial specimen length
- A, B/D/So section dimensions
- N % for any value (0.01%-0.2 %-1%) to calculate the Rpn

Test file selection (Test no., material, date,... and another 10 user-defined fields)

Automatic or manual test graph scales

Real time display in "load-deformation" units (kN-mm)

Digital display simultaneous with graph

Automatic filing of X-Y values of the graph in a backup file so they can be recovered.

Comparison of up to 10 graphs on the screen.

Facility for calculation and display of limits

- ReH, ReL (apparent in mild steels)
- Rpn (n = 0.2 % or any other value entered)
- E elastic modulus of the material
- Rm maximum resistance.
- A elongation and other test parameters (Ag, E, N, R, ...)

Data export (results sheets) in ASCII, EXCEL files for analysis by other databases.

Zooming option with the mouse anywhere on the screen.

Optional manual selection of scales and units.

Compensation for cell deformation.

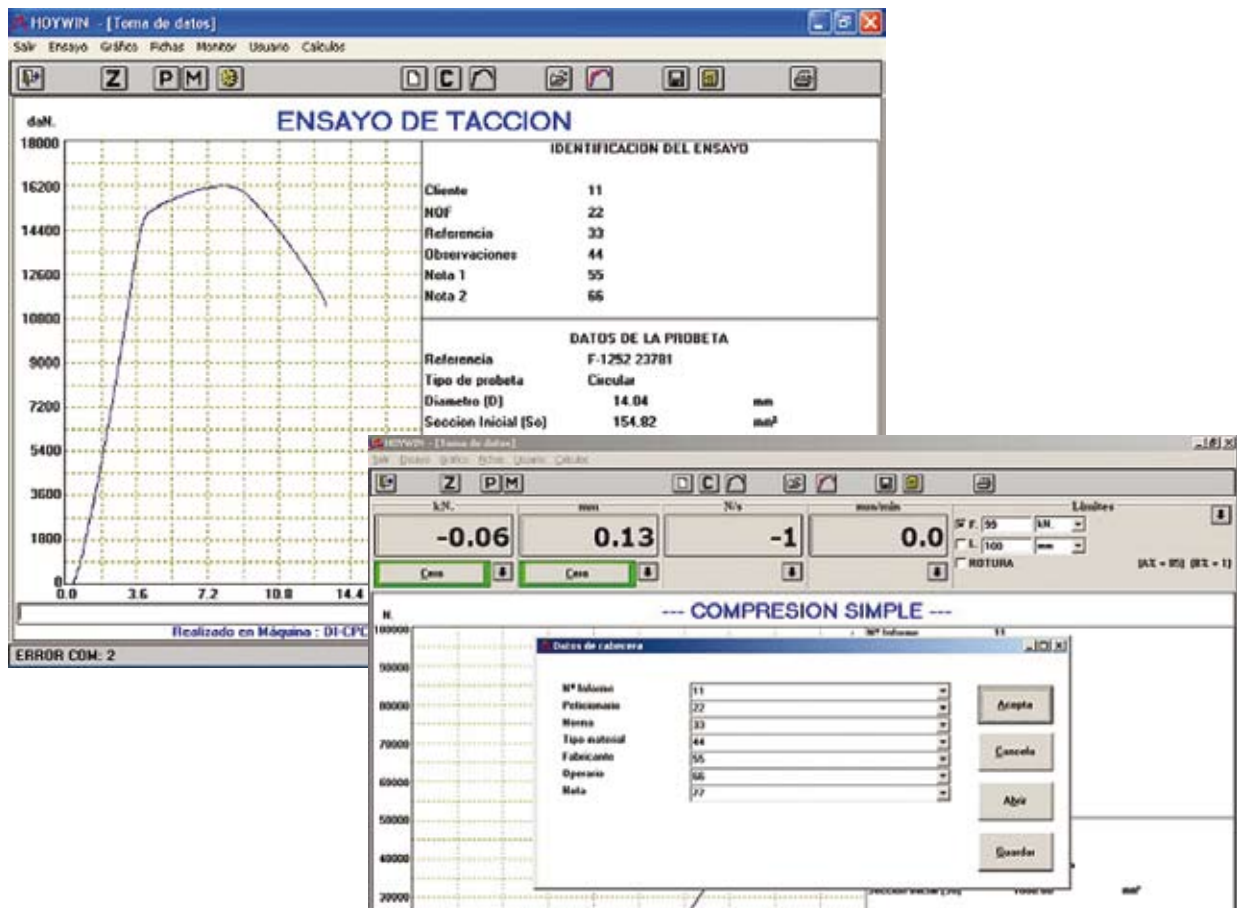

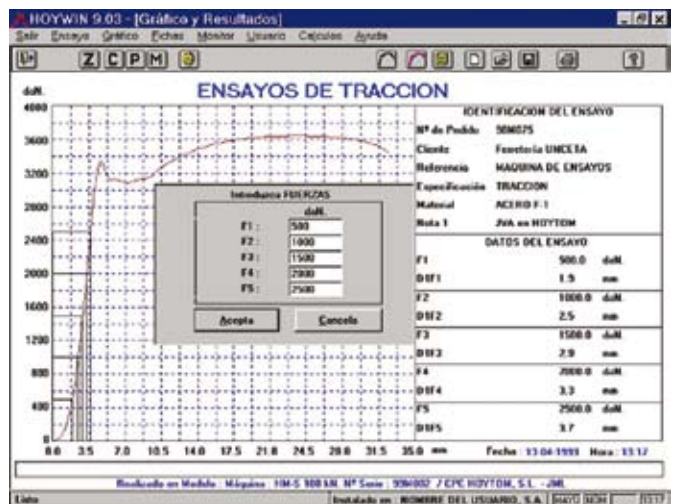
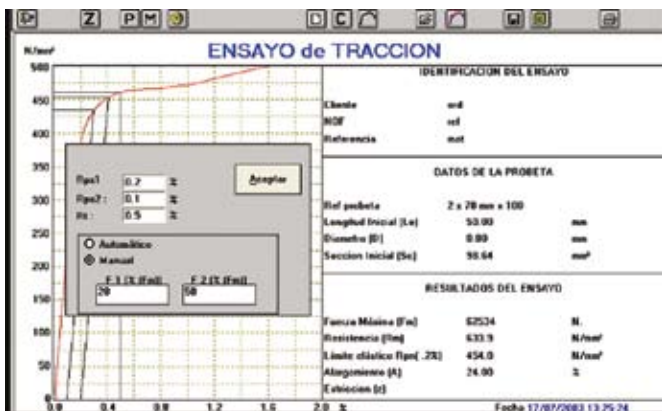
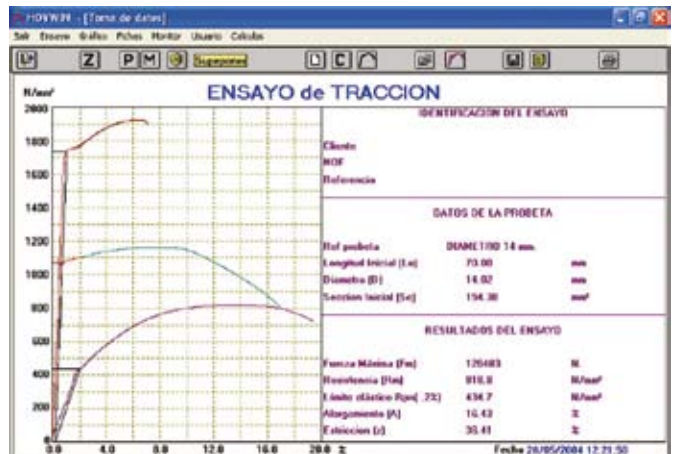
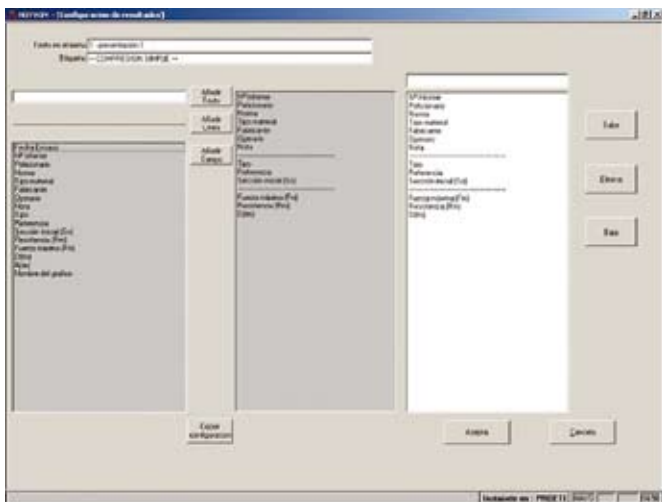
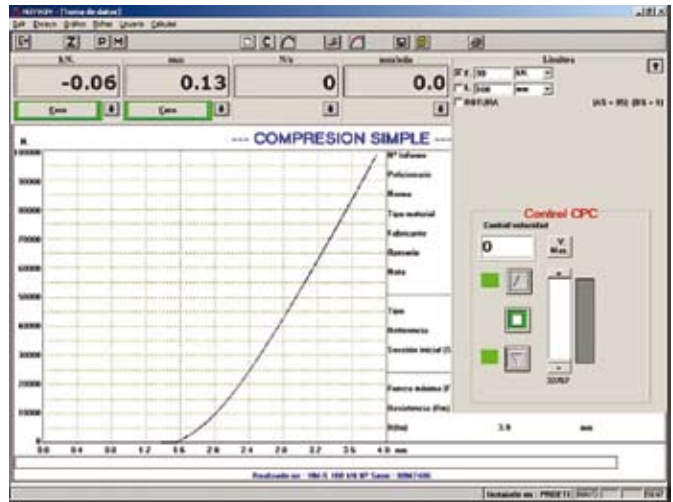
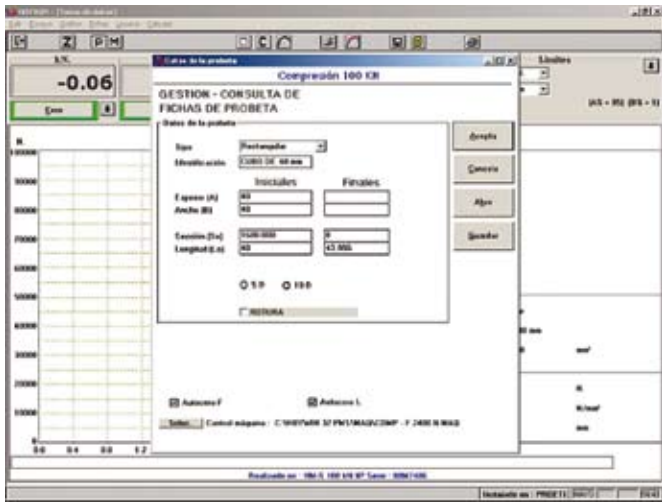

Marking and folding

E0060 Motorised bar marker

Designed to mark tensile test specimens. The space between signs on the sample is marked at pre-established intervals, dividing it into equal parts so that the elastic deformation of the specimen can be calculated after the test. The machine has an end-stop which allows marks for intervals of 5-10-15 and 20 mm.

Test specimen dimensions:

Round: Ø 40 x 400 mm

Square: 65 x 400 mm

Power supply: 220 V. 50 Hz.

Dimensions: 510 x 380 x 400 mm

Weight: 62 kg.



E0064 Bar cutter

Takes cutting discs of up to Ø 350 mm

Cutting capacity: 120 mm

Rotation speed: 3900 rpm

Power supply: 220-240 V 1PH 50 Hz 2000W

Dimensions: 560x460x390

Weight: 20 kg

Supplied complete with Ø 350 mm cutting disc.



Spares:

E0064/1 Cutting disc Ø 350 mm

Standards UNE EN ISO 7438, UNE 36068;ASTM A615

E0065 Bar bending machine with auto-programmable automaton

Steel bar bending machine with a 32-part set (14 machine bolts and 18 bushings) for bending and unbending tests of bars measuring between Ø 32mm in flat steel and 25mm in corrugated steel. Programmable automaton to select the angles for ten consecutive bending operations.

Includes portable remote pedal and bending angle adjustment by inserting kingpins in the holes of the bending plate that butt against the end-stop. Safety button for emergency stops in the event of incorrect operation. Several rods can be bent simultaneously.

Supplied with the equipment necessary to perform steel bar tests according to EHE and complies with the following standards:

Weldable corrugated steel bars, as per UNE 36065/2000

Weldable corrugated steel bars for reinforced concrete framework, as per UNE 36068/1994

Weldable corrugated steel wire for reinforced concrete framework, as per UNE 36099/1990

Technical characteristics

Maximum bending diameter: 32 mm.

Bending plate speed: 12 rpm

Braking motor power: 4 Hp.

Power supply: 220/380V 50/60 Hz (others on request)

Dimensions: 900 x 760 x 1020 mm

Weight: 535 kg

Accessories

E0065/1 Stirrup bending tool.

E0065/2 Double bending tool.

E0065/3 Round stirrup bending tool.



Ultrasound

Standard UNE EN 1714

E0068 Ultrasound fracture and defect detector. RP 3000

Very easy to use equipment, appropriate for use in locations where light weight, robustness and ease of handling are normal working requirements. Specifically designed for work in dockyards, construction, railways, etc.

Technical characteristics

Frequency range: long bandwidth 0.5 - 15 MHz (-3dB).

Amplification: 130 dB adjustable by 2 (0-40) and 20 dB (0-20-40-60).

Type of display: linear echo range.

Rejection: double, linear or normal, internal selection of 0-80% of the range.

Minimum measurement range: 0 - 5 mm Fe.

Maximum measurement range: 0 - 10 m Fe.

Delay: 0 - 600 mm.

Frequency of repetition: automatic for different fields.

Monitor: channel with optional output, visual and sound alarms.

Vertical linearity: 1dB drift, 0.05 dB/°C heat drift.

Horizontal linearity: 1% maximum drift of measurement field

Power supply: 220/110 V - 50/60 Hz.

Battery life: 8 hours.

Operating temperature: -10 to 50°C.

Screen dimensions: 70 x 55 mm

Dimensions: 220 x 104 x 302 mm

Weight: 5 Kg (batteries included).

The standard kit includes

RP 3000 unit.

Monitor module.

Two connection cables for probes.

Screwdriver set.

Can of coupling fluid.

Spare fuse.

Certificate of approval (RINA).

Instruction manual.

Optional recommended accessories

E0068/1 Carrying bag, opaque to sunlight

E0068/2 Battery charger and connection cables

E0068/3 Set of rechargeable batteries

E0068/4 MODELO V1 calibration unit

E0068/5 Twin crystal probe, SD 10-4 10 mm 4 MHz.

E0068/6 Simple cylindrical/flat crystal probe SN 10-4 10 mm 4MHz

E0068/7 Miniature probe, simple trapezoidal crystal, SMA 70-4, 8x9 mm 4 MHz. 70°

E0068/8 Miniature probe, simple trapezoidal crystal, SMA 45-4, 8x9 mm 4 MHz. 45°



E0068D EPOCH ultrasound fracture and defect detector.

The new EPOCH LT is the thinnest, lightest fault detector ever made, only 38 mm thick and weighing 1 kg. The EPOCH LT offers high frequency screen updating (minimum of 60 Hz), automatic feeler calibration, numerical data recording and various measurement functions. The EPOCH LT is the ideal solution for easy, fast defect detection under difficult conditions or in demanding production environments.

Technical characteristics:

Lightweight (1.1 kg) and ergonomic design;
 High screen updating frequency (minimum 60 Hz);
 High power NiMH battery;
 Large liquid crystal screen with bright colours and high resolution, full screen or split screen;
 Automatic feeler calibration;
 Display mode that freezes and retains wave form and acoustic path data;
 Acoustic path data displayed in millimetres, inches or microseconds;
 Memorisation of peaks feature;
 Non-rectified wave display (radiofrequency);
 Alarms: Positive/Negative tolerance threshold or minimum depth;
 Numerical data recording;
 Compatible with EMAT (E110-SB) feelers;
 Standard DAC/TVG functions.

Software options:

Various software options specifically adapted to particular applications make the EPOCH LT extremely versatile. These functions can be activated remotely -after purchasing the unit- saving the inconvenience of sending it back to the plant.
 DAC and TVG advanced functions;
 Standard API 5UE;
 Square wave emission;
 Standards AWS D.1 and D.5;
 Incorporated DGS/AVG functions;
 Expanded memory;
 Low pulse repetition frequency (PRF);
 Measurement of echo-to-echo thickness;
 Expanded range;



Weld control

Standards EN 1290, EN 12.062-02
Non-destructive welded joint test.
Magnetic particle weld testing.
E0088 Magnetic particle test equipment
Technical characteristics:

Power supply: 220 V
 Frequency: 50 Hz.
 Weight: 3.2 kg
 Lifting strength: 17
 Outward terminal field current: 70A/cm (iron bar measuring 50 x 20 mm length 400 mm)
 Inward terminal field current: 42A/cm (in plate measuring 500 x 500 x 10 mm)
 Flow rate > 2T (In plate measuring 500 x 500 x 10 mm)
 Outward terminal anvil measurements: 285 mm.
 Inward terminal anvil measurements: 105 mm.

UV lamp

Current: 200 W (Measured at 200 mm)
 Power: 100 W.
 Height: 225 mm.
 Weight: 1.2 kg
 Cable length: 3.75 m.

Equipment supplied with:

TWM 220N Yoke
 UV focused beam lamp
 UV lamp transformer
 Spare light bulb
 Spare UV filter
 2 flexible terminals
 Carrying bag

Accessories

E0088/1 Fluoflux concentrate 3.0 um 1/50 1 litre.



Standards UNE EN 1289/1M:2002

Non-destructive welded joint test. Penetrating liquid welding test. Detects cracks by introduction of penetrating liquids

Penetrating liquid inspection is a universal method used to detect and view open defects in the surface of non-porous materials.

The basic principle of the method is very simple. First, clean all grease and dirt from the surface to be inspected. Afterwards, apply a coloured product known as a penetrant. If there are any cracks or defects, the penetrant will enter them due to capillarity, regardless of the size of the crack.

Remove excess penetrating liquid from the part so the surface is completely clean except for the penetrating liquid in the cracks. Then apply a coat of highly absorbent product, known as a developer, that acts like desiccant paper forcing the penetrant to come out of the crack, so its location and approximate dimensions are visible.

The main advantages of using penetrating liquids for inspection over other crack detection methods are:

It can be used on both ferrous and non-ferrous materials.

The size and shape of the specimen to be inspected are not important.

Very good cost/efficacy ratio.

The procedure is simple and application is not difficult.



E0230 Red Penetrating Aerosol 996P

E0231 Aerosol Remover 9PR5

E0232 Aerosol Developer 9D1B

Resilience test

EN 10045/1 – UNE 7475 – ASTM E23 – DIN 50115

The resilience test is used to determine the energy absorbed in the rupture of a notched specimen by a single stroke from the pendulum hammer. This resistance is known as resilience and expressed in joules. A falling pendulum is used to perform this test, which measures the residual energy after rupture, or in other words, the difference between the total energy generated by the machine and the energy absorbed by the material. Machine capacities can be 150, 300, 450 or 750 Joules. The scale is divided into joules and degrees.

The pendulum consists of a die cast base and two columns that hold the CHARPY specimen support system, the pendulum hammer and arm, the hammer lifting system and triggering mechanism, the measuring scale for direct reading of the energy absorbed by the test specimen and a belt friction brake that acts on the hammer to quickly absorb the oscillations. Each pendulum is checked in the factory and all verifications required by standards are carried out.

There are three factory versions: - analogue with manual hammer lift.

Digital with manual hammer lift.

Automatic with digital display and motorised hammer lift.

Charpy pendulums

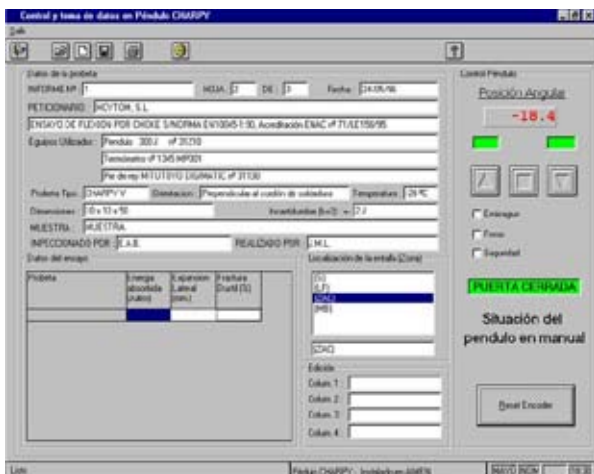

The equipment consists of the following components:

- Cast iron base with the chosen measurement system
- Impact blade (DIN or ASTM)
- Support centring element
- Charpy pliers
- Checklist
- Anchor and foundation drawing
- Instruction manual

Optional items:

- Steel protection screen along the entire travel path.
- PC reading systems using an UP/DOWN counter card to insert in the PC and file and statistics data processing software.
- Electrical powering and braking system with servo-motor reducer worm gear and electrical braking controlled from a manoeuvring and protection panel attached to the pendulum, with pushbuttons.

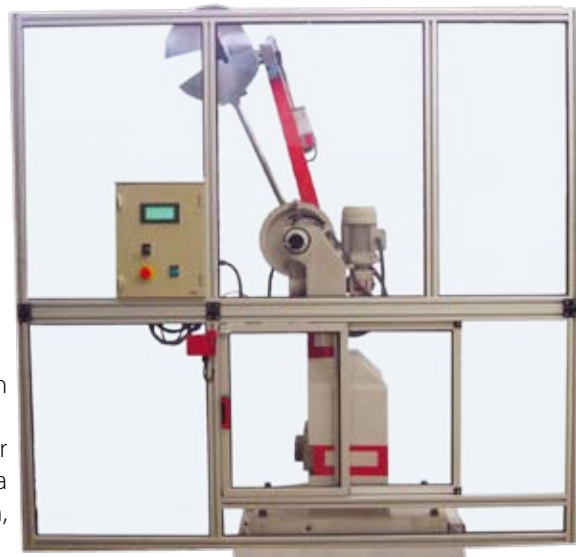

Charpy pendulums

PC control system, control software, input/output cards, connection cards and relays to operate the electrical drive system from the PC.

Available Models:

E0070 Charpy pendulum with 150 J capacity, complete with impact blade, support centring element, Charpy pliers, checklist, anchoring drawing and Instruction manual.

Display: analogue

Hammer lift: worm gear wheel

Brake: brake pedal and drum

Impact speed: 5.43 m/s

Resolution: 1 J / 1°

Hammer weight: 10 kg

Pendulum length: 800 mm

Pendulum dimensions: 750 x 500 x 1250 mm

Protection dimensions: 800 x 800 x 2150 mm

Pendulum weight: 520 kg

E0071 Charpy pendulum with 300 J capacity, complete with impact blade, support centring element, Charpy pliers, checklist, anchoring drawing and Instruction manual.

Display: analogue

Hammer lift: worm gear wheel

Brake: brake pedal and drum

Impact speed: 5.43 m/s

Resolution: 2 J / 1°

Hammer weight: 20 kg

Pendulum length: 800 mm

Pendulum dimensions: 750 x 500 x 1250 mm

Protection dimensions: 800 x 800 x 2150 mm

Pendulum weight: 560 kg

E0071/1 Charpy pendulum with 300 J capacity, complete with impact blade, support centring element, Charpy pliers, checklist, anchoring drawing and Instruction manual.

Display: digital

Hammer lift: worm gear wheel

Brake: brake pedal and drum

Impact speed: 5.43 m/s

Resolution: 2 J / 1°

Hammer weight: 20 kg

Pendulum dimensions: 750 x 500 x 1250 mm

Protection dimensions: 800 x 800 x 2150 mm

Pendulum weight: 560 kg

E0071/2 Automatic Charpy pendulum with 300 J capacity, complete with protection cabinet furnished with electrical safety system, impact blade, support centring element, Charpy pliers, checklist, anchoring drawing and instruction manual.

Display: digital

Hammer lift: motor-driven

Brake: automatic

Impact speed: 5.43 m/s

Resolution: 2 J / 1°

Hammer weight: 20 kg

Pendulum dimensions: 750 x 500 x 1250 mm

Protection dimensions: 800 x 800 x 2150 mm

Pendulum weight: 560 kg

Accessories:

- E0075** Additional impact blade (DIN or ASTM)
- E0076** Support centring element
- E0077** PC reading program for digital pendulums (PC not included)
- E0078** Motor-driven lifting system for 300 J pendulums.
- E0081** CHARPY V-2 notch brush.
- E0082** CHARPY U-2 notch brush.
- E0082/1** CHARPY U-3 notch brush.
- E0082/2** CHARPY U-5 notch brush.
- E0083** Protection cabinet with electrical safety system
- E0084** ASTM lateral expansion verifier
- E0084/1** Perpendicular verifier

Broaching machines:

Designed to make correct "U" or "V" notches in the various Charpy specimens.



E0079 Manual broaching machine, easy to use and maintain, makes "V" or "U" notches correctly and very quickly using a multiple tooth broach, as specified in EN and ASTM standards. The machine can be mounted on a bench.



E0080 Motor-driven broaching machine, built for endurance, independent and provided with a three phase motor. The broaching tool is fastened to a carriage, which is driven by a lead screw over the whole length. The notches are made in square material measuring 10 mm as per Standards EN 10045-1 and ASTM E23.

Measurements: 381 x 381 x 1120 mm

Hardness test

In the Rockwell test, hardness is determined by comparison, by measuring the depth of two carefully controlled indentations, one superimposed on the other.

First, a small load is applied (the weaker load) with a steel ball or a round-conical diamond indenter. Then, while the smaller load continued to be applied, a larger load is applied (the stronger load) with controlled precision. The larger load is removed, revealing the specific hardness. The hardness evaluation is obtained from

the additional depth marked on the sample by the larger load, over and above the initial indentation made by the smaller load. In the normal Rockwell scale (R), the smaller load is 10 kgf and the larger load can be 60, 100 or 150 kgf. In the superficial scale (S), the smaller load is 3 kgf and the larger load can be 15, 30 or 45 kgf.

Standard UNE EN ISO 6508

Rockwell and Super-Rockwell hardness testing machines

These machines are designed to perform normal Rockwell tests (with loads of 60, 100 and 150 kp), and Rockwell Superficial tests (with loads of 15, 30 and 45 kp), although they can also be used with additional loads to perform Brinell and Vickers tests. The analogue models (E0092) display the hardness readings on a special gauge with Rockwell scales and 1 HR unit resolution, whereas the digital models (E0093) use a DIGIDUR processor with an electronic feeler with a resolution of 0.1 HR units.

E0092 Rockwell universal hardness testing machine, especially designed to perform normal Rockwell tests (with loads of 60, 100 and 150kp) Rockwell Superficial (with loads of 15, 30 and 45kp), but also provided with other additional loads for Brinell or Vickers tests. The machine consists of a robust C rack that includes application systems for test loads and indentation depth measurement. The Rockwell system is used to verify parts made of metal, plastic, rubber, etc.

Characteristics:

Pre-loads: 3 and 10 kgf.
 Rockwell superficial loads: 15, 30 and 45 kgf.
 Rockwell loads: 60, 100 and 150 kgf.
 Other loads (Brinell): 31.25, 62.5, and 187.5 kgf.
 Load selection: external rotating selector.
 Application speed: adjustable by external control.
 Vertical capacity: 300 mm.
 Gooseneck (horizontal): 175 mm.
 Lighting: 15 W / 110 V lamp.
 Dimensions: 530 x 250 x 800 mm
 Measuring system: analogue dial gauge.
 Steel placement: manual.

Accessories included:

1 Rockwell 120° diamond cone indenter
 2 Rockwell 1/16" and 1/8" steel ball indenters
 2 Brinell Ø 2.5 and 5mm steel ball indenters.
 6 spare balls for each diameter.
 4 test blocks for Rockwell HRC HRB, HR30N, HR30T
 1 pre-block hold down plate.
 2 flat-based part-holding trays (Ø 50 and 10mm)
 2 V-based part-holding trays for cylinders between 3 and 10mm Ø and one for cylinders between 10 and 70mm Ø.
 1 wooden case for accessories (screw driver, connection cable, dust cover).
 1 Instruction manual with conversion tables.



Standard UNE EN ISO 6508
Rockwell and Super-Rockwell hardness testing machines

E0093/SDR Rockwell universal duplex digital hardness testing machine (capacity up to 2500 N), especially designed to perform Rockwell Normal or Superficial tests and ready to perform Brinell and Vickers tests. Test loads: 11 loads.

Rockwell Normal: 10 - 60 - 100 and 150 kp.

Rockwell Superficial: 3 - 15 - 30 and 45 kp.

Brinell: - 31.25 - 62.5 and 187.5 kp.

Vickers: 3 - 10 - 30 - 60 and 100 kp.

Load selection: rotating selector control.

Application speed: adjustable by external control.

Lighting: incorporated.

Clear reading digital display.

Performs mathematical mean calculations.

RS 232-C output for communication to a computer or printer.

Automatic zero reset.

Indication of faulty handling during test.

Digital display of Rockwell Normal and Superficial scales with scale selection and display deletion push buttons.

Transformer-power supply.

Data output cable.

Installation of a plate with the dial gauge switch, push button for mathematical mean calculation and data output connector.

Capacity: 0-300 mm / 170 mm.

Accessories included:

5 Rockwell indenters (3) (diamond cone, 1/16 and

1/8) balls (2) Brinell (2.5 and 5 mm balls).

4 bags with 6 spare balls for each diameter.

2 Rockwell C and B hardness test blocks, respectively.

2 Rockwell HR-30-N and HR-30-T hardness test blocks.

4 part-holding trays (flat smooth \varnothing 50 mm) flat with ledge

measuring 10 mm \varnothing , V-shaped for cylinders measuring between 3 and

10 mm \varnothing , V-shaped for cylinders measuring between 10 and 70 mm \varnothing .

1 Pre-block pedal.

1 Connection cable.

1 Screwdriver.

1 Wooden case.

1 Plastic dust cover.

1 Conversion table.

1 Equivalence table.

Optional accessories:

E0094 Magnifying glass 20X

E0099 Magnifying glass 40X

E0097 Magnifying glass 100X

E0096 Vickers diamond

E0098 Additional Brinell HB 2.5/187.5 table

E0095 Additional Vickers HV100 plates.

E0100 Additional HRC plates

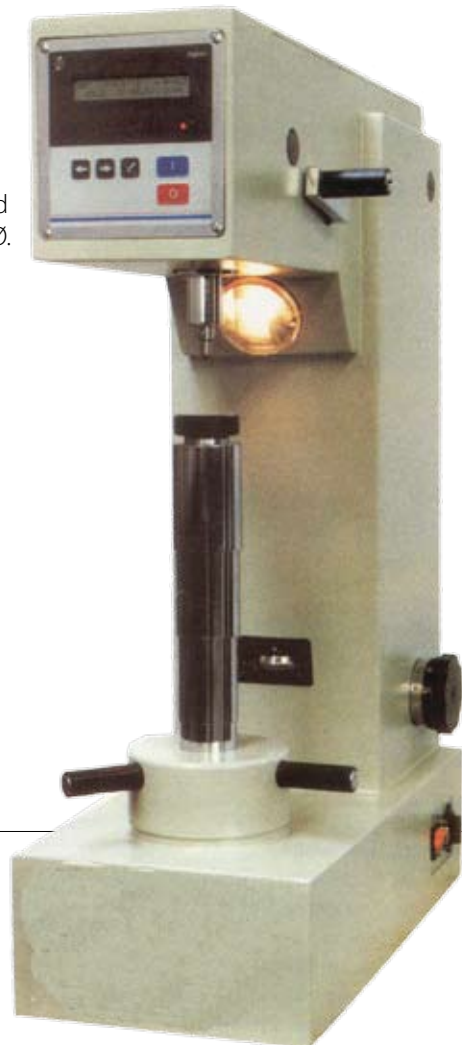

Rockwell, Brinell, Vickers universal hardness testing machine

E0105 Rockwell minor-69 hardness testing machine, designed for simple but complete hardness testing of relatively small specimens. Supported hardness test methods: Rockwell, Brinell and Vickers

Test loads:

- For Rockwell HR 10 ; 60; 100; 150 kg
- For Brinell HB 31.25 ; 62.5; 125; 187.5 kg
- For Vickers HV 10 ; 20; 60; 100 kg

Test load selection by piled weights, labelled with their load.
 Manual crank-operated application of test loads.
 Load speed adjustment with adjustable hydraulic shock absorber.
 Test capacity: 170 x 150 mm.
 Measuring system: special analogue dial gauge with Rockwell scales.
 Automatic zero reset when preload reaches 10 kg.

Accessories included:

- 1 - Rockwell 120° diamond cone indenter
 - 1 - Rockwell 1/16" steel ball indenter
 - 1 - Rockwell 1/8" steel ball indenter
 - 1 - Brinell 2.5 mm steel ball indenter
 - 1 - Brinell 5 mm steel ball indenter
 - 4 - bags with 6 spare balls for each diameter.
 - 1 - HRC test block (150 kp 120° cone)
 - 1 - HRB test block (100 kp and 1/16" ball)
 - 1 - flat smooth part-holding tray measuring Ø 50 mm
 - 1 - flat part-holding tray with flat ledge measuring Ø 10 mm
 - 1 - V-shaped part-holding tray for cylinders between 3 and 10 mm
 - 1 - V-shaped part-holding tray for cylinders between 10 and 70 mm
- Screwdriver, wooden case, plastic dust cover, conversion tables and instruction manual



Rockwell, Brinell, Vickers universal hardness testing machine

E0106 Rockwell minor-69-D3 hardness testing machine, this is the basic model in the Proetisa range of hardness testing machines, very useful for those requiring a simple, comprehensive hardness testing machine for relatively small specimens.

Supports Rockwell hardness methods.

Test load selection by piled weights, labelled with their load.
 Manual crank-operated application of test loads.
 Load speed adjustment with adjustable hydraulic shock.
 Screw capacity (vertical) 170 mm.
 Gooseneck capacity (horizontal) 150 mm.
 DIGITAL measuring system. Touch screen.
 Automatic zero reset, on reaching preload of 10 kg.

Characteristics:

- Test loads:** Rockwell HR 10 - 60 - 100 - 150 kg
- Vertical capacity:** 170 mm
- Gooseneck:** 150 mm
- Dimensions:** 430x210x600 mm
- Net weight:** 70 kg
- Gross weight:** 90 kg

Accessories included:

- 1 - Rockwell 120° diamond cone indenter
 - 1 - Rockwell 1/16" steel ball indenter
 - 2 - bags with 6 spare balls for each diameter.
 - 1 - HRC test block (150 kp 120° cone)
 - 1 - HRB test block (100 kp and 1/16" ball)
 - 1 - flat smooth part-holding tray measuring Ø 50 mm.
 - 1 - flat part-holding tray with flat ledge measuring Ø 10 mm
 - 1 - V-shaped part-holding tray for cylinders between 3 and 10 mm.
 - 1 - V-shaped part-holding tray for cylinders between 10 and 70 mm.
- Screwdriver, wooden case, plastic dust cover, conversion tables and instruction manual



Standards UNE EN ISO 6506-1; ASTM E10-66; AFNOR NF-A03; ISO R156

Brinell hardness testing machines

The Brinell steel test determines the resistance to penetration by a hardened steel ball measuring \varnothing 10 mm, under a load of 3000 kg (500 kg for light metals). The Brinell hardness scale is based on the ratio between kilogram load and surface area of the indentation in square centimetres.

E0110 Brinell hardness testing machine, especially designed for tests on porous metals and alloys. The equipment is easy to use and extremely accurate.

Technical characteristics:

- Ball diameter:** from 5 to 10 mm
- Pressure limits:** 500, 750, 1000 and 3000 kg
- Accuracy:** $\pm 1\%$
- Maximum height of the test sample:** 250 mm
- Horizontal spacing:** 150 mm
- Dimensions:** 500 x 240 x 800 mm
- Weight:** 128 kg



Supplied complete with wooden case and includes as standard accessories 6 hardened steel balls measuring \varnothing 10 mm, a set of weights (5 parts) to stabilise the pressure, 1 test block, 1 V-shaped support for round specimens, 1 microscope for measuring indentation diameters, with a precision of 0.1 mm, 1 plastic dust cover and an instruction manual.

E0111 Brinell hardness testing machine, automatic cycle measurer for chain testing, equipped with hydraulic and electronic components and digital display.

Technical characteristics:

- Pressure limits:** 250, 500, 750, 1000 and 3000 kg
- Maximum height of the test sample:** 340 mm
- Horizontal spacing:** 150 mm
- Measurements:** 1020 x 900 x 450 mm
- Weight:** 254 kg

Supplied complete with standard accessories:

- 1 flat part holding table.
- 1 V-shaped part holding table.
- 1 ball indenter of 10 mm
- 6 Brinell spare balls of \varnothing 10 mm.
- 1 Brinell HB test specimen, 1 set of conversion tables. 1 push pedal,
- 12 litre oil can (Hydraulic 225).
- 1 plastic dust cover and instruction manual.

E0112 Brinell hardness testing machine, automatic cycle measurer for chain tests, similar to the E0111 model but with a "Digidur" processor.

Digital hardness testing machines

E0115 MH-180 portable hardness testing machine

General characteristics:

Maximum measurement range: Based on the Leeb hardness test theory. Leeb hardness can be measured in all metallic materials. Large LCD screen that displays all the functions and parameters with backlight.

Six different devices for special applications are available. Automatic identification of the type of impact device.

Tests at any angle, even from below.

Direct HRB, HRC, HV, HB, HS, HL hardness scale reading

Its large memory can store up to 100 groups (from 32 to 1 impact) including mean value, direction of impact, time of impact, material, hardness scale, etc.

Remaining battery charge information.

User calibration function.

Software to connect to a PC through the RS-232 port.

Compact plastic briefcase, for the toughest working conditions.

Automatic energy saving shutdown.



Technical characteristics:

Measurement range: HLD (179~960)

Measurement angle: 0~360°

Hardness scale: HL, HB, HRB, HRA, HV, HS

Large screen LCD

Working voltage: 3V (2 AA alkaline batteries)

Approximately 100 hours continuous operation (backlight off)

Communication interface: RS-232



E0116 KH-100 portable hardness testing machine

The KH-100 portable hardness testing machine is one of the most versatile and accurate on the market.

The KH-100 model is small, light and easy to transport.

User-friendly, robust and very versatile.

RS-232 port connection directly to a PC.

Appropriate for testing large specimens and heavy components.

Ideal for manufacturing process quality controls.

Suitable for the identification of stored material.

Automatic conversion to Brinell, Rockwell, Vickers, Shore hardnesses ...

Tests on steel, tooling steel, stainless steel, grey cast iron, bronze, copper, aluminium ...

Technical characteristics:

Large LCD screen with back light.

Resolution: $\pm 0.5\%$ (HLD= 800)

Data storage: 1250 groups.

Measurement range: HLD (200~960)

Measurement angle: 0~360°

Hardness scale: HL, HB, HRB, HRC, HV, HS

Working voltage: 3V (2 AAA alkaline batteries)

Communication interface: RS-232

Automatic mean value.

Dimensions: 108 x 61 x 25 mm

Weight: 108 g



E0145 Metal cutting machine

Extra-firm bench that includes a pump and a 30 litre tank for coolant.
 Precision grip, downward tightening, opening 100 x 70 mm (ratchet).
 3 HP motor, tropicalised and located in an airtight cabin.
 Aluminium disc protection case with coolant intake.
 Totally airtight cutting cabin.
 Springs for easy opening and positioning of the cabin hood.
 Action lever (lifting the part) with lateral displacement of 25 mm and a 0.1 mm reading on the vernier scale.
 Closed door safety microswitch that stops the machine if the door opens.
 Splatter proof side window for cutting extra long parts.
 Uses 250 or 300 mm diameter cutting discs.
 Power connection: three phase 380 V

Spare parts:

- E0150** Cabin hood
- E0151** Universal 100 mm grip.
- E0152** Universal 75 mm grip.
- E0153** Universal 50 mm grip.
- E0154** Complete cooling unit

Accessories:

- E0155** Corundum discs 300 x 2 x 22 mm for steels >45 HRC.
- E0156** Corundum discs 300 x 2 x 22 mm for steels <45 HRC.
- E0157** Corundum discs 250 x 1.5 x 22 mm for steels >45 HRC.
- E0158** Corundum discs 250 x 1.5 x 22 mm for steels <45 HRC.

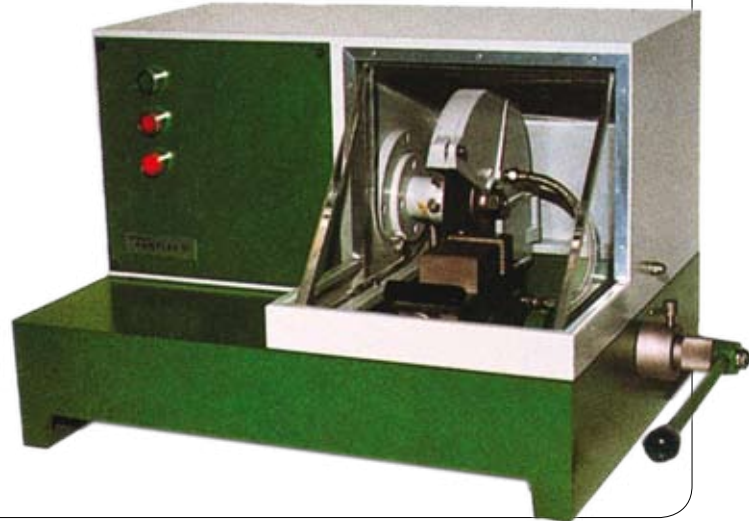
Metal presses

E0180 Metal press, a metal press for mounting resin samples. Powered by a manual hydraulic pump with a twin safety valve, connection cable and a 0-300 kg/cm manual pressure gauge². Superfast heating equipment with interchangeable 400 W resistor at 220 V for very short heating times. Electronic thermocouple-activated temperature control from 0 to 200°C. Complete moulding equipment to make undeformable Ø 30 mm steel tablets. The cooling unit consists of two light alloy cooling media, with fins and large heatsink surfaces.

Dimensions: 450 x 700 x 330 mm

Weight: 70 kg

Spare parts:

- E0180/1** Complete moulding unit Ø 30 mm.
- E0180/2** Complete moulding unit Ø 25 mm.
- E0180/3** Complete heating unit
- E0180/4** Complete cooling unit
- E0180/5** Monobloc resistance 400 W.

Accessories:

- E0180/6** Epoxigraf moulding resin 1000 cc.
- E0180/7** Lumigraf amber moulding resin 1800 cc.
- E0180/8** Lumigraf red moulding resin 1800 cc.
- E0180/9** Lumigraf green moulding resin 1800 cc.
- E0180/10** Lumigraf blue moulding resin 1800 cc.



8

GENERAL MATERIAL

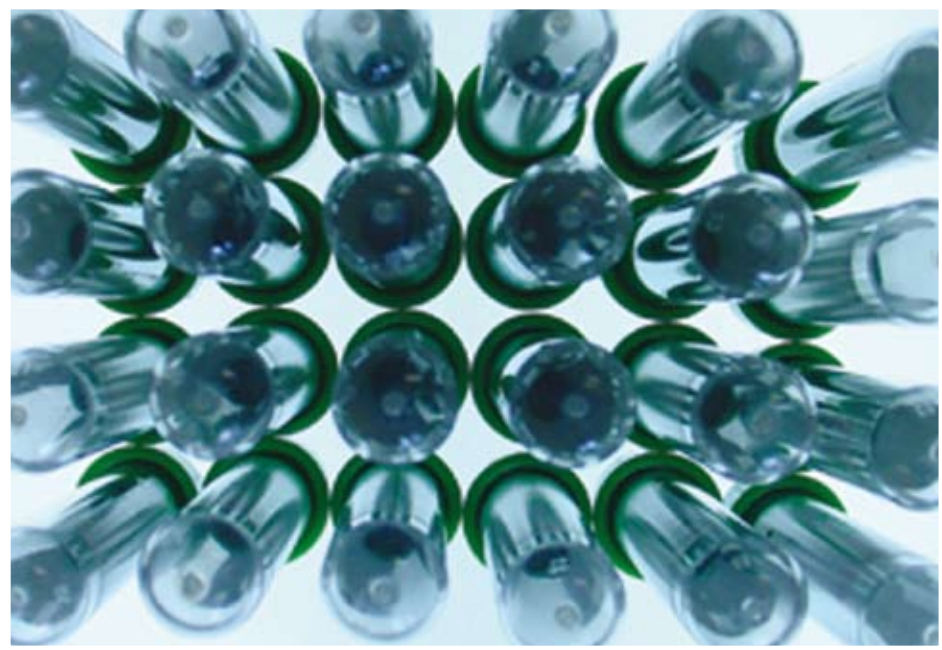

Dynamometric rings

Dynamometric rings

PROETI dynamometric rings are made from specially treated chrome steel and are compression calibrated. They can be used both as instruments to verify the calibration of testing machinery and to measure strength. They are supplied complete with centesimal indicator with a 10 mm run and an ENAC calibration certificate, all in a convenient carrying case. On request, can be equipped with a millesimal indicator.



REFERENCE	Capacity in kN	Accuracy (mm)	Weight (kg)
V0001	0.50	0.001	1.2
V0002	1	0.01	1.3
V0003	2	0.01	1.8
V0004	5	0.01	1.9
V0005	10	0.01	2.1
V0006	30	0.01	3.6
V0007	50	0.01	4.5
V0008	100	0.01	6.4
V0009	200	0.01	11.8
V0010	2	0.001	1.4
V0011	1	0.001	1.3

Dial indicators

Dial indicators

Dial indicators used for a wide range of applications normally required by laboratories.

V0024 Digital dial indicator, with 12.7 mm capacity and 0.001 mm resolution.

Accessories:

V0025 Indicator lock to retain the maximum reading.

V0030 Adjustable magnetic base for attachment of indicators.



	Capacity (mm)	Accuracy (mm)
	0.50	0.001
V0014	5	0.001
V0016	10	0.01
V0017	30	0.01
V0018	50	0.01
V0019	100	0.01

Immersion thermostats

Immersion thermostats to measure the temperature of the water in a bath.

Technical characteristics:

An electronic temperature control system with digital programming and display. Accuracy $\pm 1\%$.

Stirring pump with external circulation adjustable from 1 to 5 L/min.

External cooling coil to work at room temperature or lower.

Visual alarm in case of over-temperature. Fastening system for various types of buckets.

REFERENCE	CAPACITY	MEASUREMENTS (mm)		
		Height	Width	Bottom
V0105	9 litres	15	29	22
V0106	12 litres	15	31	29
V0107	20 litres	15	48	29
V0108	27 litres	20	48	29



Thermostatic baths

Thermostatic baths

Double body construction made of metal, anti-oxidant treatment on the outside, painted with epoxy and stainless steel 18/10 interior.

Heated electrically by resistors shielded with stainless steel.

Electronic temperature control with digital programmer and display.

Equipped with an alarm in case of over-temperature.

REFERENCE	CAPACITY (l)	MEASUREMENTS (mm)			TEMPERATURE °C
		Height	Width	Bottom	
V0115	5	22	29	22	100
V0116	5	22	31	29	200
V0117	12	31	48	29	100
V0118	12	31	48	29	200
V0119	20	48	48	29	100
V0120	20	48	48	29	200

Accessories:

V0115/1 Perforated lid and 80, 60 and 40 cm reducer discs, two pax. For 5 L baths.

V0117/1 Perforated lid and 80, 60 and 40 cm reducer discs, four pax. For 12 L baths.

V0120/1 Perforated lid and 80, 60 and 40 cm reducer discs, six pax. For 20 L baths.

V0115/2 Sloping lid, for 5 L baths.

V0117/2 Sloping lid, for 12 L baths.

V0120/2 Sloping lid, for 20 L baths.

V0115/3 Heating element cover tray, for 5 L baths.

V0117/3 Heating element cover tray, for 12 L baths.

V0120/3 Heating element cover tray, for 20 L baths.

V0123 Drain tap.



Heating plates

Rectangular heating plates

Made of non-warping steel, electronic settings, digital programming and display. Accuracy: 1%

REFERENCE	MEASUREMENTS (cm)	RANGE (°C)
V0125	20 x 40	40 - 400
V0126	25 x 50	40 - 400
V0127	20 x 40	30 - 200
V0128	25 x 50	30 - 200



Circular heating plates

V0130 Circular heating plate measuring \varnothing 150 mm, made from non-warping steel. Temperature range up to 400°C. Includes a safety device that disconnects the current in the event of over-temperature. Electronic control with the option of attaching a contact thermometer or digital programmer.

Accessories:

V0130/1 Support rod \varnothing 12 x 450 mm.

V0130/2 Rear socket for contact thermometer.



Magnetic stirring rods

Magnetic stirring rods

Cabinet made of injected aluminium, painted in epoxy.

Circular stainless steel plate measuring \varnothing 150 mm.

Illuminated switches and settings controls for heating and stirring, located on the front panel.

Stirring capacity: 10 l.

Speed: adjustable between 30 - 1800 rpm.

V0135 Magnetic stirrer with heating, complete with device for connecting a contact thermometer.

Heating power: 500 W

Plate temperature: adjustable up to 350°C.

V0136 Magnetic stirrer without heating.

Accessories:

V0130/1 Support rod \varnothing 12 x 450 mm.

V0136/1 Cylindrical stirring rod \varnothing 3 x 6 mm

V0136/2 Cylindrical stirring rod \varnothing 5 x 12 mm

V0136/3 Cylindrical stirring rod \varnothing 6 x 20 mm

V0136/4 Cylindrical stirring rod \varnothing 8 x 40 mm



Temperature

Fast action digital thermometers

V0149 Maximum/Minimum temperature thermometer

V0150 Digital thermometer display -50 +150°C, complete with stainless steel probe, ON/OFF switch, LCD screen and battery.
Resolution: 0.1°C.



B0211 Double range digital thermometer display -50 +250°C, complete with stainless steel probe, ON/OFF switch, LCD screen and battery. **Resolution:** 0.1°C/150°C and 1°C/250°C.



V0152 Digital thermometer with piercing probe, -50 +400°C.

Compact with many advantages, large display, "Hold" key and high precision. The measuring probe attached to the device is designed for a wide range of applications that require fast temperature measurement. It is supplied complete with piercing probe, battery, protective cover and instruction manual.

Accuracy: $\pm 1^\circ\text{C}$.

Resolution: 0.1°C.

Measurements: 190 x 57 x 42 mm

Weight: 300 g

V0153 Digital thermometer with interchangeable probe, -50 +1000°C. Ideal for tough routine industrial temperature applications. The measurement probes (chosen with the order) are interchangeable. Supplied complete with battery, calibration report and instruction manual.

Accuracy: $\pm 1^\circ\text{C}$.

Resolution: 0.1°C.

Measurements: 190 x 57 x 42 mm

Weight: 300 g

Accessories:

V0153/1 Immersion/Piercing probe

V0153/2 Surface measurement probe

V0153/3 Protective cover



V0155 Humidity/Temperature measuring instrument and Dew Point calculator.

Complete with separate humidity/temperature probe, 1 m connecting cable, instruction manual and battery.

Range of humidity: 5 to 95%RH

Temperature range: 0 + 50°C.

Accuracy: ± 3 %RH / ± 0.4 °C.

Resolution: 0.1°RH/ 0.1°C

Display: 2 LCD lines.

Measurements: 190 x 57 x 42 mm

Weight: 300 g

Accessories:

V0155/1 Non-warping protective case.

V0155/2 Adapter for surface humidity measurements.

V0155/3 Battery charger.

V0155/4 Flask for control and settings.

V0155/5 Calibration certificate.

V0156 Compact electronic hygrothermograph.

A "data logger" with integrated probe and memory storage capacity for up to 20,000 measurements. Built in a strong anodised aluminium box. Windows Software. Supplied complete with integrated humidity/temperature probe, battery, magnet, instruction manual and calibration report.

Range of humidity: 5 to 100%RH

Temperature range: -10 + 50°C.

Accuracy: ± 3 %RH / ± 0.6 °C.

Resolution: 0.1°RH/ 0.1°C

Measurements: 131 x 68 x 72 mm

Weight: 320 g

Accessories:

V0156/1 Confort software with interface.

V0156/2 Carrying case.

V0157 Compact electronic hygrothermograph,

similar to model V0156, but highly accurate, simultaneous measurement of dew point and memory storage capacity for up to 55,000 measurements. Supplied complete with integrated humidity/temperature probe, battery, magnet, instruction manual and calibration report.

Range of humidity: 0 to 100%RH

Temperature range: -20 + 70°C.

Accessories:

V0157/1 Control and adjustment set.

V0157/2 Convenient professional software.

V0157/3 Stainless steel head Sintered.

V0157/4 Calibration certificate.



Rectangular base with supporting legs and stainless steel rod.

REF.	ROD (mm)	BASE (mm)
V0190	8 x 500	200 x 125
V0191	10 x 600	250 x 160
V0192	12 x 700	315 x 200
V0193	12 x 800	315 x 200



Galvanised steel closed retort ring.

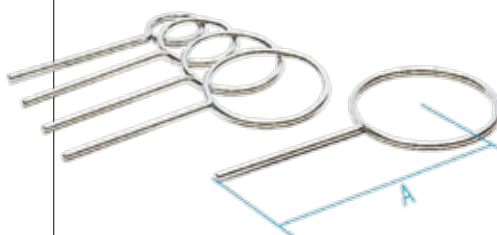

REF.	COLLAR (mm)	MEASUREMENTS (mm)
V0195	60	180
V0196	80	195
V0197	100	200
V0198	120	215
V0199	140	225

Metal fabrics with ceramic fibres

REF.	MEASUREMENTS (mm)
V0205	100
V0206	120
V0207	140
V0208	160
V0209	180
V0210	200



Tripod supporting legs and stainless steel rod.

REF.	MEASUREMENTS (mm)
V0215	100
V0216	120
V0217	140



Tripod supporting legs and stainless steel rod.

REF.	MEASUREMENTS (mm)
V0230	80 x 210
V0231	100 x 210 mm
V0232	120 x 210 mm



Galvanised steel closed retort ring with bosshead.

REF.	COLLAR (mm)	MEASUREMENTS
V0220	100	100
V0221	120	130
V0222	140	160
V0223	160	170
V0224	180	180



Double-ended flat microspatula

REF.	ROD (mm)
V0235	80 x 4
V0236	120 x 4
V0237	150 x 4
V0238	210 x 4

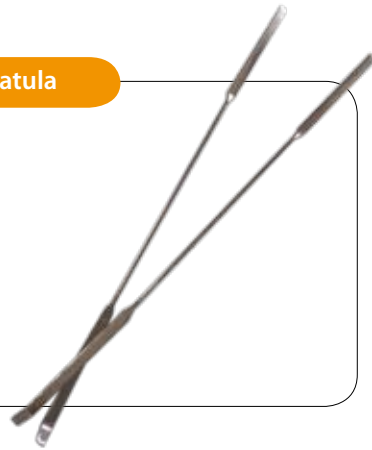
Laboratory test tube racks

REF.	ROD (mm)	MEASUREMENTS (mm)
V0260	160 x 125	160 x 125 x 80 x 65
V0261	235 x 180	235 x 180 x 110 x 95
V0262	160 x 125	160 x 125 x 80 x 65
V0263	235 x 180	235 x 180 x 110 x 95

Curved double-ended spatulas

REF.	ROD (mm)
V0240	120 x 15
V0241	150 x 25
V0242	180 x 25
V0243	210 x 25

Wooden-handled spatulas

REF.	ROD (mm)	REF.	BLADE MEASUREMENTS (mm)
V0246	80 x 14	V0250	160 x 24
V0247	100 x 16	V0251	200 x 29
V0248	120 x 18	V0252	240 x 34
V0249	140 x 22	V0253	280 x 34

Other

V0255 Flat spoon spatula, in stainless steel

Total length: 210 mm.

VIBRATING SPATULAS, with manual vibration device, in stainless steel

Measurements: 176 x 12 mm

V0257 Curved tip

V0258 Grooved tip



Bunsen burner with air and gas control knob

- V0285 Butane gas burner, measurements Ø 11 x 140 mm.
- V0286 Natural gas burner, measurements Ø 11 x 140 mm.
- V0287 Butane gas burner, measurements Ø 13 x 170 mm.
- V0288 Natural gas burner, measurements Ø 13 x 170 mm.

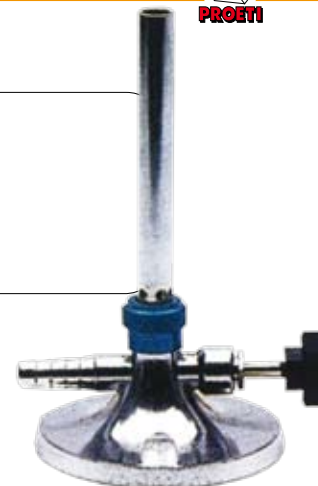

Teflon magnets, with rotating pivot

- V0310 Magnet-collecting rod, flexible, teflon-coated.
Length: 280 mm

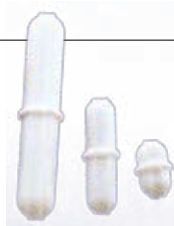

Hanging drying racks, made from PVC wire

- V0315 Drying rack, with 32 hangers.
- V0316 Drying rack, with 48 hangers.
- V0317 Drying rack, with 88 hangers.
- V0320 Pipette rack, with room for 40 pipettes of different sizes.

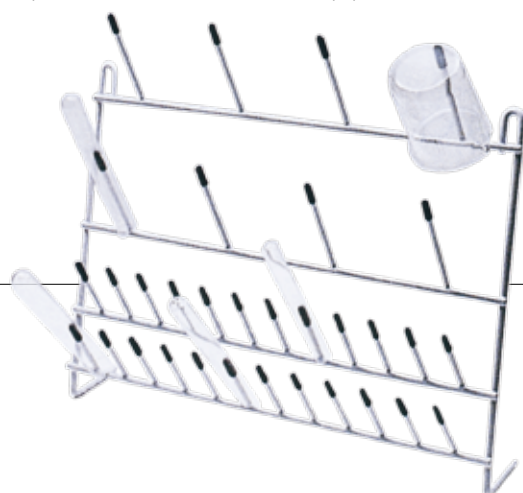

Iron mortar with grey steel pestle

- V0340 Iron mortar with grey steel pestle
Measurements: Ø 130 x 65 mm
- V0341 Iron mortar with grey steel pestle.
Measurements: Ø 150 x 75 mm



Pipette pump filler

- V0350 Pipette pump filler, 0 - 2 mL, blue.
- V0351 Pipette pump filler, 0 - 10 mL, green.
- V0352 Pipette pump filler, 0 - 25 mL, red.

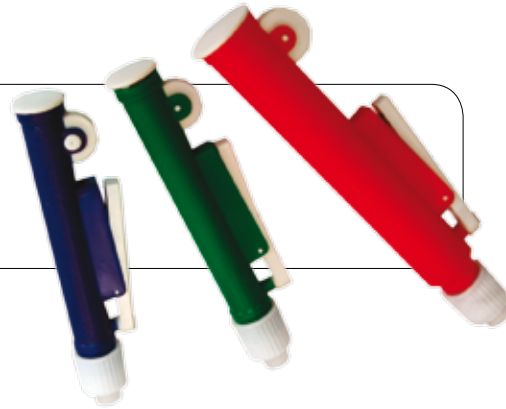

Brush for cleaning laboratory material



- V0355 Beaker brush.
- V0356 Probe cylinder brush.
- V0357 Flask brush.
- V0358 Burette brush.
- V0359 Test tube brush.

Benchttop muffle furnaces

Muffle furnaces capable of 1200 °C



AP (Automatic Pyrometer) feature, equipped with automatic temperature control.
 Excellent temperature uniformity.
 Quick heating and cooling.
 Analogue or digital temperature display.

Technical characteristics:

DIGITAL		V0370	V0372
ANALOGUE		V0371	V0373
Temperature resistant chamber temperature control		Low density refractory KANTHAL 1200°C automatic	
Chamber	Height	80 mm	160 mm
	Width	130 mm	200 mm
	Bottom	150 mm	230 mm
Dimensions	Height	430 mm	490 mm
	Width	300 mm	430 mm
	Bottom	330 mm	450 mm
Power		1.700 W	3.800 W
Weight		20 kg	41 kg

High temperatures muffle furnaces

Built with state-of-the-art technology, the most advanced insulating fibres and thermal insulation elements. Automatic digital control equipment. For use in high temperature tests, cement, metallurgy.

Model	Temp.	Chamber (mm)	MEASUREMENTS(mm)	Power	Weight
V0385	1800°C	140 x 135 x 150	680 x 600 x 650	5000 W	90 kg
V0386	1650°C	100 x 130 x 250	550 x 870 x 670	5700 W	110 kg
V0387	1525°C	100 x 130 x 250	550 x 870 x 670	4600 W	100 kg
V0388	1450°C	120 x 172 x 250	560 x 750 x 720	4600 W	100 kg
V0389	1450°C	140 x 170 x 300	680 x 600 x 640	7200 W	70 kg
V0390	1375°C	140 x 170 x 300	680 x 600 x 640	6500 W	65 kg
V0391	1350°C	100 x 140 x 154	620 x 500 x 600	3500 W	58 kg



Muffle ovens capable of 1000 and 1200 °C

Model	Temperature	Chamber (mm)	MEASUREMENTS (mm)	Power	Weight
V0375	1000°C	100 x 150 x 200	505 x 460 x 560	2200 W	90 kg
V0376		150 x 200 x 300	650 x 480 x 650	3300 W	98 kg
V0377		200 x 280 x 390	700 x 620 x 760	5500 W	185 kg
V0378	1200°C	100 x 150 x 200	505 x 460 x 560	3300 W	90 kg
V0379		150 x 200 x 300	650 x 480 x 650	5300 W	98 kg
V0380		200 x 280 x 390	700 x 620 x 760	8000 W	185 kg

A reinforced design, insulated with top quality fibres. Automatic digital control equipment.
 Excellent temperature uniformity.
 Quick heating and cooling.
 Digital control and display

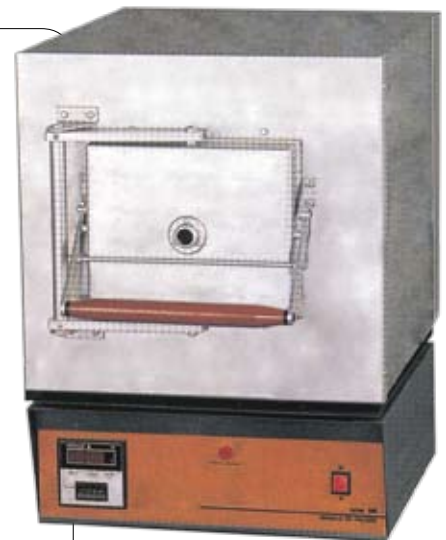

Pumps

V0410 Vacuum pump

- Rated flow:** 4m³/h (65 L/m)
- Vacuum limit:** 3
- Oil capacity:** 0.2
- Weight (kg):** 9.5
- Rotating speed (rpm):** 1450
- Motor power (kW):** 0.150
- Power supply (1 ph):** 220 V/50 Hz
- Noise level (dBA):** 57
- Measurements (mm):** 184 x 150 x 322



V0411 Verifying pump

- For fast, accurate checks of pressure or airtightness in plumbing and heating installations.
- Supplied complete with certified pressure gauge
- Approx. pressure:** 50 bar.

Chemical products

All types of chemical products are delivered on request







Thermometers

REF	ASTM	RANGE	IMMER (mm)	REF	ASTM	RANGE	IMMER (mm)
V1001	01C	-20 + 150 1°C	76	V1057	57C	-20 + 50 0.5°C	57
V1002	02C	-5 + 300 1°C	76	V1058	58C	-34 + 49 0.5°C	TOTAL
V1003	03C	-5 + 400 1°C	76	V1059	59C	-18 + 82 0.5°C	TOTAL
V1005	05C	-38 + 50 1°C	108	V1060	60C	+77 + 260 1°C	TOTAL
V1006	06C	-80 + 20 1°C	76	V1061	67C	+32 + 127 0.2°C	79
V1007	07C	-2 + 300 1°C	TOTAL	V1062	62C	-38 + 2 0.1°C	TOTAL
V1008	08C	2 + 400 1°C	TOTAL	V1063	63C	-8 + 32 0.1°C	TOTAL
V1009	09C	-7 + 110 0.05°C	57	V1064	64C	+25 + 55 0.1°C	TOTAL
V1010	10C	+ 90 + 370 2°C	57	V1065	65C	+50 + 80 0.1°C	TOTAL
V1011	11C	-6 + 400°C 2°C	25	V1066	66C	+75 + 105 0.1°C	TOTAL
V1012	12C	-20 + 102 0.2°C	TOTAL	V1067	67C	+ 95 + 155 0.2°C	TOTAL
V1013	13C	+155 + 170 0.5°C	TOTAL	V1068	68C	+145 + 205 0.2°C	TOTAL
V1014	14C	+38 + 82 0.10C	79	V1069	69C	+195 + 305 0.5°C	TOTAL
V1015	15C	-2 + 80 0.2°C	TOTAL	V1070	70C	+295 + 405 0.5°C	TOTAL
V1016	16C	-30 + 200 0.5°C	TOTAL	V1071	71C	-37 + 21 2°C	76
V1017	17C	+19 + 27 0.1°C	TOTAL	V1073	73C	-41.4 - 38.6 0.05°C	TOTAL
V1018	78C	+34 + 42 0.1°C	TOTAL	V1082	82C	-15 + 105 1°C	30
V1019	19C	+49 + 57 0.1°C	TOTAL	V1083	83C	+15 + 70 1°C	40
V1020	20C	57 + 65 0.1°C	TOTAL	V1084	84C	+25 + 80 1°C	249
V1021	21C	+79 + 87 0.1°C	TOTAL	V1085	85C	+40 + 150 1°C	181
V1022	22C	+95 + 103 0.1°C	TOTAL	V1086	86C	+95 + 175 1°C	35
V1023	23C	+ 18 + 28 0.2°C	90	V1087	87C	+150 + 205 1°C	40
V1024	24C	+ 39 + 54 0.2°C	90	V1088	88C	+10 + 200 1°C	57
V1025	25C	+95 + 105 0.2°C	90	V1089	89C	-20 + 10 0.1°C	76
V1026	26C	+130 + 140 0.1°C	TOTAL	V1090	90C	0 + 30 0.1°C	76
V1027	27C	+ 1 47 + 1 82 0.2°C	76	V1091	91C	+20 + 50 0.1°C	76
V1033	33C	-38 + 42 0.2°C	50	V1092	92C	+40 + 70 0.1°C	76
V1034	34C	+25 + 105 0.2°C	50	V1093	93C	+60 + 90 0.1°C	76
V1035	35C	+90 + 170 0.2°C	51	V1094	94C	+80 + 110 0.1°C	76
V1036	36C	-2 + 68 0.2°C	45	V1095	95C	+100 + 130 0.1°C	76
V1037	37C	-2 + 52 0.2°C	100	V1096	96C	+120 + 150 0.1°C	76
V1038	38C	+24 + 78 0.2°C	100	V1097	97C	-18 + 49 0.5°C	TOTAL
V1039	39C	+ 48 + 1 02 0.2°C	100	V1098	98C	+16 + 82 0.5°C	TOTAL
V1040	40C	+ 72 + 1 26 0.2°C	100	V1100	100C	+145 + 205 0.2°C	76
V1041	41C	+98 + 152 0.2°C	100	V1101	101C	+195 + 305 0.5°C	76
V1042	42C	+95 + 255 0.2°C	100	V1102	102C	+123 + 177 0.2°C	100
V1044	44C	+18.5 + 21.5 0.05°C	TOTAL	V1103	103C	+148 + 202 0.2°C	100
V1045	45C	+ 23.6 + 26.4 0.05°C	TOTAL	V1104	104C	+173 + 227 0.2°C	100
V1046	46C	+48.6 + 51.4 0.05°C	TOTAL	V1105	105C	+198 + 252 0.2°C	100
V1047	47C	+58.6 + 61.4 0.05°C	TOTAL	V1106	106C	+223 + 277 0.2°C	100
V1049	49C	+20 + 70 0.2°C	65	V1107	107C	+248 + 302 0.2°C	100
V1052	52C	-10 + 5 0.1°C	TOTAL	V1110	110C	+133.6 + 136.4 0.05°C	TOTAL
V1054	54C	+20 + 100.6 0.2°C	TOTAL	V1111	111C	+170 + 250 0.2°C	100
V1056	56C	+ 19 + 35 0.02°C	TOTAL	V1112	112C	+4 + 6 0.02°C	TOTAL

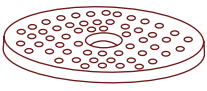

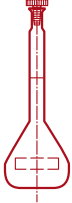

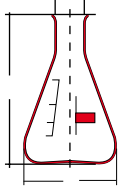
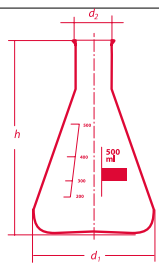

REF	ASTM	RANGE	IMMER (mm)
V1113	113C	-1 + 175 0.5°C	TOTAL
V1114	114C	-80 + 20 0.5°C	TOTAL
V1116	116C	+18.9 + 25.1 0.5°C	TOTAL
V1117	117C	+23.9 + 30.1 0.01°C	TOTAL
V1118	118C	+28.6 + 31.4 0.05°C	TOTAL
V1119	119C	+ -38 - 30 0.1°C	100
V1120	120C	+38.5 + 41.5 0.05°C	TOTAL
V1121	121C	+98.6 + 101.4 0.05°C	TOTAL
V1122	122C	-45 - 35 0.1°C	TOTAL
V1123	123C	-35 - 25 0.1°C	TOTAL
V1124	124C	-25 - 15 0.1°C	TOTAL
V1125	125C	-15 - 5 0.05°C	TOTAL
V1126	126C	-27.4 - 24.6 0.05°C	TOTAL
V1127	127C	-21.45 - 18.6 0.05°C	TOTAL
V1128	128C	-1.4 + 1.4 0.05	TOTAL
V1129	129C	+91.6 + 94.4 0.05°C	TOTAL



	Reference	Diameter	Drying	
PORCELAIN DISCS	V6200	90	100	
	V6201	140	150	
	V6202	190	200	
	V6203	240	250	
	V6204	290	300	



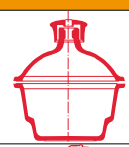
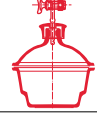
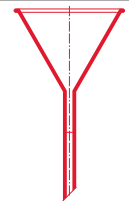

	Reference	Capacity mL	
VOLUMETRIC FLASKS, WITH POLYETHYLENE STOPPERS - ISO 1042, DIN 12.664	V6358	10	
	V6359	25	
	V6360	50	
	V6361	100	
	V6362	250	
	V6363	500	
	V6364	1000	
	V6365	2000	
VOLUMETRIC FLASKS WITHOUT STOPPERS ISO 1042, DIN 12.664	V6378	10	
	V6379	25	
	V6380	50	
	V6381	100	
	V6382	250	
	V6383	500	
	V6384	1000	
	V6385	2000	
ERLENMEYER FLASKS, GRADUATED NORMAL NECK - ISO 1773	V6420	25	
	V6421	50	
	V6422	100	
	V6423	250	
	V6424	500	
	V6425	1000	
	V6426	2000	
	V6427	3000	
V6428	5000		
ERLENMEYER FLASKS, GROUND GLASS NECK	V6430	25	
	V6431	50	
	V6432	100	
	V6433	100	
	V6434	250	
	V6435	500	
	V6436	1000	
	V6437	1000	
	V6438	2000	
	V6439	2000	
VOLUMETRIC PIPETTES, 1 LINE, QUALICOLOR CLASS B - ISO 648	V6560	1	
	V6561	2	
	V6562	5	
	V6563	10	
	V6564	20	
	V6565	25	
	V6566	50	
	V6567	100	
VOLUMETRIC PIPETTES, 1 LINE, QUALICOLOR CLASS A - ISO 648	V6560/A	1	
	V6561/A	2	
	V6562/A	5	
	V6563/A	10	
	V6564/A	20	
	V6565/A	25	
	V6566/A	50	
	V6567/A	100	

Laboratory glass and porcelain

WEIGHING BOTTLE INNER LID	32 x 40 mm	V2320 Complete V2320/1 Lid - 29/10 V2320/2 Body - 29/10	
WEIGHING BOTTLE INNER LID	40 x 25 mm	V2325 Complete V2325/1 Lid - 34/12 V2325/2 Body - 34/12	
WEIGHING BOTTLE INNER LID	44 x 20 mm	V2330 Complete V2330/1 Lid - 40/12 V2330/2 Body - 40/12	
WEIGHING BOTTLE INNER LID	50 x 40 mm	V2340 Complete V2340/1 Lid - 45/12 V2340/2 Body - 45/12	
WEIGHING BOTTLE INNER LID	60 x 40 mm	V2350 Complete V2350/1 Lid - 55/12 V2350/2 Body - 55/12	
WEIGHING BOTTLE OUTER LID	22 x 35 mm	V2360 Complete V2360/1 Lid - 24/10 V2360/2 Body - 24/10	
WEIGHING BOTTLE OUTER LID	28 x 35 mm	V2370 Complete V2370/1 Lid - 29/10 V2370/2 Body - 29/10	
WEIGHING BOTTLE OUTER LID	44 x 40 mm	V2380 Complete V2380/1 Lid - 45/12 V2380/2 Body - 45/12	
WEIGHING BOTTLE OUTER LID	54 x 40 mm	V2390 Complete V2390/1 Lid - 55/12 V2390/2 Body - 55/12	

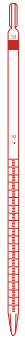

	Reference	Capacity mL	
GAY-LUSSAC LIQUID PYCNOMETER	V5560	10	
	V5561	25	
	V5562	50	
	V5563	100	
RENAULT SOLID PYCNOMETER	V5570	10	
	V5571	25	
	V5572	50	
	V5573	100	
LIQUID AND SOLID PYCNOMETER WITH POLYTHENE STOPPER	V5580	10	
	V5581	25	
	V5582	50	
	V5583	100	

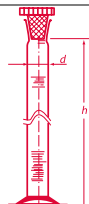
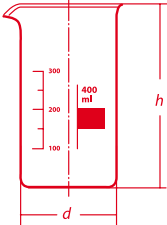
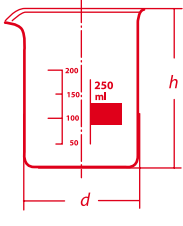
	Reference	Capacity mL	
DESICCATOR WITH SCREW-ON KNOB LID	V6160	100	
	V6161	150	
	V6162	200	
	V6163	250	
	V6164	300	
DESICCATORS WITH STOPCOCK	V6180	100	
	V6181	150	
	V6182	200	
	V6183	250	
	V6184	300	
GLASS FUNNELS	V6620	45	
	V6622	55	
	V6623	75	
	V6624	85	
	V6625	100	
	V6626	125	
	V6627	150	
	V6628	200	
	V6629	250	
	V6630	300	
RAPID FILTER FUNNELS	V6260	55	
	V6261	75	
	V6262	105	

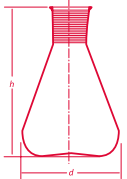
	Reference	Capacity mL	
VOLUMETRIC PIPETTES, 2 LINES, QUALICOLOR CLASS B - ISO 648	V6580	1	
	V6581	2	
	V6582	5	
	V6583	10	
	V6584	20	
	V6585	25	
	V6586	50	
	V8687	100	
VOLUMETRIC PIPETTES, 2 LINES, QUALICOLOR CLASS A - ISO 648	V6580/A	1	
	V6581/A	2	
	V6582/A	5	
	V6583/A	10	
	V6584/A	20	
	V6585/A	25	
	V6586/A	50	
	V8687/A	100	
GRADUATED CLOSED PIPETTES QUALICOLOR, CLASS B - ISO 835h	V6660	1 1/100	
	V6661	1 1/10	
	V6662	2 1/100	
	V6663	2 1/10	
	V6664	5 1/10	
	V6665	5 1/20	
	V6666	10 1/10	
	V6667	20 1/10	
	V6668	25 1/10	
	V6669	50 1/10	
	V6670	100 1/5	
GRADUATED CLOSED PIPETTES QUALICOLOR, CLASS A - ISO 835	V6660/A	1 1/100	
	V6662/A	2 1/50	
	V6665/A	5 1/20	
	V6666/A	10 1/10	
	V6667/A	20 1/10	
	V6668/A	25 1/10	
	V6669/A	50 1/10	
	V6670/A	100 1/5	
GRADUATED TEST TUBES WITH POLYETHYLENE STOPPER, HEXAGONAL BASE ISO 4788; DIN 12685-1	V6720	5	
	V6721	10	
	V6722	25	
	V6723	50	
	V6724	100	
	V6725	250	
	V6726	500	
	V6727	1000	
	V6728	2000	
	GRADUATED TEST TUBES WITH SPOUT, HEXAGONAL BASE ISO 4788; DIN 12685-1	V6740	
V6741		10	
V6742		25	
V6743		50	
V6744		100	
V6745		250	
V6746		500	
V6747		1000	
V6748	2000		
GRADUATED TALL BEAKERS WITH SPOUT ISO 3819; DIN 12331-1	V6780	25	
	V6781	50	
	V6782	100	
	V6783	150	
	V6784	250	
	V6785	400	
	V6786	600	
	V6787	800	
	V6788	1000	
	V6789	2000	
V6790	3000		
GRADUATED SHORT BEAKERS WITH SPOUT ISO 3819; DIN 12331-1	V6799	10	
	V6800	25	
	V6801	50	
	V6802	100	
	V6803	150	
	V6804	250	
	V6805	400	
	V6806	600	
	V6807	800	
	V6808	1000	
	V6809	2000	
	V6810	3000	
V6811	5000		

	Reference	Capacity mL	Female	
KITASATO VACUUM FLASKS, GROUND GLASS NECK	V6470	250	29/32	
	V6471	500	29/32	
	V6473	1000	29/32	
	V6474	1000	45/40	
	V6475	2000	29/32	
	V6476	2000	45/40	

	Reference	Diameter mm	
WATCH GLASSES	V6799	30	
	V6800	40	
	V6801	50	
	V6802	60	
	V6803	70	
	V6804	80	
	V6805	80	
	V6806	100	
	V6807	120	
	V6808	150	
	V6809	200	
V6810	250		

	Reference	Capacity mL	Female	
GRADUATED BURETTES, glass stopcock with strip ISO 835	V7750	10	1/10	
	V7751	25	1/10	
	V7752	50	1/10	
	V7753	100	1/5	
GRADUATED BURETTES, glass stopcock without strip ISO 835	V7755	10	1/10	
	V7756	25	1/10	
	V7757	50	1/10	
	V7758	100	1/5	

Porcelain

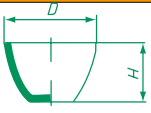
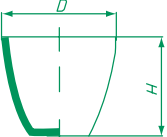
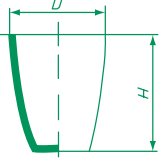
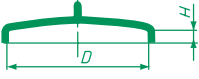
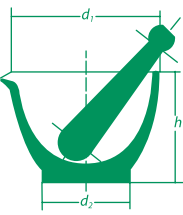
	Reference	Measurements Ø x h	Capacity mL.	
SHORT PORCELAIN CRUCIBLES	V8001/30	30 x 19	5	
	V8001/35	35 x 22	10	
	V8001/40	40 x 25	17	
	V8001/45	45 x 28	21	
	V8001/50	50 x 32	24	
MEDIUM PORCELAIN CRUCIBLES	V8002/35	35 x 28	12	
	V8002/40	40 x 32	20	
	V8002/45	45 x 36	30	
	V8002/50	50 x 40	45	
	V8002/60	60 x 48	80	
	V8002/70	70 x 56	120	
TALL PORCELAIN CRUCIBLES	V8003/30	30 x 38	15	
	V8003/35	35 x 44	26	
	V8003/40	40 x 45	35	
	V8003/45	45 x 56	50	
	V8003/50	50 x 62	72	
LIDS FOR CRUCIBLES	V8030	30 x 34	30 x 34	
	V8035	35 x 39	35 x 39	
	V8040	40 x 44	40 x 44	
	V8045	45 x 49	45 x 49	
	V8050	50 x 54	50 x 54	
	V8060	60 x 64	60 x 64	
	V8070	70 x 74	70 x 74	
PORCELAIN MORTARS WITH PESTLE	V8212/0	60 x 32	25	
	V8212/1	70 x 37	30	
	V8212/1a	81 x 42	50	
	V8212/1b	91 x 46	75	
	V8212/2	100 x 50	110	
	V8212/2a	113 x 56	150	
	V8212/3	125 x 64	220	
	V8212/3a	144 x 71	325	
	V8212/4	163 x 82	500	
	V8212/5	183 x 90	730	
	V8212/6	215 x 104	1135	
	V8212/7	257 x 127	2250	
	V8212/8	298 x 150	4300	

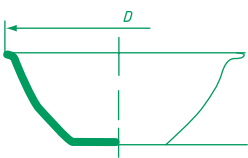
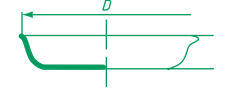
	Reference	Measurements Ø x h	Capacity mL.	
FLAT BOTTOM PORCELAIN DISHES	V8274/1	55 x 22	18	
	V8274/1a	70 x 30	45	
	V8274/2	85 x 32	75	
	V8274/3	97 x 40	120	
	V8274/4	110 x 50	200	
	V8274/5	125 x 52	275	
	V8274/6	140 x 55	375	
	V8274/7	150 x 63	475	
	V8274/8	167 x 68	660	
	V8274/9	195 x 75	1000	
V8274/9a	205 x 105	2500		
SHORT, FLAT BOTTOM PORCELAIN DISHES	V8208/1	60 x 10	20	
	V8208/2	70 x 15	30	
	V8208/3	80 x 20	50	
	V8208/4	100 x 25	100	
	V8208/5	130 x 30	250	

Laboratory furniture

Laboratory furniture for industrial research and application development in laboratories. Made of steel, wood or laminated plastic. All construction types are available in a wide range of sizes and internal configurations. Our technical staff will contact you to assess your needs in the light of the space available. This will allow us to draw up a floor design with specifications and drawings to give you a realistic idea of how your laboratory will look.



Mobile laboratories

The procedures required to perform a proper inspection covering large areas and achieve proper material control and testing is especially inconvenient for activities such as road construction. The PROETI mobile lab is the best solution for this kind of situation.

Typical equipment in the booth can consist of:

- Electrical and lighting installation.
- Cold/Hot air conditioning.
- Aluminium windows.
- Water tank.
- Furniture.
- Concrete, soil and asphalt testing equipment, etc.



NAME	PAGE	NAME	PAGE
• "In situ" density	• 249	• Dynamometric rings	• 358
• 501 – 502 – 503 DR	• 256	• Electro-mechanical universal testing machines	• 337
• Abrasion test	• 31	• Electronic scales	• 6
• Abrasive wear resistance test	• 33	• Erosionability	• 261
• Accelerated aggregate polishing	• 36	• ETIMATIC	• 114
• Adherence test – Beam Test	• 140	• Falling ball consistency	• 59
• Adhesion test with a Vialit plate	• 289	• Fatigue test	• 298
• Aggregate consistency	• 31	• Flakiness index and particle shape	• 25
• Air trapped in fresh concrete	• 90	• Flash point and ignition point	• 303
• Analysis of bitumen samples	• 272	• Flash point and ignition point	• 308
• Apparent and relative density. Absorption and specific weight	• 27	• Friability coefficient. Fragmentation resistance	• 35
• Automatic compaction	• 221	• Gilmore method	• 57
• Automatic computer-controlled machines	• 120	• Gravel-cement test	• 220
• Automatic extraction	• 279	• H0206/PLUS electromechanical multitest presses with digital display	• 239
• Ballast tests	• 49	• Hardness test	• 351
• Benchtop muffle furnaces	• 366	• Heating plates	• 13
• Bitumen distillation	• 304	• Heating plates	• 360
• Bitumens and bitumen binders	• 306	• Hoek cells for triaxial tests on rocks	• 47
• Bituminous grout abrasion	• 289	• Hubbard - Field method	• 287
• Bituminous grout consistency	• 289	• Immersion compression / simple compression bituminous mixtures	• 288
• Carbonate content of aggregates	• 30	• Impact test method	• 246
• CBR (California Bearing Ratio) test	• 225	• Indentation tests in cubic or Marshall specimens	• 290
• CBR tests "in situ"	• 246	• Laboratory furniture	• 373
• Centrifuging	• 277	• Laboratory glass and porcelain	• 370
• Change in soil volume	• 184	• Large capacity electronic scales	• 8
• Chemical products	• 368	• Load plate test	• 265
• Chemical soil analysis	• 179	• Machines have display of force on a pressure gauge	• 106
• Chemical tests	• 52	• Machines with digital display of force	• 108
• Classification of samples	• 167	• Machines with speed servo-control and digital force display	• 112
• Collecting specimens to test consistency and workability	• 84	• Magnetic stirring rods	• 360
• Compaction	• 94	• Marking and folding	• 344
• Compaction and CBR	• 217	• Marshall compaction	• 281
• Compaction and moisture	• 248	• Marshall test presses	• 283
• Compression machines	• 103	• MCM-2 Hydrotector	• 257
• Compression/Bending and Tensile tests	• 233	• MC-S-24 Strata	• 255
• Computer-controlled electromechanical multitest presses	• 240	• Mean coat thickness	• 321
• Computerised universal testing machines	• 324	• Measuring skid resistance on roads - Gryptester	• 320
• Computerised universal testing machines	• 329	• Mechanical precision scales	• 9
• Computerised universal testing machines	• 332	• Mechanical properties	• 32
• Concrete contraction test	• 140	• Mixing and temperature	• 280
• Concrete permeability and water absorption	• 139	• Mixing, molding, curing and breaking	• 69
• Consistency	• 54	• Mobile laboratories	• 373
• Consistency	• 55	• Moisture density – Nuclear method	• 255
• Contraction limit	• 175	• Moisture density – Nuclear method	• 256
• CV/PC electromechanical multitest presses with digital speed selector and display	• 238	• Moisture density – Nuclear method	• 257
• Cylinder specimen facing	• 102	• Moisture density – Nuclear method	• 250
• Density - Nuclear method	• 314	• Multitest electromechanical presses	• 233
• Density moisture–Nuclear method–MC-1-DRP	• 254	• Non-destructive tests	• 141
• Determination of linear contraction	• 175	• Occluded air and density	• 64
• Determination of liquid limit	• 173	• Optional triaxial test settings	• 212
• Determination of particle density	• 175	• Particle size distribution	• 178
• Determination of particle density	• 176	• Pavement tests	• 318
• Determination of plastic limit	• 174	• Penetration	• 306
• Determination of sand equivalent	• 177	• Platform scales	• 9
• Determining cement fineness	• 53	• Porcelain	• 372
• Determining cement strength	• 75	• Potential alkali reactivity of cement aggregates	• 30
• Determining clay, silt and dust content in aggregates	• 26	• Presses for CBR tests	• 227
• Determining indirect tensile strength	• 286	• Presses for compression tests	• 104
• Determining moisture content	• 171	• Pressure and distributor display panels	• 201
• Determining water sensitivity of bitumen mixtures	• 287	• Pressure filter method	• 273
• Determining weight loss	• 302	• Pressure regulation panels:	• 203
• Dial indicators	• 358	• Proetisa Nuclear Area	• 258
• Direct shear test and Vane test	• 185	• Quantitative extraction	• 275
• Drying ovens	• 11	• Quick drying methods	• 14
• Drying ovens	• 12	• Resilience test	• 347
• Ductility and rupture point	• 312	• Resistance to plastic deformation	• 291
• Duriez test	• 288	• Resistance to water	• 290
• Dynamic penetration test	• 267	• Rock classification	• 46

NAME	PAGE
• Rock mechanics	• 41
• Rock samples	• 38
• Roller compaction	• 299
• Rotating compactor	• 301
• Sample curing	• 74
• Sample extraction	• 318
• Sample extractors	• 169
• Sample preparation	• 16
• Sample preparation	• 168
• Samples, preparation and tests	• 302
• Sampling	• 52
• Sampling	• 166
• Servo-pneumatic Testing System	• 293
• Sets of weights	• 10
• Sieving machines	• 23
• Skid resistance coefficient	• 37
• Softening point	• 305
• Software for CBR and Marshall tests	• 232
• Software for geotechnical tests	• 209
• Software for geotechnical tests	• 211
• Soil consolidation	• 182
• Soil permeability	• 259
• Soil-cement test	• 220
• Solvent recovery	• 280
• Specific weight	• 89
• Specimen curing	• 95
• Specimen cutting and grinding	• 101
• Specimen preparation	• 91
• Specimen preparation	• 92
• Specimen recovery method using volume calculation	• 290
• Specimen removal	• 100
• Stability and expansion	• 60
• Stirrers	• 181
• Temperature	• 313
• Temperature	• 361
• Temperature control during the test	• 295
• Tests to determine the geometric properties of aggregates.	
Flow assessment	• 26
• Texture	• 321
• Thermometers	• 368
• Thermostatic baths	• 359
• Triaxial press	• 193
• Triaxial test	• 191
• Triaxial test pressure systems	• 207
• Trimming machines	• 170
• Ultrasound	• 345
• Unconfined compression test	• 264
• Universal servo-hydraulic systems	• 296
• Vibrating hammer compaction	• 225
• Viscosity and consistency	• 309
• Weld control	• 346
• Wet sieving	• 20
• Wheel Tracker Machine	• 291

NAME	PAGE	NAME	PAGE
• 932/1; UNE EN 196-2	• 52	• BS 812	• 28
• ASTM C 117; BS 812	• 26	• BS 812; NF P18-574	• 32
• ASTM C 403; AASHTO T 197	• 87	• D3148, D2938, D5407, D2664	• 41
• ASTM C109	• 80	• EN 10002-1; DIN 50.125 y UNE 7184	• 324
• ASTM C109; AASHTO T132	• 72	• EN 10045/1 – UNE 7475 – ASTM E23 – DIN 50115	• 347
• ASTM C1362	• 87	• EN 101	• 46
• ASTM C141, C151; UNE 80113.	• 61	• EN 1015-19, UNE EN 1015-21	• 68
• ASTM C185 – AASHTO T 137	• 64	• EN 1015-3; EN 459-2	• 58
• ASTM C215, C666; BS 1881:209; NF P18-414	• 152	• EN 1015-9	• 66
• ASTM C230; BS 4551	• 58	• EN 1097-1; UNE 83.115; AFNOR P18.572; NF P18-576	• 35
• ASTM C230; BS 4551	• 58	• EN 1097-2; NLT 325; ASTM C131, C535; AASHTO T 96; NF18-573	• 31
• ASTM C360	• 87	• EN 1097-3; NLT 156; ASTM C29; BS 812	• 28
• ASTM C426, BS 1881	• 144	• EN 1097-4; NLT 177; BS 812	• 29
• ASTM C490, C348; BS1 881, 6073; NF P 18-427; UNE 80113.	• 61	• EN 1097-6; UNE 7140, 7083, 83.133; ASTM C128, C127; AASHTO T84; BS 812; NLT 154; DIN 12039	• 27
• ASTM C684, BS 1881-112	• 96	• EN 1097-7; NF P18-558; BS 812; NLT 155	• 27
• ASTM C70; AASHTO T142	• 29	• EN 1097-8; EN 13036-4; NLT 175; ASTM E303; BS 812:114; NF P15-578	• 37
• ASTM C70; AASHTO T142	• 172	• EN 1097-8; NLT 174; BS 812:114; NF P18-575; ASTM E303	• 36
• ASTM C803; BS 1881	• 143	• EN 1097-8; UNE EN 1342; ASTM C131, C535; BS 812-3	• 34
• ASTM C91, C110	• 68	• EN 12350-10	• 85
• ASTM C91, C141, C266; AASHTO T 154	• 57	• EN 12350-12	• 85
• ASTM D 140; AASHTO T40	• 302	• EN 12350-2; INFORME RILEM N°23	• 84
• ASTM D 1558	• 248	• EN 12350-2; UNE 7103, 83313; ASTM C143; AASHTO T119; BS 1881; DIN 1048; NF P18.305	• 84
• ASTM D 2167; AASHTO T205	• 248	• EN 12350-3; UNE 83.314; NLT-308; BS 1881:104	• 86
• ASTM D 2172; AASHTO T164	• 276	• EN 12350-4; DIN 1048	• 86
• ASTM D 5873	• 46	• EN 12350-5; BS 1881-105; DIN 1048	• 86
• ASTM D 5873	• 47	• EN 12350-7; UNE 7141, ASTM C231: BS 1881-106; DIN 1048	• 90
• ASTM D 940, D 1655 – AASHTO T54 – BS 2000 – CNR N° 102 – NF T66-020	• 309	• EN 12350-9	• 85
• ASTM D1310, D3143	• 308	• EN 12390/3	• 101
• ASTM D1883; AASHTO T193; BS1377,1924; LCPC	• 246	• EN 12390-1; EN 196-1	• 79
• ASTM D2573; BS 1377	• 264	• EN 12390-2	• 91
• ASTM D2937; CNR N°22; BS 1377:9	• 166	• EN 12390-5, EN 1340, UNE 83305; ASTM C78; AASHTO T97; BS 1881; NF P18-407; DIN 5 1227	• 137
• ASTM D3148, D2938, D5407, D2664	• 130	• EN 12390-6; ASTM C446; NF P18-408	• 127
• ASTM D36, E28; IP58; DIN 52011; EN 1427; NFT 66008; ISO 4625	• 305	• EN 12504-1	• 100
• ASTM D4123; BS DD 226; EN 12697 -26; BS DD 213; EN 12697- 24; ASTM D3497; AASHTO TP31; EN 12697 -25; AASHTO TP8; ASTM D3999; AASHTO P46; ASTM D5311; AASHTO T307	• 296	• EN 12504-3	• 148
• ASTM D420, D1452; AASHTO T86, T202	• 166	• EN 12607-1	• 303
• ASTM D4428-D4428M-00	• 163	• EN 12697- 24, 12697- 25, EN 12697- 26; ASTM D4123, D3497; AASHTO TP31, TP8, TP62, TP46, T307; BS DD 226; NCHRP 1-28A	• 293
• ASTM D4429; BS 1377	• 246	• EN 12697-1, EN 13108 - LCPC - CNR N.38	• 277
• ASTM D4944; AASHTO T217; UNE 7804; BS 6576	• 171	• EN 12697-22; BS 598: Part 110: 1996; Austroads 01:2004	• 291
• ASTM D5607 – ISRM	• 45	• EN 12697-23; ASTM D4123	• 242
• ASTM D6938; D2922; D2950; D3017; BS 1377	• 314	• EN 12697-24, EN 12697-26; AASTHO TP8	• 298
• ASTM D6938; D2922; D2950; D3017; BS 1377	• 316	• EN 12697-34; ASTM D1559; BS 598; NF P 98-251	• 242
• ASTM D6938-08, D2922, D2950, D3017; BS 1377	• 252	• EN 1290, EN 12.062-02	• 346
• ASTM D6938-08, D2922, D2950, D3017; BS 1377	• 254	• EN 13075-1	• 306
• ASTM D6938-08, D2922, D2950, D3017; BS 1377	• 255	• EN 13286-2; UNE 7365, 7255, 103-501/94; NLT-107/91, 107/98, 108/91, 108/98; ASTM D698, D1557, D1833; AASHTO T99, T180, T193; BS 1377:4, 1994; NF P94-093, P94-066; DIN 18127; DUTCH RAW, EPP	• 217
• ASTM D698, D1587, D1883; BS 598, 1377.	• 169	• EN 13286-2; UNE 7365, 7255, 103-501/94; NLT-107/98, 108/98; ASTM D698, D1557, D1833; CNR N° 29,69; AASHTO T99, T180, T193; BS 1377:4, 1994; NF P94-093, P94-066; DIN 18127; DUTCH RAW, EPP	• 221
• ASTM D698, D1587, D1883; BS 598, 1377.	• 169	• EN 13286-46; BS 1377	• 247
• ASTM D88, D244 - AASHTO T72 - UNE 7066, 51021- NLT-133, 138	• 310	• EN 13286-47, EN 13286-4; UNE 103-502; NLT-111/87; ASTM D1883/73; AASHTO T193; BS 1377:4, 1924:2; NF P94-078, P94-093, P98-231	• 225
• ASTM DZ166; BS 1377; AASHTO T208	• 264	• EN 13286-47, UNE 103-502; NLT-111/87; ASTM D1883/73; AASHTO T193; BS 1377:4, 1924:2; NF P94-078	• 242
• ASTM E11	• 24	• EN 13286-47; EN 196-1 UNE 103-502, 67100-85, 7035, 7060, 7090-73, 7184, 7194; NLT-111/87, 150/73, 202/72, 160/73; ASTM D1833; AASHTO T193; BS 1377:4; NF P94-078	• 233
• BS 1191; UNE 6782	• 63	• EN 13286-47; UNE 103-502; NLT-111/87; ASTM D1833; AAS HTO T193; BS 1377:4; NF P94-078	• 227
• BS 1377	• 178	• EN 13286-5	• 247
• BS 1377	• 179		
• BS 1377	• 189		
• BS 1377, 1924	• 176		
• BS 1377, 1924	• 249		
• BS 1377:2	• 175		
• BS 1377:2	• 176		
• BS 1377; ASTM D1067	• 180		
• BS 1377; ASTM D2850	• 243		
• BS 1881 part 103, 5075	• 86		
• BS 4550	• 73		
• BS 4551-1, 6463-4	• 59		
• BS 812	• 25		

NAME	PAGE	NAME	PAGE
• EN 13395-2	• 66	• NLT 207/98; ASTM D4647; BS 1377	• 261
• EN 1341, 1342,1343; UNE EN 1339, 10545-6; UNE 13748-2	• 33	• NLT 335; ASTM E965; BS 598: Part 105	• 321
• EN 1367-2; NLT 158; ASTM C86	• 31	• NLT 354; BS 812	• 29
• EN 1367-4, 12617-4; ASTM C151; C490 ; NF P15-433; P18-427; BS 1881-5, 6073, 812: 102; DIN 1164	• 62	• NLT 356; AASHTO T256: S.N.V.	• 319
• EN 1367-4; BS 812:102	• 29	• NLT 371; ASTM D 3910-84	• 289
• EN 1542, 12504-3; ASTM C900; BS 1881:207	• 146	• NLT-107, 108, 111, 59; AASHTO T-99; ASTM D698, D1557, D1883	• 224
• EN 196/1, 196/3, 413/2, 459/2; ISO 679; ASTM C305; AASHTOT 162	• 69	• NLT-117/72	• 180
• EN 196/1, 196/3, 413/2, 459/2; ISO 679; NF P15-413, P18-401; ASTM C109, 348; AASHTO T 106; BS 4550	• 72	• NLT-118/72	• 180
• EN 196/1; ASTM C109; BS 3892; DIN 1164; NF P18-411; AS 2350	• 75	• NLT-124; BS 1377; NF P94-052/1	• 174
• EN 196/1; ASTM C348	• 243	• NLT-125; ASTM D36, E28; AASHTO T53; DIN 52011; EN 1427	• 305
• EN 196/1; ASTM C349; NF P15-451; PR EN/ISO 679	• 79	• NLT-185, 186; ASTM D2872; AASHTO T240	• 303
• EN 196/1; ASTM C87, C109, C190, C191; UNE 80102	• 74	• NLT-189	• 304
• EN 196/1; ISO 679	• 74	• NLT-301/72, 302/72, 303/72	• 220
• EN 196/1; NF P15-413; ISO 679; BS 3892; D.M. 3/6/68	• 73	• NLT-310, 311; BS 1377, 1924	• 225
• EN 196/3; D.M. 3/6/68; ASTM C191; DIN 1164 1168; BS 4550; NF P15-414; P15-431; AASHTO T131	• 55	• NLT-310/90	• 220
• EN 196/6; NLT 157; ASTM C91, C110	• 67	• Norma Método francés LCPC	• 88
• EN 196/6; UNE 83.103; NLT 155; ASTM C188; AASHTO T 133; BS 4550	• 66	• TP 68-04; ASTM D 7113-05	• 317
• EN 196/7; UNE 80.401; ASTM C 183; AASHTO T127	• 52	• UNE 102032	• 67
• EN 196/8 – ASTM C 186 – BS 4550, 1370 – DIN 1164	• 63	• UNE 103 807	• 266
• EN 196; ASTM C190, C348, C349; DIN 1164.	• 81	• UNE 103.200: NLT 116	• 30
• EN 196-3; ASTM C187, 191; BS 4550; AASHTO T131; NF P15-414 P15-431; DIN 1168	• 54	• UNE 103.302; ASTM 854; ASTHO T100; BS 1377:2	• 28
• EN 196-3; UNE 80.103; EN ISO 9597; BS 6463; NF P15-4362	• 60	• UNE 103.400; ASTM D698, D1587, D1883; BS 598, 1377	• 170
• EN 196-6; UNE 80.122; ASTM C 204; BS 4359; NF P-15 442; AASHTO T153	• 53	• UNE 103102; ASTM D422; AASHTO T88; BS 1377	• 178
• EN 22719 – ASTM D93 – AASHTO T73, IP 34, 35 – ISO 2719	• 310	• UNE 103-103/94; NLT-105/91; ASTM D4318; BS 1377:2; AASHTO T89; NF P94-051	• 173
• EN 413-2, 459-2, 1015-4.	• 57	• UNE 103108; ASTM D427; BS 1377; AASHTO T92; NF P94-060-1	• 175
• EN 413-2; AFNOR P18-452	• 59	• UNE 103-204-93	• 180
• EN 455; NF P18-358, P18-507	• 67	• UNE 103308, 7391	• 265
• EN 459/1 – BS 890, 1191	• 62	• UNE 103-400	• 170
• EN 459/2	• 62	• UNE 103401; 103405	• 189
• EN 459/2	• 62	• UNE 103401; ASTM D3080; BS 1377	• 185
• EN 459/2	• 63	• UNE 103403; BS 1377	• 259
• EN 459-2	• 57	• UNE 103-403; BS 1377:5; ASTM D2434; AASHTO T215	• 259
• EN 933/1, 933/2 – UNE 7050/3, 7050/4 –	• 16	• UNE 103-405: ASTM D2435, D4546; BS 1377:5; AASHTO T216; NF P94090-1, P94-091	• 182
• EN 933-3; NF P18-561	• 25	• UNE 103-503; NLT 109; ASTM D 1556; AASHTO T191; NF P94061-3	• 249
• EN 933-4	• 29	• UNE 103600	• 184
• EN 933-4; DIN 4226; CNR 95	• 29	• UNE 127.005	• 33
• EN 933-6	• 26	• UNE 51023; NLT-127; ASTM D92; AASHTO 48; BS 4689; IP 36/67	• 308
• EN 933-9; NF P94-068; NF P18-592	• 26	• UNE 7045/32	• 176
• EN 933-9; NLT-171/86; NF P18-592	• 261	• UNE 7134; ASTM C235	• 32
• EN 938-8, UNE 103109; NLT-113/72; ASTM D2419; BS 1924; AASHTO T176; AFNOR P18-598	• 177	• UNE 7308; ASTM D3550, D1587; NI-ISSMFE	• 267
• EN 96; UNE 146.507, 146.507-1; ASTM C289	• 30	• UNE 77305; BS 1377; ASTM D1067	• 179
• EN UNE 1097-6; NLT 153/92	• 27	• UNE 83.311; ASTM C 403; AASHTO T 197	• 88
• ISO 3310/1, 3310/2, 9044 - BS 410 DIN 4187 – NF	• 16	• UNE 83112; BS 812:110	• 32
• NF P15-434	• 68	• UNE 83120	• 38
• NF P18-401	• 73	• UNE 83318; ASTM 490; BS 1881	• 140
• NF P18-452	• 88	• UNE EN 1015/7; EN 413/2, 459/2, - UNE 83.815 - DIN 18.555	• 64
• NF P18-577	• 36	• UNE EN 12272-1; BS 594	• 321
• NF P94-061-2	• 248	• UNE EN 12272-3; NLT 313; LCPC	• 289
• NLT – 155	• 282	• UNE EN 12274-5; NLT 320/87; ASTM D 3910	• 289
• NLT – 251; ASTM D 4644	• 39	• UNE EN 12350-5; ASTM C124; AASHTO T120	• 89
• NLT – 252; ASTM D5731	• 40	• UNE EN 12350-6; UNE 7286, 83.317; ASTM C29, C138; BS 812, 1881, AASHTO T19	• 89
• NLT – 327	• 321	• UNE EN 12390, EN 10002.2; ASTM C42; BS 1610	• 129
• NLT 122; ASTM D70; AASHTO T22; ISO 3838; BS 4699	• 302	• UNE EN 12390-1; UNE EN 12390-2; UNE 7240; DIN 51.229; ASTM C31, C192; AASHTO T23, T97; BS 1881-108; NF 18-401	• 92
• NLT 155; ASTM C188, C189; BS 812	• 302	• UNE EN 12390-2; ASTM C31, C 192; AASHTO T23, T126; BS 1881:108	• 94
• NLT 160; ASTM D 1138; AASHTO T 169	• 287	• UNE EN 12390-2; EN 196; AASHTO T23; ASTM C31, C192; BS 1881-111	• 95
• NLT 162, 160; ASTM D 1047; AASHTO T 167	• 288	• UNE EN 12390-2; EN 196; ASTM C31, C192	• 96
• NLT 162, 160; ASTM D 1047; AASHTO T 167	• 288	• UNE EN 12390-3, 12390-4; UNE 7281, UNE 83304; ASTM C39, E4, BS 1610; AASHTO T22, T71; DIN 51.220, 51.223; NF P18-411; BS 1610	• 104
• NLT 169/72	• 277		
• NLT 183; ASTM D139; AASHTO T50	• 311		
• NLT 196/84, 321/84/89	• 290		
• NLT 197	• 311		

NAME	PAGE
• UNE EN 12390-3, UNE 7240, 83303; ASTM C617; NF P18-416; BS 1881; AASHTO T23, T126	• 102
• UNE EN 12390-8, EN 12364; DIN 1048; ISO 7031; ENV 206	• 139
• UNE EN 12504-2; DIN 1048; ASTM C805; BS 1881; NF P18-417	• 141
• UNE EN 12593; NLT 182; CNR IP-80; DIN 5201	• 312
• UNE EN 12607-2; 13303; NLT-128, 147; UNE 104.281;	•
ASTM D6, D1754; AASHTO T179; BS 2000	• 302
• UNE EN 12607-3, 12697-3; NTL 347	• 274
• UNE EN 12618-2; EN 1542; UNE EN 12504-3	• 147
• UNE EN 12697-1, 12697-14; NLT-137; BS 598	• 274
• UNE EN 12697-1; BS 598	• 273
• UNE EN 12697-1; BS 598, 5284	• 272
• UNE EN 12697-1; DIN 1996	• 273
• UNE EN 12697-1; DIN 1996; CNR a. VII. 38	• 279
• UNE EN 12697-1; NLT 164; ASTM D2172; AASHTO T164	• 275
• UNE EN 12697-1; NLT 164; DIN 196; CNR a. VII N.38.	• 276
• UNE EN 12697-10, 12697-30; NLT 159; ASTM D 1559; BS 598	• 281
• UNE EN 12697-10, 12697-31	• 301
• UNE EN 12697-12	• 287
• UNE EN 12697-18 - EN 13108	• 287
• UNE EN 12697-20	• 290
• UNE EN 12697-20	• 290
• UNE EN 12697-23; ASTM D4123; CNR N.134	• 286
• UNE EN 12697-32	• 282
• UNE EN 12697-33	• 299
• UNE EN 12697-34, UNE 103-502; NLT-111; ASTM D1559; AASHTO T245; NF P98/251/2 CNR N°30	• 283
• UNE EN 12697-39; AASHTO T164; NLT384/00; ASTM T 308-99	• 278
• UNE EN 12697-5, 12697-12; ASTM D 2041	• 274
• UNE EN 1289/1M:2002	• 347
• UNE EN 13036-7	• 318
• UNE EN 13302; NLT 375; ASTM D3205, 4402; CEN TC 19	• 311
• UNE EN 13358; NLT 134; UNE 7.112; ASTM D402; AASHTO T78	• 304
• UNE EN 13398; NLT 329	• 313
• UNE EN 13589; 13398; NLT 126; UNE 7093; ASTM D113; AASHTO T51; CNR N.44 PR-EN	• 312
• UNE EN 1367-1; UNE EN 10345-12	• 99
• UNE EN 13748-1	• 87
• UNE EN 1426; NLT 124; UNE 104281-1-4; ASTM D5, D217; AASHTO T49; BS 2000	• 306
• UNE EN 1430; NLT 194; ASTM D 244; AASHTO T59	• 313
• UNE EN 1431; NLT-139; ASTM D244; AASHTO T59	• 304
• UNE EN 1714	• 345
• UNE EN 1744-1	• 38
• UNE EN 1744-1	• 40
• UNE EN 196-2:1996	• 65
• UNE EN 451-2; DM 3/6/68	• 53
• UNE EN 932-1; NLT 148/91; ASTM C136, C702, D271, D421, D492; AASHTO T27, T87; BS 1377, 812	• 167
• UNE EN 933-1	• 21
• UNE EN 933-1	• 22
• UNE EN 933-10	• 23
• UNE EN ISO 10545-2	• 34
• UNE EN ISO 10545-7/1996	• 34
• UNE EN ISO 6506-1; ASTM E10-66; AFNOR NF-A03; ISO R156	• 354
• UNE EN ISO 6508	• 351
• UNE EN ISO 6508	• 352
• UNE EN ISO 7438, UNE 36068; ASTM A615	• 344
• UNE103-104/93; NLT-106/72; ASTM D 427; BS 1377; AASHTO T9	• 174
• UNE103-104/93; NLT-106/72; ASTM D4318; BS 1377; AASHTO T90	• 175
• X11-504 – AASHTO T27 - ASTM E11	• 16

NAME	PAGE	NAME	PAGE
• "L" box test	• 85	• Brick facing machine	• 128
• "In situ" density test using the sand method	• 249	• Brinell hardness testing machines	• 354
• "In situ" density test using the sand replacement method	• 249	• Brush for cleaning laboratory material	• 366
• "J" ring test	• 85	• Bunsen burner with air and gas control knob	• 365
• Abrams cone	• 84	• Cabinet type ovens	• 12
• Abrasion meter	• 34	• Calibrated volumetric containers	• 89
• Accessories for nuclear equipment	• 258	• Calibration instruments	• 138
• Accessories for testing machines	• 119	• Calorimeter	• 63
• Accessories needed to computerise the consolidation equipment	• 184	• Casagrande method	• 173
• Accessories needed to computerise the direct shear equipment	• 188	• CBR (California Bearing Ratio) test	• 242
• Aggregate consistency	• 32	• CBR /Marshall motor-driven press, 50 kN capacity. Version ASTM – two speeds 1.27 - 50.8 mm/min	• 228
• Aggregate Density – Non-nuclear Method	• 317	• CBR /Marshall motor-driven press, 50 kN capacity. Version BS – two speeds 1 - 50.8 mm/min	• 228
• Air / Water cell tray	• 200	• CBR "in-situ" testing equipment	• 246
• Air / water system	• 207	• CBR moulds	• 225
• Air jet sieving machine	• 23	• CBR press displays	• 230
• Alkalinity, chlorides and water hardness	• 180	• CBR test	• 232
• Analytical scales	• 6	• CD - Consolidated, drained test.	• 192
• Anti-vibration table for scales	• 8	• Cement bending test	• 234
• Apparatus for determining fly ash by wet method	• 53	• Cement compression test	• 234
• Apparatus for measuring hydraulic contraction in concrete	• 140	• CENT – 0 - GRAM SCALES	• 9
• Apparatus for testing the slump of paste	• 66	• Centrifuge extracting machine with 1500 g capacity	• 275
• Apparatus for testing tile impact resistance	• 87	• Centrifuge extracting machine with capacity for 3000 g	• 275
• Apparatus to determine apparent density	• 62	• Certified triple mold for 40 x 40 x 160 mm specimens	• 72
• Apparatus to determine moisture conditions and crushing value	• 247	• Charpy pendulums	• 348
• Apparatus to determine residue by means of water flow	• 53	• Circular bath equipped with thermostat	• 168
• Apparatus to determine the roughness coefficient	• 41	• Circular heating plates	• 13
• Apparatus to determine water permeability.	• 68	• Circular heating plates	• 360
• Apparent density of aggregates	• 28	• Cleveland Apparatus	• 308
• Asphalt emulsion distillation residue	• 304	• Coarse aggregate density using the water displacement	• 28
• Autoclave	• 61	• Coarse aggregate relative density test	• 27
• Autographic device for non-confined simple compression tests	• 264	• Compact machine of 2000 kN capacity, controlled by ETIMATIC	• 117
• Automatic ball and ring apparatus	• 305	• Compact machine with 1500 kN capacity, controlled by ETIMATIC	• 116
• Automatic bitumen extractor	• 279	• Compact machine with 3000 kN capacity, controlled by ETIMATIC	• 117
• Automatic laboratory mixer	• 70	• Compact machine with 5000 kN capacity, controlled by ETIMATIC	• 118
• Automatic mortar compactor	• 73	• Compaction factor equipment	• 86
• Automatic press of 6000 kN capacity	• 125	• Compaction hammer	• 198
• Automatic press with 2000 kN capacity	• 124	• Complete ball and ring apparatus	• 305
• Automatic press with 3000 kN capacity	• 124	• Complete workability period unit	• 66
• Automatic press with 5000 kN capacity	• 125	• Compression and bending test in mortar specimens	• 243
• Automatic scales	• 9	• Compression test for prefabricated materials	• 234
• Automatic servo-controlled press with double piston test frame of 300/15 kN capacity for compression and bending strength tests.	• 76	• Compression test machine for pipes	• 137
• Automatic Vicat apparatus	• 55	• Compression test machines, capacity 1200 kN	• 106
• Bacon sampler	• 302	• Compression test machines, capacity 1500 kN	• 106
• Ballast sieves	• 49	• Compression test machines, capacity 1500 kN	• 108
• Bar bending machine with auto-programmable automaton	• 344	• Compression test machines, capacity 1500, 2000 and 3000 kN	• 109
• Bar cutter	• 344	• Compression test machines, capacity 2000 kN	• 106
• Baroid Kit	• 262	• Compression test machines, capacity 2000 kN	• 108
• Baroid mud pressure filter	• 263	• Compression test machines, capacity 3000 kN	• 107
• Baroid scale	• 262	• Compression test machines, capacity 3000 kN	• 108
• Barton perthometer	• 46	• Compressometer	• 126
• Base adapter	• 196	• Compressometer-extensometer	• 126
• Baskets and accessories	• 31	• Computer control via ETIWIN software	• 236
• Bending device	• 127	• Computerised direct shear equipment	• 188
• Bending test machine	• 128	• Computerised universal testing machine, 10 kN capacity	• 335
• Bending tests for terrazos, roof tiles, floor tiles, curbs, soil-cement specimens, clay blocks, prism specimens, natural rocks and prefabricated elements	• 243	• Computerised universal testing machine, 100 kN capacity	• 336
• Benkelman beam	• 319	• Computerised universal testing machine, 1000 kN capacity	• 327
• Bernard calcimeter	• 30	• Computerised universal testing machine, 1000 kN capacity	• 331
• BH rebar detector	• 150	• Computerised universal testing machine, 20 kN capacity	• 335
• Bitumen measuring instruments	• 272	• Computerised universal testing machine, 200 kN capacity	• 336
• Bituminous grout abrasion machine	• 289	• Computerised universal testing machine, 2000 kN capacity	• 327
• Blaine Permeability Meter	• 53	• Computerised universal testing machine, 300 kN capacity	• 336
• Bolt removal equipment	• 146	• Computerised universal testing machine, 400 kN capacity	• 327
		• Computerised universal testing machine, 5 kN capacity	• 334

NAME	PAGE	NAME	PAGE
• Computerised universal testing machine, 50 kN capacity	• 335	• Devices for rocks	• 45
• Computerised universal testing machine, 600 kN capacity	• 327	• Dial indicators	• 358
• Computerised universal testing machine, 600 kN capacity	• 331	• Diameter deformation measuring device	• 126
• Computerised, programmable automatic mixer	• 71	• DI-CP/V2 testing frame	• 325
• Concrete esclerometer	• 141	• Dietrich - Frühling calcimeter	• 30
• Concrete penetrometer	• 88	• Digilert 100 radiation monitor	• 251
• Concrete pocket penetrometer	• 87	• Digital Display Module UDI 14/2	• 77
• Concrete water penetration test	• 139	• Digital display with microprocessor	• 105
• Cone penetrometer method	• 174	• Digital esclerometer	• 142
• Cone pycnometer method	• 175	• Digital Force Display Module with Microprocessor UDI 16/4 PLUS	• 77
• Consistency of bituminous grout with cone	• 289	• Digital Force Display Module with Microprocessor UDI 16/4 PLUS	• 231
• Consolidation cells	• 182	• Digital hardness testing machines	• 355
• Consolidation cells	• 182	• Digital Pensky-Martens Viscometer	• 310
• Consolidation workbench	• 189	• Digital point load unit	• 40
• Constant and variable load combination permeameter, with 6 work stations	• 260	• Direct/residual shear apparatus	• 185
• Constant and variable load combination permeameter, with four work stations	• 260	• Distiller for the recovery of the solvent	• 280
• Constant load permeameter	• 259	• Dorry Machine	• 34
• Constant load spray device	• 290	• Double-ended flat microspatula	• 364
• Constant pressure hydraulic system for Hoek cells	• 48	• Drainage kit	• 199
• Continuous flow centrifuge	• 276	• Ductility and rupture point	• 313
• Contraction limit equipment	• 175	• Ductilometer	• 312
• Control and adjustment of speed, force and displacement speed	• 236	• Duriez test	• 288
• Control and measurement system	• 326	• Dynamic load plate test.	• 266
• Conversion frame for the CBR test in a laboratory.	• 246	• Dynamometers	• 9
• Corer with petrol motor	• 100	• Dynamometric rings	• 358
• Cover and bottom	• 20	• Elasticity software	• 44
• Crack measurements	• 143	• Electric air entrainment meter, capacity 1 l	• 64
• Crushing resistance	• 32	• Electric sample extractor probe	• 318
• CU - Consolidated, undrained test	• 192	• Electric vessel for melting sulphur	• 102
• Cubic mold for 70.7mm samples	• 73	• Electrical corer	• 100
• Cubic specimen trimming machine	• 170	• Electrical laboratory mixer	• 69
• Culatti micro-whisk mill	• 39	• Electromagnetic sieve shaker	• 22
• Curved double-ended spatulas	• 364	• Electromechanical multitest press, 100 kN capacity	• 238
• Cylinder method	• 176	• Electromechanical multitest press, 100 kN capacity	• 240
• Cylinder specimen trimming machine	• 170	• Electromechanical multitest press, 200 kN capacity	• 238
• Data acquisition unit with 16 channels	• 208	• Electromechanical multitest press, 200 kN capacity	• 238
• Data collection application	• 209	• Electromechanical multitest press, 200 kN capacity	• 239
• Data collection application (continued)	• 210	• Electromechanical multitest press, 200 kN capacity	• 239
• Data control and processing by PROETI computer (CPC)	• 330	• Electromechanical multitest press, 200 kN capacity	• 241
• Data storage system	• 97	• Electromechanical multitest press, 200 kN capacity	• 241
• Densitometer sedimentation method	• 178	• Electromechanical multitest press, 300 kN capacity	• 241
• Density - Nuclear method	• 314	• Electromechanical multitest press, 300 kN capacity	• 241
• Density - Nuclear method - MC - 1 - DRP	• 316	• Electromechanical multitest press, 50 kN capacity	• 238
• Density method for determining air content in mortar mixtures	• 64	• Electromechanical multitest press, 50 kN capacity	• 239
• Determination of drying shrinkage	• 29	• Electromechanical multitest press, 50 kN capacity	• 240
• Determination of pH	• 179	• Electro-mechanical universal testing machines	• 332
• Determination of soil porosity	• 176	• Electro-mechanical universal testing machines	• 333
• Determination of the sulphate content by the ion exchange method	• 179	• Electronic measurement systems and digital displays for CBR, CBR/Marshall and Multispeed presses	• 230
• Determination of voids in filler	• 29	• Electronic scale. Humidity determination. 200 g Sensitivity 0.001g.	• 14
• Determining flakiness index	• 25	• Electronic scales I	• 6
• Determining moisture content	• 28	• Electronic scales II	• 7
• Determining particle density and water absorption	• 27	• Electronic scales III	• 7
• Determining particle shape	• 25	• Engler Digital Viscometer	• 309
• Determining the elasticity modulus, Poisson coefficient and shear modulus	• 41	• Engler Digital Viscometer, 2 specimens	• 309
• Determining water sensitivity of bitumen mixtures	• 287	• EPOCH ultrasound fracture and defect detector.	• 346
• Determining weight loss	• 302	• Equipment for distilling fluidified bitumen	• 304
• Deval machine	• 36	• Equipment for manual determination of cationic emulsion rupture values	• 306
• Device for bending tests	• 80	• Equipment for measuring skid resistance	• 320
• Device for compression tests on cubes measuring 50 mm with 2" sides	• 80	• Equipment for measuring the apparent density of cement	• 67
• Device for kerb bending tests	• 128	• Equipment for the mix test	• 262
• Device for testing removal of electrowelded wire mesh	• 331	• Equipment required	• 132
• Devices for compression tests on specimens measuring 40 x 40 x 160 mm	• 79	• Equipment to determine relative density.	• 247
		• Equipment to determine sand equivalent	• 177
		• ETI concrete mixers	• 91
		• ETIWIN control software	• 341

NAME	PAGE	NAME	PAGE
• Expansion test molds	• 61	• Kleine apparatus to determine the carbon dioxide level	• 63
• Expansion test table	• 86	• K-Slump test	• 87
• EXT-502/100 extensometer for diameters up to 100 mm	• 331	• Kumagawa Extractor (Soxhelet) capacity 1 L	• 277
• EXT-502/35 extensometer for diameters up to 35 mm	• 331	• Laboratory core barrel probe	• 47
• Extensometer (deformation transducer)	• 328	• Laboratory mixer	• 280
• Extraction bottle method	• 272	• Laboratory test tube racks	• 364
• Falling ball apparatus	• 59	• Laboratory vibrosieve shaker	• 21
• Fast action digital thermometers	• 361	• Lambe apparatus	• 184
• Fast triaxial test	• 234	• Large capacity electronic scales	• 8
• Fast triaxial test	• 243	• Large capacity jaw crusher	• 38
• Fatigue testing equipment	• 298	• Large CRT-WTENLD Wheel Tracker Machine	• 292
• Filler relative density test	• 27	• Large curing cabinet	• 74
• Filter paper	• 197	• Large-capacity sieve shaker	• 24
• Flakiness and elongation index of road aggregates	• 29	• LCL Plasticimeter	• 88
• Flame photometer	• 52	• LCL Plasticity meter	• 59
• Flexure strength test frame with capacity for 1500 kN	• 137	• LDVT displacement sensors (2 mm)	• 128
• Float tester	• 311	• Le Chatelier Flask	• 66
• Floor tile bending test	• 234	• Le Chatelier water bath	• 60
• Folding/bending cross-head with rollers, for machines with 1000/2000 kN capacity	• 331	• Lightweight, small thermal printer.	• 80
• Folding/bending cross-head with rollers, for machines with 400/600 kN capacity	• 331	• Linear displacement transducers	• 194
• Force transducers	• 194	• Linear variation measurement	• 144
• Four-way pressure regulation panel	• 203	• Load plate, 100 kN capacity	• 265
• Four-way pressure regulation panel with digital pressure gauges	• 206	• Load plate, 200 kN capacity	• 265
• Four-way pressure regulation panel with pressure gauge	• 205	• Load plate, 200 kN capacity	• 266
• FRAAS Apparatus	• 312	• Load plate, 600 kN capacity	• 266
• Freeze-thaw test	• 99	• Long roller compactor	• 300
• Funnel viscosity meter	• 67	• Los Angeles machine	• 31
• Galvanised steel closed retort ring with bosshead.	• 363	• Low percussion energy esclerometers	• 142
• Galvanised steel closed retort ring.	• 363	• Machine for flexural testing of roof tiles, floor tiles and plaster boards	• 136
• Geologist's hammer	• 46	• Machine to determine the accelerated polishing coefficient (A.P.C.)	• 36
• Gilmore Apparatus	• 57	• Magnetic heated stirrer	• 181
• Gravel/cement mould with hinges	• 220	• Magnetic particle weld testing.	• 346
• Grips	• 330	• Magnetic stirring rods	• 360
• Hand-operated direct/residual shear	• 189	• Manual air entrainment meter, capacity 1 l	• 64
• Hand-operated light dynamic penetrometer	• 268	• Manual core-head bits	• 166
• Hanging drying racks, made from PVC wire	• 365	• Manual hydraulic sample extractor	• 169
• Harvard miniature test	• 219	• Manual vibrating table	• 89
• Harvard Mould	• 219	• Manual Vicat needle	• 54
• High temperatures muffle furnaces	• 367	• Manually operated jolting table	• 57
• HM-V rack	• 337	• Manually operated jolting table for mortar.	• 58
• Horizontal extractor	• 48	• Marsh Cone	• 262
• Horizontal mechanical sample extractor	• 169	• Marshall automatic compactor	• 281
• Hot air dryer	• 14	• Marshall manual compacting base	• 281
• Hot extraction device	• 274	• Marshall press accessories	• 284
• Hot extraction method	• 273	• Marshall specimen curing	• 282
• Hot reflux extractors	• 276	• Marshall stability	• 283
• Hubbard - Field method	• 287	• Marshall stability test	• 242
• Humidifying systems	• 97	• Marshall test	• 232
• Hydration container	• 62	• Marshall test software	• 285
• Hydraulic dynamic penetrometer	• 267	• Masonry materials. Determination of dimensions and surface quality.	• 34
• Hydraulic power pack	• 105	• Measurement software	• 342
• Hydrostatic weighing frame	• 8	• Membrane holder	• 197
• Ignition oven	• 278	• Membrane volume meter, capacity 1600 mL	• 248
• Immersion thermostats	• 359	• Membrane volume meter, capacity 3000 mL	• 248
• Impact resistance	• 32	• Membrane volume meter, capacity 6000 mL	• 248
• Indentation tests in cubic or Marshall specimens	• 290	• Metal basket measuring 100 x 100 x 100 mm	• 287
• Indirect tensile device.	• 286	• Metal cutting machine	• 356
• Indirect tensile test	• 234	• Metal fabrics with ceramic fibres	• 363
• Indirect tensile test device	• 127	• Metal presses	• 356
• Indirect tensile test device (Brazilian test)	• 127	• Methylene blue test	• 26
• Indirect tensile test for Marshall specimens	• 242	• Methylene blue test	• 261
• Iron mortar with grey steel pestle	• 365	• Micro-deval machine	• 35
• IT-System Equipment	• 158	• Microlance moisture meter	• 172
• Jaw Crusher	• 38	• Microwave oven	• 14
• Joisel apparatus	• 88	• Mobile beam equipment	• 319
• Kelly ball penetrometer	• 87	• Models	• 253
• Kerosene centrifuge	• 277	• Modified Proctor moulds	• 218

NAME	PAGE	NAME	PAGE
• Mold	• 68	• Polishing machine	• 38
• Molding tank	• 57	• Porous disc	• 196
• Monitor-4 radiation monitor	• 251	• Portable equipment for direct shear test on rocks	• 45
• Motor-driven bending strength scale	• 81	• Portable sample extraction probe	• 318
• Motor-driven CBR press, 50 kN capacity. Version ASTM – 1.27 mm/min.	• 228	• Pressure display panel	• 202
• Motor-driven CBR press, 50 kN capacity. Version BS – 1 mm/ min.	• 228	• Pressure filter	• 273
• Motor-driven dynamic penetrometer, DPM 30-20	• 269	• Pressure gauge	• 105
• Motor-driven jolting table	• 58	• Pressure multiplier block 1/12	• 202
• Motor-driven jolting table for mortar	• 58	• Pressure multiplier block 2/6	• 202
• Motor-driven press with 250 kN capacity and H0206/1 digital display	• 75	• Pressure transducers	• 194
• Motor-driven press with double piston test frame of 300/15 kN capacity for compression and bending strength tests.	• 76	• Principal characteristics of the shear apparatus	• 185
• Motor-driven vibrating table	• 89	• Proctor hammers	• 219
• Motorised bar marker	• 344	• Proctor Penetrometer	• 248
• Motor-powered core-head bit	• 166	• Proctor/CBR automatic compactor	• 221
• Mould	• 140	• Proctor/CBR automatic compactor	• 224
• Mould for determining linear contraction	• 175	• Pump pressure display panel	• 201
• Moulds for specimen preparation	• 92	• Pumps	• 367
• Moulds for specimen preparation	• 93	• Pycnometer method	• 175
• Muffle furnaces capable of 1200 °C	• 366	• Quick connectors	• 200
• Muffle ovens capable of 1000 and 1200 °C	• 367	• Radioactive facility accessories	• 258
• Multispeed press with variable speeds, 50 kN capacity. Varia- ble speed range between 0.1 and 63 mm/min	• 229	• Radiology	• 253
• Multitest machine software	• 244	• Rapid curing tank	• 96
• NDE 360 Equipment	• 153	• Reactivity container	• 30
• NDE 360 IE	• 156	• Rebar detectors	• 151
• NDE 360 PS	• 157	• Rectangular base with supporting legs and stainless steel rod.	• 363
• NDE 360 SASW-G	• 155	• Rectangular digital heating plates	• 13
• NDE 360 SASW-S	• 155	• Rectangular heating plates	• 360
• NDE 360 SE-1, H0484/2 NDE 360 IR-1, H0484/3 NDE 360 SE/IR	• 157	• Reducing plate	• 128
• NDE 360 SIR	• 156	• Reflux extractor, capacity 1000 g	• 276
• NDE 360 US	• 158	• Relative density	• 302
• NDE360 UPV	• 149	• Relative density of the filler	• 302
• Needle vibrator	• 94	• Resonant frequency meter	• 152
• No change indicator	• 198	• Ring Penetrometer	• 248
• No change indicator with pressure sensor	• 198	• Rock esclerometer	• 141
• Non-destructive welded joint test.	• 346	• Rocking sieve shaker	• 21
• Non-destructive welded joint test. Penetrating liquid welding test. Detects cracks by introduction of penetrating liquids	• 347	• Rockwell and Super-Rockwell hardness testing machines	• 351
• Non-porous disc	• 196	• Rockwell, Brinell, Vickers universal hardness testing machine	• 353
• Nuclear Area courses	• 258	• Roller compactor	• 299
• O ring assembly tool	• 197	• Roof tile bending test	• 234
• Oil / water system	• 207	• Rotating compactor	• 301
• One-way vibrating table	• 94	• Rotating viscometer	• 311
• Operations	• 253	• RTFOT - ASTM Oven	• 303
• Optional accessories and spare parts for Universal Machines	• 338	• RTFOT - EN Oven	• 303
• Other software characteristics	• 211	• Rubber membrane	• 196
• Ovens with analogue indicator and control.	• 11	• S0150 Digital triaxial machine with a microprocessor with 50 kN capacity	• 193
• Ovens with electronic - digital control	• 12	• Safety protection	• 128
• Panel stand	• 199	• Safety systems	• 235
• Partitionable chamber for curing concrete specimens	• 98	• Sample cradle, 38.1 mm	• 198
• PAT Test	• 62	• Sample cutter	• 40
• Penetration	• 306	• Sample dividers	• 167
• Penetration (accessories)	• 307	• Sample mixing	• 168
• Penetration plunger device	• 57	• Sampling cutting device (38.1mm)	• 199
• Percentage of coat spread	• 321	• Sampling device	• 52
• Permeability	• 321	• Sampling equipment	• 166
• Pinhole apparatus for scatter test	• 261	• Sampling equipment for cement in sacks	• 52
• Pipette pump filler	• 366	• Sampling spoon with handle	• 52
• Pipette sedimentation method	• 178	• Saybolt Digital Viscometer	• 310
• Piston braking device	• 198	• Saybolt Digital Viscometer, 2 specimens	• 310
• Plaster extensometer	• 63	• Saybolt viscometer for high temperatures	• 311
• Plastic limit equipment	• 174	• Sclerometer for rocks	• 46
• Plastic permeameter	• 260	• Sealing rings	• 196
• Pocket Penetrometer	• 263	• Servo-controlled unit	• 79
• Pocket Penetrometer with dial	• 263	• Servo-hydraulic universal testing machines	• 324
		• Servo-hydraulic universal testing machines (DI-CP/S series rack)	• 329
		• Set of minerals as per the Mohs hardness scale	• 46
		• Set of weights	• 10
		• Shape coefficient	• 29

NAME	PAGE	NAME	PAGE
• Shrinkage measuring device	• 62	• Triaxial six or four-pressure system	• 215
• Sieve brushes	• 20	• Triaxial six or four-pressure system	• 216
• Sieve for wet sieving fine materials	• 20	• Triaxial six-pressure system	• 214
• Sieves made of perforated sheet metal	• 19	• Triaxial two-pressure system	• 212
• Sieves with steel mesh	• 16	• Triple beam mechanical scales	• 9
• Signal converters	• 128	• Triple mold for 40 x 40 x 160 mm specimens	• 72
• Single axis tests with extensometric bands	• 131	• Triple mold for 50x50x50 mm samples	• 72
• Single axis tests with LVDT sensors	• 133	• Triple mold for 70 x 70 x 280 mm specimens	• 73
• Six-way pressure regulation panel	• 203	• Tripod supporting legs and stainless steel rod.	• 363
• Six-way pressure regulation panel with digital pressure gauges	• 206	• Tripod supporting legs and stainless steel rod.	• 363
• Six-way pressure regulation panel with pressure gauges	• 204	• TRRL Pendulum skid resistance tester	• 37
• Slake durability tester	• 39	• U box test	• 85
• Slump flow test	• 84	• Ultrasound bath for sieve cleaning	• 20
• Software	• 297	• Ultrasound equipment	• 41
• Software displays	• 231	• Ultrasound equipment	• 148
• Software for concrete	• 129	• Ultrasound fracture and defect detector. RP 3000	• 345
• Software for Data Control and Acquisition	• 245	• Unaltered terrain sampling equipment	• 166
• Software for direct shear tests	• 187	• Unconfined compression test	• 234
• Software for oedometric tests	• 183	• Universal machine for servo-pneumatic asphalt tests	• 293
• Software Proeti TCSoft2004Plus	• 78	• Universal machine for servo-pneumatic asphalt tests	• 294
• Software PROETI UDI16/4	• 77	• Universal servo-hydraulic systems	• 296
• Soil-cement mould with hinges	• 220	• UU - Non-consolidated, undrained test	• 192
• Soundproof cabin	• 24	• V funnel test	• 85
• Specific weight of aggregates	• 28	• Vacuum pump method recovery equipment	• 290
• Specimen cutting devices	• 101	• Vane test	• 189
• Specimen grinder	• 101	• Vane Test apparatus, ASTM D2573	• 263
• Speed control and regulation CV/PC	• 236	• Vane Test in situ	• 264
• Speedy moisture meter	• 171	• Variable load permeameter	• 259
• Split mould	• 197	• Vebe consistometer	• 86
• Stand for Compression/Bending Test Machines	• 80	• Vialit test equipment	• 289
• Standard Digital Viscometer (TAR, BRTA)	• 309	• Vibrating hammer	• 282
• Standard Digital Viscometer (TAR, BRTA), 2 specimens	• 309	• Vibrating hammer	• 225
• Standard Proctor moulds	• 217	• Vibrating laboratory table	• 94
• Steel plates	• 219	• Vibrating machine for 70.7 mm molds	• 73
• Sulphate stirrer	• 181	• Vicat manual needle for plaster	• 54
• Surface irregularity	• 318	• Volume change transducers	• 194
• Surface moisture in fine aggregate	• 172	• Walz Consistometer	• 86
• Surface moisture of fine aggregate	• 29	• Water bath for curing concrete specimens	• 95
• Surface sampler with cutting ring	• 166	• Water bath for curing mortar specimens	• 74
• System with air / water membrane cell	• 208	• Water bath with thermostatic coil included	• 307
• TAG Viscometer	• 308	• Water displacement method	• 176
• Tar distillation	• 304	• Water level probes	• 269
• Technical specifications:	• 223	• Water retention equipment	• 68
• Teflon magnets, with rotating pivot	• 365	• Wear resistance	• 33
• Temperature and humidity control for concrete specimen curing chambers	• 96	• Wear resistance	• 33
• Temperature control chamber	• 295	• Wheel Tracker machines according to European standards	• 291
• Template for aciculars	• 49	• Wheel Tracker machines according to European standards	• 292
• Test Frame	• 235	• Windsor probe	• 143
• Testing area	• 105	• Wood esclerometer	• 142
• Testing for materials finer than 75 µm	• 26	• Wooden-handled spatulas	• 364
• Texture	• 321	• Yale pycnometer	• 274
• Thermo-cement spectrophotometer system	• 65		
• Thermometers	• 313		
• Thermostat controlled heating and cooling unit	• 57		
• Thermostatic baths	• 359		
• Thick plastic curing tank	• 95		
• Thickness meter	• 321		
• Thin film rotating evaporator	• 274		
• Three part mould	• 198		
• Tools for "in situ" density tests	• 249		
• Top head with drainage	• 196		
• Top head without drainage	• 196		
• Torvane shear tester	• 264		
• Training course	• 251		
• Trapped air meters	• 90		
• Trays	• 16		
• Triaxial cells with five ports	• 195		
• Triaxial four-pressure system	• 213		

NAME	PAGE	NAME	PAGE	NAME	PAGE
• A0001	• 16	• A0515/20	• 24	• A0560	• 27
• A0002	• 16	• A0515/21	• 24	• A0561	• 27
• A0003	• 16	• A0515/22	• 24	• A0561/2	• 27
• A0004	• 16	• A0515/23	• 24	• A0562	• 175
• A0005	• 16	• A0515/24	• 24	• A0562	• 27
• A0006	• 16	• A0515/25	• 24	• A0563	• 27
• A0010	• 16	• A0515/26	• 24	• A0564	• 27
• A0011	• 16	• A0515/27	• 24	• A0565	• 8
• A0012	• 16	• A0515/3	• 24	• A0565	• 27
• A0013	• 16	• A0515/4	• 24	• A0566	• 27
• A0014	• 16	• A0515/5	• 24	• A0568	• 172
• A0015	• 16	• A0515/6	• 24	• A0570	• 28
• A0460	• 20	• A0515/7	• 24	• A0570/1	• 28
• A0461	• 20	• A0515/8	• 24	• A0576	• 28
• A0462	• 20	• A0515/9	• 24	• A0577	• 28
• A0463	• 20	• A0518	• 26	• A0578	• 28
• A0464	• 20	• A0520	• 25	• A0579	• 28
• A0465	• 20	• A0521	• 25	• A0580	• 28
• A0466	• 20	• A0522	• 25	• A0597	• 29
• A0467	• 20	• A0523	• 25	• A0600	• 29
• A0468	• 20	• A0524	• 25	• A0601	• 29
• A0469	• 20	• A0525	• 25	• A0605	• 29
• A0500	• 20	• A0526	• 25	• A0606	• 29
• A0501	• 20	• A0530	• 25	• A0607	• 29
• A0501/1	• 20	• A0530/1	• 49	• A0607/1	• 29
• A0502	• 20	• A0531	• 25	• A0607/2	• 29
• A0502/1	• 20	• A0531/1	• 49	• A0610	• 30
• A0503	• 20	• A0532	• 25	• A0615	• 30
• A0503/1	• 20	• A0532/1	• 49	• A0616	• 30
• A0503/2	• 20	• A0533	• 25	• A0621	• 31
• A0504	• 23	• A0533/1	• 49	• A0622.	• 31
• A0504/1	• 23	• A0534	• 25	• A0623	• 31
• A0504/2	• 23	• A0534/1	• 49	• A0624	• 31
• A0504/3	• 23	• A0535	• 25	• A0624/1	• 31
• A0504/4	• 23	• A0535/1	• 49	• A0624/2	• 31
• A0504/5	• 23	• A0536	• 25	• A0624/3	• 31
• A0504/6	• 23	• A0536/1	• 49	• A0624/4	• 31
• A0504/7	• 23	• A0537	• 25	• A0625	• 31
• A0505	• 21	• A0537/1	• 49	• A0625/1 J	• 31
• A0506	• 21	• A0538	• 25	• A0625/2	• 31
• A0507	• 22	• A0538/1	• 49	• A0625/4	• 31
• A0508	• 22	• A0539	• 25	• A0630	• 32
• A0509	• 21	• A0539/1	• 49	• A0631	• 32
• A0510	• 22	• A0540	• 25	• A0635	• 32
• A0511	• 21	• A0540/1	• 49	• A0635/1	• 32
• A0512	• 24	• A0541	• 25	• A0635/2	• 32
• A0515	• 24	• A0541/1	• 49	• A0636	• 32
• A0515/1	• 24	• A0542	• 25	• A0636/1	• 32
• A0515/10	• 24	• A0542/1	• 49	• A0640	• 32
• A0515/11	• 24	• A0543	• 25	• A0645	• 33
• A0515/12	• 24	• A0543/1	• 49	• A0645/1	• 33
• A0515/13	• 24	• A0545	• 26	• A0650/1	• 33
• A0515/14	• 24	• A0550	• 26	• A0650/2	• 33
• A0515/15	• 24	• A0552	• 261	• A0650/3	• 33
• A0515/17	• 24	• A0552	• 26	• A0651	• 34
• A0515/18	• 24	• A0553	• 261	• A0651/1	• 34
• A0515/19	• 24	• A0553	• 26	• A0651/2	• 34
• A0515/19	• 24	• A0555	• 261	• A0652/1	• 34
• A0515/2	• 24	• A0555	• 26	• A0652/2	• 34

NAME	PAGE	NAME	PAGE	NAME	PAGE
• A0652/2	• 34	• A0691	• 47	• A1105	• 16
• A0653	• 34	• A0691/1	• 47	• A1106	• 16
• A0655	• 35	• A0691/2	• 47	• A1107	• 16
• A0655/1	• 35	• A0691/3	• 47	• A1108	• 16
• A0655/1/2	• 35	• A0691/5	• 48	• A1109	• 16
• A0655/1/3	• 35	• A0692	• 47	• A1110	• 16
• A0655/2	• 35	• A0692/1	• 47	• A1111	• 16
• A0655/3	• 35	• A0692/2	• 47	• A1112	• 16
• A0655/4	• 35	• A0692/3	• 47	• A1113	• 16
• A0655/5	• 35	• A0692/5	• 48	• A1114	• 16
• A0656	• 36	• A0693	• 47	• A1114	• 16
• A0656/2	• 36	• A0693/1	• 47	• A1115	• 16
• A0660	• 36	• A0693/2	• 47	• A1116	• 16
• A0660/1	• 36	• A0693/3	• 47	• A1117	• 16
• A0660/2	• 36	• A0693/5	• 48	• A1118	• 16
• A0660/3	• 36	• A0694	• 47	• A1119	• 17
• A0660/4	• 36	• A0694/1	• 47	• A1120	• 17
• A0660/5	• 36	• A0694/2	• 47	• A1121	• 17
• A0660/6	• 36	• A0694/3	• 47	• A1122	• 17
• A0660/7	• 36	• A0694/5	• 48	• A1123	• 17
• A0661	• 37	• A0705	• 47	• A1124	• 17
• A0661/1	• 37	• A0705/1	• 47	• A1125	• 17
• A0661/2	• 37	• A0705/2	• 47	• A1126	• 17
• A0661/3	• 37	• A0705/3	• 47	• A1127	• 17
• A0661/5	• 37	• A0705/4	• 47	• A1128	• 17
• A0661/6	• 37	• A0706	• 48	• A1129	• 17
• A0668	• 38	• A0706/1	• 48	• A1130	• 17
• A0668/1	• 38	• A0706/2	• 48	• A1131	• 17
• A0668/2	• 38	• A0706/3	• 48	• A1132	• 17
• A0668/3	• 38	• A0706/4	• 48	• A1133	• 17
• A0668/4	• 38	• A0707	• 48	• A1134	• 17
• A0670	• 38	• A0707/1	• 48	• A1135	• 17
• A0670/1	• 38	• A0708	• 48	• A1136	• 17
• A0670CE	• 38	• A0710	• 48	• A1137	• 17
• A0671	• 39	• A0710/1	• 48	• A1138	• 17
• A0671/4	• 39	• A0715	• 46	• A1139	• 17
• A0671/6	• 39	• A0715/1	• 46	• A1140	• 17
• A0671/7	• 39	• A0718	• 46	• A1141	• 17
• A0671/8	• 39	• A0718/1	• 46	• A1142	• 17
• A0671/9	• 39	• A0722	• 38	• A1143	• 17
• A0675	• 39	• A0732	• 49	• A1144	• 17
• A0675/1	• 39	• A0732	• 49	• A1145	• 17
• A0678	• 40	• A0735	• 49	• A1146	• 17
• A0679	• 40	• A0736	• 49	• A1147	• 177
• A0680	• 40	• A0737	• 49	• A1147	• 17
• A0680/1	• 40	• A0738	• 49	• A1148	• 17
• A0680/2	• 40	• A0742	• 49	• A1149	• 17
• A0680/3	• 40	• A0743	• 49	• A1150	• 17
• A0680/4	• 40	• A0744	• 49	• A1151	• 17
• A0680/5	• 40	• A0745	• 49	• A1152	• 17
• A0680/6	• 40	• A0746	• 49	• A1153	• 17
• A0681	• 45	• A0747	• 49	• A1154	• 17
• A0682	• 45	• A0750	• 41	• A1155	• 17
• A0683	• 45	• A0766	• 49	• A1156	• 17
• A0685	• 45	• A1100	• 16	• A1157	• 17
• A0685/1	• 45	• A1101	• 16	• A1158	• 17
• A0685/2	• 45	• A1102	• 16	• A1159	• 17
• A0685/3	• 45	• A1103	• 16	• A1160	• 17
• A0685/4	• 45	• A1104	• 16	• A1161	• 17

NAME	PAGE	NAME	PAGE	NAME	PAGE
• A1162	• 17	• A1221	• 17	• A1280	• 18
• A1163	• 17	• A1222	• 17	• A1281	• 18
• A1164	• 18	• A1223	• 17	• A1282	• 18
• A1165	• 18	• A1224	• 17	• A1284	• 18
• A1166	• 18	• A1225	• 17	• A1285	• 18
• A1167	• 18	• A1226	• 17	• A1286	• 18
• A1168	• 18	• A1227	• 17	• A1287	• 18
• A1169	• 18	• A1228	• 17	• A1288	• 18
• A1170	• 18	• A1229	• 17	• A1289	• 18
• A1171	• 18	• A1230	• 17	• A1290	• 18
• A1172	• 18	• A1231	• 17	• A1291	• 18
• A1173	• 18	• A1232	• 17	• A1292	• 18
• A1174	• 18	• A1233	• 17	• A1293	• 18
• A1175	• 18	• A1234	• 17	• A1294	• 18
• A1176	• 18	• A1235	• 17	• A1295	• 18
• A1177	• 18	• A1236	• 17	• A1296	• 18
• A1178	• 18	• A1237	• 17	• A1298	• 18
• A1179	• 18	• A1238	• 17	• A1299	• 18
• A1180	• 18	• A1239	• 17	• A1300	• 16
• A1181	• 18	• A1240	• 17	• A1301	• 16
• A1182	• 18	• A1241	• 17	• A1302	• 16
• A1183	• 18	• A1242	• 17	• A1303	• 16
• A1184	• 18	• A1243	• 17	• A1304	• 16
• A1185	• 18	• A1244	• 17	• A1305	• 16
• A1186	• 18	• A1245	• 17	• A1306	• 16
• A1187	• 18	• A1246	• 17	• A1307	• 16
• A1188	• 18	• A1247	• 17	• A1308	• 16
• A1189	• 18	• A1248	• 17	• A1309	• 16
• A1190	• 18	• A1249	• 17	• A1310	• 16
• A1191	• 18	• A1250	• 17	• A1311	• 16
• A1192	• 18	• A1251	• 17	• A1312	• 16
• A1193	• 18	• A1252	• 17	• A1313	• 16
• A1194	• 18	• A1253	• 17	• A1314	• 16
• A1195	• 18	• A1254	• 17	• A1315	• 16
• A1196	• 18	• A1255	• 17	• A1316	• 16
• A1198	• 18	• A1256	• 17	• A1317	• 16
• A1199	• 18	• A1257	• 17	• A1318	• 16
• A1200	• 16	• A1258	• 17	• A1319	• 17
• A1201	• 16	• A1259	• 17	• A1320	• 17
• A1202	• 16	• A1260	• 17	• A1321	• 17
• A1203	• 16	• A1261	• 17	• A1322	• 17
• A1204	• 16	• A1262	• 17	• A1323	• 17
• A1205	• 16	• A1263	• 17	• A1324	• 17
• A1206	• 16	• A1264	• 18	• A1325	• 17
• A1207	• 16	• A1265	• 18	• A1326	• 17
• A1208	• 16	• A1266	• 18	• A1327	• 17
• A1209	• 16	• A1267	• 18	• A1328	• 17
• A1210	• 16	• A1268	• 18	• A1329	• 17
• A1211	• 16	• A1269	• 18	• A1330	• 17
• A1212	• 16	• A1270	• 18	• A1331	• 17
• A1213	• 16	• A1271	• 18	• A1332	• 17
• A1214	• 16	• A1272	• 18	• A1333	• 17
• A1215	• 16	• A1273	• 18	• A1334	• 17
• A1215	• 16	• A1274	• 18	• A1335	• 17
• A1216	• 16	• A1275	• 18	• A1336	• 17
• A1217	• 16	• A1276	• 18	• A1337	• 17
• A1218	• 16	• A1277	• 18	• A1338	• 17
• A1219	• 17	• A1278	• 18	• A1339	• 17
• A1220	• 17	• A1279	• 18	• A1340	• 17



NAME	PAGE	NAME	PAGE	NAME	PAGE
• A1341	• 17	• A1402	• 16	• A1462	• 17
• A1342	• 17	• A1403	• 16	• A1463	• 17
• A1343	• 17	• A1404	• 16	• A1464	• 18
• A1344	• 17	• A1405	• 16	• A1465	• 18
• A1345	• 17	• A1406	• 16	• A1466	• 18
• A1346	• 17	• A1407	• 16	• A1467	• 18
• A1347	• 17	• A1408	• 16	• A1468	• 18
• A1348	• 17	• A1409	• 16	• A1469	• 18
• A1349	• 17	• A1410	• 16	• A1470	• 18
• A1350	• 17	• A1411	• 16	• A1471	• 18
• A1351	• 17	• A1412	• 16	• A1472	• 18
• A1352	• 17	• A1413	• 16	• A1473	• 18
• A1353	• 17	• A1415	• 16	• A1474	• 18
• A1354	• 17	• A1416	• 16	• A1475	• 18
• A1355	• 17	• A1417	• 16	• A1476	• 18
• A1356	• 17	• A1418	• 16	• A1477	• 18
• A1357	• 17	• A1419	• 17	• A1478	• 18
• A1358	• 17	• A1420	• 17	• A1479	• 18
• A1359	• 17	• A1421	• 17	• A1480	• 18
• A1360	• 17	• A1422	• 17	• A1481	• 18
• A1361	• 17	• A1423	• 17	• A1482	• 18
• A1362	• 17	• A1424	• 17	• A1483	• 18
• A1363	• 17	• A1425	• 17	• A1484	• 18
• A1364	• 18	• A1426	• 17	• A1485	• 18
• A1365	• 18	• A1427	• 17	• A1486	• 18
• A1366	• 18	• A1428	• 17	• A1487	• 18
• A1367	• 18	• A1429	• 17	• A1488	• 18
• A1368	• 18	• A1430	• 17	• A1489	• 18
• A1369	• 18	• A1431	• 17	• A1490	• 18
• A1370	• 18	• A1432	• 17	• A1491	• 18
• A1371	• 18	• A1433	• 17	• A1492	• 18
• A1372	• 18	• A1434	• 17	• A1493	• 18
• A1373	• 18	• A1435	• 17	• A1494	• 18
• A1374	• 18	• A1436	• 17	• A1495	• 18
• A1375	• 18	• A1437	• 17	• A1496	• 18
• A1376	• 18	• A1438	• 17	• A1498	• 18
• A1377	• 18	• A1439	• 17	• A1499	• 18
• A1378	• 18	• A1440	• 17	• A1500	• 16
• A1379	• 18	• A1441	• 17	• A1501	• 16
• A1380	• 18	• A1442	• 17	• A1502	• 16
• A1381	• 18	• A1443	• 17	• A1503	• 16
• A1382	• 18	• A1444	• 17	• A1504	• 16
• A1383	• 18	• A1445	• 17	• A1505	• 16
• A1384	• 18	• A1446	• 17	• A1506	• 16
• A1385	• 18	• A1447	• 17	• A1507	• 16
• A1386	• 18	• A1448	• 17	• A1508	• 16
• A1388	• 18	• A1449	• 17	• A1509	• 16
• A1389	• 18	• A1450	• 17	• A1510	• 16
• A1390	• 18	• A1451	• 17	• A1511	• 16
• A1391	• 18	• A1452	• 17	• A1512	• 16
• A1392	• 18	• A1453	• 17	• A1513	• 16
• A1393	• 18	• A1454	• 17	• A1514	• 16
• A1394	• 18	• A1455	• 17	• A1516	• 16
• A1395	• 18	• A1456	• 17	• A1517	• 16
• A1396	• 18	• A1457	• 17	• A1518	• 16
• A1398	• 18	• A1458	• 17	• A1519	• 17
• A1399	• 18	• A1459	• 17	• A1520	• 17
• A1400	• 16	• A1460	• 17	• A1521	• 17
• A1401	• 16	• A1461	• 17	• A1522	• 17

NAME	PAGE	NAME	PAGE	NAME	PAGE
• A1523	• 17	• A1582	• 18	• A1642	• 17
• A1524	• 17	• A1583	• 18	• A1643	• 17
• A1525	• 17	• A1584	• 18	• A1644	• 17
• A1526	• 17	• A1585	• 18	• A1645	• 17
• A1527	• 17	• A1586	• 18	• A1646	• 17
• A1528	• 17	• A1587	• 18	• A1647	• 17
• A1529	• 17	• A1588	• 18	• A1648	• 17
• A1530	• 17	• A1589	• 18	• A1649	• 17
• A1531	• 17	• A1590	• 18	• A1650	• 17
• A1532	• 17	• A1591	• 18	• A1651	• 17
• A1533	• 17	• A1592	• 18	• A1652	• 17
• A1534	• 17	• A1593	• 18	• A1653	• 17
• A1535	• 17	• A1594	• 18	• A1654	• 17
• A1536	• 17	• A1595	• 18	• A1655	• 17
• A1537	• 17	• A1596	• 18	• A1656	• 17
• A1538	• 17	• A1598	• 18	• A1657	• 17
• A1539	• 17	• A1599	• 18	• A1658	• 17
• A1540	• 17	• A1600	• 16	• A1659	• 17
• A1541	• 17	• A1601	• 16	• A1660	• 17
• A1542	• 17	• A1602	• 16	• A1661	• 17
• A1543	• 17	• A1603	• 16	• A1662	• 17
• A1544	• 17	• A1604	• 16	• A1663	• 17
• A1545	• 17	• A1605	• 16	• A1664	• 18
• A1546	• 17	• A1606	• 16	• A1665	• 18
• A1547	• 17	• A1607	• 16	• A1666	• 18
• A1548	• 17	• A1608	• 16	• A1667	• 18
• A1549	• 17	• A1609	• 16	• A1668	• 18
• A1550	• 17	• A1610	• 16	• A1669	• 18
• A1551	• 17	• A1611	• 16	• A1670	• 18
• A1552	• 17	• A1612	• 16	• A1671	• 18
• A1553	• 17	• A1613	• 16	• A1672	• 18
• A1554	• 17	• A1614	• 16	• A1673	• 18
• A1555	• 17	• A1615	• 16	• A1674	• 18
• A1556	• 17	• A1616	• 16	• A1675	• 18
• A1557	• 17	• A1617	• 16	• A1676	• 18
• A1558	• 17	• A1618	• 16	• A1677	• 18
• A1559	• 17	• A1619	• 17	• A1678	• 18
• A1560	• 17	• A1620	• 17	• A1679	• 18
• A1561	• 17	• A1621	• 17	• A1680	• 18
• A1562	• 17	• A1622	• 17	• A1681	• 18
• A1563	• 17	• A1623	• 17	• A1682	• 18
• A1564	• 18	• A1624	• 17	• A1683	• 18
• A1565	• 18	• A1625	• 17	• A1684	• 18
• A1566	• 18	• A1626	• 17	• A1685	• 18
• A1567	• 18	• A1627	• 17	• A1686	• 18
• A1568	• 18	• A1628	• 17	• A1687	• 18
• A1569	• 18	• A1629	• 17	• A1688	• 18
• A1570	• 18	• A1630	• 17	• A1689	• 18
• A1571	• 18	• A1631	• 17	• A1690	• 18
• A1572	• 18	• A1632	• 17	• A1691	• 18
• A1573	• 18	• A1633	• 17	• A1692	• 18
• A1574	• 18	• A1634	• 17	• A1693	• 18
• A1575	• 18	• A1635	• 17	• A1694	• 18
• A1576	• 18	• A1636	• 17	• A1695	• 18
• A1577	• 18	• A1637	• 17	• A1696	• 18
• A1578	• 18	• A1638	• 17	• A1698	• 18
• A1579	• 18	• A1639	• 17	• A1699	• 18
• A1580	• 18	• A1640	• 17	• A1700	• 16
• A1581	• 18	• A1641	• 17	• A1701	• 16



NAME	PAGE	NAME	PAGE	NAME	PAGE
• A1702	• 16	• A1761	• 17	• A1821	• 17
• A1703	• 16	• A1762	• 17	• A1822	• 17
• A1704	• 16	• A1763	• 17	• A1823	• 17
• A1705	• 16	• A1764	• 18	• A1824	• 17
• A1706	• 16	• A1765	• 18	• A1825	• 17
• A1707	• 16	• A1766	• 18	• A1826	• 17
• A1708	• 16	• A1767	• 18	• A1827	• 17
• A1709	• 16	• A1768	• 18	• A1828	• 17
• A1710	• 16	• A1769	• 18	• A1829	• 17
• A1711	• 16	• A1770	• 18	• A1830	• 17
• A1712	• 16	• A1771	• 18	• A1831	• 17
• A1713	• 16	• A1772	• 18	• A1832	• 17
• A1714	• 16	• A1773	• 18	• A1833	• 17
• A1715	• 16	• A1774	• 18	• A1834	• 17
• A1716	• 16	• A1775	• 18	• A1835	• 17
• A1717	• 16	• A1776	• 18	• A1836	• 17
• A1718	• 16	• A1777	• 18	• A1837	• 17
• A1719	• 17	• A1778	• 18	• A1838	• 17
• A1720	• 17	• A1779	• 18	• A1839	• 17
• A1721	• 17	• A1780	• 18	• A1840	• 17
• A1722	• 17	• A1781	• 18	• A1841	• 17
• A1723	• 17	• A1782	• 18	• A1842	• 17
• A1724	• 17	• A1783	• 18	• A1843	• 17
• A1725	• 17	• A1784	• 18	• A1844	• 17
• A1726	• 17	• A1785	• 18	• A1845	• 17
• A1727	• 17	• A1786	• 18	• A1846	• 17
• A1728	• 17	• A1787	• 18	• A1847	• 17
• A1729	• 17	• A1788	• 18	• A1848	• 17
• A1730	• 17	• A1789	• 18	• A1849	• 17
• A1731	• 17	• A1790	• 18	• A1850	• 17
• A1732	• 17	• A1791	• 18	• A1851	• 17
• A1733	• 17	• A1792	• 18	• A1852	• 17
• A1734	• 17	• A1793	• 18	• A1853	• 17
• A1735	• 17	• A1794	• 18	• A1854	• 17
• A1736	• 17	• A1795	• 18	• A1855	• 17
• A1737	• 17	• A1796	• 18	• A1856	• 17
• A1738	• 17	• A1798	• 18	• A1857	• 17
• A1739	• 17	• A1799	• 18	• A1858	• 17
• A1740	• 17	• A1800	• 16	• A1859	• 17
• A1741	• 17	• A1801	• 16	• A1860	• 17
• A1742	• 17	• A1802	• 16	• A1861	• 17
• A1743	• 17	• A1803	• 16	• A1862	• 17
• A1744	• 17	• A1804	• 16	• A1863	• 17
• A1745	• 17	• A1805	• 16	• A1864	• 18
• A1746	• 17	• A1806	• 16	• A1865	• 18
• A1747	• 17	• A1807	• 16	• A1866	• 18
• A1748	• 17	• A1808	• 16	• A1867	• 18
• A1749	• 17	• A1809	• 16	• A1868	• 18
• A1750	• 17	• A1810	• 16	• A1869	• 18
• A1751	• 17	• A1811	• 16	• A1870	• 18
• A1752	• 17	• A1812	• 16	• A1871	• 18
• A1753	• 17	• A1813	• 16	• A1872	• 18
• A1754	• 17	• A1814	• 16	• A1873	• 18
• A1755	• 17	• A1815	• 16	• A1874	• 18
• A1756	• 17	• A1816	• 16	• A1875	• 18
• A1757	• 17	• A1817	• 16	• A1876	• 18
• A1758	• 17	• A1818	• 16	• A1877	• 18
• A1759	• 17	• A1819	• 17	• A1878	• 18
• A1760	• 17	• A1820	• 17	• A1879	• 18

NAME	PAGE	NAME	PAGE	Z	PAGE
• A1880	• 18	• A2040	• 19	• A2215	• 19
• A1881	• 18	• A2040	• 19	• A2216	• 19
• A1882	• 18	• A2100	• 19	• A2217	• 19
• A1883	• 18	• A2101	• 19	• A2218	• 19
• A1884	• 18	• A2102	• 19	• A2219	• 19
• A1885	• 18	• A2103	• 19	• A2220	• 19
• A1886	• 18	• A2104	• 19	• A2221	• 19
• A1887	• 18	• A2105	• 19	• A2222	• 19
• A1888	• 18	• A2106	• 19	• A2223	• 19
• A1889	• 18	• A2107	• 19	• A2224	• 19
• A1890	• 18	• A2108	• 19	• A2225	• 19
• A1891	• 18	• A2109	• 19	• A2226	• 19
• A1892	• 18	• A2110	• 19	• A2227	• 19
• A1893	• 18	• A2111	• 19	• A2228	• 19
• A1894	• 18	• A2112	• 19	• A2229	• 19
• A1895	• 18	• A2113	• 19	• A2230	• 19
• A1896	• 18	• A2114	• 19	• A2231	• 19
• A1898	• 18	• A2115	• 19	• A2232	• 19
• A1899	• 18	• A2116	• 19	• A2233	• 19
• A2000	• 19	• A2117	• 19	• A2234	• 19
• A2001	• 19	• A2118	• 19	• A2235	• 19
• A2002	• 19	• A2119	• 19	• A2236	• 19
• A2003	• 19	• A2120	• 19	• A2237	• 19
• A2004	• 19	• A2121	• 19	• A2238	• 19
• A2005	• 19	• A2122	• 19	• A2239	• 19
• A2006	• 19	• A2123	• 19	• A2240	• 19
• A2007	• 19	• A2124	• 19	• A2240	• 19
• A2008	• 19	• A2125	• 19	• A2300	• 19
• A2009	• 19	• A2126	• 19	• A2301	• 19
• A2010	• 19	• A2127	• 19	• A2302	• 19
• A2011	• 19	• A2128	• 19	• A2303	• 19
• A2012	• 19	• A2129	• 19	• A2304	• 19
• A2013	• 19	• A2130	• 19	• A2305	• 19
• A2014	• 19	• A2131	• 19	• A2306	• 19
• A2015	• 19	• A2132	• 19	• A2307	• 19
• A2016	• 19	• A2133	• 19	• A2308	• 19
• A2017	• 19	• A2134	• 19	• A2309	• 19
• A2018	• 19	• A2135	• 19	• A2310	• 19
• A2019	• 19	• A2136	• 19	• A2311	• 19
• A2020	• 19	• A2137	• 19	• A2312	• 19
• A2021	• 19	• A2138	• 19	• A2313	• 19
• A2022	• 19	• A2139	• 19	• A2314	• 19
• A2023	• 19	• A2140	• 19	• A2315	• 19
• A2024	• 19	• A2140	• 19	• A2316	• 19
• A2025	• 19	• A2200	• 19	• A2317	• 19
• A2026	• 19	• A2201	• 19	• A2318	• 19
• A2027	• 19	• A2202	• 19	• A2319	• 19
• A2028	• 19	• A2203	• 19	• A2320	• 19
• A2029	• 19	• A2204	• 19	• A2321	• 19
• A2030	• 19	• A2205	• 19	• A2322	• 19
• A2031	• 19	• A2206	• 19	• A2323	• 19
• A2032	• 19	• A2207	• 19	• A2324	• 19
• A2033	• 19	• A2208	• 19	• A2325	• 19
• A2034	• 19	• A2209	• 19	• A2326	• 19
• A2035	• 19	• A2210	• 19	• A2327	• 19
• A2036	• 19	• A2211	• 19	• A2328	• 19
• A2037	• 19	• A2212	• 19	• A2329	• 19
• A2038	• 19	• A2213	• 19	• A2330	• 19
• A2039	• 19	• A2214	• 19	• A2331	• 19

NAME	PAGE	NAME	PAGE	NAME	PAGE
• A2332	• 19	• A2507	• 19	• A2624	• 19
• A2333	• 19	• A2508	• 19	• A2625	• 19
• A2334	• 19	• A2509	• 19	• A2626	• 19
• A2335	• 19	• A2510	• 19	• A2627	• 19
• A2336	• 19	• A2511	• 19	• A2628	• 19
• A2337	• 19	• A2512	• 19	• A2629	• 19
• A2338	• 19	• A2513	• 19	• A2630	• 19
• A2339	• 19	• A2514	• 19	• A2631	• 19
• A2340	• 19	• A2515	• 19	• A2632	• 19
• A2340	• 19	• A2516	• 19	• A2633	• 19
• A2400	• 19	• A2517	• 19	• A2634	• 19
• A2401	• 19	• A2518	• 19	• A2635	• 19
• A2402	• 19	• A2519	• 19	• A2636	• 19
• A2403	• 19	• A2520	• 19	• A2637	• 19
• A2404	• 19	• A2521	• 19	• A2638	• 19
• A2405	• 19	• A2522	• 19	• A2639	• 19
• A2406	• 19	• A2523	• 19	• A2640	• 19
• A2407	• 19	• A2524	• 19	• A2640	• 19
• A2408	• 19	• A2525	• 19	• A2700	• 19
• A2409	• 19	• A2526	• 19	• A2701	• 19
• A2410	• 19	• A2527	• 19	• A2702	• 19
• A2411	• 19	• A2528	• 19	• A2703	• 19
• A2412	• 19	• A2529	• 19	• A2704	• 19
• A2413	• 19	• A2530	• 19	• A2705	• 19
• A2414	• 19	• A2531	• 19	• A2706	• 19
• A2415	• 19	• A2532	• 19	• A2707	• 19
• A2416	• 19	• A2533	• 19	• A2708	• 19
• A2417	• 19	• A2534	• 19	• A2709	• 19
• A2418	• 19	• A2535	• 19	• A2710	• 19
• A2419	• 19	• A2536	• 19	• A2711	• 19
• A2420	• 19	• A2537	• 19	• A2712	• 19
• A2421	• 19	• A2538	• 19	• A2713	• 19
• A2422	• 19	• A2539	• 19	• A2714	• 19
• A2423	• 19	• A2540	• 19	• A2715	• 19
• A2424	• 19	• A2540	• 19	• A2716	• 19
• A2425	• 19	• A2600	• 19	• A2717	• 19
• A2426	• 19	• A2601	• 19	• A2718	• 19
• A2427	• 19	• A2602	• 19	• A2719	• 19
• A2428	• 19	• A2603	• 19	• A2720	• 19
• A2429	• 19	• A2604	• 19	• A2721	• 19
• A2430	• 19	• A2605	• 19	• A2722	• 19
• A2431	• 19	• A2606	• 19	• A2723	• 19
• A2432	• 19	• A2607	• 19	• A2724	• 19
• A2433	• 19	• A2608	• 19	• A2725	• 19
• A2434	• 19	• A2609	• 19	• A2726	• 19
• A2435	• 19	• A2610	• 19	• A2727	• 19
• A2436	• 19	• A2611	• 19	• A2728	• 19
• A2437	• 19	• A2612	• 19	• A2729	• 19
• A2438	• 19	• A2613	• 19	• A2730	• 19
• A2439	• 19	• A2614	• 19	• A2731	• 19
• A2440	• 19	• A2615	• 19	• A2732	• 19
• A2440	• 19	• A2616	• 19	• A2733	• 19
• A2500	• 19	• A2617	• 19	• A2734	• 19
• A2501	• 19	• A2618	• 19	• A2735	• 19
• A2502	• 19	• A2619	• 19	• A2736	• 19
• A2503	• 19	• A2620	• 19	• A2737	• 19
• A2504	• 19	• A2621	• 19	• A2738	• 19
• A2505	• 19	• A2622	• 19	• A2739	• 19
• A2506	• 19	• A2623	• 19	• A2740	• 19

NAME	PAGE	NAME	PAGE	NAME	PAGE
• A2740	• 19	• B0037	• 282	• B0100/1	• 289
• A3187	• 18	• B0038	• 280	• B0100/2	• 289
• B0001	• 272	• B0038/1	• 280	• B0100/3	• 289
• B0001/1	• 272	• B0038/2	• 280	• B0105	• 289
• B0001/2	• 272	• B0038/3	• 280	• B0107	• 290
• B0003	• 272	• B0040	• 281	• B0110	• 292
• B0004	• 272	• B0040/1	• 281	• B0110	• 292
• B0007	• 273	• B0041	• 281	• B0110	• 292
• B0007/1	• 273	• B0041/1	• 281	• B0111	• 292
• B0007/2	• 273	• B0041/2	• 281	• B0111	• 292
• B0010	• 273	• B0043	• 281	• B0111	• 292
• B0010/1	• 273	• B0044	• 281	• B0112	• 292
• B0010/1	• 274	• B0045	• 281	• B0115	• 293
• B0010/1	• 276	• B0046	• 281	• B0116	• 296
• B0010/1	• 276	• B0048	• 286	• B0118	• 298
• B0010/2	• 273	• B0050	• 282	• B0120	• 299
• B0010/3	• 273	• B0051	• 282	• B0120/1	• 299
• B0011	• 274	• B0052	• 287	• B0120/2	• 299
• B0011/1	• 274	• B0055	• 283	• B0120/3	• 299
• B0013	• 274	• B0055	• 286	• B0120/4	• 299
• B0013/1	• 274	• B0056	• 283	• B0120/5	• 299
• B0014	• 274	• B0056	• 229	• B0120/6	• 299
• B0015	• 274	• B0056	• 242	• B0121	• 300
• B0020	• 275	• B0057	• 283	• B0121/1	• 300
• B0020/1	• 275	• B0058	• 229	• B0121/2	• 300
• B0020/2	• 275	• B0058	• 242	• B0121/3	• 300
• B0020/5	• 275	• B0059	• 287	• B0121/4	• 300
• B0021	• 275	• B0059/1	• 290	• B0121/5	• 300
• B0021/1	• 275	• B0059/2	• 290	• B0122/1	• 301
• B0021/2	• 275	• B0059/3	• 290	• B0122/10	• 301
• B0022	• 275	• B0059/4	• 290	• B0122/11	• 301
• B0023	• 275	• B0063	• 290	• B0122/2	• 301
• B0024	• 276	• B0064	• 290	• B0122/3	• 301
• B0024/1	• 276	• B0065	• 287	• B0122/4	• 301
• B0024/2	• 276	• B0066	• 287	• B0122/5	• 301
• B0024/3	• 276	• B0067	• 287	• B0122/6	• 301
• B0025	• 276	• B0068	• 287	• B0122/7	• 301
• B0025/1	• 276	• B0069	• 287	• B0122/8	• 301
• B0026	• 276	• B0070	• 287	• B0122/9	• 301
• B0027	• 276	• B0070/1	• 287	• B0125	• 295
• B0028	• 277	• B0070/2	• 287	• B0130	• 302
• B0028/1	• 277	• B0071	• 287	• B0135	• 302
• B0029	• 277	• B0075	• 288	• B0138	• 302
• B0029/1	• 277	• B0076	• 288	• B0139	• 302
• B0030	• 277	• B0077	• 288	• B0150	• 302
• B0031	• 278	• B0078	• 288	• B0150/1	• 302
• B0031/1	• 278	• B0079	• 288	• B0150/3	• 302
• B0031/2	• 278	• B0080	• 288	• B0151	• 303
• B0031/3	• 278	• B0085	• 288	• B0151/1	• 303
• B0031/4	• 278	• B0086	• 288	• B0152	• 303
• B0032	• 279	• B0087	• 288	• B0155	• 304
• B0032/1	• 279	• B0088	• 288	• B0155/1	• 304
• B0032/2	• 279	• B0090	• 288	• B0155/2	• 304
• B0032/3	• 279	• B0091	• 288	• B0155/2	• 304
• B0032/4	• 279	• B0092	• 288	• B0155/3	• 304
• B0032/5	• 279	• B0093	• 288	• B0155/4	• 304
• B0032/6	• 279	• B0097	• 289	• B0155/5	• 304
• B0032/7	• 279	• B0097/1	• 289	• B0155/5	• 304
• B0035	• 280	• B0097/2	• 289	• B0155/5	• 304

NAME	PAGE	NAME	PAGE	NAME	PAGE
• B0155/6	• 304	• C0015/4	• 54	• C0040	• 61
• B0157	• 304	• C0015/5.	• 54	• C0040/1	• 61
• B0157/1	• 304	• C0015/6	• 54	• C0040/1	• 61
• B0157/2	• 304	• C0015/6	• 56	• C0040/1	• 61
• B0157/3	• 304	• C0015/7	• 54	• C0041	• 61
• B0157/4	• 304	• C0015/7	• 56	• C0042	• 61
• B0157/5	• 304	• C0015/8	• 54	• C0043	• 61
• B0159	• 304	• C0015/9	• 54	• C0044	• 61
• B0159/1	• 304	• C0015/9	• 56	• C0045	• 63
• B0159/1	• 304	• C0015/Y	• 54	• C0045/1	• 63
• B0159/2	• 304	• C0015/Y/1	• 54	• C0045/2	• 63
• B0159/3	• 304	• C0015Y//2	• 54	• C0045/3	• 63
• B0160	• 305	• C0016	• 55	• C0045/4	• 63
• B0160/1	• 305	• C0016/1	• 56	• C0045/5	• 63
• B0160/2	• 305	• C0016/10.	• 56	• C0050	• 64
• B0160/3	• 305	• C0016/11	• 56	• C0050/2	• 64
• B0160/4	• 305	• C0016/12	• 56	• C0051	• 64
• B0160/5	• 305	• C0016/13.	• 56	• C0056	• 64
• B0160/6	• 305	• C0016/14	• 56	• C0057	• 64
• B0161	• 305	• C0016/15	• 56	• C0058	• 62
• B0162	• 306	• C0016/16	• 56	• C0059	• 63
• B0165	• 174	• C0016/17	• 57	• C0060	• 64
• B0165	• 306	• C0016/18	• 57	• C0061	• 64
• B0166	• 174	• C0016/2	• 56	• C0062	• 62
• B0166/2	• 174	• C0016/3	• 56	• C0063	• 66
• B0166/5	• 174	• C0016/4	• 56	• C0064	• 66
• B0166/5	• 174	• C0016/5	• 56	• C0065	• 66
• B0166/5	• 302	• C0016/6.	• 56	• C0067	• 67
• B0211	• 361	• C0016/7	• 56	• C0067/1	• 67
• C0001	• 52	• C0017	• 57	• C0068	• 67
• C0002	• 52	• C0018	• 57	• C0068/1	• 67
• C0003	• 52	• C0019	• 57	• C0068/2	• 67
• C0005	• 52	• C0019/1	• 58	• C0070	• 68
• C0005/1	• 52	• C0019/2	• 58	• C0071	• 68
• C0005/2	• 52	• C0019/3	• 58	• C0072	• 68
• C0005/3	• 52	• C0020	• 58	• C0073	• 68
• C0005/4	• 52	• C0021	• 58	• C0075	• 68
• C0005/5	• 52	• C0021/1	• 58	• C0085	• 69
• C0010	• 53	• C0021/2	• 58	• C0085/1	• 70
• C0010/1	• 53	• C0022	• 58	• C0085/2	• 70
• C0010/2	• 53	• C0023	• 59	• C0085/3	• 70
• C0010/3	• 53	• C0023/1	• 59	• C0085/4	• 70
• C0010/4	• 53	• C0023/2	• 59	• C0085/5	• 70
• C0010/5	• 53	• C0024	• 59	• C0086	• 70
• C0010/6	• 53	• C0030	• 60	• C0087	• 71
• C0010/7	• 53	• C0031	• 60	• C0087/1	• 71
• C0010/8	• 53	• C0032	• 60	• C0087/2	• 71
• C0012	• 53	• C0033	• 60	• C0087/3	• 71
• C0012/1	• 53	• C0033/1	• 60	• C0087/4	• 71
• C0012/2	• 53	• C0034	• 60	• C0089	• 72
• C0013	• 53	• C0035	• 61	• C0089/1	• 72
• C0015	• 54	• C0037	• 62	• C0090	• 72
• C0015/1	• 54	• C0037	• 29	• C0090	• 73
• C0015/10	• 54	• C0037/1	• 62	• C0091	• 72
• C0015/10	• 56	• C0037/2	• 62	• C0091	• 73
• C0015/11	• 54	• C0037/3	• 62	• C0092	• 72
• C0015/12	• 54	• C0037/4	• 62	• C0092	• 73
• C0015/2	• 54	• C0038	• 62	• C0092/1	• 72
• C0015/3	• 54	• C0039	• 63	• C0095	• 72

NAME	PAGE	NAME	PAGE	NAME	PAGE
• C0096	• 73	• E0018/5	• 338	• E0068	• 338
• C0097	• 73	• E0019	• 338	• E0068	• 338
• C0098	• 73	• E0019/1	• 338	• E0068	• 345
• C0100	• 73	• E0019/2	• 338	• E0068/1	• 345
• C0105	• 74	• E0019/3	• 338	• E0068/2	• 345
• C0105/1	• 74	• E0019/4	• 338	• E0068/3	• 345
• C0105/1	• 74	• E0019/5	• 338	• E0068/4	• 345
• C0105/3	• 74	• E0019/6	• 339	• E0068/5	• 345
• C0106	• 74	• E0020	• 339	• E0068/6	• 345
• C0110	• 75	• E0020/1	• 339	• E0068/7	• 345
• C0115	• 243	• E0020/2	• 339	• E0068/8	• 345
• C0115	• 243	• E0020/3	• 339	• E0068D	• 346
• C0115	• 79	• E0020/4	• 339	• E0070	• 349
• C0115/3	• 80	• E0020/5	• 339	• E0071	• 349
• C0116	• 243	• E0020/6	• 339	• E0071/1	• 349
• C0116	• 243	• E0022	• 328	• E0071/2	• 349
• C0116	• 80	• E0022	• 331	• E0075	• 350
• C0117	• 76	• E0022	• 339	• E0076	• 350
• C0120	• 81	• E0022/1	• 339	• E0077	• 350
• C0120	• 81	• E0022/1	• 328	• E0078	• 350
• C0120/1	• 81	• E0022/1	• 331	• E0079	• 350
• C0120/2	• 81	• E0024	• 328	• E0079	• 350
• C0120/3	• 81	• E0024	• 339	• E0080	• 350
• C0120/4	• 81	• E0024	• 331	• E0080	• 350
• C0120/5	• 81	• E0024/1	• 339	• E0081	• 350
• C0120/6	• 81	• E0025	• 328	• E0082	• 350
• C0121	• 81	• E0025	• 331	• E0082/1	• 350
• C0122	• 81	• E0025	• 339	• E0082/2	• 350
• C0123	• 76	• E0025/1	• 339	• E0083	• 350
• C0124	• 79	• E0025/2	• 339	• E0084	• 350
• E0001	• 326	• E0025/3	• 339	• E0084/1	• 350
• E0001	• 330	• E0026	• 331	• E0088	• 346
• E0001	• 327	• E0026	• 328	• E0088/1	• 346
• E0002	• 326	• E0026	• 339	• E0092	• 351
• E0002	• 330	• E0029	• 339	• E0093/SDR	• 352
• E0002	• 327	• E0030	• 339	• E0094	• 352
• E0003	• 326	• E0031	• 339	• E0095	• 352
• E0003	• 327	• E0031/1	• 339	• E0096	• 352
• E0004	• 326	• E0031/2	• 339	• E0097	• 352
• E0010	• 334	• E0032	• 339	• E0098	• 352
• E0010	• 334	• E0032/1	• 339	• E0099	• 352
• E0011	• 334	• E0032/2	• 339	• E0100	• 352
• E0011	• 335	• E0032/3	• 339	• E0105	• 353
• E0012	• 334	• E0033	• 339	• E0106	• 353
• E0012	• 335	• E0034	• 339	• E0110	• 354
• E0013	• 334	• E0035	• 339	• E0111	• 354
• E0013	• 335	• E0051	• 341	• E0112	• 354
• E0014	• 334	• E0054	• 331	• E0115	• 355
• E0014	• 336	• E0055	• 331	• E0116	• 355
• E0015	• 334	• E0060	• 338	• E0145	• 356
• E0015	• 336	• E0060	• 338	• E0150	• 356
• E0016	• 334	• E0060	• 344	• E0151	• 356
• E0016	• 336	• E0064	• 344	• E0152	• 356
• E0017	• 338	• E0065	• 338	• E0153	• 356
• E0018	• 338	• E0065	• 338	• E0154	• 356
• E0018/1	• 338	• E0065	• 344	• E0155	• 356
• E0018/2	• 338	• E0065/1	• 344	• E0156	• 356
• E0018/3	• 338	• E0065/2	• 344	• E0157	• 356
• E0018/4	• 338	• E0065/3	• 344	• E0158	• 356

NAME	PAGE	NAME	PAGE	NAME	PAGE
• E0180	• 356	• H0111	• 94	• H0171	• 102
• E0180/1	• 356	• H0112	• 94	• H0200	• 106
• E0180/10	• 356	• H0115	• 94	• H0205/4	• 80
• E0180/2	• 356	• H0116	• 94	• H0206/1	• 108
• E0180/3	• 356	• H0120	• 95	• H0206/1	• 108
• E0180/4	• 356	• H0120/1	• 95	• H0206/1	• 108
• E0180/5	• 356	• H0120/2	• 95	• H0206/1	• 230
• E0180/6	• 356	• H0121	• 95	• H0206/1	• 284
• E0180/7	• 356	• H0121/1	• 95	• H0206/1	• 77
• E0180/8	• 356	• H0121/2	• 95	• H0206/2	• 80
• E0180/9	• 356	• H0121/3	• 95	• H0206/PLUS	• 77
• E0230	• 347	• H0121/4	• 95	• H0206/Plus	• 111
• E0231	• 347	• H0122	• 96	• H0206/PLUS	• 115
• E0232	• 347	• H0122/1	• 96	• H0206/PLUS	• 231
• H0001	• 84	• H0123	• 98	• H0206/PLUS	• 242
• H0001	• 84	• H0123/1	• 98	• H0206/PLUS	• 284
• H0002	• 84	• H0125	• 96	• H0208	• 284
• H0002 V	• 28	• H0126	• 97	• H0208	• 77
• H0003	• 84	• H0127	• 96	• H0208	• 231
• H0004	• 84	• H0129	• 97	• H0209	• 78
• H0004/2	• 84	• H0129/1	• 97	• H0209	• 79
• H0004/3	• 84	• H0130	• 97	• H0209	• 112
• H0005.	• 84	• H0133	• 99	• H0210	• 106
• H0009	• 85	• H0134	• 99	• H0211	• 108
• H0010	• 85	• H0139	• 100	• H0212	• 106
• H0010/1	• 85	• H0141	• 100	• H0213	• 109
• H0010/2	• 85	• H0142	• 100	• H0214	• 116
• H0011/1	• 85	• H0143	• 100	• H0220	• 106
• H0012	• 86	• H0144	• 100	• H0221	• 108
• H0013	• 85	• H0145	• 100	• H0222	• 106
• H0014	• 86	• H0146	• 100	• H0223	• 109
• H0015	• 86	• H0150	• 101	• H0224	• 117
• H0016	• 86	• H0150	• 40	• H0225	• 124
• H0016/1	• 86	• H0151	• 101	• H0230	• 107
• H0016/2	• 86	• H0152	• 101	• H0231	• 108
• H0017	• 87	• H0153	• 101	• H0232	• 107
• H0018	• 87	• H0154	• 101	• H0233	• 109
• H0018/1	• 87	• H0154	• 40	• H0234	• 117
• H0020	• 87	• H0155	• 101	• H0235	• 124
• H0021	• 87	• H0155	• 40	• H0235	• 132
• H0022	• 88	• H0156	• 101	• H0235	• 132
• H0025	• 88	• H0157	• 101	• H0235	• 134
• H0026	• 88	• H0158	• 101	• H0235	• 134
• H0027	• 89	• H0161	• 101	• H0235	• 136
• H0028	• 89	• H0161/1	• 101	• H0235	• 43
• H0030	• 89	• H0161/2	• 101	• H0235	• 42
• H0031	• 89	• H0161/3	• 101	• H0235	• 42
• H0032	• 89	• H0161/4	• 101	• H0235/2	• 43
• H0033	• 89	• H0165	• 102	• H0235/6	• 79
• H0034	• 89	• H0165/1	• 102	• H0235/6	• 43
• H0035	• 89	• H0165/2	• 102	• H0238/0	• 128
• H0036	• 89	• H0165/3	• 102	• H0240/1	• 129
• H0037	• 89	• H0166	• 102	• H0240/1	• 132
• H0046	• 90	• H0166/1	• 102	• H0240/1	• 134
• H0047	• 90	• H0166/1E	• 102	• H0240/1	• 42
• H0047/1	• 90	• H0166E	• 102	• H0240/2	• 129
• H0048	• 90	• H0167	• 102	• H0240/3	• 129
• H0049	• 90	• H0168	• 102	• H0240/4	• 129
• H0110	• 94	• H0169	• 102	• H0250	• 128

NAME	PAGE	NAME	PAGE	NAME	PAGE
• H0251	• 128	• H0405/2	• 144	• IE-2	• 156
• H0252	• 128	• H0406	• 144	• IE-T	• 156
• H0253	• 126	• H0407	• 144	• IE-W	• 156
• H0253	• 43	• H0408	• 144	• NDE 360 IE	• 156
• H0253/1	• 126	• H0409	• 145	• NDE 360 IR-1	• 157
• H0253/2	• 126	• H0409/1	• 145	• NDE 360 IR-1	• 157
• H0253/3	• 127	• H0409/2	• 145	• NDE 360 PS-1	• 157
• H0254	• 118	• H0409/3	• 145	• NDE 360 PS-1G	• 157
• H0254	• 134	• H0410	• 145	• NDE 360 SASW-G	• 155
• H0255	• 125	• H0411	• 145	• NDE 360 SASW-S	• 155
• H0256	• 127	• H0415	• 145	• NDE 360 SE/IR	• 157
• H0257	• 127	• H0460	• 158	• NDE 360 SE/IR	• 157
• H0258	• 128	• H0465	• 159	• NDE 360 SE/IR/PS-1.	• 157
• H0260	• 112	• H0466	• 159	• NDE 360 SE/IR/PS-1G	• 157
• H0261	• 112	• H0470	• 160	• NDE 360 SE-1	• 157
• H0270	• 137	• H0480	• 162	• NDE 360 SE-1	• 157
• H0271	• 137	• H0481	• 162	• NDE 360 SIR	• 156
• H0272	• 128	• H0482/C	• 164	• NDE 360 US	• 158
• H0280	• 137	• H0482/D	• 164	• P0001/1	• 6
• H0281	• 137	• H0482/U	• 164	• P0001/1	• 6
• H0290	• 128	• H0483	• 152	• P0001/2	• 6
• H0315	• 138	• H0484	• 153	• P0001/2	• 6
• H0316	• 138	• H0484/1	• 157	• P0001/3	• 6
• H0330	• 139	• H0484/2	• 157	• P0001/3	• 6
• H0330/1	• 139	• H0484/3	• 157	• P0001/4	• 6
• H0330/7	• 139	• H0484/4	• 156	• P0001/4	• 6
• H0331	• 139	• H0484/5	• 155	• P0003	• 6
• H0345	• 140	• H0484/6	• 155	• P0003	• 6
• H0346	• 140	• H0484/7 NDE 360 PS	• 157	• P0004	• 6
• H0350	• 140	• H0484/8	• 156	• P0004	• 6
• H0350/1	• 140	• H0484/9	• 158	• P0005	• 6
• H0351	• 140	• H0500	• 146	• P0005	• 6
• H0351/1	• 140	• H0501	• 146	• P0006	• 6
• H0360	• 141	• H0502	• 146	• P0006	• 6
• H0362	• 141	• H0505	• 146	• P0007	• 6
• H0367	• 142	• H0506	• 146	• P0007	• 6
• H0368	• 142	• H0507	• 146	• P0008	• 6
• H0369	• 141	• H0510	• 146	• P0008	• 6
• H0369	• 141	• H0511	• 146	• P0009	• 6
• H0375	• 142	• H0512	• 146	• P0009	• 6
• H0380	• 143	• H0515	• 146	• P0010	• 6
• H0380/1	• 143	• H0515/1	• 146	• P0010	• 6
• H0380/2	• 143	• H0515/2	• 146	• P0020	• 7
• H0385	• 150	• H0515/3	• 146	• P0020	• 7
• H0386	• 151	• H0515/4	• 146	• P0020/1	• 7
• H0387	• 151	• H0515/5	• 146	• P0020/1	• 7
• H0388/1	• 151	• H0516	• 146	• P0020/2	• 7
• H0388/2	• 151	• H0516/1	• 146	• P0020/2	• 7
• H0388/3	• 151	• H0560	• 42	• P0024	• 8
• H0388/4	• 151	• H0560	• 132	• P0024/1	• 8
• H0388/5	• 151	• H0561	• 132	• P0024/2	• 8
• H0388/6	• 151	• H0561	• 42	• P0024/3	• 8
• H0394	• 148	• H0562	• 132	• P0028	• 7
• H0394	• 41	• H0562	• 42	• P0028	• 7
• H0395	• 149	• H0563	• 132	• P0028/1	• 7
• H0396	• 149	• H0563	• 42	• P0028/1	• 7
• H0400	• 144	• H0564	• 132	• P0028/2	• 7
• H0405	• 144	• H0564	• 42	• P0028/2	• 7
• H0405/1	• 144	• IE-1	• 156	• P0030	• 8

NAME	PAGE	NAME	PAGE	NAME	PAGE
• P0030/1	• 8	• S0005/1	• 166	• S0040/1	• 173
• P0030/2	• 8	• S0005/2	• 166	• S0040/2	• 173
• P0032	• 6	• S0005/3	• 166	• S0040/3	• 173
• P0050	• 9	• S0005/4	• 166	• S0040/4	• 173
• P0060	• 9	• S0005/5	• 166	• S0041.	• 173
• P0062	• 9	• S0006	• 166	• S0043.	• 174
• P0090	• 9	• S0007	• 166	• S0043/1	• 174
• P0091	• 9	• S0008	• 166	• S0044	• 173
• P0092	• 9	• S0010	• 167	• S0044/1	• 173
• P0093	• 9	• S0011	• 167	• S0044/2	• 173
• P0100	• 9	• S0012	• 167	• S0047	• 174
• P0101	• 9	• S0013	• 167	• S0047	• 174
• P0102	• 9	• S0014	• 167	• S0047/1	• 174
• P0154	• 10	• S0015	• 167	• S0047/2	• 174
• P0163/1	• 10	• S0016	• 167	• S0047/3	• 174
• P0163/10	• 10	• S0017	• 186	• S0047/3	• 175
• P0163/11	• 10	• S0017	• 167	• S0048	• 175
• P0163/12	• 10	• S0020	• 168	• S0048/1	• 175
• P0163/13	• 10	• S0020	• 168	• S0048/2	• 175
• P0163/14	• 10	• S0021	• 168	• S0048/3	• 175
• P0163/2	• 10	• S0021	• 168	• S0049	• 175
• P0163/3	• 10	• S0023	• 63	• S0050	• 176
• P0163/4	• 10	• S0023	• 168	• S0051	• 176
• P0163/5	• 10	• S0024	• 169	• S0052	• 176
• P0163/6	• 10	• S0024	• 281	• S0053.	• 176
• P0163/7	• 10	• S0025	• 169	• S0054	• 176
• P0163/8	• 10	• S0025	• 170	• S0056	• 176
• P0163/9	• 10	• S0025/1	• 169	• S0056/1	• 176
• P0200	• 11	• S0025/2	• 169	• S0057	• 176
• P0201	• 11	• S0025/3	• 169	• S0058	• 176
• P0202	• 11	• S0025/4	• 169	• S0060	• 177
• P0203	• 11	• S0025/5	• 169	• S0060	• 177
• P0204	• 11	• S0025/6	• 169	• S0060/1	• 177
• P0205	• 11	• S0025/7	• 169	• S0060/2.	• 177
• P0206	• 11	• S0026/1	• 170	• S0060/3.	• 177
• P0207	• 11	• S0026/10	• 170	• S0060/4	• 177
• P0208	• 11	• S0026/2	• 170	• S0060/5	• 177
• P0220	• 12	• S0026/3	• 170	• S0060/6	• 177
• P0221	• 12	• S0026/4	• 170	• S0060/7.	• 177
• P0222	• 12	• S0026/5	• 170	• S0060/8	• 177
• P0223	• 12	• S0026/6	• 170	• S0060/9	• 177
• P0224	• 12	• S0026/7	• 170	• S0061	• 177
• P0225	• 12	• S0026/8	• 170	• S0062	• 177
• P0226	• 12	• S0026/9	• 170	• S0063	• 177
• P0227	• 12	• S0029/2	• 188	• S0065	• 178
• P0228	• 12	• S0030	• 170	• S0065	• 178
• P0229	• 12	• S0030/1	• 170	• S0066	• 178
• P0250	• 14	• S0030/1	• 170	• S0066	• 178
• P0254	• 14	• S0030/2.	• 170	• S0068	• 178
• P0255	• 14	• S0030/2.	• 170	• S0069	• 178
• S0001	• 166	• S0030/3	• 170	• S0071	• 178
• S0001/1	• 166	• S0030/4	• 170	• S0071	• 178
• S0001/1	• 166	• S0030/5	• 170	• S0072	• 178
• S0001/2	• 166	• S0031	• 170	• S0075	• 178
• S0001/3	• 166	• S0032	• 171	• S0076	• 178
• S0002	• 166	• S0032/1	• 171	• S0081	• 178
• S0003	• 166	• S0033 (S 2000)	• 171	• S0085	• 179
• S0004	• 166	• S0034 (L 2000)	• 171	• S0085/1	• 179
• S0005	• 166	• S0040	• 173	• S0086	• 179

NAME	PAGE	NAME	PAGE	NAME	PAGE
• S0087	• 179	• S0152	• 195	• S0237/0	• 184
• S0090	• 180	• S0153	• 195	• S0237/0	• 184
• S0093.	• 180	• S0155	• 200	• S0237/0	• 188
• S0094.	• 180	• S0155/1	• 200	• S0237/0	• 188
• S0096	• 180	• S0166	• 199	• S0237/1	• 188
• S0098	• 181	• S0167	• 200	• S0237/1	• 286
• S0098	• 181	• S0169	• 208	• S0237/1	• 242
• S0098/1.	• 181	• S0169/1	• 208	• S0237/4	• 286
• S0098/2	• 181	• S0169/2	• 208	• S0237/4	• 242
• S0100	• 181	• S0170	• 208	• S0238	• 194
• S0105	• 184	• S0175	• 194	• S0238/0	• 188
• S0105	• 184	• S0176	• 194	• S0238/1	• 188
• S0105	• 188	• S0181	• 207	• S0238/4	• 184
• S0105	• 182	• S0200	• 184	• S0238/4	• 184
• S0107	• 182	• S0200	• 184	• S0238/4	• 188
• S0108	• 182	• S0200	• 188	• S0238/5	• 184
• S0109	• 182	• S0200	• 188	• S0238/5	• 184
• S0109/1	• 182	• S0200	• 286	• S0238/5	• 188
• S0109/2	• 182	• S0200	• 134	• S0239	• 194
• S0109/3	• 182	• S0200	• 208	• S0239/1	• 194
• S0109/4	• 182	• S0200	• 242	• S0240	• 194
• S0109/5	• 182	• S0200	• 43	• S0250/1	• 220
• S0109/6	• 182	• S0200/1	• 184	• S0250/2	• 217
• S0109/7	• 182	• S0200/1	• 188	• S0250/2	• 220
• S0120	• 184	• S0219	• 201	• S0251	• 220
• S0121	• 184	• S0219/1	• 202	• S0252	• 220
• S0125	• 185	• S0219/2	• 202	• S0254/1	• 84
• S0126	• 185	• S0219/3	• 202	• S0254/1	• 85
• S0126	• 189	• S0220	• 203	• S0254/1	• 217
• S0126/1	• 185	• S0220/1	• 204	• S0254/2	• 217
• S0126/2	• 185	• S0220/1D	• 206	• S0256/2	• 217
• S0126/3	• 185	• S0220/2	• 203	• S0256/3	• 219
• S0126/4	• 185	• S0220/3	• 204	• S0258/1	• 217
• S0126/5	• 185	• S0220/3D	• 206	• S0258/2	• 217
• S0126/6	• 185	• S0220/5	• 205	• S0260/1	• 217
• S0127	• 185	• S0220/6	• 205	• S0260/2	• 217
• S0127/1	• 185	• S0225	• 207	• S0262/1	• 220
• S0128	• 185	• S0226	• 207	• S0262/1	• 218
• S0128/1	• 185	• S0231	• 184	• S0262/2	• 220
• S0128/2	• 185	• S0231	• 188	• S0262/2	• 218
• S0129	• 185	• S0231	• 209	• S0262/3	• 220
• S0133	• 189	• S0231	• 210	• S0262/3	• 218
• S0137	• 189	• S0232	• 183	• S0264	• 220
• S0138	• 189	• S0232	• 209	• S0269/1	• 218
• S0140	• 189	• S0232.	• 184	• S0269/2	• 218
• S0140/1	• 189	• S0233	• 187	• S0269/3	• 219
• S0140/2	• 189	• S0233	• 188	• S0270	• 219
• S0150	• 193	• S0233	• 209	• S0271	• 219
• S0150/1	• 193	• S0234	• 209	• S0272	• 219
• S0150/2	• 193	• S0235	• 285	• S0273	• 219
• S0150/3	• 208	• S0235	• 209	• S0274/1	• 218
• S0151	• 195	• S0235	• 232	• S0274/2	• 218
• S0151	• 243	• S0235E	• 286	• S0274/3	• 218
• S0151/20	• 198	• S0235E	• 242	• S0276/1	• 218
• S0151/20/P	• 198	• S0236	• 209	• S0276/2	• 218
• S0151/21	• 199	• S0236	• 232	• S0276/3	• 218
• S0151/39	• 199	• S0237	• 128	• S0276/4	• 219
• S0151/40	• 198	• S0237	• 134	• S0279/1	• 218
• S0151/8	• 198	• S0237	• 43	• S0279/2	• 218



NAME	PAGE	NAME	PAGE	NAME	PAGE
• S0279/3	• 218	• S0398	• 246	• S0504	• 258
• S0283	• 220	• S0400	• 246	• S0504	• 251
• S0290	• 221	• S0401	• 246	• S0504/1	• 258
• S0290/1	• 223	• S0402	• 246	• S0504/1	• 251
• S0290/2	• 223	• S0405	• 246	• S0504/2	• 258
• S0290/3	• 223	• S0410	• 247	• S0505	• 259
• S0290/4	• 223	• S0410/1	• 247	• S0506	• 259
• S0290/5	• 223	• S0410/2	• 247	• S0507	• 260
• S0290/6	• 223	• S0410/3	• 247	• S0509	• 260
• S0290/7	• 223	• S0414	• 247	• S0510	• 260
• S0293	• 225	• S0417	• 248	• S0511	• 260
• S0293	• 282	• S0418	• 248	• S0511	• 260
• S0294	• 282	• S0419	• 248	• S0512	• 260
• S0294	• 225	• S0419/1	• 248	• S0515	• 261
• S0295	• 282	• S0420	• 248	• S0525	• 261
• S0295	• 225	• S0421	• 248	• S0527	• 262
• S0296	• 225	• S0423	• 249	• S0528	• 262
• S0297	• 225	• S0424	• 249	• S0529	• 262
• S0298	• 225	• S0425	• 249	• S0529/1	• 262
• S0299	• 225	• S0426	• 249	• S0529/6	• 263
• S0299	• 282	• S0427	• 249	• S0530	• 263
• S0348.	• 228	• S0428	• 249	• S0531	• 263
• S0349	• 228	• S0429	• 249	• S0532	• 263
• S0350	• 228	• S0430	• 249	• S0535	• 263
• S0351	• 228	• S0435	• 249	• S0538	• 264
• S0352	• 229	• S0438	• 249	• S0539	• 264
• S0352	• 242	• S0441	• 249	• S0543	• 264
• S0352	• 246	• S0447	• 249	• S0543/1	• 264
• S0355	• 229	• S0448	• 249	• S0543/2	• 264
• S0357	• 284	• S0449	• 249	• S0544	• 266
• S0358	• 284	• S0452	• 249	• S0545	• 265
• S0365	• 241	• S0453	• 249	• S0546	• 265
• S0365	• 238	• S0470	• 249	• S0546D	• 266
• S0366	• 241	• S0475/MC-3-82	• 253	• S0547	• 266
• S0366	• 238	• S0476/MC-3-81	• 253	• S0548	• 267
• S0367	• 241	• S0480/1	• 258	• S0549	• 268
• S0367	• 238	• S0480/2	• 258	• S0552	• 268
• S0367/1	• 241	• S0480/3	• 258	• S0553	• 269
• S0367/1	• 238	• S0480/7	• 258	• S0561	• 269
• S0368	• 239	• S0480/9	• 258	• S0562	• 269
• S0369	• 239	• S0480/MC-3-122	• 253	• S0563	• 269
• S0370	• 239	• S0481/MC-3-121	• 253	• S0564	• 269
• S0370/1	• 239	• S0485/MC-1DR-82	• 254	• S129/1	• 185
• S0371	• 240	• S0486/MC-1DR-81	• 254	• S129/2	• 185
• S0372	• 240	• S0487/MC-1DR-122	• 254	• S292	• 224
• S0373	• 132	• S0488/MC-1DR-121	• 254	• SASW-G2	• 155
• S0373	• 134	• S0489	• 258	• SASW-G4	• 155
• S0373	• 241	• S0489/1	• 258	• SASW-G8	• 155
• S0373	• 43	• S0489/2	• 258	• SASW-S.	• 155
• S0373	• 42	• S0490/MC-5-24	• 255	• SASW-S+G	• 155
• S0373/1	• 241	• S0491	• 258	• SIR-1	• 156
• S0374	• 241	• S0495	• 258	• UPV-1S	• 149
• S0374/1	• 241	• S0496	• 258	• US-1	• 158
• S0380/0	• 184	• S0499	• 258	• V0 003	• 358
• S0390	• 246	• S0500/MCM-2	• 257	• V0001	• 358
• S0394	• 246	• S0501	• 258	• V0002	• 358
• S0395	• 246	• S0502	• 258	• V0004	• 186
• S0396	• 246	• S0502/1	• 258	• V0004	• 358
• S0397	• 246	• S0503	• 258	• V0004	• 186

NAME	PAGE	NAME	PAGE	NAME	PAGE
• V0005	• 283	• V0029	• 193	• V0118	• 359
• V0005	• 358	• V0029	• 194	• V0119	• 359
• V0005	• 229	• V0029/1	• 193	• V0120	• 359
• V0006	• 283	• V0029/1	• 194	• V0120/1	• 359
• V0006	• 358	• V0029/2	• 193	• V0120/2	• 359
• V0006	• 229	• V0029/2.	• 194	• V0120/3	• 359
• V0007	• 283	• V0029/3	• 193	• V0123	• 359
• V0007	• 358	• V0029/3.	• 194	• V0125	• 13
• V0007	• 358	• V0030	• 242	• V0125	• 360
• V0007	• 241	• V0030	• 242	• V0126	• 13
• V0007	• 246	• V0030	• 286	• V0126	• 360
• V0008	• 358	• V0030	• 229	• V0127	• 360
• V0008	• 358	• V0030	• 242	• V0128	• 360
• V0008	• 241	• V0030	• 283	• V0130	• 360
• V0009	• 358	• V0030	• 358	• V0130/1	• 181
• V0009	• 358	• V0030.	• 229	• V0130/1	• 13
• V0009	• 241	• V0034	• 249	• V0130/1	• 360
• V0010	• 358	• V0035	• 249	• V0130/1	• 360
• V0010	• 358	• V0037	• 249	• V0130/2	• 13
• V0011	• 358	• V0038	• 249	• V0130/2	• 360
• V0011	• 358	• V0039	• 249	• V0130/3	• 13
• V0015	• 186	• V0040	• 249	• V0135	• 181
• V0015	• 358	• V0041	• 249	• V0135	• 181
• V0015	• 62	• V0042	• 249	• V0135	• 261
• V0015	• 186	• V0043	• 46	• V0135	• 360
• V0016	• 283	• V0043	• 46	• V0136	• 181
• V0016	• 358	• V0043.	• 249	• V0136	• 360
• V0016	• 182	• V0043/1	• 46	• V0136/1	• 360
• V0016	• 186	• V0044	• 249	• V0136/2	• 360
• V0016	• 229	• V0045	• 249	• V0136/3	• 360
• V0016	• 229	• V0046	• 249	• V0136/4	• 360
• V0016	• 242	• V0047	• 84	• V0149	• 361
• V0016	• 242	• V0047	• 85	• V0150	• 361
• V0016	• 34	• V0049	• 249	• V0152	• 361
• V0017	• 186	• V0050	• 249	• V0153/1	• 361
• V0017	• 358	• V0051	• 249	• V0153/2	• 361
• V0017	• 186	• V0067	• 178	• V0153/3	• 361
• V0017	• 242	• V0069	• 46	• V0155	• 362
• V0017	• 242	• V0070	• 177	• V0155/1	• 362
• V0017	• 246	• V0070	• 84	• V0155/2	• 362
• V0018	• 242	• V0070	• 85	• V0155/3	• 362
• V0018	• 358	• V0070	• 178	• V0155/4	• 362
• V0018	• 242	• V0070	• 178	• V0155/5	• 362
• V0019	• 358	• V0076	• 58	• V0156	• 97
• V0023	• 62	• V0077	• 58	• V0156	• 362
• V0023/1	• 62	• V0079	• 58	• V0156/1	• 362
• V0024	• 186	• V0105	• 359	• V0156/2	• 97
• V0024	• 358	• V0106	• 359	• V0156/2	• 362
• V0024	• 186	• V0107	• 359	• V0156/3	• 97
• V0024	• 34	• V0108	• 359	• V0157	• 362
• V0025	• 283	• V0115	• 359	• V0157/1	• 362
• V0025	• 229	• V0115/1	• 359	• V0157/2	• 362
• V0025	• 229	• V0115/2	• 359	• V0157/3	• 362
• V0025	• 358	• V0115/3	• 359	• V0157/4	• 362
• V0026	• 241	• V0116	• 359	• V0161	• 84
• V0027	• 241	• V0117	• 359	• V0162/2	• 177
• V0028	• 193	• V0117/1	• 359	• V0190	• 363
• V0028	• 194	• V0117/2	• 359	• V0190	• 26
• V0028	• 241	• V0117/3	• 359	• V0191	• 304

NAME	PAGE	NAME	PAGE	NAME	PAGE
• V0191	• 304	• V0263	• 364	• V1016	• 305
• V0191	• 363	• V0265	• 26	• V1065	• 368
• V0191	• 261	• V0266	• 26	• V1066	• 368
• V0192	• 363	• V0269	• 261	• V1067	• 368
• V0193	• 363	• V0285	• 365	• V1068	• 368
• V0195	• 363	• V0286	• 365	• V1069	• 368
• V0196	• 363	• V0287	• 365	• V1070	• 368
• V0197	• 363	• V0288	• 365	• V1071	• 368
• V0198	• 363	• V0290	• 304	• V1073	• 368
• V0199	• 363	• V0290	• 304	• V1082	• 368
• V0200	• 99	• V0290	• 304	• V1083	• 368
• V0200/A	• 99	• V0290	• 305	• V1084	• 368
• V0205	• 363	• V0310	• 365	• V1085	• 368
• V0206	• 363	• V0315	• 365	• V1086	• 368
• V0207	• 305	• V0316	• 365	• V1087	• 368
• V0207	• 363	• V0317	• 365	• V1088	• 368
• V0208	• 273	• V0320	• 365	• V1089	• 368
• V0208	• 276	• V0340	• 365	• V1090	• 368
• V0208	• 363	• V0341	• 365	• V1091	• 368
• V0209	• 363	• V0350	• 366	• V1092	• 368
• V0210	• 363	• V0351	• 366	• V1093	• 368
• V0215	• 363	• V0352	• 366	• V1094	• 368
• V0216	• 363	• V0355	• 366	• V1095	• 368
• V0217	• 363	• V0356	• 366	• V1096	• 368
• V0220	• 363	• V0357	• 366	• V1097	• 368
• V0221	• 363	• V0358	• 366	• V1098	• 368
• V0222	• 363	• V0359	• 366	• V1100	• 368
• V0223	• 304	• V0370	• 366	• V1101	• 368
• V0223	• 304	• V0371	• 366	• V1102	• 368
• V0223	• 363	• V0372	• 366	• V1103	• 368
• V0224	• 363	• V0373	• 366	• V1104	• 368
• V0230	• 363	• V0375	• 367	• V1105	• 368
• V0231	• 363	• V0376	• 367	• V1106	• 368
• V0232	• 363	• V0377	• 367	• V1107	• 368
• V0235	• 364	• V0378	• 367	• V1110	• 368
• V0236	• 364	• V0379	• 367	• V1111	• 368
• V0237	• 364	• V0380	• 367	• V1112	• 368
• V0238	• 364	• V0385	• 367	• V1113	• 368
• V024	• 174	• V0386	• 367	• V1114	• 368
• V0240	• 364	• V0387	• 367	• V1116	• 368
• V0241	• 364	• V0388	• 367	• V1117	• 368
• V0242	• 364	• V0389	• 367	• V1118	• 368
• V0243	• 364	• V0390	• 367	• V1119	• 368
• V0246	• 364	• V0391	• 367	• V1120	• 368
• V0247	• 364	• V0410	• 274	• V1121	• 368
• V0248	• 173	• V0410	• 367	• V1122	• 368
• V0248	• 175	• V0411	• 367	• V1123	• 368
• V0248	• 364	• V0912	• 305	• V1124	• 368
• V0249	• 364	• V0914	• 305	• V1125	• 368
• V0250	• 364	• V0918	• 178	• V1126	• 368
• V0251	• 364	• V0966	• 31	• V1127	• 368
• V0252	• 364	• V1002	• 368	• V1128	• 368
• V0253	• 364	• V1003	• 368	• V1129	• 368
• V0255	• 364	• V1005	• 26	• V1553	• 26
• V0257	• 364	• V1007	• 304	• V2320	• 370
• V0258	• 364	• V1008	• 304	• V2320/1	• 370
• V0260	• 364	• V1008	• 304	• V2320/2	• 370
• V0261	• 364	• V1013	• 303	• V2325	• 370
• V0262	• 364	• V1015	• 305	• V2325/1	• 370

NAME	PAGE	NAME	PAGE	NAME	PAGE
• V2325/2	• 370	• V6358	• 369	• V6581/A	• 371
• V2330	• 370	• V6359	• 369	• V6582	• 371
• V2330/1	• 370	• V6359	• 369	• V6582/A	• 371
• V2330/2	• 370	• V6360	• 369	• V6583	• 371
• V2340	• 370	• V6360	• 369	• V6583/A	• 371
• V2340/1	• 370	• V6361	• 369	• V6584	• 371
• V2340/2	• 370	• V6361	• 369	• V6584/A	• 371
• V2350	• 370	• V6361	• 28	• V6585	• 371
• V2350/1	• 370	• V6362	• 369	• V6585/A	• 371
• V2350/2	• 370	• V6362	• 369	• V6586	• 371
• V2360	• 370	• V6363	• 369	• V6586/A	• 371
• V2360/1	• 370	• V6363	• 369	• V6620	• 370
• V2360/2	• 370	• V6363	• 27	• V6622	• 370
• V2370	• 370	• V6364	• 369	• V6623	• 370
• V2370/1	• 370	• V6364	• 369	• V6624	• 370
• V2370/2	• 370	• V6365	• 369	• V6625	• 370
• V2380	• 370	• V6365	• 369	• V6626	• 370
• V2380/1	• 370	• V6420	• 369	• V6627	• 370
• V2380/2	• 370	• V6421	• 369	• V6628	• 370
• V2390	• 370	• V6422	• 369	• V6629	• 370
• V2390/1	• 370	• V6423	• 369	• V6630	• 370
• V2390/2	• 370	• V6424	• 369	• V6660	• 371
• V5560	• 370	• V6425	• 369	• V6660/A	• 371
• V5561	• 302	• V6426	• 369	• V6661	• 371
• V5561	• 370	• V6427	• 369	• V6662	• 371
• V5561.	• 175	• V6428	• 369	• V6662/A	• 371
• V5562	• 370	• V6430	• 369	• V6663	• 371
• V5562	• 28	• V6431	• 369	• V6664	• 371
• V5562.	• 175	• V6432	• 369	• V6665	• 371
• V5563	• 370	• V6433	• 369	• V6665/A	• 371
• V5563	• 175	• V6434	• 369	• V6666	• 371
• V5570	• 370	• V6435	• 369	• V6666/A	• 371
• V5571	• 370	• V6436	• 369	• V6667	• 371
• V5572	• 370	• V6437	• 369	• V6667/A	• 371
• V5572	• 28	• V6438	• 369	• V6668	• 371
• V5573	• 370	• V6439	• 369	• V6668/A	• 371
• V5580	• 370	• V6470	• 372	• V6669	• 371
• V5581	• 370	• V6471	• 372	• V6669/A	• 371
• V5582	• 370	• V6473	• 372	• V6670	• 371
• V5583	• 370	• V6474	• 372	• V6670/A	• 371
• V6160	• 370	• V6475	• 372	• V6720	• 371
• V6161	• 370	• V6476	• 372	• V6721	• 371
• V6162	• 370	• V6560	• 369	• V6722	• 371
• V6163	• 370	• V6560/A	• 369	• V6723	• 371
• V6164	• 370	• V6561	• 369	• V6724	• 371
• V6180	• 370	• V6561/A	• 369	• V6725	• 371
• V6181	• 370	• V6562	• 369	• V6726	• 371
• V6182	• 370	• V6562/A	• 369	• V6727	• 371
• V6183	• 370	• V6563	• 369	• V6728	• 371
• V6184	• 370	• V6563/A	• 369	• V6740	• 371
• V6200	• 369	• V6564	• 369	• V6741	• 371
• V6201	• 369	• V6564/A	• 369	• V6742	• 371
• V6202	• 369	• V6565	• 369	• V6742	• 175
• V6203	• 369	• V6565/A	• 369	• V6743	• 371
• V6204	• 369	• V6566	• 369	• V6744	• 371
• V6260	• 370	• V6566/A	• 369	• V6745	• 371
• V6261	• 370	• V6580	• 371	• V6746	• 371
• V6262	• 370	• V6580/A	• 371	• V6747	• 371
• V6358	• 369	• V6581	• 371	• V6747	• 178



NAME	PAGE	NAME	PAGE	NAME	PAGE
• V6748	• 371	• V7038	• 368	• V8050	• 372
• V6780	• 371	• V7039	• 368	• V8060	• 372
• V6781	• 371	• V7040	• 368	• V8070	• 372
• V6782	• 371	• V7042	• 368	• V8208/1	• 373
• V6783	• 371	• V7044	• 368	• V8208/2	• 373
• V6784	• 371	• V7045	• 368	• V8208/3	• 373
• V6785	• 371	• V7046	• 368	• V8208/4	• 174
• V6786	• 371	• V7047	• 368	• V8208/4	• 373
• V6787	• 371	• V7049	• 368	• V8208/5	• 373
• V6788	• 371	• V7052	• 368	• V8212/0	• 372
• V6789	• 371	• V7054	• 368	• V8212/1	• 372
• V6790	• 371	• V7056	• 368	• V8212/1a	• 372
• V6799	• 371	• V7057	• 368	• V8212/1b	• 372
• V6799	• 372	• V7058	• 368	• V8212/2	• 372
• V6800	• 371	• V7059	• 368	• V8212/2a	• 372
• V6800	• 372	• V7060	• 368	• V8212/3	• 372
• V6801	• 371	• V7062	• 368	• V8212/3a	• 372
• V6801	• 372	• V7063	• 368	• V8212/4	• 372
• V6802	• 371	• V7064	• 368	• V8212/5	• 372
• V6802	• 372	• V7067	• 368	• V8212/6	• 372
• V6803	• 371	• V7070	• 368	• V8212/7	• 372
• V6803	• 372	• V7071	• 368	• V8212/8	• 372
• V6804	• 371	• V7072	• 368	• V8274/1	• 373
• V6804	• 372	• V7073	• 368	• V8274/1a	• 373
• V6804	• 178	• V7074	• 368	• V8274/2	• 373
• V6804	• 261	• V7075	• 368	• V8274/3	• 373
• V6805	• 371	• V7076	• 368	• V8274/4	• 373
• V6805	• 372	• V7077	• 368	• V8274/5	• 373
• V6806	• 371	• V7078	• 368	• V8274/6	• 373
• V6806	• 372	• V7079	• 368	• V8274/7	• 175
• V6806	• 26	• V7553	• 261	• V8274/7	• 373
• V6807	• 371	• V7750	• 372	• V8274/8	• 373
• V6807	• 372	• V7751	• 372	• V8274/9	• 373
• V6808	• 371	• V7752	• 372	• V8274/9a	• 373
• V6808	• 372	• V7753	• 372	• V8667	• 369
• V6809	• 371	• V7755	• 372	• V8667/A	• 369
• V6809	• 372	• V7756	• 372	• V8687	• 371
• V6810	• 371	• V7757	• 372	• V8687/A	• 371
• V6810	• 372	• V7758	• 372	• V9994	• 65
• V6811	• 371	• V8001/30	• 372	• V9994/1	• 65
• V7001	• 368	• V8001/35	• 372	• V9994/2	• 65
• V7005	• 368	• V8001/40	• 372	• V9994/3	• 65
• V7006	• 368	• V8001/45	• 372		
• V7007	• 368	• V8001/50	• 372		
• V7008	• 368	• V8002/35	• 372		
• V7009	• 368	• V8002/40	• 372		
• V7020	• 368	• V8002/45	• 372		
• V7022	• 368	• V8002/50	• 372		
• V7023	• 368	• V8002/60	• 372		
• V7024	• 368	• V8002/70	• 372		
• V7025	• 368	• V8003/30	• 372		
• V7026	• 368	• V8003/35	• 372		
• V7027	• 368	• V8003/40	• 372		
• V7027	• 368	• V8003/45	• 372		
• V7033	• 368	• V8003/50	• 372		
• V7034	• 368	• V8030	• 372		
• V7035	• 368	• V8035	• 372		
• V7036	• 368	• V8040	• 372		
• V7037	• 368	• V8045	• 372		



Notes



Lined area for taking notes, consisting of many horizontal lines.