

Persianas Lamas Orientables / Aluminio
Persiennes Lames Orientables / Aluminium
Movable Blades Shutters / Aluminium

ALUMINIO | ALUMINIUM | ALUMINIUM

laminas orientables | lames orientables | movable blades

Movil Clasico T140

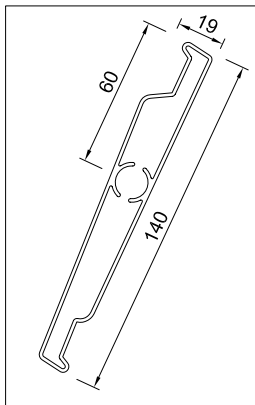

Movil Clasico T110

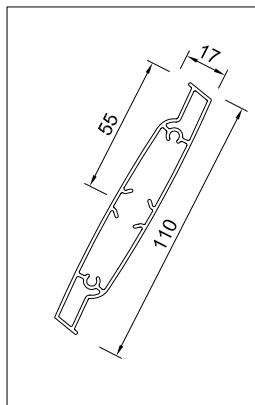

Movil Clasico T80

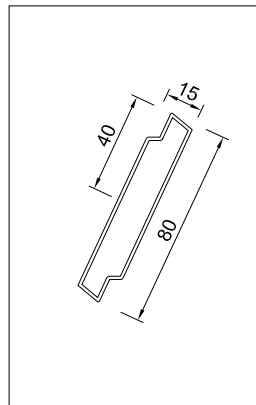

Alba Clasic 70MG

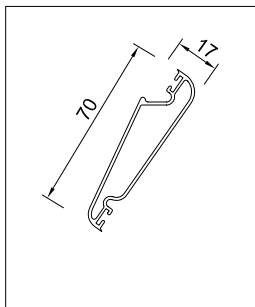

Alba Clasic 60M

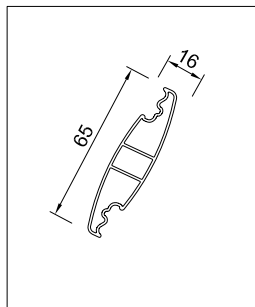

Alba Disseny ALT70

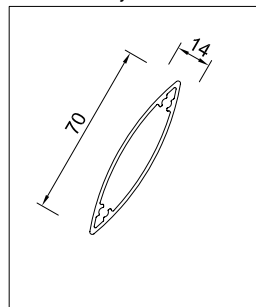

ALUMINIO | ALUMINIUM | ALUMINIUM

laminas orientables | *lames orientables* | movable blades

modelos | *modèles* | models

bastidor <i>cadre</i> frame	lama <i>lame</i> blade	modelos <i>modèles</i> models	E	soluciones constructivas <i>solutions constructives</i> constructive solutions	posición lama <i>position lame</i> blade position		ancho max lama <i>longueur max lame</i> max lenght blade		opciones <i>options</i> options			
					H	V	H	V	paso variable <i>pas variable</i> variable pitch	testeros <i>embouts</i> endplates		accionamiento <i>commande</i> operation
										ALU	PA6	
40N.C	T80	T80/40N.C	40mm	■	✓	✓	1600	2000	↕		●	👤 ⚙️ ⚡
	T110	T110/40N.C	40mm	■	✓	✓	1800	2100	↕	●	●	👤 ⚙️ ⚡
	T140	T140/40N.C	40mm	■	✓	✓	2000	2200	↕	●	●	👤 ⚙️ ⚡
	ALT70	ALT70/40N.C	40mm	■	✓	✓	1600	2000	↕		●	👤 ⚙️ ⚡
60N.C	T80	T80/60N.C	40mm	■	✓	✓	1600	2000	↕		●	👤 ⚙️ ⚡
	T110	T110/60N.C	40mm	■	✓	✓	1800	2100	↕	●	●	👤 ⚙️ ⚡
	T140	T140/60N.C	40mm	■	✓	✓	2000	2200	↕	●	●	👤 ⚙️ ⚡
	ALT70	ALT70/60N.C	40mm	■	✓	✓	1600	2000	↕		●	👤 ⚙️ ⚡
40SC.C	T80	T80/40SC.C	40mm	●	✓	✓	1600	2000	↕		●	👤 ⚙️ ⚡
	T110	T110/40SC.C	40mm	●	✓	✓	1800	2100	↕	●	●	👤 ⚙️ ⚡
	T140	T140/40SC.C	40mm	●	✓	✓	1600	2100	↕	●	●	👤 ⚙️ ⚡
	ALT70	ALT70/40SC.C	40mm	●	✓	✓	1600	2000	↕		●	👤 ⚙️ ⚡
60SC.C	T80	T80/60SC.C	40mm	●	✓	✓	1600	2000	↕		●	👤 ⚙️ ⚡
	T110	T110/60SC.C	40mm	●	✓	✓	1800	2100	↕	●	●	👤 ⚙️ ⚡
	T140	T140/60SC.C	40mm	●	✓	✓	1600	2100	↕	●	●	👤 ⚙️ ⚡
	ALT70	ALT70/60SC.C	40mm	●	✓	✓	1600	2000	↕		●	👤 ⚙️ ⚡
60AB	60M	60M/60AB	40mm	●	✓	✓	1200	1200			●	👤 ⚡
	70MG	70MG/60AB	40mm	●	✓	✓	1200	1200			●	👤 ⚡

* Ancho máximo sin travesaños vertical | * *largeur max sans montant central* | * maximum width without vertical transom

E= espesor bastidor | *épaisseur de cadre* | frame thickness

soluciones constructivas | *solutions constructives* | constructive solutions

■ marco fijo | *cadre fixe* | fixed frame

▲ fijo y corredera | *fixe & coulissant* | fixe & sliding

● todas | *tous* | all

👤 manual | *manuelle* | manualy

⚙️ mecánico | *mécanique* | mechanical

⚡ motor | *moteur* | motor

ALUMINIO | ALUMINIUM | ALUMINIUM
laminas orientables | lames orientables | movable blades

T140



T110



T80



ALT70



70MG



60M



ALUMINIO | ALUMINIUM | ALUMINIUM
 lamas orientables | lames orientables | movable blades

cotas principales
 dimensions principales
 main dimensions

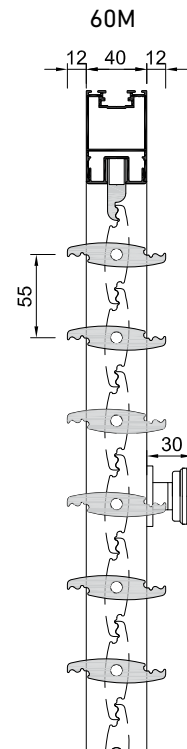
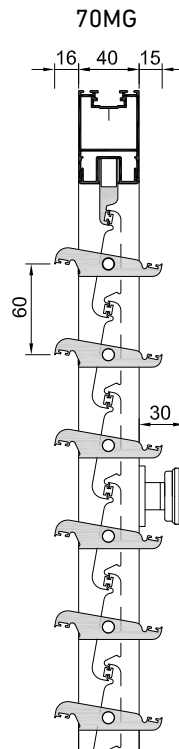
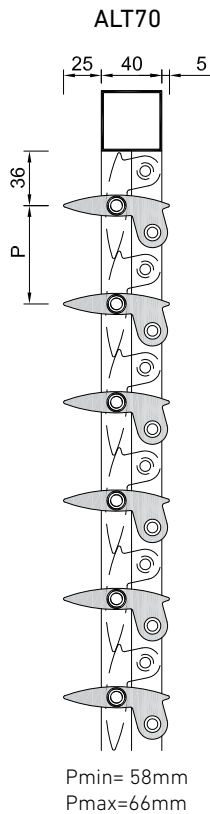
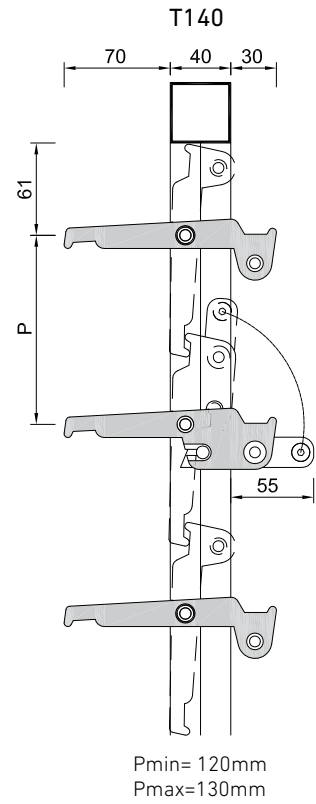
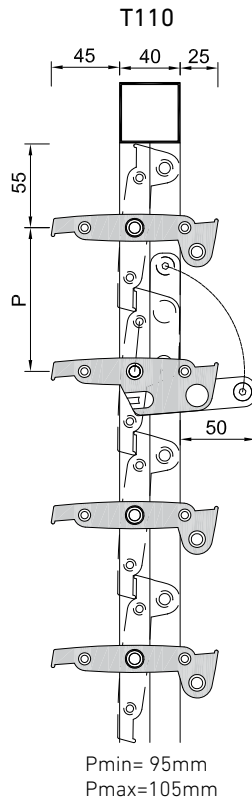
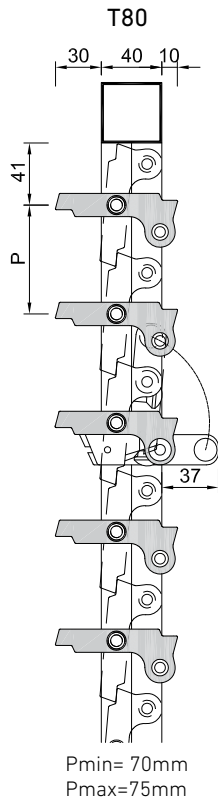

ALUMINIO | ALUMINIUM | ALUMINIUM
laminas orientables | lames orientables | movable blades

ALT70



T80



T110



T140



ALT70



T80



T110



T140





T80/40N.C



T110/60N.C





T140/60N.C



T140/60SC.C